



H2W2PC1M

Network WDR 2MP People Counting Camera







OPERATIONAL	
VIDEO STANDARD	NTSC/PAL
SCANNING SYSTEM	Progressive
IMAGE SENSOR	1/2.8" 2Megapixel progressive scan CMOS
NUMBER OF PIXELS (H x V)	1920(H) x 1080(V)
MINIMUM ILLUMINATION	0.08Lux/F2.0(Color,30IRE) 0.04Lux/F2.0(B/W,30IRE)
S/N RATIO	More than 45dB
ELECTRONIC SHUTTER SPEED	1/3~1/100000s
IR DISTANCE	N/A
DAY/NIGHT	Auto(ICR) / Color / B/W
BACKLIGHT COMPENSATION	BLC / HLC / WDR
WHITE BALANCE	Auto/Natural/Street Lamp/Outdoor/Manual/ Customized Region
GAIN CONTROL	0~100
WIDE DYNAMIC RANGE	120dB
NOISE REDUCTION	3D DNR
PRIVACY MASKING	Off / On (4 Areas, Rectangle)
MOTION DETECTION	Off / On (4 Zones Rectangle)
REGION OF INTEREST	Off / On (4 Zones)
FACE DETECTION	Supported
AUDIO DETECTION	Supported
PEOPLE COUNTING	Supported
LENS	2.1mm, F2.0 Fixed, Board-in
ANGLE OF VIEW	H: 128°, V:70°
VIDEO	
VIDEO COMPRESSION	H.265/H.264H/Smart Codec/MJPEG (Sub Stream)
RESOLUTION	1080P(1920x1080)/1.3M(1280x960)/ 720P(1280x720)/D1(704x480/576)/ CIF(352x240/288)
FRAME RATE	Main Stream: 1080P (1~50/60fps) Sub Stream: D1(1~50/60fps) Third Stream: 1080P(1~25/30fps)
BIT RATE CONTROL	CBR/VBR
BIT RATE	H.264: 24~9472Kbps H.265: 14~5632Kbps
NETWORK	
ETHERNET	RJ-45 (10/100Base-T)
SUPPORTED WEB BROWSERS	Internet Explorer (11.0+)
SUPPORTED OS	Windows® 7 32-bit/64-bit; Windows® 10 32-bit/64-bit

NETWORK (CONT'D)	
PROTOCOLS*	HTTP; HTTPS; TCP; ARP; RTSP; RTP; RTCP; UDP; SMTP; DHCP; DNS; PPPoE; IPv4/v6; QoS; UPnP; NTP; Bonjour; IEEE 802.1x; Multicast; ICMP; IGMP; TLS
INTEROPERABILITY	ONVIF Profile S/G/Q
MAXIMUM USERS ACCESS	20 Users
SECURITY	User account and password protection HTTPS, IP Filter, Digest authentication, User access log, TLS1.2 only, AES- 128/256, SSH/Telnet closed, sFTP by default, PCIDSS compliance
EVENT	No SD card, SD card error, Capacity warning, Network disconnection, IP conflict, Illegal access
MICRO SD	Up to 128 GB microSDHC card, Class 10 (not included)
AUDIO	
COMPRESSION	G.711a /G.711Mu /AAC /G.726
INTERFACE	Built-in Mic
ELECTRICAL	
POWER SUPPLY	DC12V, PoE (802.3af)(Class 0)
POWER CONSUMPTION	<4.5W
MECHANICAL	
DIMENSIONS	Ø106mm×50.3mm (4.17"×1.98")
PRODUCT WEIGHT	0.32kg (0.71lb)
PACKAGE WEIGHT	0.46kg (1.01lb)
CONSTRUCTION	Die-cast aluminum housing with powder coat
CONSTRUCTION COLOR	RAL 9003 (White)
ENVIRONMENTAL	
OPERATING TEMPERATURE	-30° C ~ +60° C (-22° F ~ +140° F)
RELATIVE HUMIDITY	Less than 95%, non-condensing
INGRESS PROTECTION	IP66
IMPACT RESISTANCE	IK10
REGULATORY	
EMISSIONS	FCC Part 15B, EN55032
IMMUNITY	EN 50130-4
SAFETY	UL 60950-1, EN 62368-1
ROHS	EN 50581

* Some development may be required in specific user cases to support some of these protocols in the field as they mature over time.

Network WDR 2MP People Counting Camera

RECOMMENDED ACCESSORIES

SYSTEM COMPATIBILITY		MOUNTS AND ACCESSORIES	
HEN*4	8/16/32/64-channel Performance Series 4K NVRs (H.264 and H.265)	HQA-PM2**	 Pole Mount Adapter
HEN*3	4/8/16/32-channel Performance Series 4K NVRs (H.264 and H.265)	HQA-PK**	 Pendant Mount Cap
MOUNTS AND ACCESSORIES		HQA-CBE**	 Ceiling Mount Extend Bracket for HQA-CB
HQA-WK2	 Outdoor Wall Mount Bracket	HQA-CB**	 Ceiling Mount Bracket for Pendant Mount Cap
HQA-BB3**	 Junction Box		

** The HQA-BB3 must be used when installing the camera to HQA-PM2, vice versa.

The HQA-PK must be used when installing the camera to HQA-CB.

The HQA-CBE must be used with HQA-CB together.

ORDERING

H2W2PC1M	Network WDR 2MP People Counting Camera, 1/2.8" CMOS, 2.1mm Fixed, PoE, IP66, H.265/H.264/Smart Codec, support mobile
----------	--

DIMENSIONS

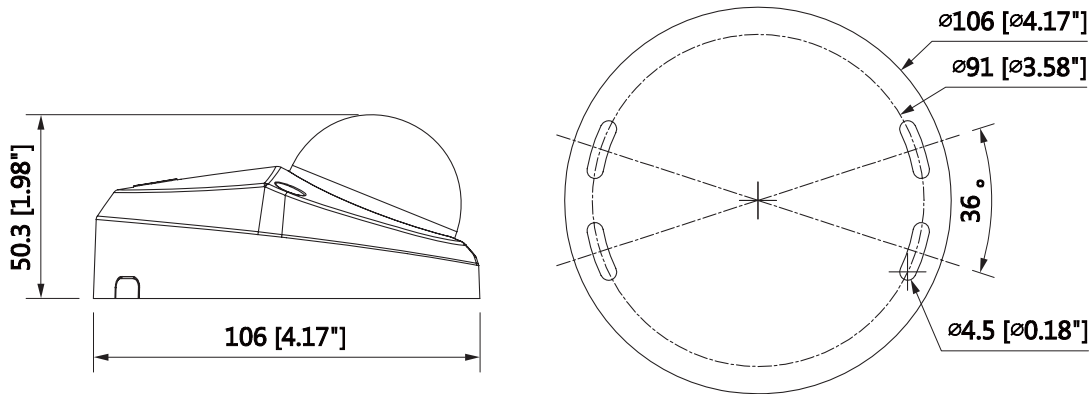

For more information

www.honeywellvideo.com

Honeywell Security Office
 Emaar Business Park, Sheikh Zayed
 Road Building No. 2, 2nd Floor, 201
 Post Office Box 232362
 Dubai, United Arab Emirates
 Tel: +971 44541704
www.honeywell.com

ONVIF and the ONVIF logo are trademarks of ONVIF Inc. Honeywell reserves the right, without notification, to make changes in product design or specifications.

HSV-H2W2PC1M-01-US(1118)DS-Y
 © 2018 Honeywell International Inc.

