

70 SERIES CAMERAS MOUNTS AND ACCESSORIES

Honeywell's 70 Series mounts and accessories provide a wide range of installation options for the Honeywell 70 Series IP cameras, including junction boxes and a variety of brackets for in-ceiling, wall, pole, and corner mounting; as well as smoked bubble replacement options.

All of the mounts and accessories offer excellent value at an attractive price with simple, clean lines, rugged construction and options suitable for indoor or outdoor mounting use.

The mounts provide easy cable routing with no exposed wiring, and the cameras can be installed, adjusted, and tested without repositioning the housing.

With the help of a Wi-Fi dongle, cable adaptor and a downloadable app, dome and bullet cameras can be wirelessly configured from mobile phones, tablets and laptops. This setup translates into easier installations, and commissioning becomes a single person process, while reducing time & labor cost.



HA60BB1
Junction Box



HA60PLMZ
Pole Mount
Bracket

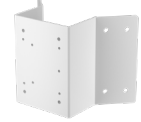

HA60CNMZ
Corner Mount
Bracket



HA60WIF
Wifi Dongle



HA60PMC4
Pendant Mount
Adapter
(Rev C or above)



HA60WLM4
Wall Mount
Bracket
(Rev C or above)



HA70RPG
Dome Camera
Rubber Kit



HA70SB4
Dome Camera
Smoked Bubble





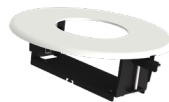











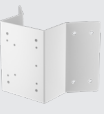

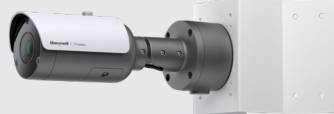
HA70SB5
In-ceiling PTZ Camera
Smoked Bubble



HA70ICK
In-ceiling Mount
Bracket

MOUNTS AND ACCESSORIES

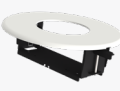
COMPATIBLE 70 SERIES CAMERAS

MODEL	HC70W48R2	HC70WB8R2	HC70WZ5130
HA60BB1 			
HA60PLMZ 	+HA60WLM4 	+HA60BB1 	
HA60CNMZ 	+HA60WLM4 	+HA60BB1 	
HA60WLM4* 			
HA60PMC4* 	+Pendant mount bracket (bracket and installation not included) 		
HA60WIF 	✓	✓	
HA70RPG 	✓		
HA70SB4 	✓		
HA70SB5 			✓
HA70ICK 			

* Rev C or above

MOUNTS AND ACCESSORIES

SPECIFICATIONS

MODEL	INDOOR/ OUTDOOR	CONSTRUCTION	COLOR	WEIGHT	DIMENSIONS
HA60BB1	Indoor/outdoor	ADC12	RAL 7022 (Dark Gray)	0.4 kg (0.8 lb)	Ø 105.0 x 56.0 mm (Ø 4.1 x 2.2 in.)
HA60PLMZ	Indoor/outdoor	Steel	RAL 9003 (Signal White)	1.3 kg (2.8 lb)	170.0 x 134.5 x 48.2 mm (6.7 x 5.3 x 1.9 in.)
HA60CNMZ	Indoor/outdoor	Steel	RAL 9003 (Signal White)	3.1 kg (6.9 lb)	243.2 x 170.0 x 138.7 mm (9.6 x 6.7 x 5.5 in.)
HA60WLM4*	Indoor/outdoor	ADC12	RAL 9003 (Signal White)	0.9 kg (2.0 lb)	Ø 164.7 x 276.8 x 139.3 mm (Ø 6.5 x 10.9 x 5.5 in.)
HA60PMC4*	Indoor/outdoor	ADC12	RAL 9003 (Signal White)	0.4 kg (0.9 lb)	Ø 164.7 x 46.2 mm (Ø 6.5 x 1.8 in.)
HA70ICK	Indoor	Bracket: Steel Cover: Plastic		0.88 lb (0.4 kg)	215.9 x 63 x 67.9 mm (8.5 x 2.5 x 2.7 in.)

* Rev C or above

DIMENSIONS

HA70ICK

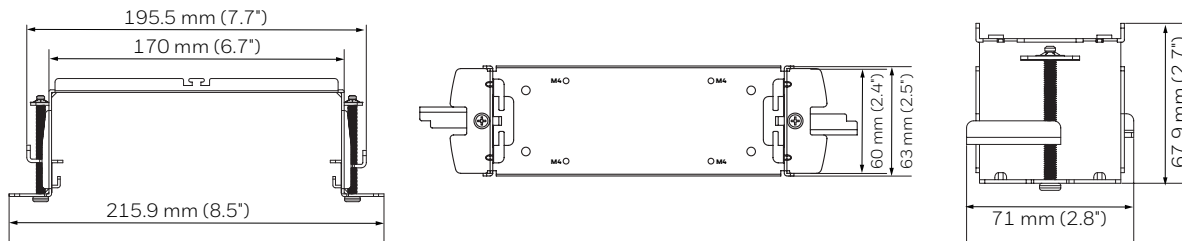

HA60BB1

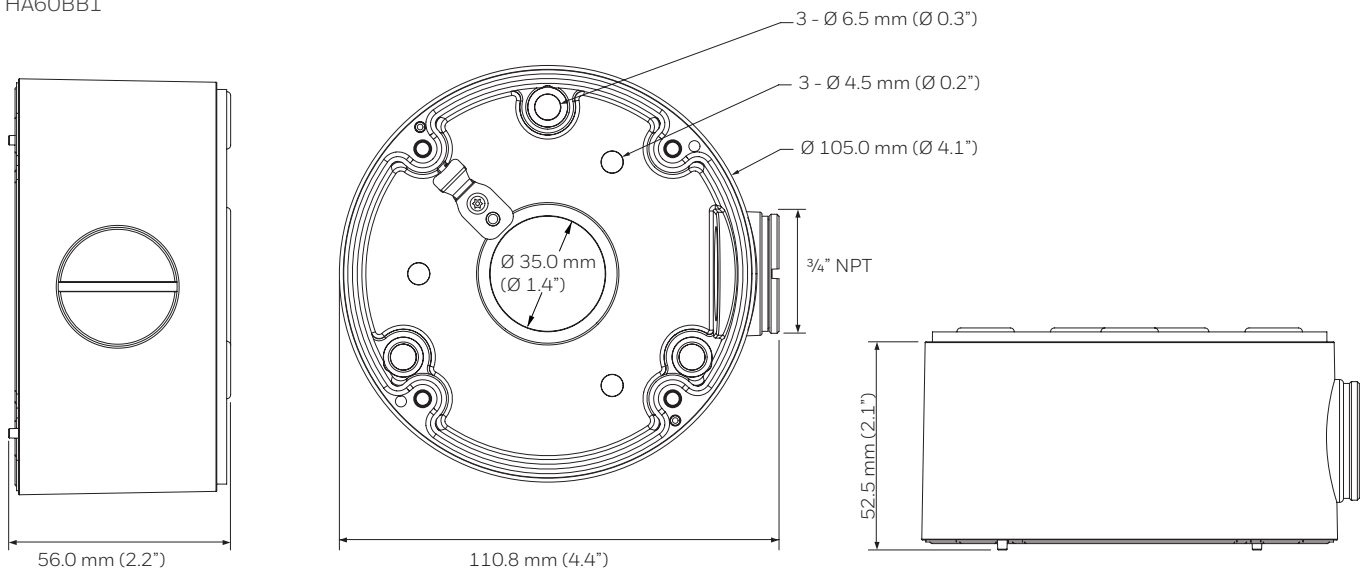

MOUNTS AND ACCESSORIES

DIMENSIONS

HA60PLMZ

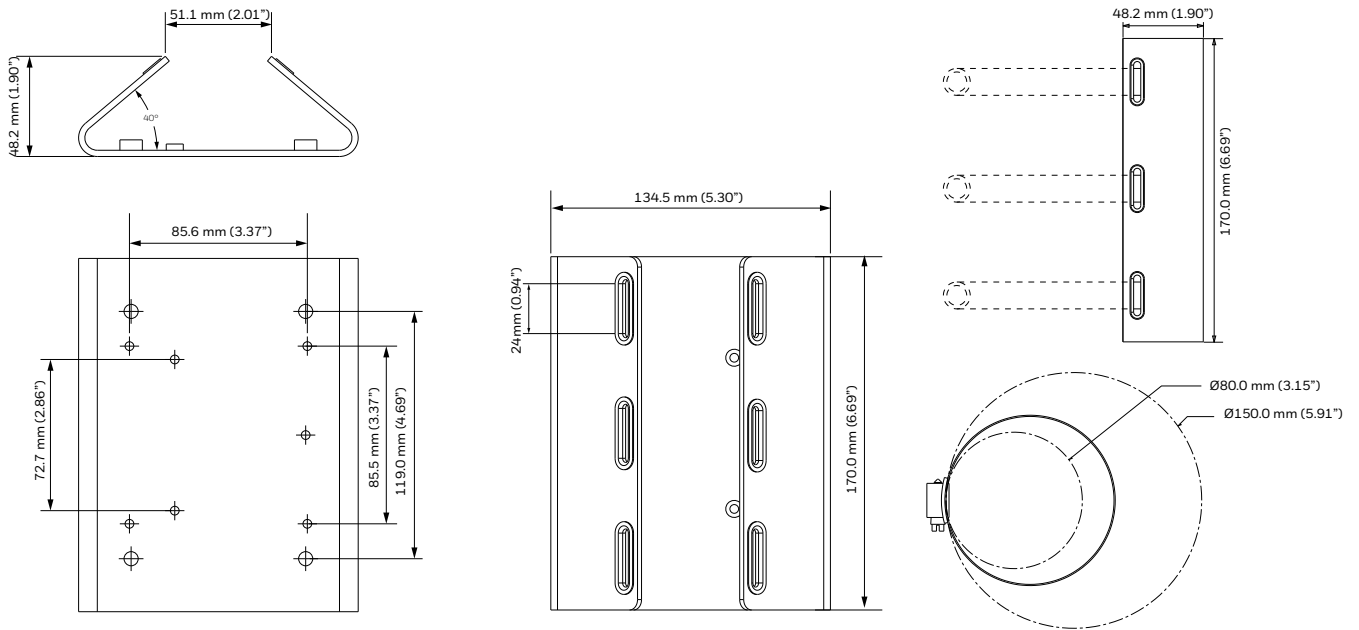

HA60CNMZ

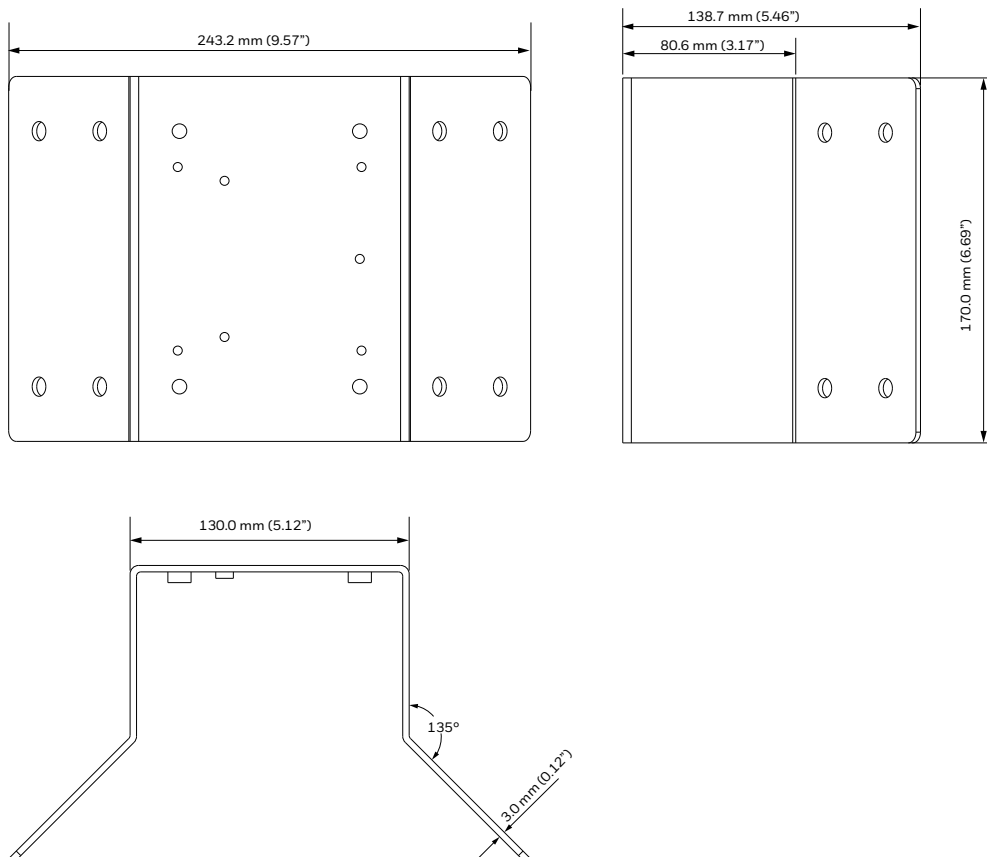

MOUNTS AND ACCESSORIES

DIMENSIONS

HA60WLM4 (Rev C or above)

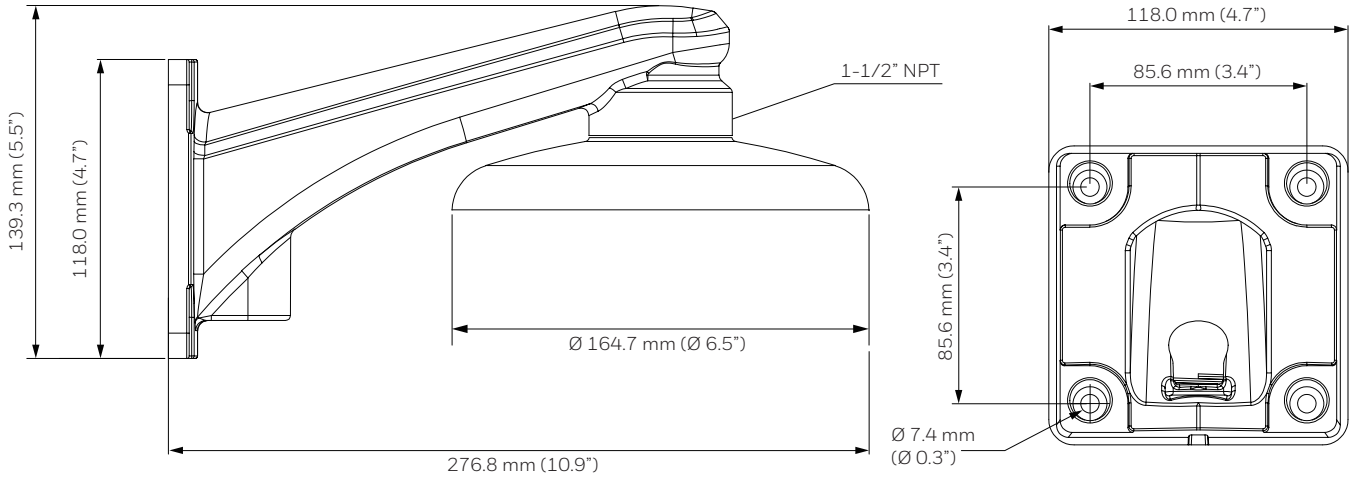

HA60PMC4 (Rev C or above)

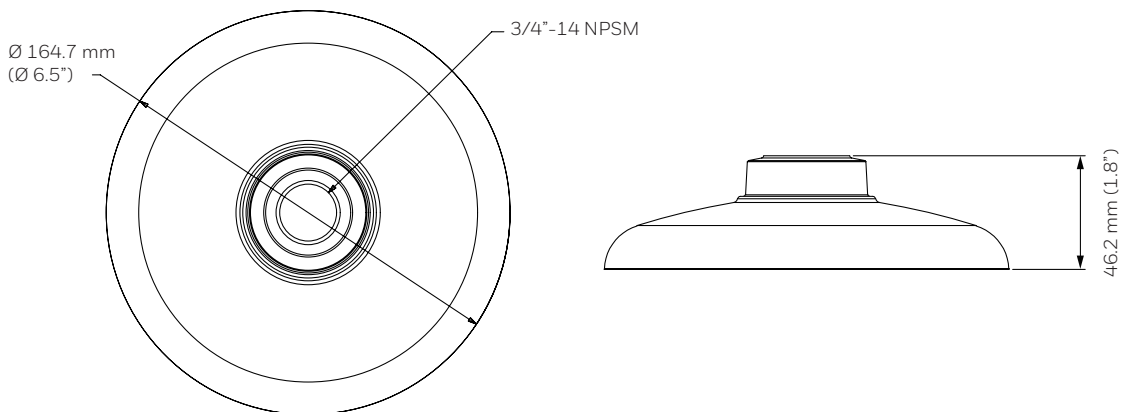

MOUNTS AND ACCESSORIES

ORDERING

MODEL	DESCRIPTION	MODEL	DESCRIPTION
HA60BB1*	Junction box, 60 and 70 series outdoor bullet camera	HA60WIF*	Wifi dongle and USB adapter for camera configuration
HA60PLMZ*	PTZ pole mount bracket, white	HA70RPG	70s dome camera rubber kit
HA60CNMZ*	PTZ corner mount bracket, white	HA70SB4	70s dome camera smoked bubble
HA60WLM4*	Wall mount bracket for 4 inch dome, white	HA70SB5	70s In-ceiling PTZ camera smoked bubble
HA60PMC4*	Pendant mount adapter, 1.5NPT(outside), 3/4NPT (inside)	HA70ICK	70s dome camera in-ceiling mount bracket

* Accessories beginning with HA60 listed here will work with select models of both 60 Series and 70 Series cameras. Consult datasheet and compatibility matrix for more information.

For HA60WLM4 and HA60PMC4, please use Rev C or above.

For more information

www.security.honeywell.com/uk
www.security.honeywell.com/me
buildings.honeywell.com

Honeywell Commercial Security

Emaar Business Park, Sheikh Zayed Road
 Building No. 2, 2nd floor, 201
 Post Office Box 232362
 Dubai, United Arab Emirates
 Tel: +971 4 450 5800

Building 5 Carlton Park
 King Edward Avenue
 Narborough, Leicester LE19 0AL
 United Kingdom

Tel: +44 (0) 1163 500714

www.honeywell.com

Honeywell reserves the right, without notification, to make changes in product design or specifications.

HSV-70_MNTS_ACC-01-UK(0323)DS-Y
 © 2023 Honeywell International Inc.

