

# 70 SERIES CAMERAS MOUNTS AND ACCESSORIES

Honeywell's 70 Series mounts and accessories provide a wide range of installation options for the Honeywell 70 Series IP cameras, including junction boxes and a variety of brackets for in-ceiling, wall, pole, and corner mounting; as well as smoked bubble replacement options.

All of the mounts and accessories offer excellent value at an attractive price with simple, clean lines, rugged construction and options suitable for indoor or outdoor mounting use.

The mounts provide easy cable routing with no exposed wiring, and the cameras can be installed, adjusted, and tested without repositioning the housing.

With the help of a Wi-Fi dongle, cable adaptor and a downloadable app, dome and bullet cameras can be wirelessly configured from mobile phones, tablets and laptops. This setup translates into easier installations, and commissioning becomes a single person process, while reducing time & labor cost.



HA60BB1  
Junction Box



HA60PLMZ  
Pole Mount  
Bracket



HA60CNMZ  
Corner Mount  
Bracket



HA60WIF  
Wifi Dongle



HA60PMC4  
Pendant Mount  
Adapter  
(Rev C or above)



HA60WLM4  
Wall Mount  
Bracket  
(Rev C or above)



HA70RPG  
Dome Camera  
Rubber Kit



HA70SB4  
Dome Camera  
Smoked Bubble





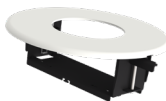











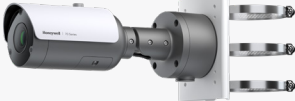

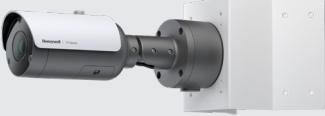
HA70SB5  
In-ceiling PTZ Camera  
Smoked Bubble



HA70ICK  
In-ceiling Mount  
Bracket

# MOUNTS AND ACCESSORIES

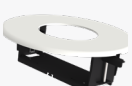
## COMPATIBLE 70 SERIES CAMERAS

MODEL	HC70W48R2	HC70WB8R2	HC70WZ5I30
HA60BB1 			
HA60PLMZ 	+HA60WLM4 	+HA60BB1 	
HA60CNMZ 	+HA60WLM4 	+HA60BB1 	
HA60WLM4* 			
HA60PMC4* 	+Pendant mount bracket (bracket and installation not included) 		
HA60WIF 	✓	✓	
HA70RPG 	✓		
HA70SB4 	✓		
HA70SB5 			✓
HA70ICK 			

\* Rev C or above

# MOUNTS AND ACCESSORIES

## SPECIFICATIONS

MODEL	INDOOR/ OUTDOOR	CONSTRUCTION	COLOR	WEIGHT	DIMENSIONS
HA60BB1	Indoor/outdoor	ADC12	RAL 7022 (Dark Gray)	0.4 kg (0.8 lb)	Ø 105.0 x 56.0 mm (Ø 4.1 x 2.2 in.)
HA60PLMZ	Indoor/outdoor	Steel	RAL 9003 (Signal White)	1.3 kg (2.8 lb)	170.0 x 134.5 x 48.2 mm (6.7 x 5.3 x 1.9 in.)
HA60CNMZ	Indoor/outdoor	Steel	RAL 9003 (Signal White)	3.1 kg (6.9 lb)	243.2 x 170.0 x 138.7 mm (9.6 x 6.7 x 5.5 in.)
HA60WLM4*	Indoor/outdoor	ADC12	RAL 9003 (Signal White)	0.9 kg (2.0 lb)	Ø 164.7 x 276.8 x 139.3 mm (Ø 6.5 x 10.9 x 5.5 in.)
HA60PMC4*	Indoor/outdoor	ADC12	RAL 9003 (Signal White)	0.4 kg (0.9 lb)	Ø 164.7 x 46.2 mm (Ø 6.5 x 1.8 in.)
HA70ICK	Indoor	Bracket: Steel Cover: Plastic		0.88 lb (0.4 kg)	215.9 x 63 x 67.9 mm (8.5 x 2.5 x 2.7 in.)

\* Rev C or above

## DIMENSIONS

HA70ICK

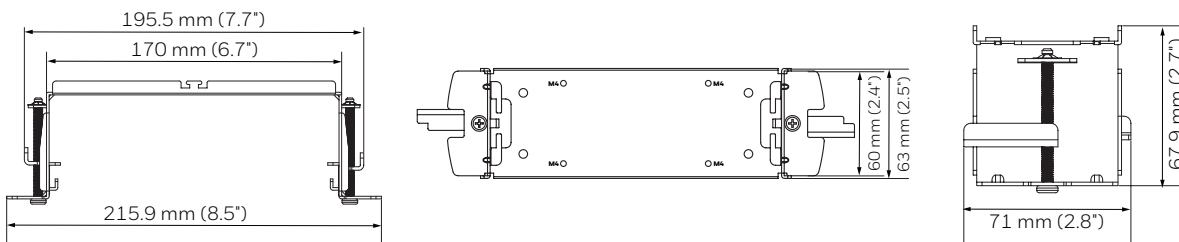

HA60BB1

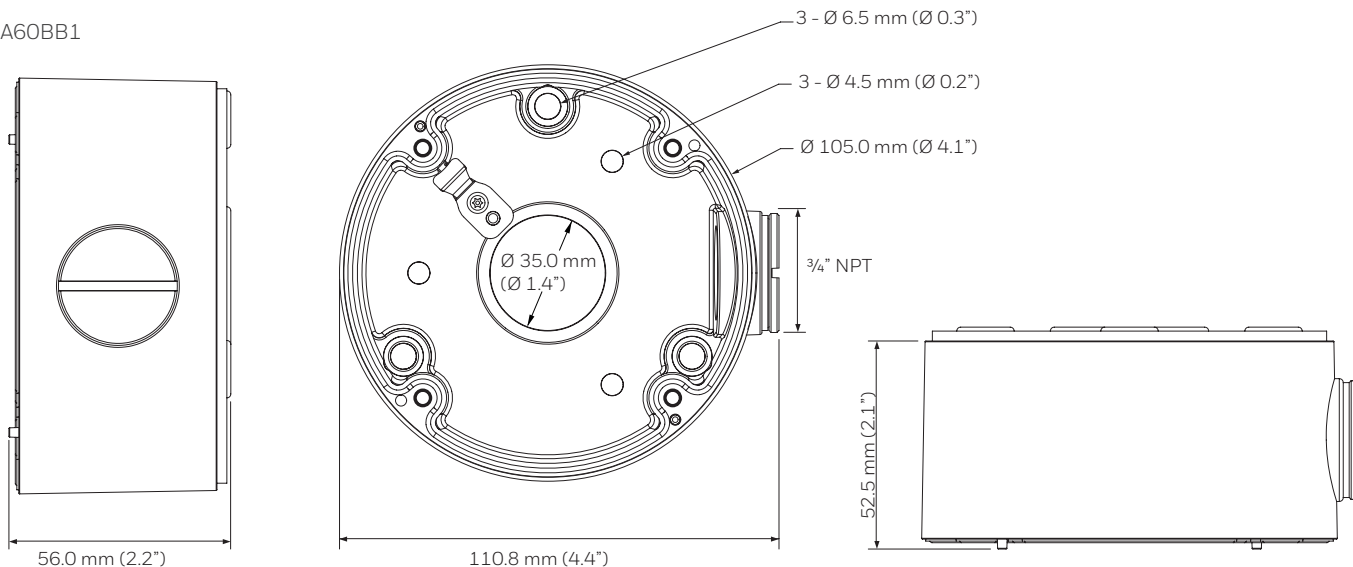

# MOUNTS AND ACCESSORIES

## DIMENSIONS

HA60PLMZ

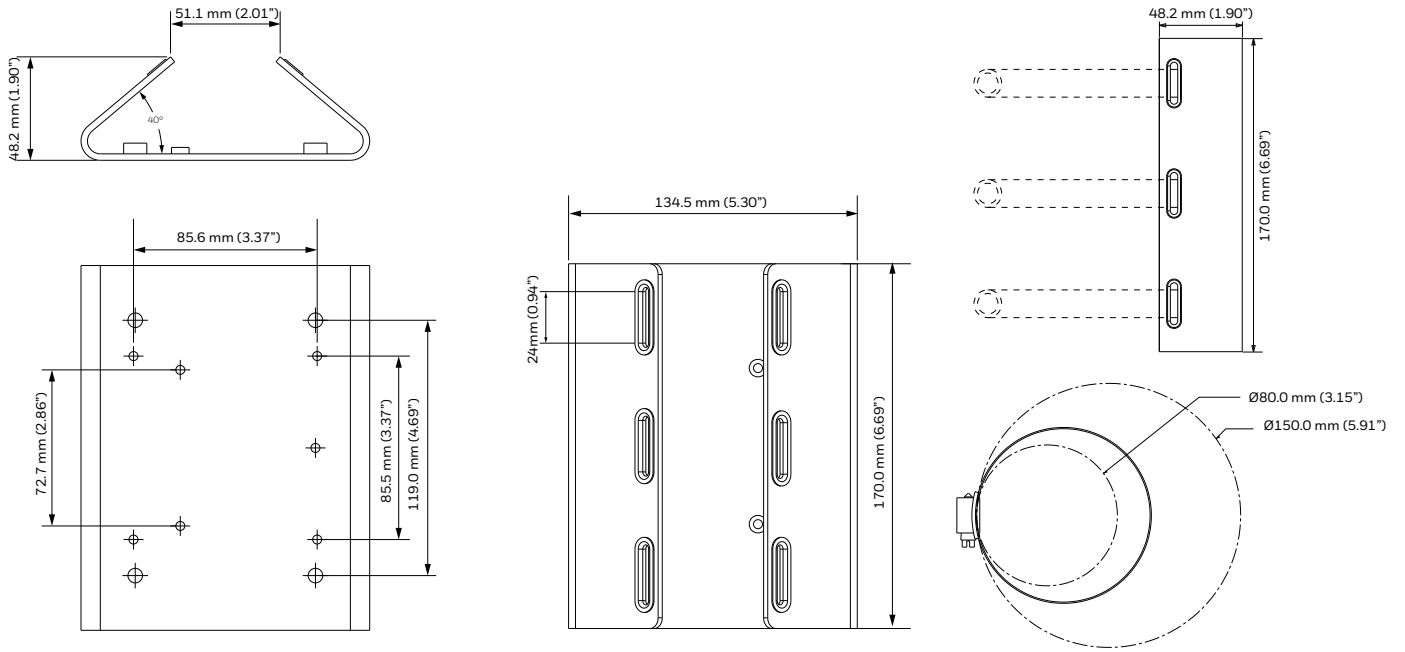

HA60CNMZ

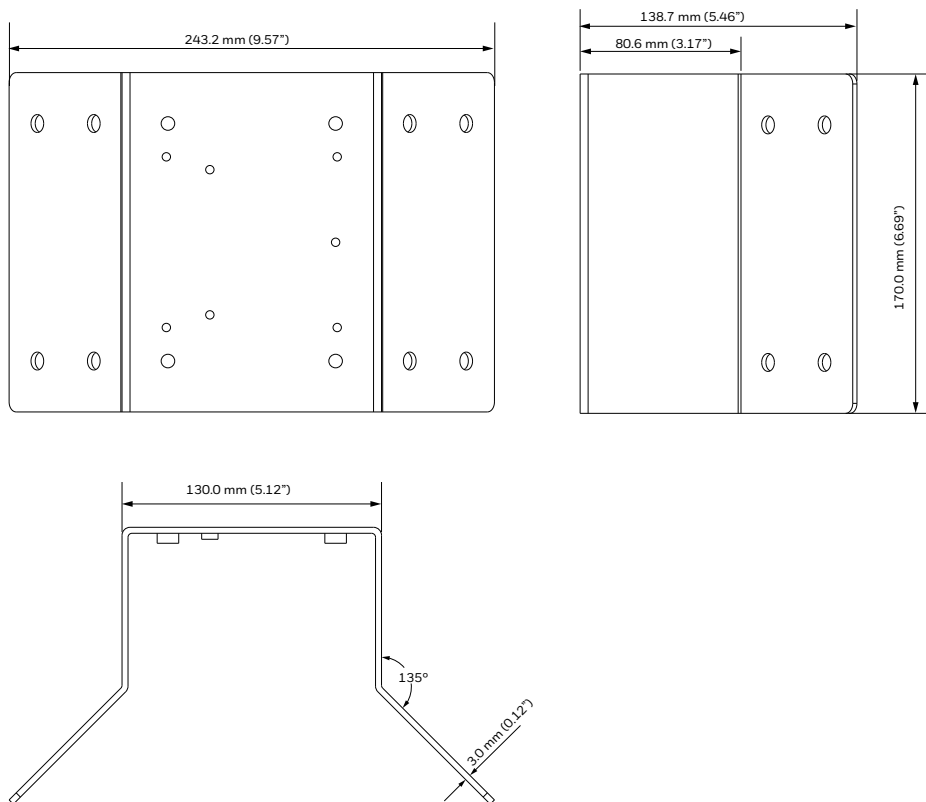

# MOUNTS AND ACCESSORIES

## DIMENSIONS

HA60WLM4 (Rev C or above)

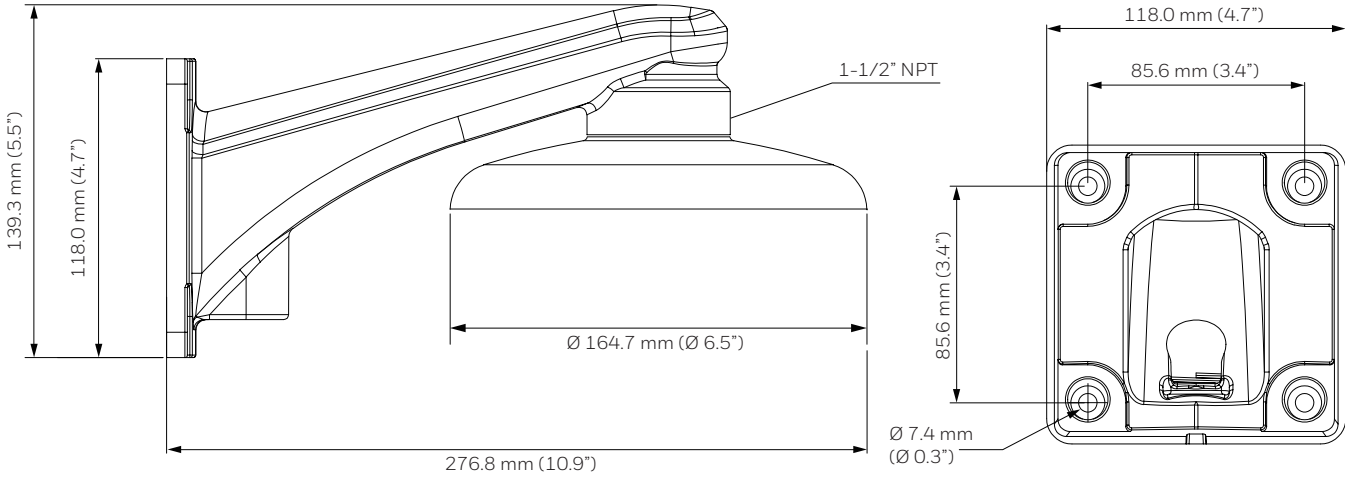

HA60PMC4 (Rev C or above)

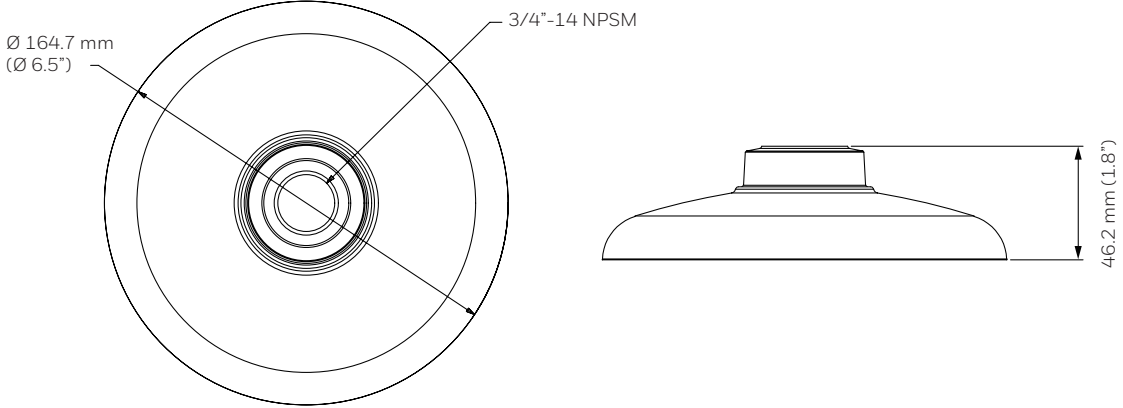

# MOUNTS AND ACCESSORIES

## ORDERING

MODEL	DESCRIPTION	MODEL	DESCRIPTION
HA60BB1*	Junction box, 60 and 70 series outdoor bullet camera	HA60WIF*	Wifi dongle and USB adapter for camera configuration
HA60PLMZ*	PTZ pole mount bracket, white	HA70RPG	70s dome camera rubber kit
HA60CNMZ*	PTZ corner mount bracket, white	HA70SB4	70s dome camera smoked bubble
HA60WLM4*	Wall mount bracket for 4 inch dome, white	HA70SB5	70s In-ceiling PTZ camera smoked bubble
HA60PMC4*	Pendant mount adapter, 1.5NPT(outside), 3/4NPT (inside)	HA70ICK	70s dome camera in-ceiling mount bracket

\* Accessories beginning with HA60 listed here will work with select models of both 60 Series and 70 Series cameras. Consult datasheet and compatibility matrix for more information.

For HA60WLM4 and HA60PMC4, please use Rev C or above.

### For more information

[buildings.honeywell.com/security](https://buildings.honeywell.com/security)

### Honeywell Commercial Security

715 Peachtree St. NE

Atlanta, GA 30308

1.800.323.4576

[www.honeywell.com](https://www.honeywell.com)

Honeywell reserves the right, without notification, to make changes in product design or specifications.

HSV-70\_MNTS\_ACC-01-US(0323)DS-Y  
© 2023 Honeywell International Inc.

