

PERFORMANCE SERIES

HEW2PER2V



Network WDR 2MP IR Varifocal Eyeball Camera



OPERATIONAL	
Video Standard	NTSC / PAL
Scanning System	Progressive
Image Sensor	1 / 2.8" 2 Megapixel progressive CMOS
Number Of Pixels(H x V)	1920 x 1080
Minimum Illumination	0.002 Lux / F1.5(color,30IRE), 0 Lux with (IR ON)
S/N Ratio	More than 45 dB
Electronic Shutter Speed	1 / 3~1 / 100000s
IR Distance	Up to 40m (131.23 ft), depending on scene reflectance
IR Light Control	Manual / Smart IR / OFF
IR Light Number	2
Day/Night	Auto(ICR) / Color / B&W
Backlight Compensation	BLC / HLC / WDR
Wide Dynamic Range	120 dB
White Balance	Auto / Natural / Street Lamp / Outdoor / Manual / Customized Region
Gain Control	0~100
Noise Reduction	3D DNR
Privacy Masking	Off / On (4 Areas, Rectangle)
Motion Detection	Off / On (4 Zones, Rectangle)
Region Of Interest	Off / On (4 Zones)
Lens	2.7 mm~13.5 mm, Motorized, F1.5
ANGLE OF VIEW	H: 109°~28°, V: 57°~16°
VIDEO	
Compression	H.265 / H.264 / Smart Codec / MJPEG (Sub Stream)
Resolution	1080p (1920 x 1080); 1.3M (1280 x 960); 720p (1280 x 720); D1 (704 x 576 / 704 x 480); VGA (640 x 480); CIF (352 x 288 / 352 x 240)
Frame Rate	Main Stream: 1920 x 1080 / 1280 x 960 / 1280 x 720@ (1 ~ 25 / 30 fps) Sub Stream: 704 x 576 / 640 x 480 / 352 x 288@ (1 ~ 25 fps); 704 x 480 / 640 x 480 / 352 x 240@ (1 ~ 30 fps)
Bit Rate Control	CBR / VBR
Bit Rate	H.264: 32 Kbps – 6144 Kbps H.265: 12 Kbps – 6144 Kbps
Analytics	Motion Detection, Video Tampering, Scene Changing, Tripwire Intrusion

NETWORK	
Ethernet	RJ-45 (10 / 100 Base-T)
Supported Web Browsers	Internet Explorer (11.0+)
Supported OS	Windows® 7 32-bit / 64-bit; Windows® 10 32-bit / 64-bit
Protocols*	HTTP; HTTPS; TCP; ARP; RTSP; RTP; RTCP; UDP; SMTP; DHCP; DNS; PPPoE; IPv4/v6; QoS; UPnP; NTP; Bonjour; IEEE 802.1x; Multicast; ICMP; IGMP; TLS
Compatibility	ONVIF Profile S / G / Q / T
Maximum Users Access	20 users
Security	User account and password protection HTTPS, IP Filter, Digest authentication, User access log, TLS1.2 only, AES-128 / 256, SSH / Telnet closed, sFTP by default, PCIDSS compliance
Event	No SD card, SD card error, Capacity warning, Network disconnection, IP conflict, Illegal access
Micro SD	Supports max. 256 GB Micro SD card
ELECTRICAL	
Power Supply	DC12V PoE (802.3 af)(Class 0)
Power Consumption	<6.4W
MECHANICAL	
Dimensions	Ø108.3 mm x 122 mm (4.26" x 4.80")
Product Weight	0.69 kg (1.52 lb)
Package Weight	0.88 kg (1.94 lb)
Construction	Die-cast aluminum housing with powder coat
Construction Color	RAL 9003 (White)
ENVIRONMENTAL	
Operating Temperature	-30°C to 60°C (-22°F to 140°F)
Relative Humidity	Less than 95%, non-condensing
Ingress Protection	IP66
REGULATORY	
Emissions	FCC Part 15B, EN55032
Immunity	EN 50130-4
Safety	UL 60950-1, EN 62368-1
RoHS	EN 50581







* Some development may be required in specific user cases to support some of these protocols in the field as they mature over time.

PERFORMANCE SERIES NETWORK WDR 2MP IR VARIFOCAL EYEBALL CAMERA

RECOMMENDED ACCESSORIES

SYSTEM INTEGRATION	
HEN*4	8 / 16 / 32 / 64-Channel Performance Series 4K NVRs (H.264 and H.265)
HEN*3	4 / 8 / 16 / 32-Channel Performance Series 4K NVRs (H.264 and H.265)
HEN*3V	4 / 8 / 16- Channel Embedded NVRs (H.265)

MOUNTS AND ACCESSORIES		
HQA-WK**		Wall Mount
HQA-BB4		Junction Box
HQA-BB2**		Junction Box

MOUNTS AND ACCESSORIES		
HEJB		Back box
HQA-PM2		Pole Mount Adapter
HQA-PK		Pendant Mount Cap
HQA-CBE**		Ceiling Mount Extend Bracket
HQA-CB**		Ceiling Mount Bracket
HB34S2-CM		Corner Mount Adapter
HBS2-BB		Back Box

**The HQA-WK/HQA-BB2 must be used when installing the camera to HQA-PM2.

The HQA-CB must be used when installing the camera to HQA-PK.

The HQA-CBE must be used with HQA-CB together.

The HQA-BB2 / HBS2-BB must be used when installing the camera to HB34S2-CM.

ORDERING	
HEW2PER2V	Network WDR 2MP IR Eyeball Camera, 1 / 2.8" CMOS, 2.7 mm~13.5 mm Motorized, 2 IR LEDs, PoE, IP66, H.265 / Smart Codec

DIMENSIONS

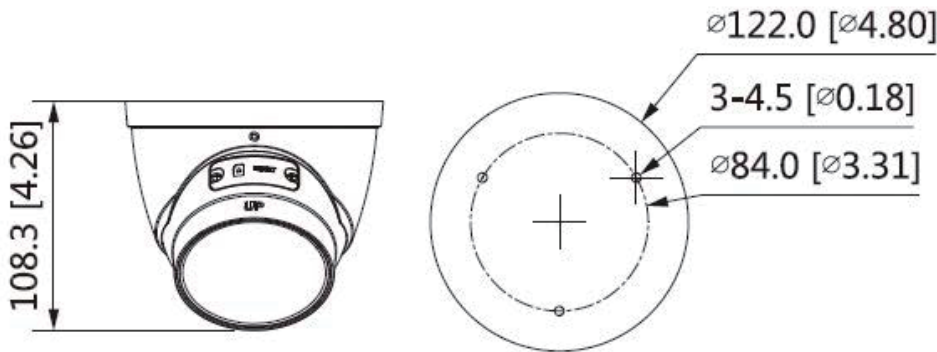

For more information

buildings.honeywell.com/security

Honeywell Commercial Security

715 Peachtree St. NE

Atlanta, GA 30308

1.800.323.4576

www.honeywell.com

ONVIF and the ONVIF logo are trademarks of ONVIF Inc. Honeywell reserves the right, without notification, to make changes in product design or specifications.

HSV-HEW2PER2V-01-US(0921)DS-Y
© 2021 Honeywell International Inc.

Honeywell