

1080p 30x Zoom Corrosion Proof IP Camera

HCPB302

Designed for use in highly corrosive environments, Honeywell's new HCPB302 network camera features an AISI 316L stainless steel housing to provide maximum protection against deterioration. The camera provides extremely crisp video with up to 2 million effective pixels, 30x optical zoom, True Day/Night, and True WDR for continuous surveillance.



Rugged Design

- Housing made of AISI 316L stainless steel
- Nickel-plated brass cable glands for external connections
- IP66/IP68 weatherproof rating
- Operating temperature range: -40°C to 60°C
- Optional wiper kit and washer system

Superior Image Quality

- 1080p 50/60 fps image with 1/2.8" progressive CMOS
- Wide Dynamic Range, up to 120 dB, for glare-free images
- True Day/Night for vivid color images by day and clear black-and-white images at night
- Excellent low-light performance with 3D noise reduction, saving storage and bandwidth

Flexible Surveillance Solution

- 4.5–135 mm motorized focus/zoom lens with 30x optical zoom to clearly view target area with desired depth
- H.265/H.264/MJPEG codec, triple stream support
- Support for unicast and multicast streaming
- Support for face detection, intrusion tracing
- Security features include signed certificates and data encryption

Easy to Install and Use

- 24 VAC power input
- Wall, corner, and pole mount options
- Remote configuration, motorized zoom adjustments, and autofocus through web client

Market Opportunities

These cameras are ideally suited for industrial chemical, petrochemical, marine, naval, and offshore platforms.

FEATURES AND BENEFITS

- 1/2.8" progressive scan imager
- 4.5–135 mm, F1.6–F1.4, 30x optical zoom lens
- True day/night (IR-cut filter)
- True WDR up to 120 dB
- Ultra low-light performance down to 0.0005 lux B/W
- Multiple, selectable compression formats (H.265/H.264/MJPEG)
- Triple stream support
- Up to 50/60 fps primary stream; up to 25/30 fps secondary stream
- Built-in analytics including face detection and intrusion tracing
- Global language support for Web GUI and online help
- 24 VAC power input
- ONVIF Profile S
- IP66/IP68 weatherproof rating
- -40°C to 60°C operating temperature
- Built-in cybersecurity hardware chipset

Corrosion-Proof IP Camera

FEATURES

Security Features

The camera can be configured to automatically detect and respond to events such as motion in the scene and/or camera tampering. Automated responses include sending a notification through email, FTP, and/or HTTP, and sending a still image of the event through email and/or FTP. Setup can be done through a web client.

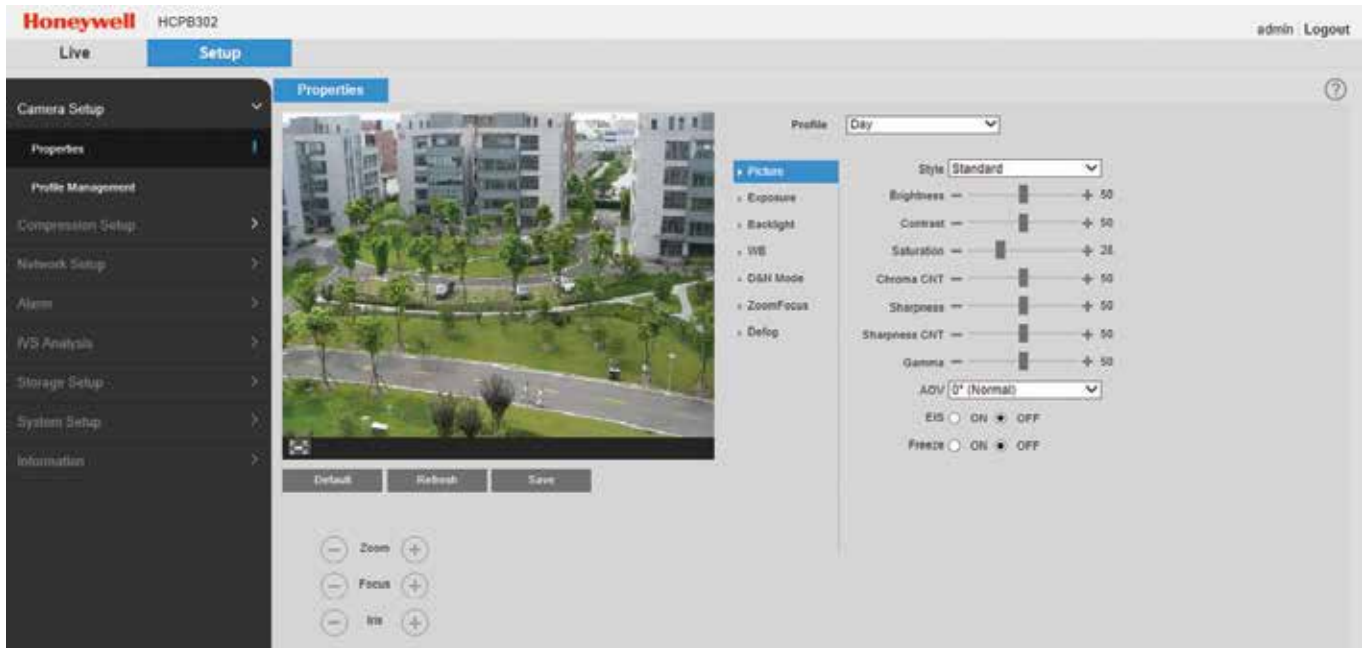

DIMENSION

HCPB302

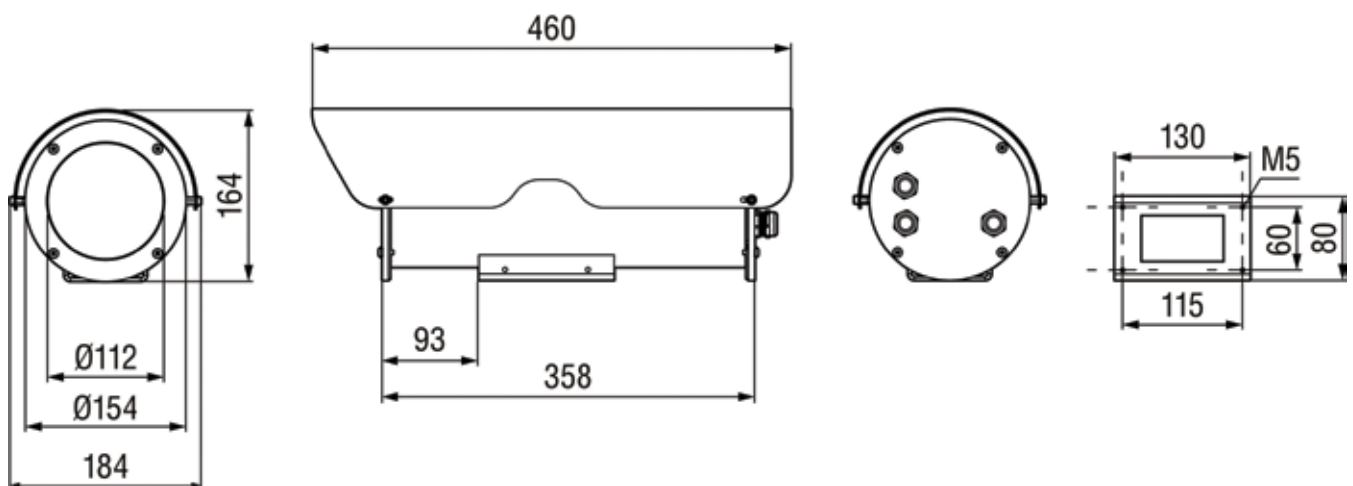

Corrosion-Proof IP Camera

SPECIFICATIONS

CAMERA	
Image Sensor	1/2.8* Sony Progressive CMOS
Optical Zoom	30x
Digital Zoom	16x
Number of Pixels	1920 (H) × 1080 (V)
Shutter WDR	120 dB
S/N RATIO	55 dB or more (AGC off)
Minimum Illumination	0.005 lux (color), 0.0005 lux (B/W) @ F1.6
Lens	4.5–135 mm, F1.6–F4.4
Angle of View	H: 62.35°–2.53° V: 37.87°–1.79°
Electronic Shutter Speed	1/1–1/30 000 s
Day/Night	Auto/Color/BW
Backlight Compensation	BLC/HLC/WDR (120 dB)
White Balance	Auto/Indoor/Outdoor/ATW/Manual
Noise Reduction	3DNR
Electronic Image Stabilization	On/Off
Defog	On/Off
OPERATION	
Privacy Masks	24
Motion Detection	On/Off
Video Analytics	Intrusion trace*; face detection
Event	Intrusion; face detection; motion detect; video tamper; IP address conflict; illegal access
Event Notification	Record to FTP, relay output, email, snapshot
IP SPECIFICATIONS	
Video Compression	H.265/H.264/MJPEG
Video Streaming	Primary Stream: 1080p @ 50/60 fps; 1.3 MP/720p @ 25/30 fps Second Stream: 1080p/1.3 MP/720p @ 25/30 fps Third Stream: D1/CIF @ 25/30 fps
Video Resolution	Up to 1920 × 1080 pixels
Interface	RJ45, 10/100 Mbps Ethernet
Supported Protocols**	IPv4/v6, TCP/IP, UDP, RTP, RTSP, HTTP, HTTPS, SSL, ICMP, FTP, SMTP, DHCP, PPPoE, UPnP, IGMP, SNMP, Bonjour, DNS, DDNS, IEEE 802.1x, QoS, NTP, IP Filter, ONVIF, RS485, Pelco P, Pelco D
Security	Multiple user access levels with enhanced password policy, IP filtering, IEEE 802.1X, strong digest authentication for access permission, HTTPS, TLS1.2 only, high-strength encrypted algorithm AES-256, SSH/Telnet closed, FTP disabled to reduce surface being attacked, PCI-DSS compliant, built-in cybersecurity hardware chipset

IP SPECIFICATIONS (CON'T D)	
Maximum Users	20 users
Supported Languages (Web Client/Help)	English, Arabic, Czech, Dutch, French, German, Italian, Japanese, Korean, Polish, Portuguese, Russian, Simplified Chinese, Spanish, Turkish
Web Browsers	Internet Explorer (11.0+), Firefox, Chrome
Supported OS	Windows 7 32-bit/64-bit
Communication	ONVIF Profile S
ELECTRICAL	
Power Source	24 VAC, 2.2 A, 50/60 Hz
Power Consumption	42 W max
MECHANICAL	
Dimensions	460.0 × 184.0 × 164.0 mm
Weight	8.5 kg
Connectors	Power Input: 3-pin Digital Input and GND: 2-pin for reset Alarm Output: 1 out RS485: 2-pin, half duplex, for wiper and washer Network: RJ45, 10/100 Mbps Ethernet
Construction	AISI 316L stainless steel, tempered glass
Cable Glands	3 × PG13.5
ENVIRONMENTAL	
Operating Temp	-40°C to 60°C, cold start -20°C
Relative Humidity	10–95%, non-condensing
IP66/IP68	IP66/IP68
REGULATORY	
Emissions	EN 55032; EN 61000-6-4
Immunity	EN 50130-4
Safety	EN60950-1; EN60950-22
RoHS	EN 50581

* IntrusionTrace from Xtralis. Additional license purchase required. For more information, visit <https://xtralis.com/p.cfm?s=1001&p=785>





** Some development may be required in specific user cases to support some of these protocols in the field as they mature over time.

Corrosion-Proof IP Camera

ORDERING

System Integration	
Open IP Integration	
ONVIF support and open API software integration. Refer to www.onvif.org for the ONVIF specification and the Honeywell Open Technology Alliance website (http://www.security.honeywell.com/hota/) to learn more about our open and integrated solutions.	

Device Integration	
MAXPRO® NVR Family	Entry to Enterprise Level Network Video Recorders (version 4.10 and greater)
MAXPRO® VMS Family	Entry to Enterprise Level Network Video VMS (version R410 and greater)
DVM	DVM R600.1 SP1
HUS	HUS 5.1

Accessories		
HCPWK		AISI 316L Stainless Steel Wiper Kit, 24 VAC
HCPWSK		Washer System Kit, 24 VAC
HCPWM		AISI 316L Stainless Steel Wall Mount Bracket with Joint
HCPPMA		AISI 316L Stainless Steel Pole Mount Adapter
HCPCMA		AISI 316L Stainless Steel Corner Mount Adapter

Device Integration	
HCPB302	Corrosion-Proof IP Camera, 1/2.8" CMOS, 1080p, 30x, 4.5–135 mm MFZ, 24 VAC, H.265

NOTE: Honeywell reserves the right, without notification, to make changes in product design or specifications.

For additional information, please visit

www.honeywell.com/security/uk

Honeywell Security & Fire

Aston Fields Road
 Whitehouse Industrial Estate
 Runcorn
 Cheshire
 WA7 3DL
 United Kingdom
 Tel: +44 (0)8448 000 235
www.honeywell.com

Honeywell reserves the right, without notification, to make changes in product design or specifications.

HSFV-HCPB302-01-UK(0517)DS-E
 May 2017
 © 2017 Honeywell International Inc.

Honeywell