

PCD3.W315

Analog input module, 7 channel, 12 bit, 0 ... 20 mA,
electrically isolated from the CPU



High-speed input modules for general use with 7 channels, each with 12 bit resolution and 0 ... 20 mA. Electrically isolated from the CPU.

Technical specifications

Number of inputs (channels)	7
Signal range	0 ... 20 mA
Resolution (representation)	12 bit (0 ... 4095)
Resolution (value of least significant bit(LSB))	5 μ A
Galvanic separation	500 V, electrical isolation of outputs to CPU, channels themselves not separated
Measuring principle	non-differential, single-ended
Input resistance	120 Ω / 0.1 %
Accuracy at 25 °C	\pm 0.15 %
Repeating accuracy (under same conditions)	\pm 0.05 %
Temperature error (0 ... +55 °C)	\pm 0.25 %
Conversion time A/D	\leq 2 ms
Overcurrent protection	\pm 35 mA (permanent)
EMV protection	yes
Time constant of input filter	typisch 2.4 ms
Internal current consumption (from +5 V bus)	< 60 mA
Internal current consumption (from V+ bus)	0 mA
External current consumption	0 mA
Terminals	Pluggable 10-pole spring terminal block for \varnothing up to 2.5 mm ² , plug type E (4 405 4998 0)



PCD3.W315

Block schematic

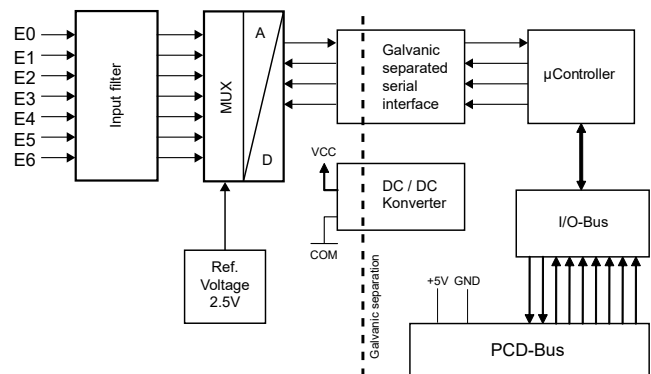

Indicators and connections

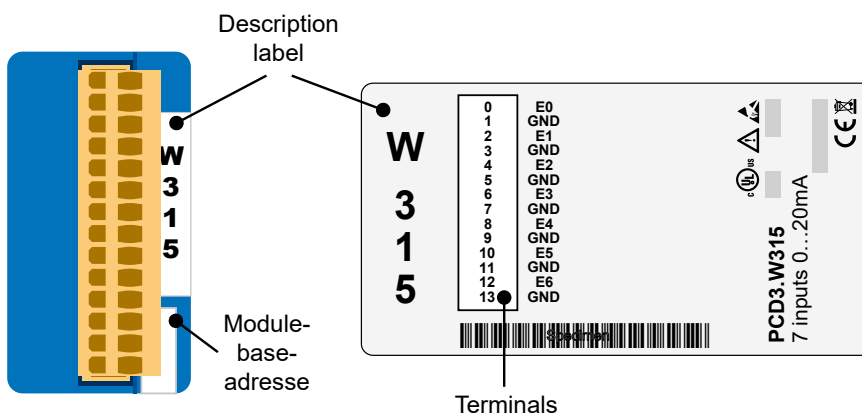

The GND connections are connected together in the module and are galvanically isolated from the CPU. These GNDs must not be connected to the CPU, process GNDs or ground !

Connection concept for voltage inputs

The voltage input signals are connected directly to the 14-pole terminal block (E0 ... E6 and GND). To minimize the amount of interference coupled into the module via the transmission lines, connection should be made according to the principle explained below.

Connection for 0...20 mA

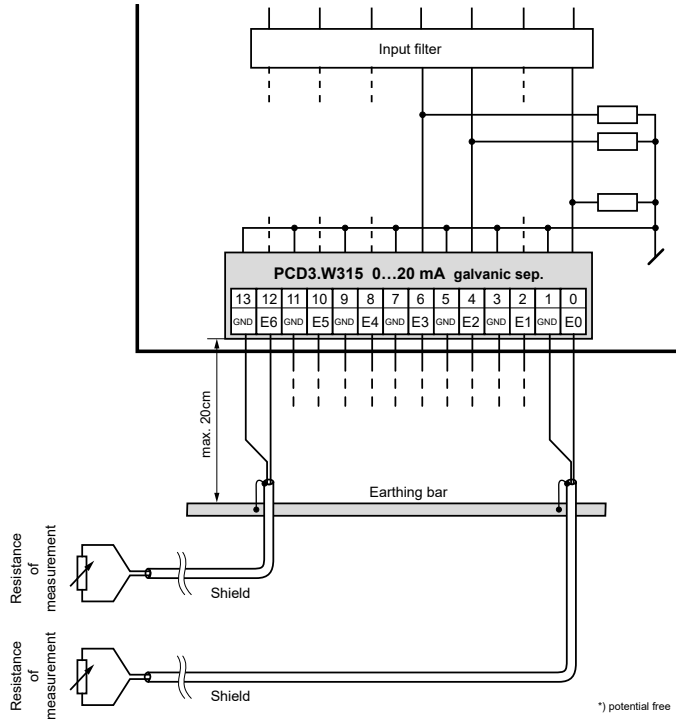

The GND connections are connected together in the module and are galvanically isolated from the CPU. These GNDs must not be connected to the CPU, process GNDs or ground !



If shielded cables are used, the shielding should be connected to an earthing rail.

Connection for 0...20 mA with two-wire transducers

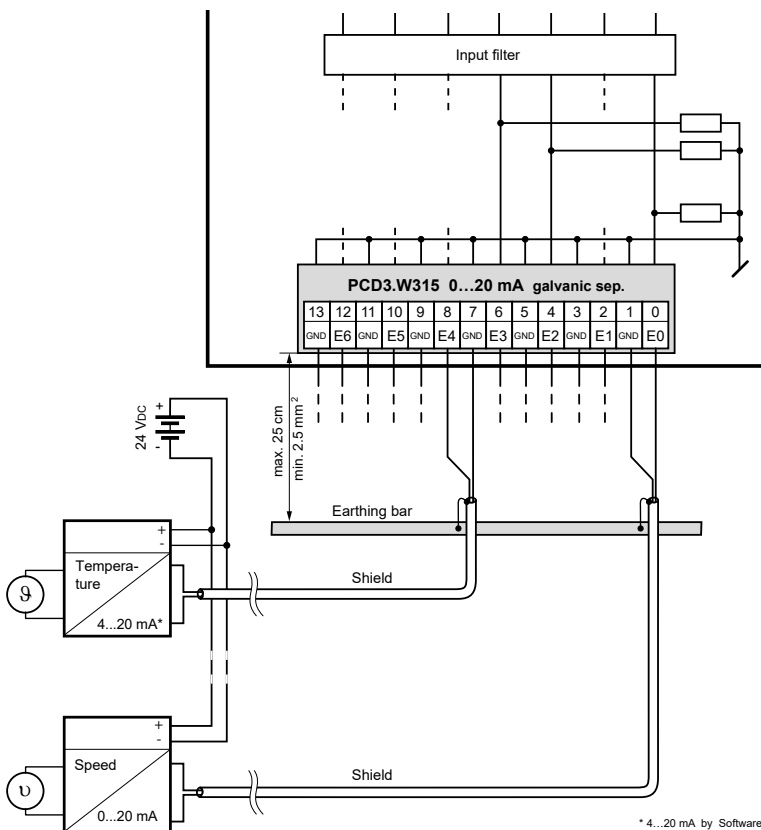

Configuration

Saia PG5® Controls Suite

PCD-System	Evaluation
------------	------------

Classic
 The evaluation is performed by the firmware. It reads the values according to the configuration (Device Configurator or Network Configurator).

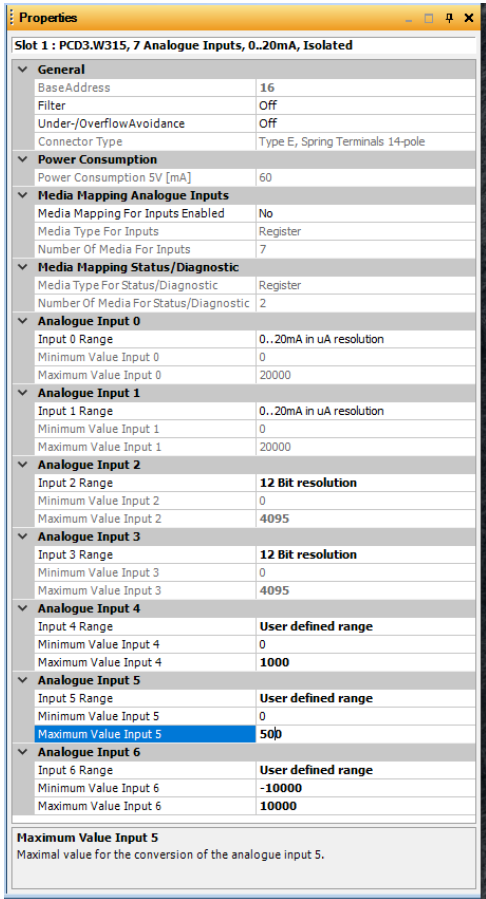

Alternatively
 An FBox "PCD2/3.W3x5" exists for evaluation.
 FBox for PCD3.W315 (Inputs 0...7 selectable)

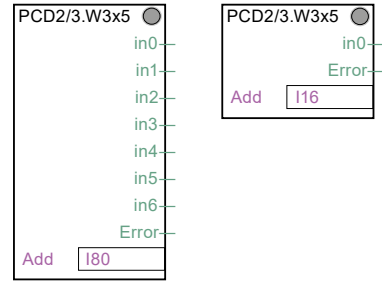

Saia QronoX ECS
 Engineering and Commissioning Suite

PCD-System	Evaluation
------------	------------

IEC-Controller
 The evaluation is performed by the firmware. It reads the values according to the configuration (Device Configurator)

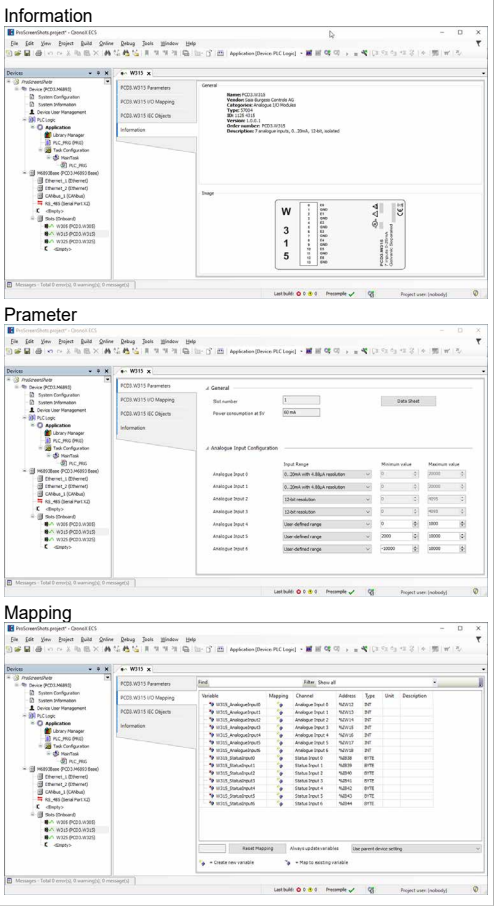

Configuration of the modules

The module has a resolution of 12 bits. This corresponds to 4096 possible measured values.

With a measuring range of 0...20 mA, this results in a resolution of 4,88 $\mu\text{A/bit}$.

The module can output much more precise values than the 12-bit resolution allows by using suitable algorithms (moving averages, etc.). With PG5 and QronoX, a measuring range of 0...20 mA with a resolution of 1 μA is achieved as standard.

In the configurator you can choose whether you want to use the measurement results in μA or in bits.

A user-defined range can also be displayed for special applications. The user can make specifications:

- ▶ Lower value: Displayed value with an input signal of 0 mA.
- ▶ Upper value: Displayed value at an input signal of 20 mA.

Any integer value (-32'768 up to +32'767) can be entered for both values, but the lower value must be smaller than the upper value. However, to avoid error messages when outputting in the extended range (-1% up to +110%), the following values should be used:

- ▶ Lower value: greater than -32'440
- ▶ Upper value: less than +29'490

All values in between are converted directly proportional to these two basic values and indicated as measured value.

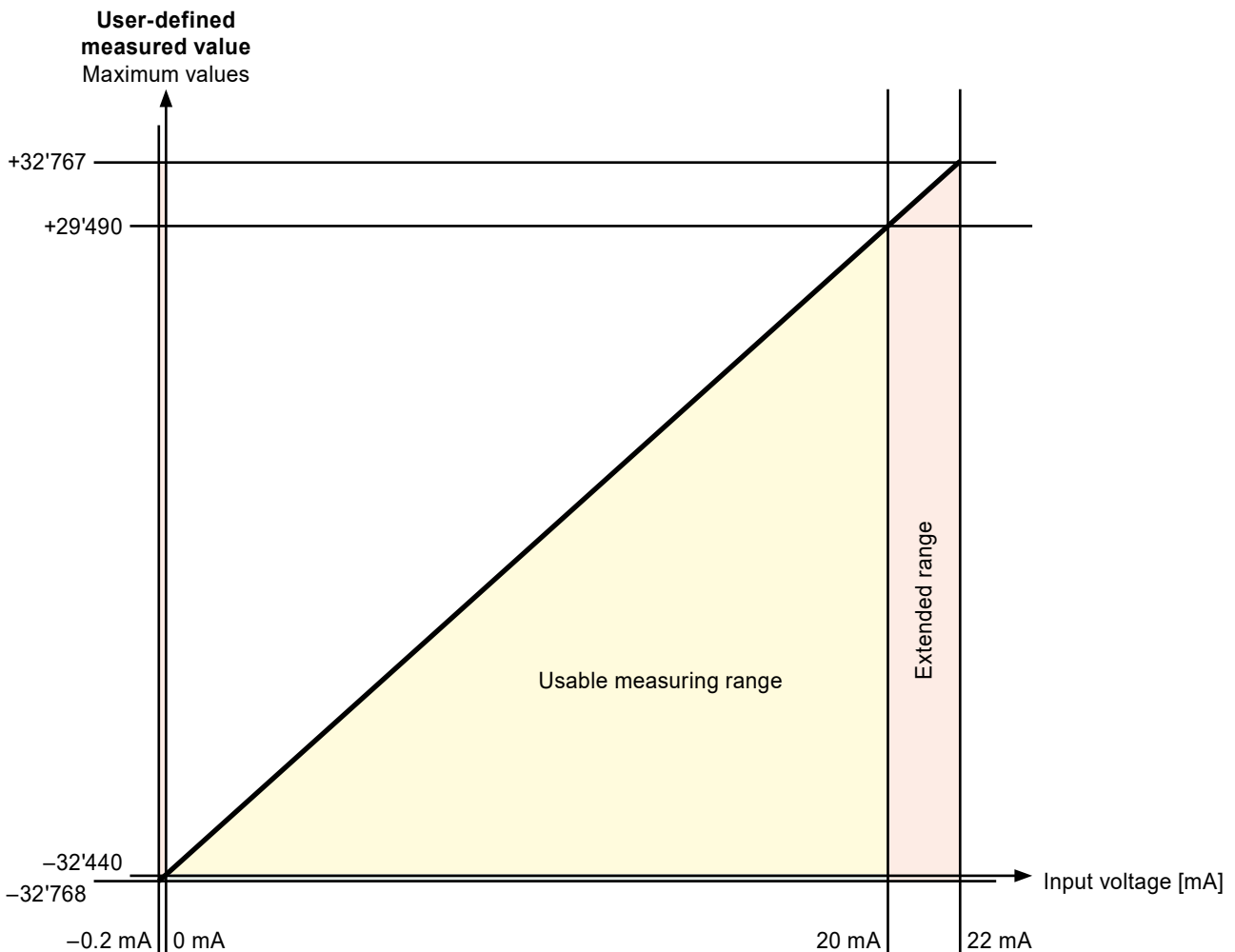

Graph with the maximum possible user-defined measured values

Measurement filter: In the function boxes of PG5, you can select whether the measurement filter for the entire module should be switched on or off (with QronoX, the measurement filter is always activated).

Extended output value format: The module can measure from -1% to +110%. In PG5, the output of the measured values can also be limited to 0...100% (with QronoX, the output of the measured values cannot be limited).

- ▶ If the measured value is below 0 mA, 0 (or the user-defined "lower value") is displayed and the underrange flag is set.
- ▶ If the measured value is above 20 mA, 10000, 4095 bits (or the user-defined "upper value") is displayed and the overrange flag is set.

The modules can also be used on old PCD controllers with Step@7 compatible operating systems (Saia® PCD series xx7) (See table).

Input signals [mA]	12 bit resolution	0...20mA in 1 µV resolution	xx7	Simatic
0	0	0	0	0
8	1637	4000	1638	11074
10	2047	5000	2047	13842
20	4095	10000	4095	27684

Media mapping - symbol name and description

Error register

To use the module diagnosis in the programme, the error output can be used. The meaning of the bits is as follows:

Error register	31	30	29	28	27	26	25	24	23	22	21	20	19	18	17	16	15	14	13	12	11	10	9	8	7	6	5	4	3	2	1	0
Bit	No response from the W3x5 module.	Initialisation failed	Calibration error	Internal error	Not used	Not used	Overrange	Underrange	Not used	Not used	Overrange	Underrange	Not used	Not used	Overrange	Underrange	Not used	Not used	Overrange	Underrange	Not used	Not used	Overrange	Underrange	Not used	Not used	Overrange	Underrange	Not used	Not used	Overrange	Underrange
Nibble	7				6				5				4				3				2				1				0			
	Module Diagnosis				Channel 6 Diagnostic				Channel 5 Diagnostic				Channel 4 Diagnostic				Channel 3 Diagnostic				Channel 2 Diagnostic				Channel 1 Diagnostic				Channel 0 Diagnostic			



Galvanic separation of inputs to CPU, channels themselves not separated.



I/O modules and I/O terminal blocks may only be plugged in and removed when the CPU and the external +24 V are disconnected from the power supply.



Further information

This can be found in the Manual "27-600_I/O-modules for PCD1 / PCD2 series and for PCD3".

**ATTENTION**

These devices must only be installed by a professional electrician, otherwise there is the risk of fire or the risk of an electric shock.

**WARNING**

Product is not intended to be used in safety critical applications, using it in safety critical applications is unsafe.

**WARNING - SAFETY**

The unit is not suitable for the explosion-proof areas and the areas of use excluded in EN 61010 Part 1.

**WARNING - SAFETY**

Check compliance with nominal voltage before commissioning the device (see type label). Check that connection cables are free from damage and that, when wiring up the device, they are not connected to voltage. Do not use a damaged device !

**NOTE**

In order to avoid moisture in the device due to condensate build-up, acclimatise the device at room temperature for about half an hour before connecting.

**CLEANING**

The device can be cleaned in dead state with a dry cloth or cloth soaked in soap solution. Do not use caustic or solvent-containing substances for cleaning.

**MAINTENANCE**

These devices are maintenance-free.
If damaged during, no repairs should be undertaken by the user.

**GUARANTEE**

Opening the module invalidates the guarantee.



Observe this instructions (data sheet) and keep them in a safe place.
Pass on the instructions (data sheet) to any future user.

**WEEE Directive 2012/19/EC Waste Electrical and Electronic Equipment directive**

The product should not be disposed of with other household waste. Check for the nearest authorized collection centers or authorized recyclers. The correct disposal of end-of-life equipment will help prevent potential negative consequences for the environment and human health.



EAC Mark of Conformity for Machinery Exports to Russia, Kazakhstan or Belarus.



PCD3.W315



4 405 4998 0

Ordering information

Type	Short description	Description	Weight
PCD3.W315	7 analogue inputs, 0...20 mA, 12 bit, electrical isolation	Analog input module with electrical isolation, 7 channels (the channels are not isolated from each other), resolution 12 bit, range 0...20 mA, connection with pluggable spring terminals, connector type E (4 405 4998 0) supplied	100 g

Ordering information equipment

Type	Short description	Description	Weight
4 405 4998 0	Plug-in, type E	Plug-in I/O spring terminal block, 14-pole up to 1.5 mm ² , labelled 0 ... 13	13 g

Saia-Burgess Controls AG
 Route Jo-Siffert 4 | 1762 Givisiez, Switzerland
 T +41 26 580 30 00 | F +41 26 580 34 99
 www.saia-pcd.com
 support@saia-pcd.com | www.sbc-support.com

Honeywell | Partner Channel