

M6435A, M7435F Spring Return Actuators FOR CARTRIDGE GLOBE VALVES

INSTALLATION INSTRUCTIONS

INSTALLATION

When Installing this Product...

1. Read these instructions carefully. Failure to follow them could damage the product or cause a hazardous condition.
2. Check ratings given in instructions and on the product to ensure the product is suitable for your application.
3. Installer must be a trained, experienced service technician.
4. After installation is complete, check out product operation as provided in these instructions.



CAUTION

Electrical Shock or Equipment Damage Hazard.
Can shock individuals or short equipment circuitry.

Disconnect power supply before installation.

IMPORTANT

A low-force (40.5 lb [180 N]) actuator installed on a valve larger than 3/4 in. cannot operate the valve.

Location

Select a location where the valve and actuator are accessible.

Mounting

No tools are required to install the actuators on valves because they are threaded onto the valve by hand.



CAUTION

Careless Installation Hazard.
Forcibly tightening the mounting connection can damage the valve and actuator.
Never tighten the connection with a wrench.

Fig. 2 shows the M6435A, M7435F valve position indicator. To mount the actuator, refer to Fig. 3 through 4:

1. Remove valve protective cover (Fig. 3).
2. Make sure the actuator is in the (factory-supplied) OPEN position.
3. Screw the actuator connector onto the body of the valve (Fig. 4).

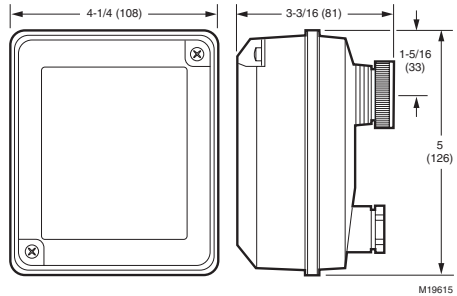

Fig. 1. Approximate dimensions in in. (mm).

Wiring

Connect the actuator to the controller using the wiring diagram for the controller. See Fig. 5 for typical hookup to T6984F.

Use the M7435F with Excel[®] 5000/500/100/80 Controllers, T7984, and W7751 controllers. Power the M7435F from the same transformer as the controller when using Excel Systems, or T7984 Controllers, when the common lines from the controller and the actuator are connected together and the hot side of the 24 Vac power connection on the transformer is used. See Fig. 6.

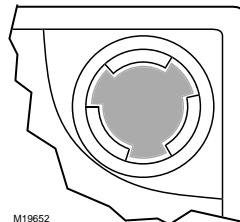
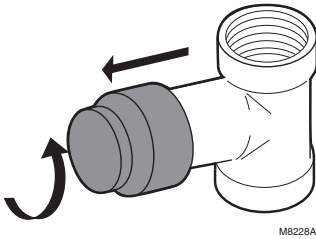

Fig. 2. Valve position indicator.





M8228A

Fig. 3. Removing protective cover from valve.

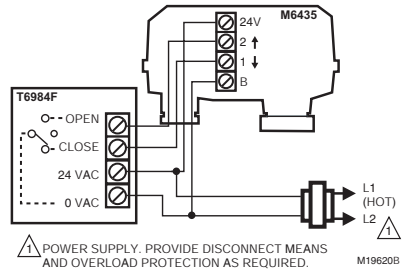

M19620B

Fig. 5. M6435A used with T6984F.

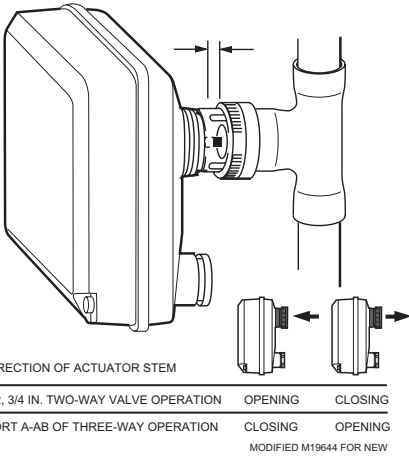
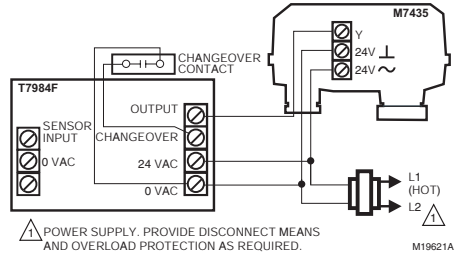

Fig. 4. Mounting actuator to valve.



M19621A

Fig. 6. M7435F used with T7984F.

Switch Selection (M7435F)

The two built-in selector switches must be set according to the desired valve action and the controller output signal (0 to 10V or 2 to 10V). See Fig. 7.

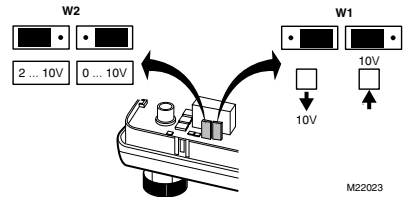

M22023

Fig. 7. Switch selection according to controller output signal and valve type (two-way or three-way).

Honeywell

Automation and Control Solutions

Honeywell International Inc.
1985 Douglas Drive North
Golden Valley, MN 55422

Honeywell Limited-Honeywell Limitée
35 Dynamic Drive
Scarborough, Ontario
M1V 4Z9

By using this Honeywell literature, you agree that Honeywell will have no liability for any damages arising out of your use or modification to, the literature. You will defend and indemnify Honeywell, its affiliates and subsidiaries, from and against any liability, cost, or damages, including attorneys' fees, arising out of, or resulting from, any modification to the literature by you.

