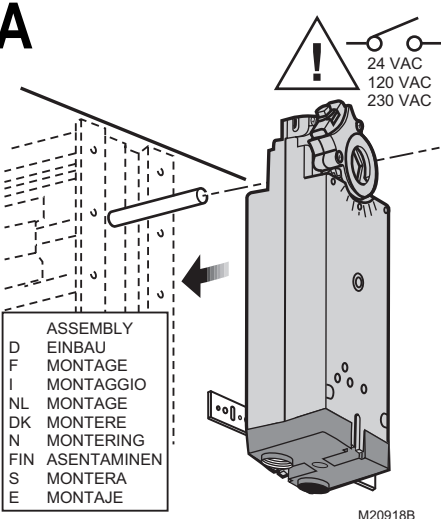
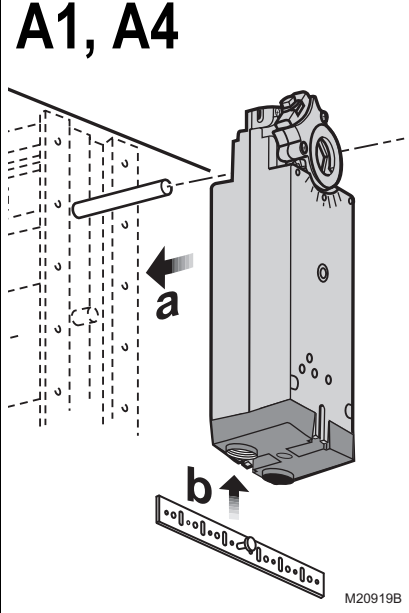
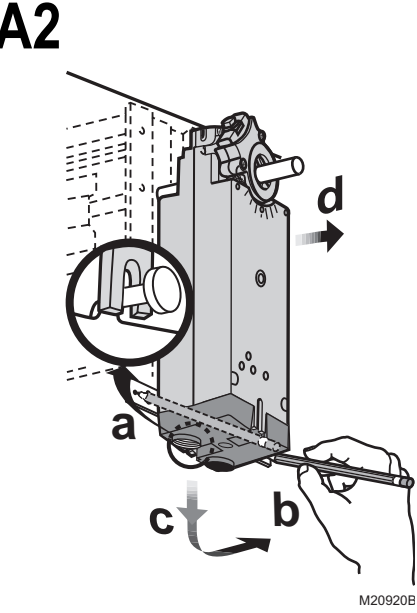
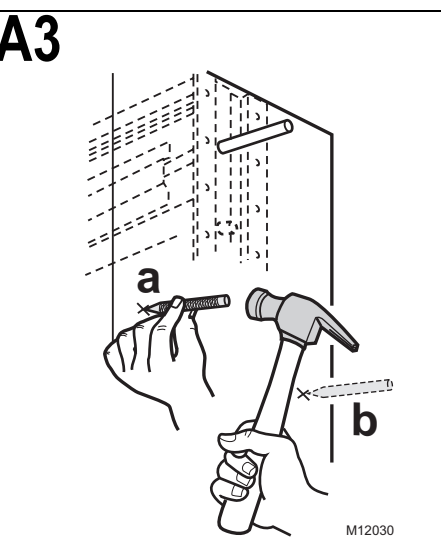
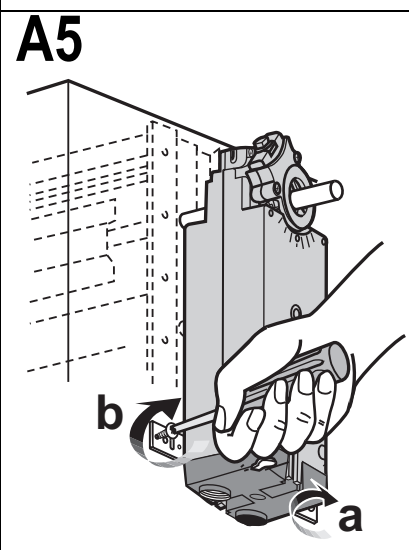
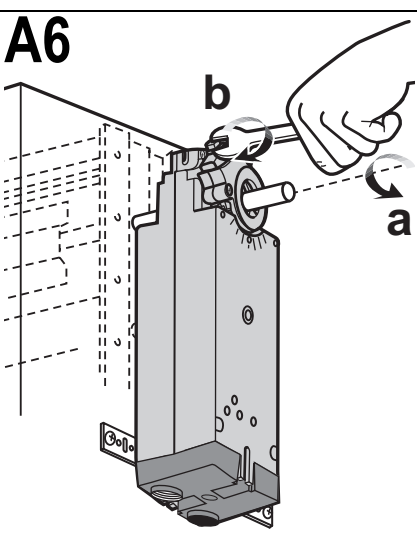

- D Montageanweisung
- F Instructions d'Installation
- I Istruzioni per l'Installazione
- NL Installatievoorschrift
- DK Installasjonsinstruks
- N Installationsinstruktioner
- SF Asennusohje
- S Installations Instruktioner
- E Instrucciones de montaje

S05, S10, S20 Series Spring Return Direct Coupled Actuators

MS31XX, MS41XX, MS46XX, MS71XX, MS75XX, MS81XX

INSTALLATION INSTRUCTIONS

<p>A</p>  <p>ASSEMBLY D EINBAU F MONTAGE I MONTAGGIO NL MONTAGE DK MONTERE N MONTERING FIN ASENTAMINEN S MONTERA E MONTAJE</p> <p>M20918B</p>	<p>A1, A4</p>  <p>M20919B</p>	<p>A2</p>  <p>M20920B</p>
<p>A3</p>  <p>M12030</p>	<p>A5</p>  <p>M20921B</p>	<p>A6</p>  <p>M20922B</p>



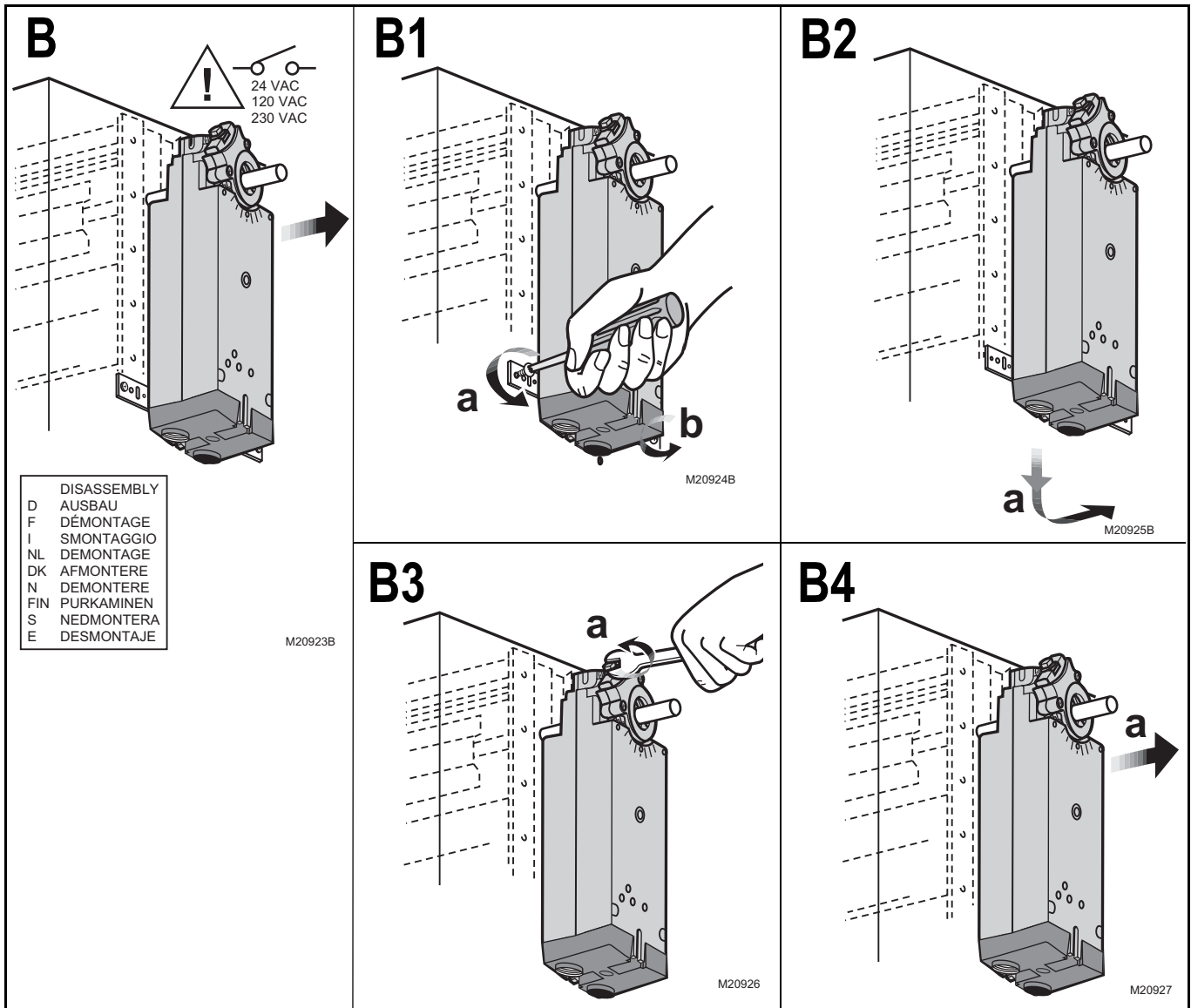

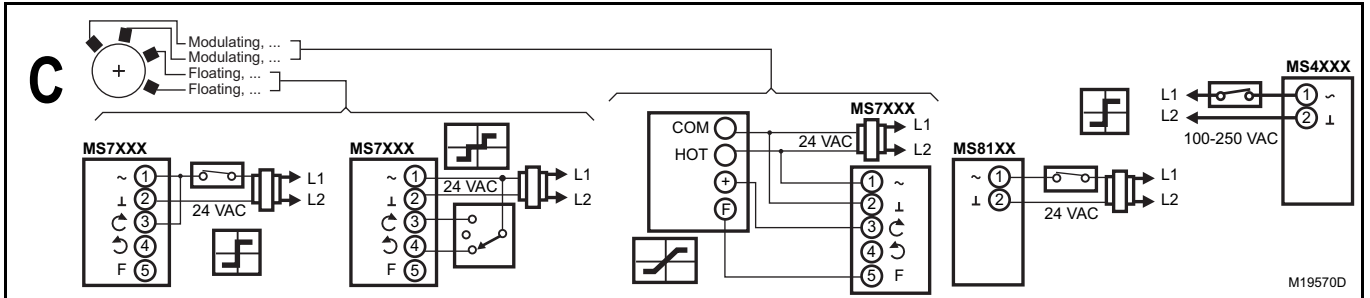

The internal auxiliary switches must be connected to the same power source, the auxiliary switches shall be connected to the same pole of the same supply circuit, connected in a same polarity manner.

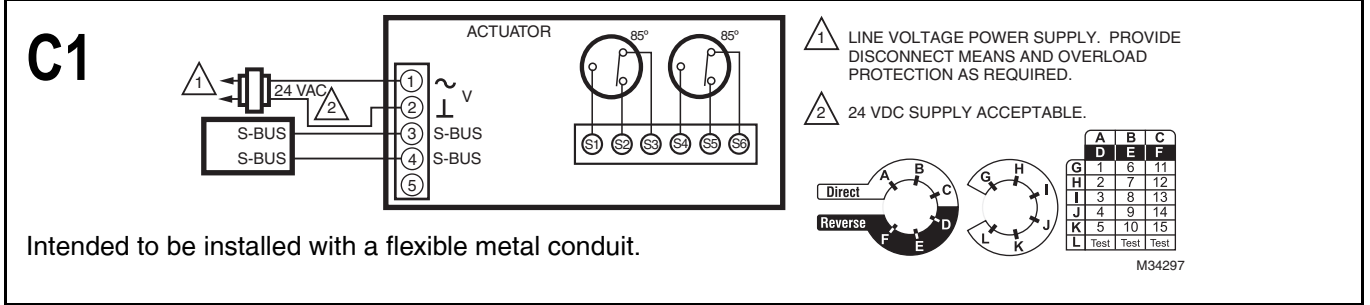

Intended to be installed with a flexible metal conduit.

For additional installation details go to customer.honeywell.com and search for Literature Number 63-2607.

Automation and Control Solutions

Honeywell International Inc.
1985 Douglas Drive North
Golden Valley, MN 55422
customer.honeywell.com

By using this Honeywell literature, you agree that Honeywell will have no liability for any damages arising out of your use or modification to, the literature. You will defend and indemnify Honeywell, its affiliates and subsidiaries, from and against any liability, cost, or damages, including attorneys' fees, arising out of, or resulting from, any modification to the literature by you.

© U.S. Registered Trademark
© 2014 Honeywell International Inc.
62-0188—09 M.S. Rev. 01-14
Printed in United States

Honeywell