



# PERFORMANCE SERIES IP HEW2PER2\*/HEW4PER2\*/HEW8PER2\* WDR IR Ball Camera





## Quick Installation Guide

(The last "\*" represents V or L, and other numbers or letters)

Thank you for purchasing a Honeywell Performance Series IP camera. Follow the instructions in this guide to install and log in to your camera. For instructions on configuring the camera, refer to the user guide on the DVD that came with your camera. If you require additional assistance, call the number listed for your region on the back cover.



## Cautions and Warnings

	<b>CAUTION</b> RISK OF ELECTRIC SHOCK DO NOT OPEN			THIS SYMBOL INDICATES THAT DANGEROUS VOLTAGE CONSTITUTING A RISK OF ELECTRIC SHOCK IS PRESENT WITHIN THE UNIT.
CAUTION: TO REDUCE THE RISK OF ELECTRIC SHOCK, DO NOT REMOVE THE COVER. NO USER-SERVICEABLE PARTS INSIDE. REFER SERVICING TO QUALIFIED SERVICE PERSONNEL.			THIS SYMBOL INDICATES THAT IMPORTANT OPERATING AND MAINTENANCE INSTRUCTIONS ACCOMPANY THIS UNIT.	

**WARNING** To ensure compliance with electrical safety standards, this product is intended for use with a Listed Power Adapter marked "Limited Power Source" or "LPS" on the unit, output rated to 12 VDC, minimum 0.33 A, TMA=60 deg C, or from Power over Ethernet (PoE) provided by Listed Information Technology Equipment meeting IEEE 802.3af PoE standard.

**CAUTION** The Ethernet connection is not intended to be connected to exposed (outside plant) networks. Do not connect two power sources to the camera at the same time.

**CAUTION** Invisible LED radiation (850 nm). Avoid exposure to beam.

## Important Safeguards

- Read and keep these instructions.
- Confirm the installation surface can support at least three times the weight of the camera.

- Do not aim the camera toward a bright light source for extended periods to prevent damage to the imager.
- Avoid operating the unit under or close to unstable light sources (may cause flickering), or close to fluorescent lamps or objects reflecting light.
- Do not touch the camera lens.
- Do not drop the camera or subject it to physical shock.
- Do not use a strong or abrasive detergent when cleaning the camera.
- Avoid operating or storing the unit in extremely humid, dusty, hot/cold environments, where the operating temperature is outside the recommended range of -22°F to 140°F (-30°C to 60°C).
- Do not apply power to the camera before completing installation.

## Before You Begin

Before you begin, check that you have received all of the parts listed below. If any parts are missing or damaged, contact your dealer immediately.

- Camera
- Installation DVD
- Quick Installation Guide
- Allen Key (L-wrench)
- Self-tapping Screws (×4)
- Plastic Wall Anchors (×4)
- Mounting Template

**CAUTION** Installation and servicing should be performed only by qualified and experienced technicians to conform to all local codes and to maintain your warranty.

## Preparing the Mounting Surface

1. Apply the mounting template to the mounting surface.  
**Note** Observe the orientation of the cable exit notch on the bracket base. In outdoor installations, the notch should point downward to prevent water from entering the camera housing.
2. Using the mounting template as a guide, drill three pilot holes in the mounting surface, then hammer the supplied anchors into the holes.
3. Drill a cable entry hole in the mounting surface, then pull the required cables through the hole.

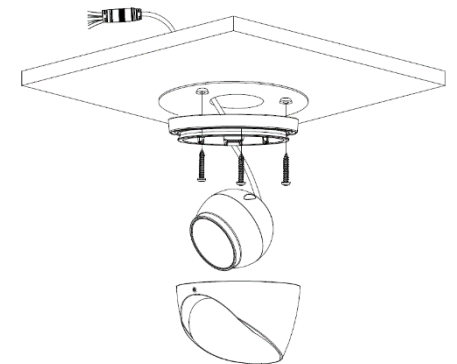

## Mounting and Aiming the Camera

1. Remove the cover from the camera assembly
2. If you are using a microSD card with the camera, install it before continuing. See below for details.

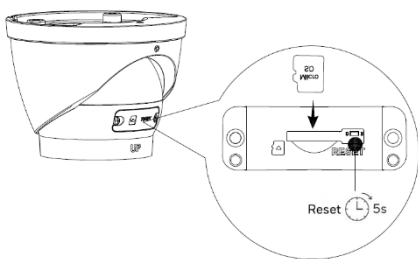

3. Connect the Ethernet cable to the RJ-45 port on the camera.
4. If the other end of the Ethernet cable is not connected to a PoE (Power-over-Ethernet) switch or NVR, connect the power connector of the camera to a 12 VDC power source.
5. Fix the camera assembly to the mounting surface using the supplied screws.
6. Aim the camera lens in the desired direction, then tighten the screws on the camera assembly.
7. Reattach the dome cover.

## Logging On to the Camera

If the camera is connected to the PoE port of a Honeywell Embedded NVR, it can be configured using the NVR.

To log on remotely from a PC, install the Unified Tool from the software and documentation DVD, find the camera on the network, and then open the web browser. The default user name is **admin** (case-sensitive) and the default password is **1234**.

- Note**
- Only Internet Explorer 11 (or later) is supported.
  - IP address of the device is assigned automatically by DHCP server. If the DHCP server is not available, the device will acquire **192.168.1.108** as the default IP address.

## Adjusting the Zoom and Focus Settings

After you have logged on to the camera, go to Setup → Camera → Conditions → Zoom and Focus to fine-tune the camera's zoom and focus settings.

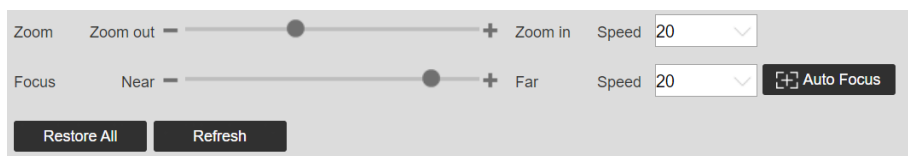

## Recommended Recorders

HEN*4	8/16/32/64-channel Focus 4K NVRs (H.264 and H.265)
HEN*3	4/8/16/32-channel Performance Series NVRs (H.264 and H.265)

## Regulatory Statements

### FCC Compliance

This equipment has been tested and found to comply with the limits for a Class B digital device, pursuant to part 15 of the FCC Rules. These limits are designed to provide reasonable protection against harmful interference in a residential installation. This equipment generates, uses, and can radiate radio frequency energy and, if not installed and used in accordance with the instructions, may cause harmful interference to radio communications. However, there is no guarantee that interference will not occur in a particular installation.

If this equipment does cause harmful interference to radio or television reception, which can be determined by turning the equipment off and on, the user is encouraged to try to correct the interference by one or more of the following measures:

- Reorient or relocate the receiving antenna.
- Increase the separation between the equipment and receiver.
- Connect the equipment into an outlet on a circuit different from that to which the receiver is connected.
- Consult the dealer or an experienced radio/TV technician for help.

**Note** Changes or modifications not expressly approved by the party responsible for compliance could void the user's authority to operate the equipment.

This Class B digital apparatus complies with Canadian ICES-003.

### Manufacturer's Declaration of Conformance

**North America** The equipment supplied with this guide conforms to UL 60950-1 and CSA C22.2 No. 60950-1.

**Europe** The manufacturer declares that the equipment supplied is compliant with the European Parliament and Council Directive on the restriction of the use of certain hazardous substances in electrical and electronic equipment (2015/863/EU), the Low Voltage Directive (2014/35/EU) and the essential requirements of the EMC directive (2014/30/EU), conforming to the requirements of standards EN 55032 for emissions, EN 50130-4 for immunity, and EN 62368-1 for electrical equipment safety.

### WEEE (Waste Electrical and Electronic Equipment)



Correct disposal of this product (applicable in the European Union and other European countries with separate collection systems). This product should be disposed of, at the end of its useful life, as per applicable local laws, regulations, and procedures.

# Honeywell

North America  
715 Peachtree St. NE Atlanta,  
GA 30308

www.security.honeywell.com  
Tel: 1 800 323 4576

Europe  
Newhouse Industrial Estate  
Motherwell Lanarkshire ML1 5SB  
United Kingdom

www.security.honeywell.com/uk  
Tel: +44 (0) 1928 378005

Middle East  
Emaar Business Park, Building No. 2,  
Sheikh Zayed Road  
P.O. Box 232362  
Dubai, United Arab Emirates  
www.security.honeywell.com/me  
Tel: +971 4 450 5800

Document 800-26634-A, 03/2021