

# HE42XD2G TDN 1080p IR Ball Camera



## Quick Installation Guide

Document 800-23521 - Rev C - 08/2017



Thank you for purchasing a Honeywell Performance Series HQA HE42XD2G camera. Follow the instructions in this guide to install and log in to your camera.

## Warnings and Cautions

 <p><b>CAUTION</b> RISK OF ELECTRIC SHOCK DO NOT OPEN</p>	 <p>THIS SYMBOL INDICATES THAT DANGEROUS VOLTAGE CONSTITUTING A RISK OF ELECTRIC SHOCK IS PRESENT WITHIN THE UNIT.</p>
<p>CAUTION TO REDUCE THE RISK OF ELECTRIC SHOCK, DO NOT REMOVE THE COVER. NO USER-SERVICEABLE PARTS INSIDE. REFER SERVICE TO QUALIFIED SERVICE PERSONNEL.</p>	 <p>THIS SYMBOL INDICATES THAT IMPORTANT OPERATING AND MAINTENANCE INSTRUCTIONS ACCOMPANY THIS UNIT.</p>

**WARNING** This device is configured for 12 VDC operation. Do not connect to a higher voltage. Use only with NRTL-approved Class 2 power supplies.

**CAUTION** IR emitted from this product. Do not view directly with optical instruments. Do not stare directly into the lamp at a distance of less than 3.3 ft (1 m).

**CAUTION** Class 1 LED product. Invisible LED radiation (850 nm). Avoid exposure to beam.

## Important Safeguards

- Read and keep these instructions.
- Confirm the installation surface can support at least three times the weight of the camera.
- Do not apply power to the camera before completing installation.
- Do not aim the camera toward a bright light source for extended periods.
- Avoid operating the unit under or close to unstable light sources (may cause flickering), or close to fluorescent lamps or objects reflecting light.
- Do not touch the camera lens.
- Do not drop the camera or subject it to physical shock.
- Do not use a strong or abrasive detergent when cleaning the camera.
- Avoid operating or storing the unit in extremely humid, dusty, hot/cold environments, where the operating temperature is outside the recommended range of -40°F to 140°F (-40°C to 60°C).

## Before You Begin

Before you begin, check that you have received all of the parts listed below. If any parts are missing or damaged, contact your dealer immediately.

- Camera
- Mounting template
- Self-tapping screws (×5)
- Plastic anchors (×5)
- Hex key (L-wrench)
- Power pigtail

**CAUTION** Installation and servicing should be performed only by qualified and experienced technicians to conform to all local codes and to maintain your warranty.

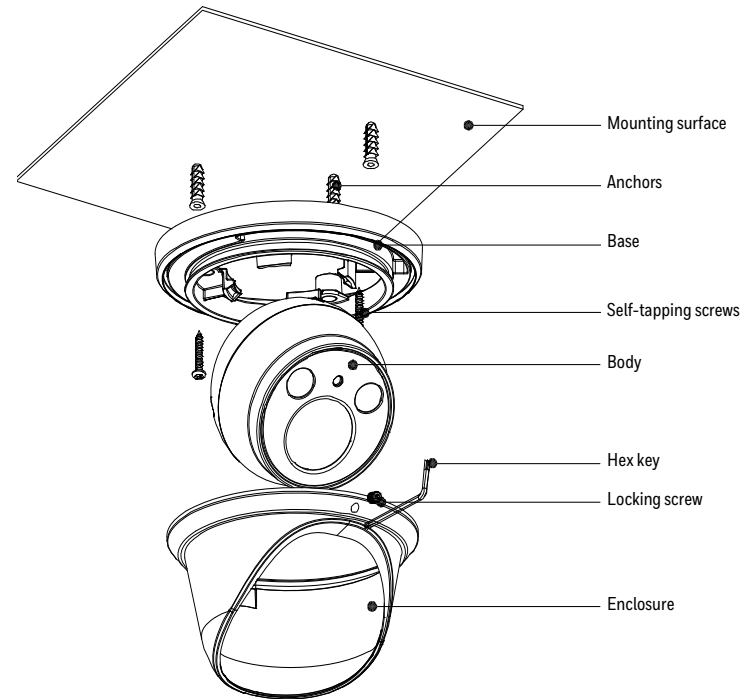

## Preparing the Mounting Surface

1. Apply the mounting template to the mounting surface.
2. Using the mounting template as a guide, drill four pilot holes in the mounting surface, then hammer the supplied anchors into the holes.
3. Drill a cable entry hole in the mounting surface, then pull the required cables through the hole.

## Mounting the Camera

1. Loosen the locking screw on the enclosure and unscrew the camera assembly from the base.
2. Fix the base to the mounting surface using the supplied screws.
3. Connect the camera's BNC connector to a coaxial cable.
4. The default video format is HQA/CVI. Use the DIP switch on the camera cable to change formats.

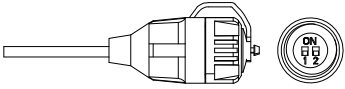

	1	2
<b>CVI</b>	OFF	OFF
<b>SD</b>	ON	ON
<b>AHD</b>	ON	OFF
<b>TVI</b>	OFF	ON

5. Connect the camera's power connector to a 12 VDC source.
6. Reattach the camera assembly to the camera base.
7. Rotate the camera body and enclosure to achieve the desired view.
8. Tighten the locking screw on the enclosure.

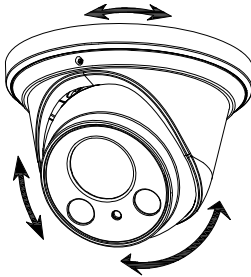

## Configuring the Camera

1. Connect the camera to a Honeywell Performance Series HQA DVR and log on as the admin user.
2. Right-click to display the shortcut menu, then click **Camera Menu**. The **Menu Operation** window opens.
3. Click **Enter** to display the camera's OSD menu.
4. To configure the camera, in the **Menu Operation** window, click the up/down arrows to move through the menu list, click the left/right arrows to change a menu setting, or click **Enter** to enter a submenu (↵) or execute a command.
5. After you have finished configuring the camera, scroll down to **Exit**, and then click **Enter** to exit the OSD menu. Right-click to close the **Menu Operation** window.

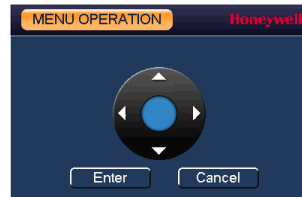

## Recommended Recorders

<b>HRHQ104*</b>	4-channel, 1 SATA, 720p@120fps, 1080p@60fps, alarm I/O
<b>HRHQ108*</b>	8-channel, 2 SATA, 720p@240fps, 1080p@120fps, alarm I/O
<b>HRHQ116*</b>	16-channel, 2 SATA, 720p@480fps, 1080p@240fps, alarm I/O
<b>HRHT404*</b>	4-channel, 1 SATA, 4 MP, HQA/1080p@60fps, HQA/SD/IP@120fps
<b>HRHT408*</b>	8-channel, 2 SATA, 4 MP, HQA/1080p@120fps, HQA/SD/IP@120fps
<b>HRHT416*</b>	16-channel, 2 SATA, 4 MP, HQA/1080p@240fps, HQA/SD/IP@120fps

## Regulatory Statements

### FCC Compliance

**Information to the User:** This equipment has been tested and found to comply with the limits for a Class B digital device, pursuant to part 15 of the FCC Rules. These limits are designed to provide reasonable protection against harmful interference in a residential installation. This equipment generates, uses, and can radiate radio frequency energy and, if not installed and used in accordance with the instructions, may cause harmful interference to radio communications. However, there is no guarantee that interference will not occur in a particular installation.

If this equipment does cause harmful interference to radio or television reception, which can be determined by turning the equipment off and on, the user is encouraged to try to correct the interference by one or more of the following measures:

- Reorient or relocate the receiving antenna.
- Increase the separation between the equipment and receiver.
- Connect the equipment into an outlet on a circuit different from that to which the receiver is connected.
- Consult the dealer or an experienced radio/TV technician for help.

Changes or modifications not expressly approved by the party responsible for compliance could void the user's authority to operate the equipment.

This Class B digital apparatus complies with Canadian ICES-003.

Cet appareil numérique de la Classe B est conforme à la norme NMB-003 du Canada.

### Manufacturer's Declaration of Conformance

**Europe** The manufacturer declares that the equipment supplied is compliant with the European Parliament and Council Directive on the restriction of the use of certain hazardous substances in electrical and electronic equipment (2011/65/EU), General Product Safety Directive (2001/95/EC), and the essential requirements of the EMC directive (2014/30/EU), conforming to the requirements of standards EN 55032 for emissions, EN 50130-4 for immunity, and EN 60950-1 for electrical equipment safety.

### WEEE (Waste Electrical and Electronic Equipment)



Correct disposal of this product (applicable in the European Union and other European countries with separate collection systems). This product should be disposed of, at the end of its useful life, as per applicable local laws, regulations, and procedures.

# Honeywell

2700 Blankenbaker Pkwy, Suite 150  
Louisville, KY, 40299, USA  
[www.honeywell.com/security](http://www.honeywell.com/security)  
+1 800 323 4576  
(North America only)

Aston Fields Road, Whitehouse Industrial Estate  
Runcorn, Cheshire, WA7 3DL, UK  
[www.honeywell.com/security/uk](http://www.honeywell.com/security/uk)  
+1 44 (0) 1928 754 028  
(Europe only)

35F Tower A, City Center, 100 Zunyi Road  
Shanghai, 200051, China  
[www.asia.security.honeywell.com](http://www.asia.security.honeywell.com)  
+86 21 221 96888  
(Asia Pacific only)

Document 800-23521 – Rev C – 08/2017