

M500S Supervised Control Module

SPECIFICATIONS

Normal Operating Voltage:	15 to 32 VDC
Maximum Current Draw:	6.5mA (LED On)
Operating Current:	350 µA max., 1 communication every 5 seconds 47k EOL resistor; 485 µA max. (Communicating, NAC Shorted)
Maximum NAC Line Loss:	4 VDC
External Supply Voltage (between Terminals T3 and T4)	
Maximum (NAC):	Regulated 24VDC
Maximum (Speakers):	70.07 V RMS, 50 W
Max. NAC Current Ratings:	For class B wiring system, the current rating is 3A; For class A wiring system, the current rating is 2A
Temperature Range:	32°F to 120°F (0°C to 49°C)
Humidity:	10% to 93% Non-condensing
Dimensions:	4 1/2" H × 4" W × 1 1/4" D (Mounts to a 4" square by 2 1/8" deep box.)
Accessories:	SMB500 Electrical Box; CB500 Barrier

BEFORE INSTALLING

This information is included as a quick reference installation guide. Refer to the control panel installation manual for detailed system information. If the modules will be installed in an existing operational system, inform the operator and local authority that the system will be temporarily out of service. Disconnect power to the control panel before installing the modules.

NOTICE: This manual should be left with the owner/user of this equipment.

GENERAL DESCRIPTION

M500S Supervised Control Modules are intended for use in intelligent, two-wire systems, where the individual address of each module is selected using the built-in rotary decade switches. This module is used to switch an external power supply, which can be a DC power supply or an audio amplifier (up to 80 VRMS), to notification appliances. It also supervises the wiring to the connected loads and reports their status to the panel as NORMAL, OPEN, or SHORT CIRCUIT. The M500S has two pairs of output termination points available for fault-tolerant wiring and a panel-controlled LED indicator. This module can be used to replace an M500C module that has been configured for supervised wiring operation.

COMPATIBILITY REQUIREMENTS

To ensure proper operation, these modules shall be connected to listed compatible system control panels only.

FIGURE 1. CONTROLS AND INDICATORS:

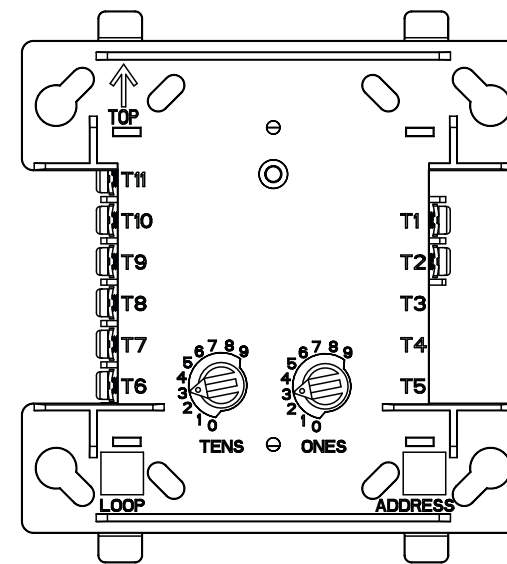

FIGURE 2A. MODULE MOUNTING WITH BARRIER:

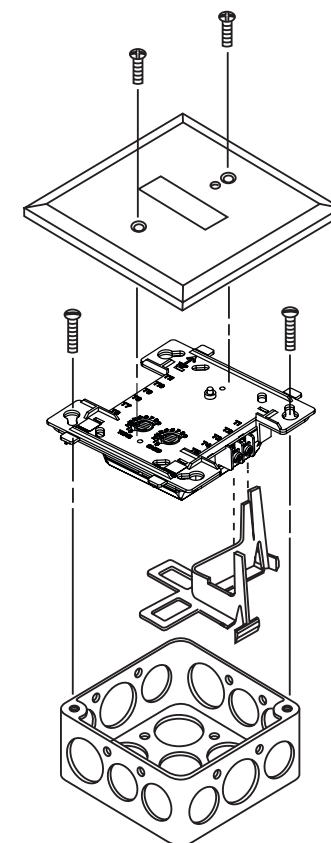
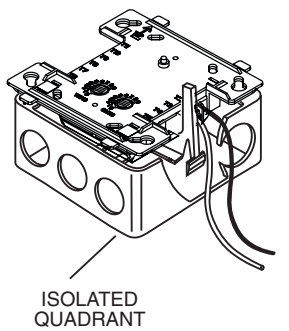

FIGURE 2B:



C1050-00

WIRING

NOTE: All wiring must conform to applicable local codes, ordinances, and regulations. When using control modules in nonpower limited applications, the System Sensor CB500 Module Barrier must be used to meet UL requirements for the separation of power-limited and nonpower-limited terminals and wiring. The barrier must be inserted into a 4" × 4" × 2 1/8" junction box, and the control module must be placed into the barrier and attached to the junction box (Figure 2A). The power-limited wiring must be placed into the isolated quadrant of the module barrier (Figure 2B).

1. Install module wiring in accordance with the job drawings and appropriate wiring diagrams.
2. Set the address on the module per job drawings.
3. Secure module to electrical box (supplied by installer), as shown in Figure 2A.

WARNING

All relay switch contacts are shipped in the standby state (open) state, but may have transferred to the activated (closed) state during shipping. To ensure that the switch contacts are in their correct state, modules must be made to communicate with the panel before connecting circuits controlled by the module.

THREE-YEAR LIMITED WARRANTY

System Sensor warrants its enclosed module to be free from defects in materials and workmanship under normal use and service for a period of three years from date of manufacture. System Sensor makes no other express warranty for this module. No agent, representative, dealer, or employee of the Company has the authority to increase or alter the obligations or limitations of this Warranty. The Company's obligation of this Warranty shall be limited to the repair or replacement of any part of the module which is found to be defective in materials or workmanship under normal use and service during the three year period commencing with the date of manufacture. After phoning System Sensor's toll free number 800-SENSOR2 (736-7672) for a Return Authorization number, send defective units postage prepaid to: System Sensor, Repair Department, RA

_____, 3825 Ohio Avenue, St. Charles, IL 60174. Please include a note describing the malfunction and suspected cause of failure. The Company shall not be obligated to repair or replace units which are found to be defective because of damage, unreasonable use, modifications, or alterations occurring after the date of manufacture. In no case shall the Company be liable for any consequential or incidental damages for breach of this or any other Warranty, expressed or implied whatsoever, even if the loss or damage is caused by the Company's negligence or fault. Some states do not allow the exclusion or limitation of incidental or consequential damages, so the above limitation or exclusion may not apply to you. This Warranty gives you specific legal rights, and you may also have other rights which vary from state to state.

C0909-01

MOUNTING

The M500S mounts directly to 4-inch square electrical boxes (see Figure 2A). The box must have a minimum depth of 2 1/8 inches. Surface mounted electrical boxes (SMB500) are available from System Sensor.

FIGURE 3. TYPICAL NOTIFICATION APPLIANCE CIRCUIT CONFIGURATION, NFPA STYLE Y:

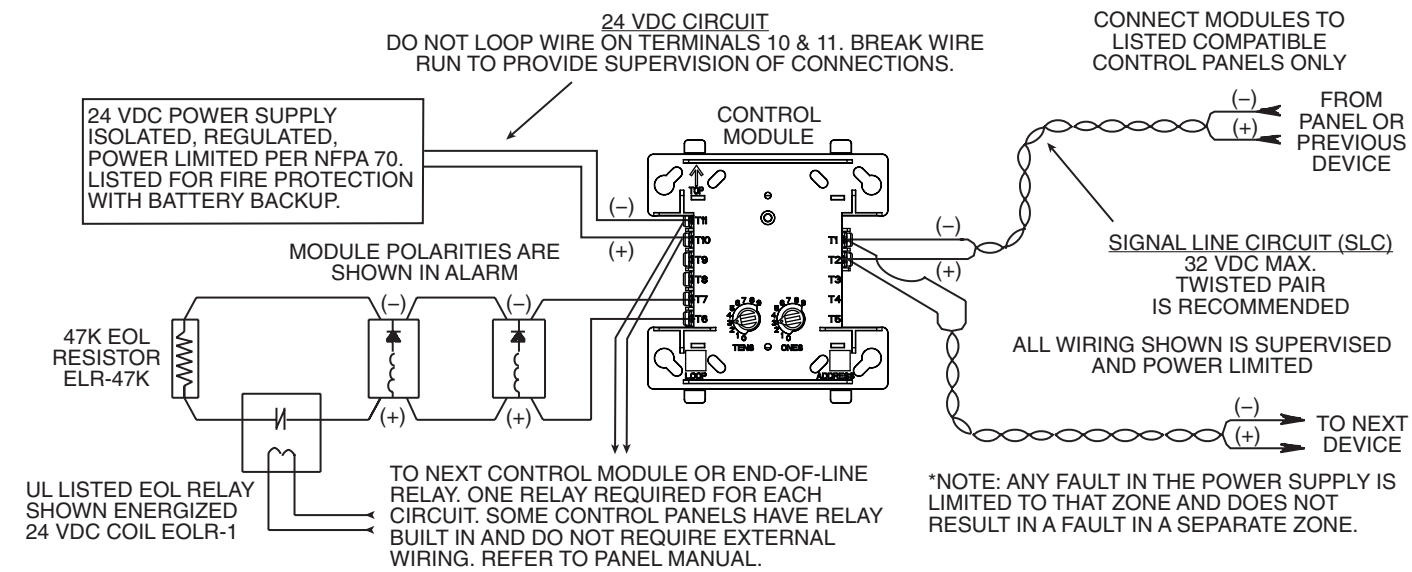

C0913-05

FIGURE 4. TYPICAL FAULT TOLERANT NOTIFICATION APPLIANCE CIRCUIT CONFIGURATION, NFPA STYLE Z:

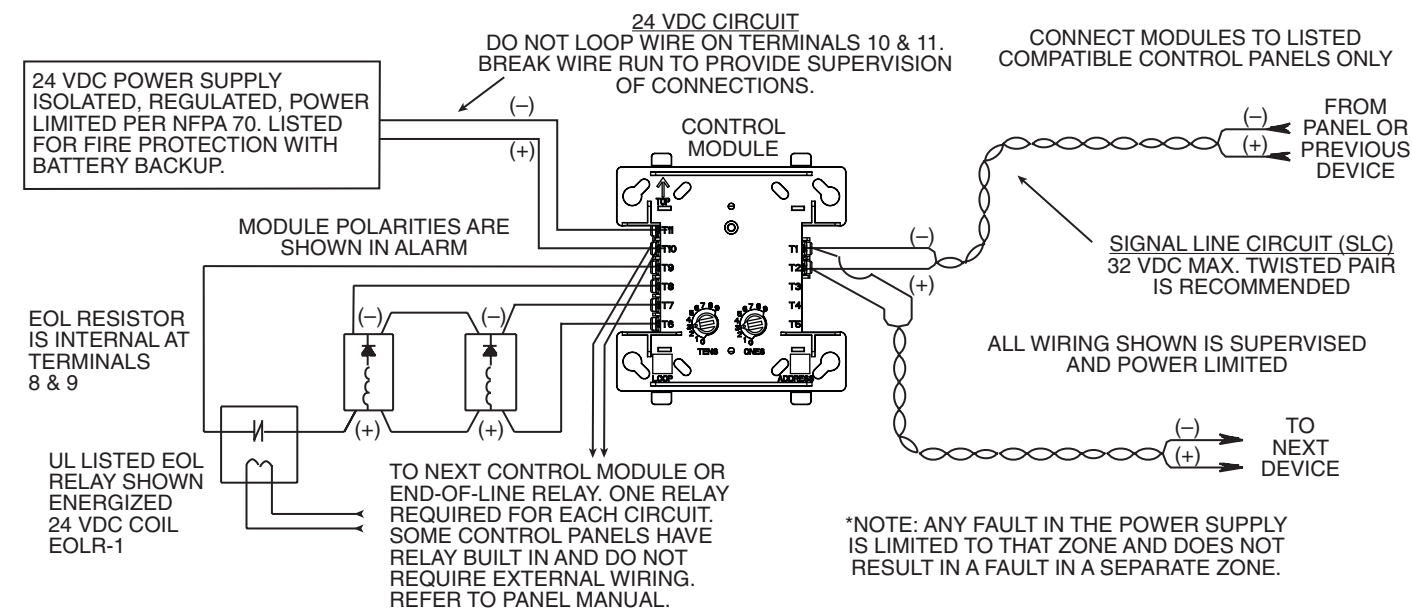

C0914-05

FIGURE 5. TYPICAL WIRING FOR SPEAKER SUPERVISION AND SWITCHING, NFPA STYLE Y:

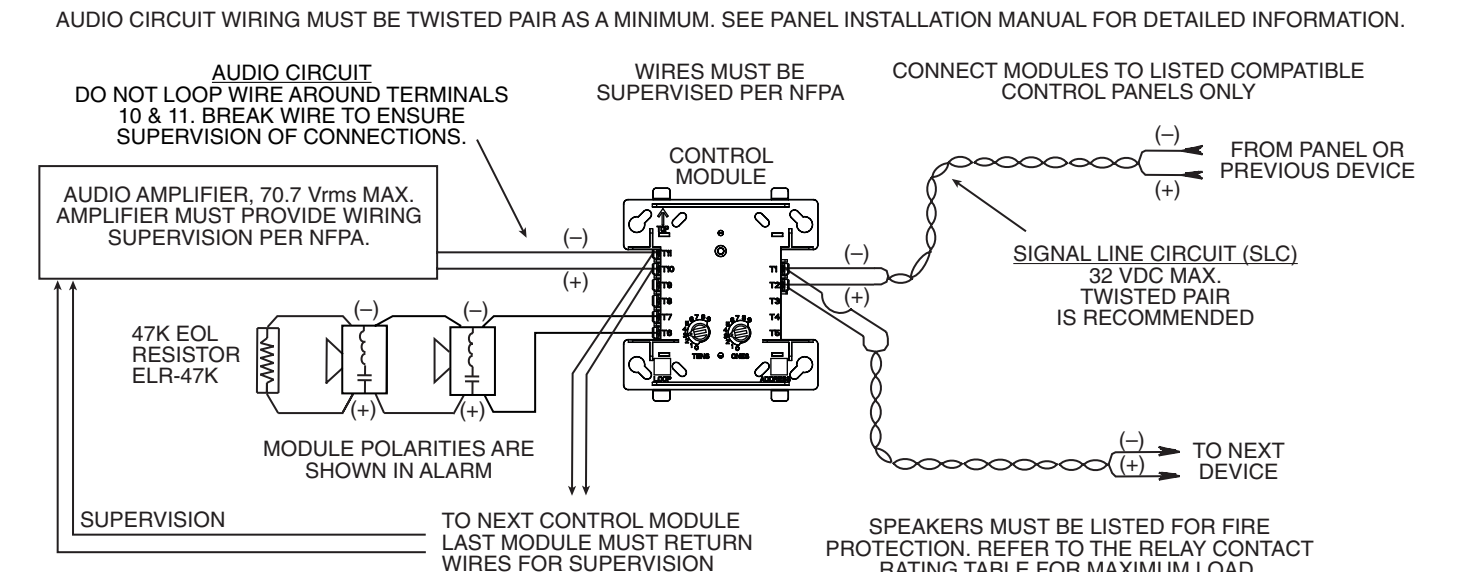

*NOTE: ANY FAULT IN THE POWER SUPPLY IS LIMITED TO THAT ZONE AND DOES NOT RESULT IN A FAULT IN A SEPARATE ZONE.

C0915-03

FIGURE 6. TYPICAL FAULT TOLERANT WIRING FOR SPEAKER SUPERVISION AND SWITCHING, NFPA STYLE Z:

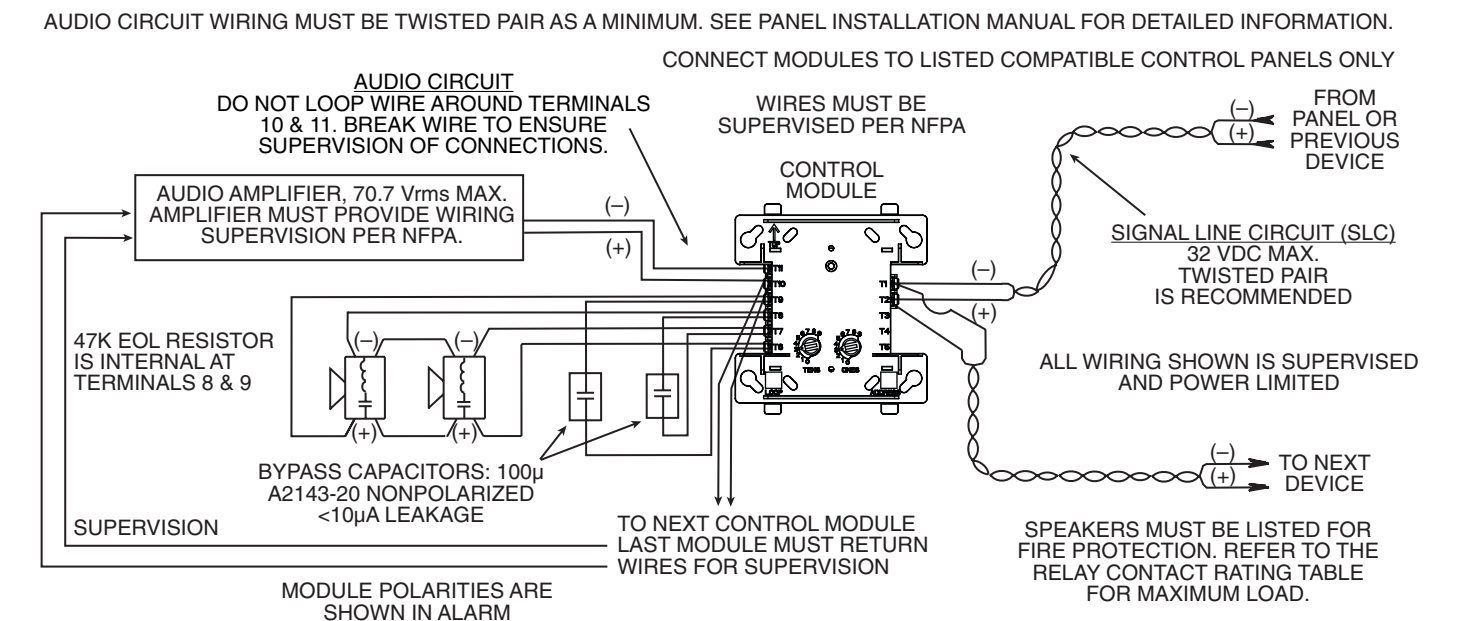

*NOTE: ANY FAULT IN THE POWER SUPPLY IS LIMITED TO THAT ZONE AND DOES NOT RESULT IN A FAULT IN A SEPARATE ZONE.

C0916-03