

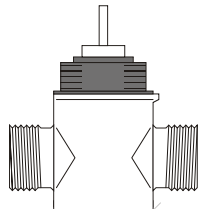
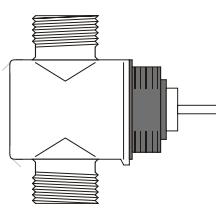
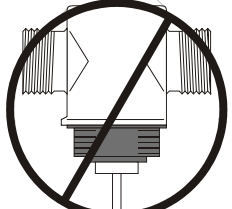
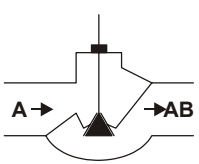
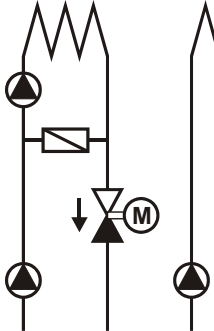
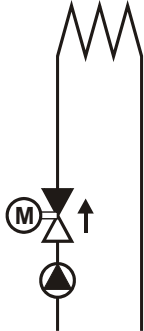
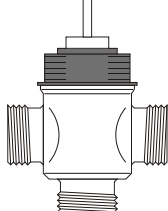
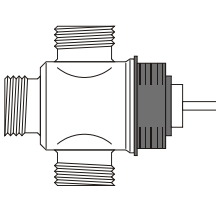
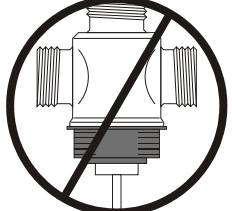
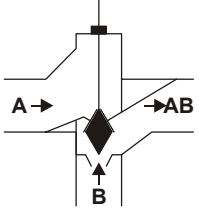
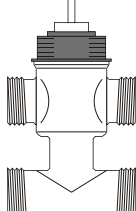
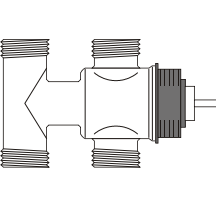
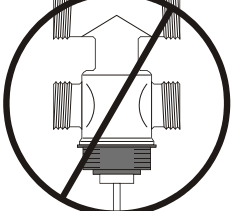
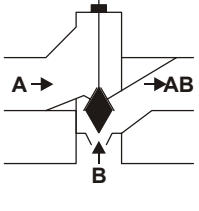
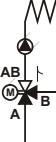

FI Asennusohje
 S Installation instruktioner
 N Installationsinstruktioner
 DK Installationsinstruktus
 NL Installatievoorschrift
 D Montageanweisung
 F Instructions d'installation
 ES Instrucciones de montaje
 I Istruzioni di montaggio

VSxC / VSxF 2-WAY / 3-WAY / 3-WAY VALVES WITH BYPASS

INSTALLATION INSTRUCTIONS

<p>PN 16 $\vartheta_{max.} 120\text{ }^{\circ}\text{C}$</p>					
	<p>Ventil im Rücklauf. Valve in the return. Vanne sur le retour. Ventil i returledning. Afsluiter in de retour. Valvola sul ritorno. Venttiili asennettuna paluujohtoon. Válvula sobre retorno. Ventil i returløb.</p>				<p>Ventil im Vorlauf. Valve in the flow. Vanne sur le départ. Ventil i framledning. Afsluiter in de aanvoer. Valvola sul mandata. Venttiili asennettuna menojohtoon. Válvula sobre impulsión. Ventil i fremløb.</p>
<p>PN 16 $\vartheta_{max.} 120\text{ }^{\circ}\text{C}$</p>					
<p>PN 16 + BYPASS $\vartheta_{max.} 120\text{ }^{\circ}\text{C}$</p>					
 <p>Beimischschaltung: Ventil als Mischer im Vorlauf. Mixing system: Valve as a mixer in the flow. Couplage en mélange: Vanne sur le départ montée en mélange.</p> <p>Blandningsventil i framledning. Mengschakeling: Afsluiter als mengorgaan in de aanvoer. Sistema a miscelazione: Valvola montata come miscelatrice sulla mandata. Sekoituskytkentä: Sekoitusventtiili menovedessä. Montaje como mezcladora: Válvula montada como mezcladora en la impulsión. Blandeventil i fremløb.</p>	 <p>Umlenkschaltung: Ventil als Mischer im Rücklauf. Diverting system: Valve as a mixer in return. Couplage en répartition: Vanne sur le retour montée en mélange.</p> <p>Blandningsventil i returledning. Mengschakeling: Afsluiter als mengorgaan in de retour. Sistema a deviazione: Valvola montata come miscelatrice sul ritorno. Ohituskytkentä: Sekoitusventtiili paluuviedessä. Montaje como diversora: Válvula montada como mezcladora en el retorno. Blandeventil i returløb.</p>	 <p>Einspritzschaltung: Ventil als Mischer im Rücklauf. Injection system: Valve as a mixer in return. Couplage en injection: Vanne sur le retour montée en mélange.</p> <p>Blandningsventil i returledning. Injektiv-mengschakeling: Afsluiter als mengorgaan in de retour. Sistema ad iniezione: Valvola montata come miscelatrice sul ritorno. Vakiokierto: Sekoitusventtiili paluuviedessä. Montaje inyección: Válvula montada como mezcladora en el retorno. Blandeventil i returløb med dobbeltshunt.</p>			

VSxC-2 / VSxF-2

D	EINBAU 1. Im Vorlauf oder im Rücklauf möglich. 2. Im Rücklauf vorziehen, da dort niedrigere Temperaturen herrschen. 3. Wenn vorhanden, nach Rohrleitungsplan einbauen und Durchflusszeichen auf dem Ventilgehäuse beachten: →	ES	MONTAJE 1. En impulsión o en retorno 2. Preferentemente, en el retorno, porque es menor la temperatura. 3. Mòntese según los esquemas Hidráulicos del proyecto; no obstante hay que respetar el sentido de flujo marcado sobre el cuerpo de la válvula: →
E	INSTALLATION 1. Either in the flow or the return pipework. 2. Preferably in the return due to the lower temperature conditions there. 3. If an installation plan is available, valve should be mounted at the location indicated. Note direction of flow indicated on the valve body: →	S	MONTERING 1. Ventilen är lämplig för montering i fram-och returledning. 2. Montering i returledning är att föredra på grund av där förekommande lägre temperatur. 3. Montera ventilen i enlighet med rörschemat om sådant finns tillgängligt men alltid under beaktande av flödessymbolen på ventilhuset: →
F	MONTAGE 1. Possible sur le départ ou sur le retour. 2. De préférence sur le retour car les températures y sont plus basses. 3. Monter selon le plan de raccordement hydraulique s'il existe; observer toutefois le sens d'écoulement marqué sur le corps de la vanne: →	SF	ASENNUS 1. Mahdollinen meno- tai paluujohtoon. 2. Suositellaan paluujohtoa, koska siellä alhaisempi lämpötila. 3. Asennus suoritetaan putkistokaavion mukaan. Aina on kuitenkin noudatettava venttiilin runkoon nuelella merkittyä läpivirtaussuuntaa: →
I	MONTAGGIO 1. Sulla mandata o sul ritorno. 2. E' preferibile il montaggio sul ritorno per la minore temperatura del fluido. 3. Effettuare il montaggio secondo lo schema impiantistico, rispettando le indicazioni esistenti sul corpo valvola: →	DK	MONTERING 1. Montering mulig i fremløb eller returløb. 2. Montering sker bedst i returløb, da temperaturene er lavere der. 3. Hvis der findes en rørplan, foretages montering i henhold til denne. Bemærk dog gennemstrømningspilen på ventilhuset: →
NL	MONTAGE 1. In annvoer of retour mogelijk. 2. Bij voorkeur in de retour omdat daar lagere temperaturen heersen. 3. Indien aanwezig, volgens leiding ontwerp, met inachtname van het op de afsluiter aanwezig zijnde stromingssteken: →		

VSxC-3 / VSxF-3, VSxC-4 / VSxF-4

D	EINBAU Wenn vorhanden, nach Rohrleitungsplan einbauen und Durchflusszeichen auf dem Ventilgehäuse beachten: A = Geregelter Teilstrom; AB = Gesamtstrom; B = Beipass-Teilstrom	ES	MONTAJE Mòntese según los esquemas hidráulicos del proyecto; no obstante hay que respetar los sentidos de flujo marcados sobre el cuerpo de la válvula: A = Caudal variable regulado; AB = Caudal total; B = Caudal variable de by-pass
E	INSTALLATION If an installation plan is available, valve should be mounted at the location indicated. The flow direction must always correspond with the symbol on the valve body: A = controlled port (variable); AB = total flow; B = bypass port (variable)	S	MONTERING Montera ventilen i enlighet med rörschemat, om sadant finns tillgängligt men alltid under beaktande av flödessymbolen på ventilhuset: A = reglerat delflöde; AB = totalflöde; B = förbigångsflöde
F	MONTAGE La vanne doit être montée à l'endroit indiquée dans le plan de raccordement hydraulique. Il faut respecter le sens de la flèche qui figure sur le corps de la vanne: A = débit variable réglé; AB = débit total du fluide; B = débit variable by-pass	SF	ASENNUS Venttiili tulisi asentaa putkistokaavion mukaan. Noudata venttiilin runkoon nuelella merkittyä läpivirtaussuuntaa: A = säädetty virtaus; AB = kokonaisvirtaus; B = ohitusvirtaus
I	MONTAGGIO Effettuare il montaggio secondo lo schema impiantistico, rispettando le indicazioni esistenti sul corpo valvola: A = via diretta; AB = portata totale (via sempre aperta); B = via di by-pass	DK	MONTERING Hvis der findes en rørplan, foretages montering i henhold til denne. Bemærk dog gennemstrømningspilen på ventilhuset: A = Tilgang; AB = Femløb; B = Shunttilslutning
NL	MONTAGE Installeren volgens leidingschema (indien voorhanden) en rekening houden met de doorstroompijl op het kleppenhuus: A = Geregeld gedeelte; AB = Gezamelijke stroom; B = Bypass gedeelte		

DIMENSIONS

***NOTE:** In the case of modulating valves, the stroke amounts to 6.5 mm, and the closure distance to 18 mm. In the case of ON/OFF valves, the stroke amounts to 2.5 mm, and the closure distance to 14 mm.

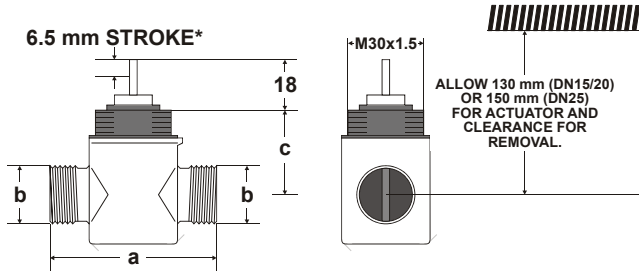

Fig. 1. VSxC-2 / VSxF-2 (2-way), dimensions

Table 1. VSxC-2 (2-way), dimensions (in mm)

	a	b	c
DN15	56	G ½ A†	32
DN20	66	1-1/8 BS84	34
DN25	76	G 1 ¼ A†	48

† ISO 228/1

Table 2. VSxF-2 (2-way), dimensions (in mm)

	a	b	c
DN15	56	G ½ A†	32
DN20	66	G ¾ A†	34
DN25	76	G 1 ¼ A†	48

† ISO 228/1

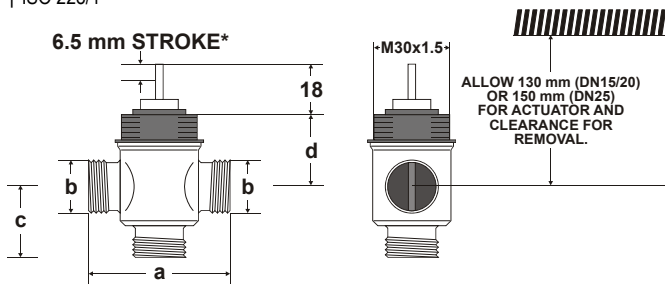

Fig. 2. VSxC-3 / VSxF-3 (3-way), dimensions

Table 3. VSxC-3 (3-way), dimensions (in mm)

	a	b	c	d
DN15	56	G ½ A†	24.5	32
DN20	66	1-1/8 BS84	33	34
DN25	76	G 1 ¼ A†	38	48

† ISO 228/1

Table 4. VSxF-3 (3-way), dimensions (in mm)

	a	b	c	d
DN15	56	G ½ A†	25.5	32
DN20	66	G ¾ A†	33	34
DN25	76	G 1 ¼ A†	38	48

† ISO 228/1

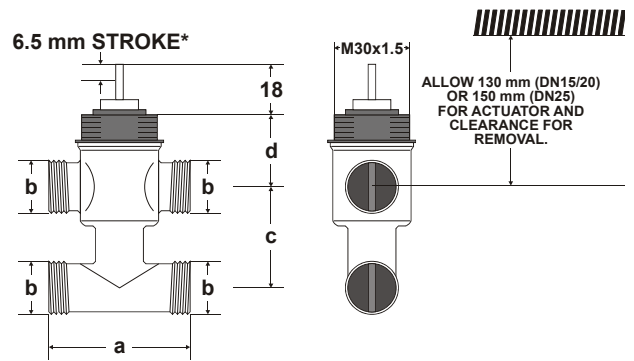

Fig. 3. VSxC-4 / VSxF-4 (3-way with bypass), dimensions

Table 5. VSxC-4 (3-way with bypass), dimensions (in mm)

	a	b	c	d
DN15	56	G ½ A†	40	32
DN20	66	1-1/8 BS84	40	34
DN25	76	G 1 ¼ A†	62.5	48

† ISO 228/1

Table 6. VSxF-4 (3-way with bypass), dimensions (in mm)

	a	b	c	d
DN15	56	G ½ A†	40	32
DN20	66	G ¾ A†	40	34
DN25	76	G 1 ¼ A†	62.5	48

† ISO 228/1

DIMENSIONS WITH SNAP-ON

In the case of models featuring a snap-on ring, the actuator can be directly attached to the valve without having to first mount a ring.

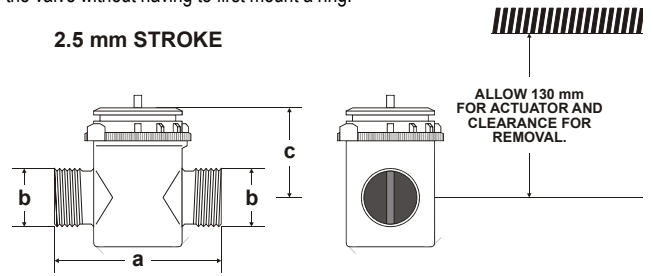

Fig. 4. VSxC-2 / VSxF-2 (2-way with snap-on), dimensions

Table 7. VSxC-2 / VSxF-2 (2-way with snap-on), dimensions (mm)

	a	b	c
DN15	56	G ½ A†	34.5
DN20 (VSxC-2)	66	1-1/8 BS84	36.6
DN20 (VSxF-2)	66	G ¾ A†	36.6

† ISO 228/1

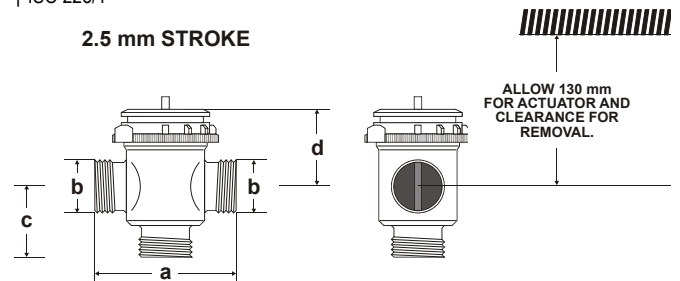

Fig. 5. VSxC-3 / VSxF-3 (3-way with snap-on), dimensions

Table 8. VSxC-3 / VSxF-3 (3-way with snap-on), dimensions (mm)

	a	b	c	d
DN15	56	G ½ A†	24.5	34.5
DN20 (VSxC-3)	66	1-1/8 BS84	33	36.6
DN20 (VSxF-3)	66	G ¾ A†	33	36.6

† ISO 228/1

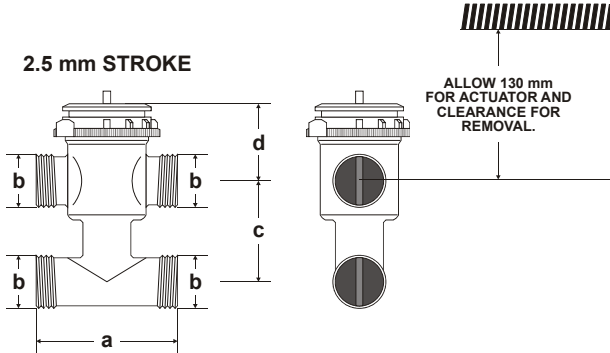

Fig. 6. VSxC-4 / VSxF-4 (3-way with bypass + snap-on), dimensions

Table 9. VSxC-4 / VSxF-4 (3-way with bypass + snap-on), dimensions (in mm)

	a	b	c	d
DN15	56	G ½ A†	40	34.5
DN20 (VSxC-3)	66	1-1/8 BS84	40	36.6
DN20 (VSxF-3)	66	G ¾ A†	40	36.6

† ISO 228/1

ACCESSORIES

VSxF Valves

	DN	type
	15 20	AC-15 FS AC-20 FS
	15 20 25	AC-15 FT AC-20 FT ACS-25 T

type	b	e	g
AC-15 FS	G ½	12	-
AC-15 FT	G ½	-	R 3/8"
AC-20 FS	G ¾	15	-
AC-20 FT	G ¾	-	R ½"
ACS-25 T	G 1 ¼	--	R 1"

VSxC Valves

ISO 7/1	DN	type
	15 20	ACN-15 C ACN-20 C
	15 20	ACN-15 S ACN-20 S
	15 20 25	ACN-15 T ACN-20 T ACN-25 T
Conex fitting (not available from Honeywell)	15 20	63 (15 mm) 65 (15 mm) 63 (22 mm) 65 (22 mm)

type	b	e	f	g
ACN-15 C	G ½	15 mm	-	-
ACN-15 S	G ½	-	12 mm	-
ACN-15 T	G ½	-	-	R 3/8"
ACN-20 C	1-1/8 x 14 BS 84	22 mm	-	-
ACN-20 S	1-1/8 x 14 BS 84	-	15 mm	-
ACN-20 T	1-1/8 x 14 BS 84	--	-	R ½"
ACN-25 T	G 1 ¼	--	--	R 1"

Honeywell

Manufactured for and on behalf of the Environmental and Combustion Controls Division of Honeywell Technologies Sàrl, Rolle, Z.A. La Pièce 16, Switzerland by its Authorized Representative:

Automation and Control Solutions

Honeywell GmbH

Böblinger Strasse 17

71101 Schönaich

Germany

Phone: (49) 7031 63701

Fax: (49) 7031 637493

<http://ecc.emea.honeywell.com>

Subject to change without notice. Printed in Germany

MU1B-0404GE51 R0209 / EB-VSM-VSO Rev. B