

### TABLE OF CONTENTS

<b>Safety Information</b> .....	<b>2</b>
General Safety Information .....	2
Construction .....	2
Mounting Method .....	2
WEEE Directive .....	2
<b>End User License Agreement</b> .....	<b>2</b>
<b>Model Description</b> .....	<b>2</b>
HAWK 8000 .....	2
Included in Shipment .....	2
<b>Overview of Features</b> .....	<b>3</b>
Materials and Tools Required .....	4
<b>Preparation</b> .....	<b>4</b>
<b>Mounting</b> .....	<b>4</b>
Environmental Requirements .....	4
Dimensions, Tab Mounting .....	4
Mounting on a DIN Rail .....	5
Wiring .....	5
Bus and Port Connections .....	6
<b>Order Numbers</b> .....	<b>11</b>
<b>Drivers</b> .....	<b>11</b>
Included Drivers .....	11
Optional Drivers .....	11
<b>Specifications</b> .....	<b>12</b>
Power .....	12
Environmental Specifications .....	12
<b>Approvals, Certifications, etc.</b> .....	<b>12</b>
<b>Related Technical Literature</b> .....	<b>12</b>

#### Trademark Information

LON, LONWORKS, and Neuron are trademarks of Echelon Corporation registered in the United States and other countries.

## SAFETY INFORMATION

### General Safety Information

- ▶ When performing any work, all instructions given by the manufacturer and in particular the safety instructions provided in these Installation and Commissioning Instructions are to be observed. Make sure that the local standards and regulations are observed at all times.
- ▶ The HAWK 8000 System (including the HAWK 8000 Controller, Panel Bus I/O modules, expansion modules, etc.) may be installed and mounted only by authorized and trained personnel.
- ▶ If the controller housing is damaged or missing, immediately disconnect it from any power.
- ▶ If the device is broken or defective, do not attempt to repair it yourself; rather, return it to the manufacturer.
- ▶ It is recommended that devices be kept at room temperature for at least 24 hours before applying power. This is to allow any condensation resulting from low shipping / storage temperatures to evaporate.
- ▶ The HAWK 8000 System must be installed in such a manner (e.g., in a lockable cabinet) as to ensure that uncertified persons have no access to the terminals.
- ▶ If the HAWK 8000 System is modified in any way, except by the manufacturer, all warranties concerning operation and safety are invalidated.
- ▶ Rules regarding electrostatic discharge should be followed.
- ▶ Use only accessory equipment which comes from or has been approved by Honeywell.

### Construction

The HAWK 8000 Controller is an independently mounted electronic control unit with fixed wiring.

### Mounting Method

The HAWK 8000 Controller is suitable for mounting as follows:

- ▶ in cabinets;
- ▶ in fuse boxes conforming with standard DIN43880, and having a slot height of max. 45 mm;
- ▶ in cabinet front doors;
- ▶ on walls.

### WEEE Directive

<b>WEEE: Waste Electrical and Electronic Equipment Directive</b>	
	<ul style="list-style-type: none"> <li>▪ At the end of the product life, dispose of the packaging and product in an appropriate recycling center.</li> <li>▪ Do not dispose of the device with the usual domestic refuse.</li> <li>▪ Do not burn the device.</li> </ul>

### END USER LICENSE AGREEMENT

See End User License Agreement (EULA) at [www.tridium.com/en/resources/library](http://www.tridium.com/en/resources/library).

### MODEL DESCRIPTION

#### HAWK 8000

DIN-mounted, 24 VAC/DC (50/60 Hz) powered, Niagara® controller. See the HAWK 8000 – Product Data (Product Literature No.: EN0Z-1016GE51) for complete specifications.

#### Included in Shipment

This package includes the following items:

- The HAWK 8000 Niagara® controller;
- A microSD flash memory card in plastic case. See section "Preparation" on pg. 4;
- Coax-mounted, dual 2.4/5.8 GHz antenna for a wireless local area network (WLAN), two 3-position RS485 connector plugs, one 2-position power connector, and a grounding wire;
- The HAWK 8000 Controller – Mounting Instructions (Product Literature No.: MU1Z-1016GE51).

## OVERVIEW OF FEATURES

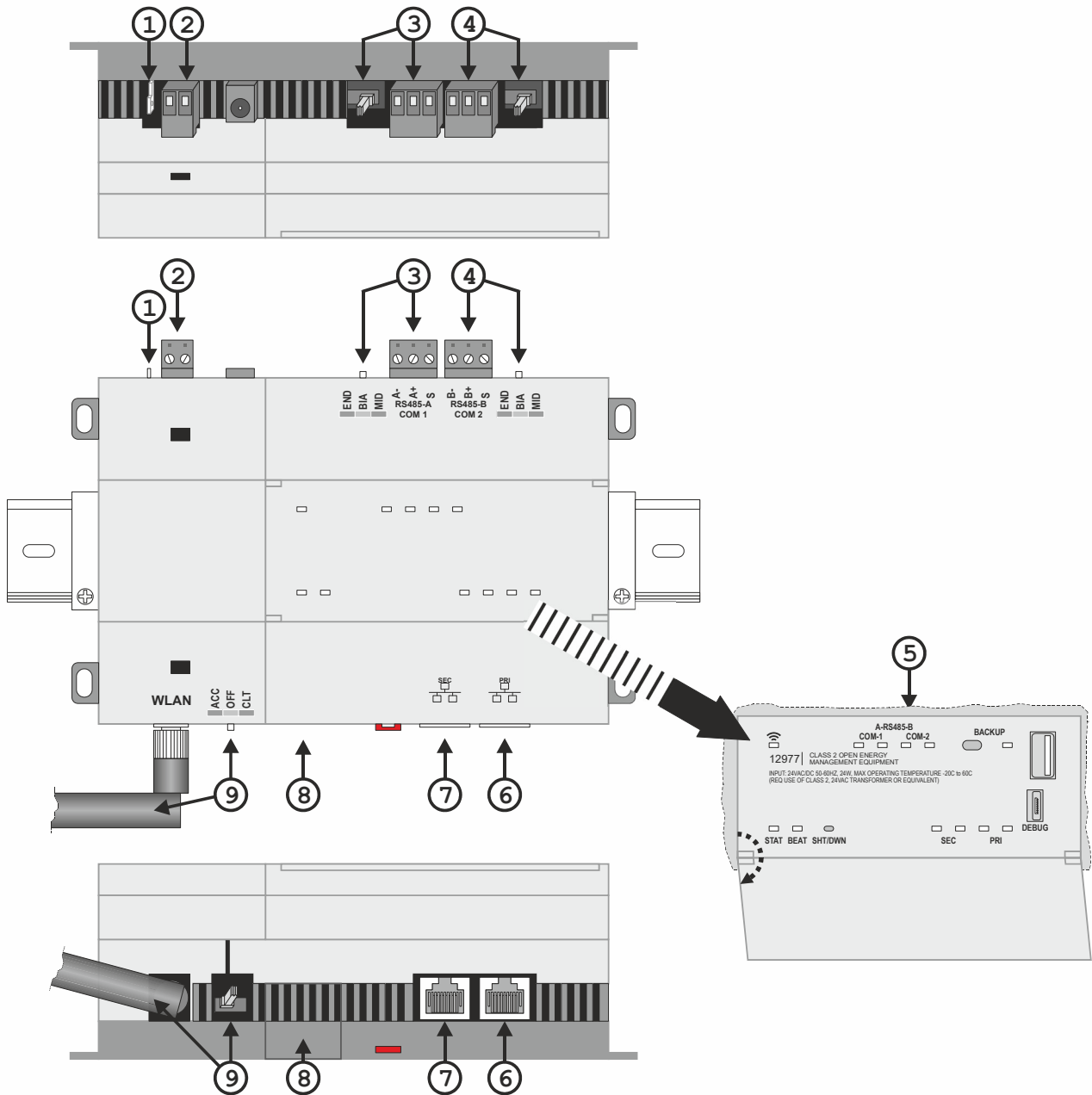

Fig. 1. HAWK 8000, overview of features

1	Earth ground	6	PRI (primary) LAN1, 10/100-Mbit Ethernet connection
2	Terminal block for 24 VAC/DC power supply	7	SEC (secondary) LAN2, 10/100-Mbit Ethernet connection
3	RS485-A port and bias / termination switch	8	Access shutter for microSD card (slide to open / close)
4	RS485-B port and bias / termination switch	9	WiFi settings switch and WiFi antenna
5	LEDs and (when door open) USB 2.0 and Micro-A USB		

## Materials and Tools Required

- One of the following:
  - UL-listed, Class 2, 24 VAC transformer, rated at a minimum of 24 VA. A dedicated transformer is required (must not be used to power additional equipment), or
  - UL-listed, Class 2 or LPS 24 VDC power supply, capable of supplying at least 1 A (24 W), or
- DIN rail, type NS35/7.5 (35 mm X 7.5 mm) and DIN rail-clips (stop clips), recommended for any installation that includes option modules. The HAWK 8000 is also panel-mountable.
- Suitable tools and fasteners for mounting the unit and any accessories.

## PREPARATION

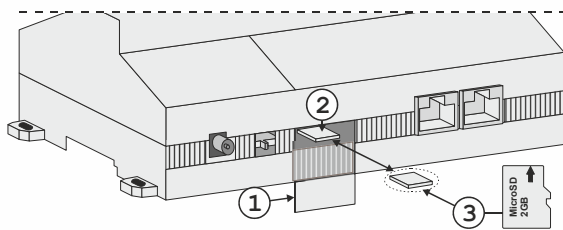

**Fig. 2. Removal of microSD flash memory card**

### Legend

1. Access shutter for microSD flash memory card
2. Card carrier inside controller
3. The microSD flash memory card to insert or remove from card carrier. Insert card with the label pointing upwards, until the spring catch latches. If properly inserted, the card is behind the shutter track. To remove the card, push and release the card.

Before mounting a new controller, you must first insert the microSD flash memory card (included in the delivery).

**NOTE:** The microSD flash memory card has the controller's unique, factory-set Niagara identity (host ID). The data on the card is encrypted by a special "system password" stored in the controller base software. If you swap in a card from a previously configured unit, you must re-enter this same password using a serial connection to the controller's Debug port.



## WARNING

### Risk of electric shock or equipment damage!

- ▶ Disconnect the power supply before removing or inserting the microSD flash memory card. Failure to do so is likely to damage the equipment.

## MOUNTING

Mount the HAWK 8000 in a location that allows clearance for wiring, servicing, the antenna, and module removal.

## Environmental Requirements

**NOTE:** This product is for indoor use, only, below an altitude of 2,000 meters (6,562 feet) above sea-level.

Ambient conditions must be within a range of:

- Operating temperature: -20 ... +60 °C (-4 ... +140 °F).  
Storage temperature: -40 ... +85 °C (-40 ... +185 °F).
- Relative humidity: 5 ... 95%, non-condensing.
- Supply (mains) voltage requirements are:
  - Allowable voltage fluctuation to ±10%.

**NOTE:** Horizontal mounting is strongly recommended. This is to achieve maximum heat dissipation and comply with the operating temperature upper limit. Any other mounting orientation reduces this upper limit.

## Dimensions, Tab Mounting

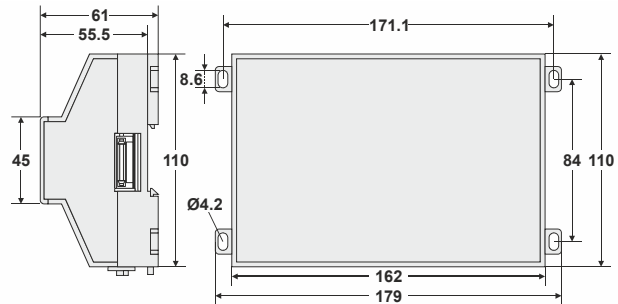

**Fig. 3. HAWK 8000, dimensions (in mm)**

**NOTE:** Allow at least 38 mm clearance around all sides and a minimum 76 mm at the bottom for the WiFi antenna.

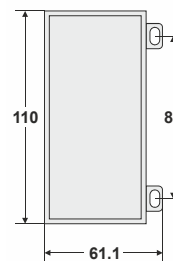

**Fig. 4. Expansion module, dimensions (in mm)**

**NOTE:** Up to four expansion modules may be used. (Separate limits may exist in the controller's license which may further limit options.)

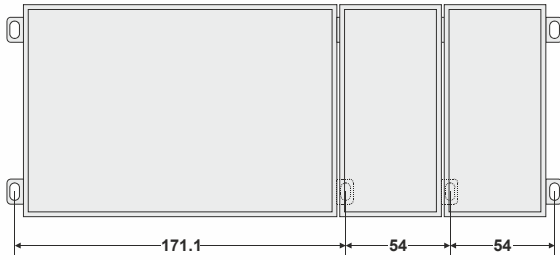

Fig. 5. Distances between center of tabs (in mm)

DIN rail mounting is recommended. Where tab mounting is required, use the dimensions in Fig. 3, Fig. 4, and Fig. 5 to mount the controller and up to four Expansion Modules.

**WARNING**

**Risk of equipment damage!**

- ▶ Do not mount hardware on both a DIN rail and with tab mounts to another surface insofar as this would cause physical stress on the equipment and prevent good connections between the controller and the Expansion Modules.

**Mounting on a DIN Rail**

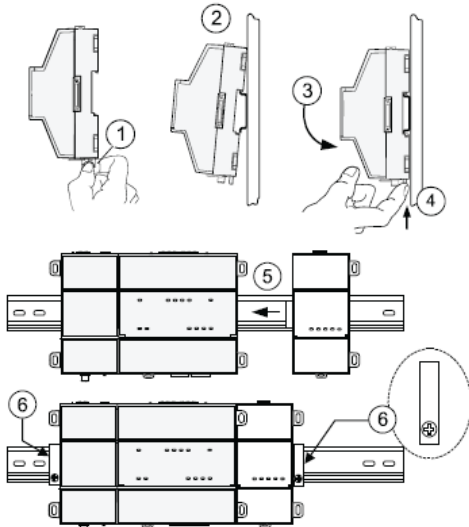

Fig. 6. Mounting on DIN rail

1. Pull the controller's locking clip downwards.
2. Tilt the controller to hook over the DIN rail.
3. Push down and in on the unit, fastening to the rail.
4. Push the locking clip up snug against the controller to secure.
5. Mount any Expansion Module onto the DIN rail in the same way. Slide the module firmly into the controller's connector to seat. Repeat for other modules as needed

(max. of four Expansion Modules permitted – depending upon combination).

6. Carefully secure both ends of the final assembly with DIN rail end-clips provided by the DIN rail vendor.

**Wiring**

**WARNING**

**Risk of electric shock or equipment damage!**

- ▶ Before making power terminations, de-energize the 24V power source. Do not restore power until completing all other mounting and wiring. See also section "Power Up and Initial Checkout" on pg. 8.

**Wiring Earth Ground and Power**

Earth grounding (see "A" in Fig. 7) provides protection against electrostatic discharge or other forms of EMI.

- NOTE:** Depending upon the power source used (see Fig. 7):
- B1:** For AC power: Dedicated 24V transformer required, with neither side of the transformer secondary tied to the ground.
  - B2:** For DC power: Polarity is unimportant (uses onboard diode bridge), with neither leg tied to the ground.

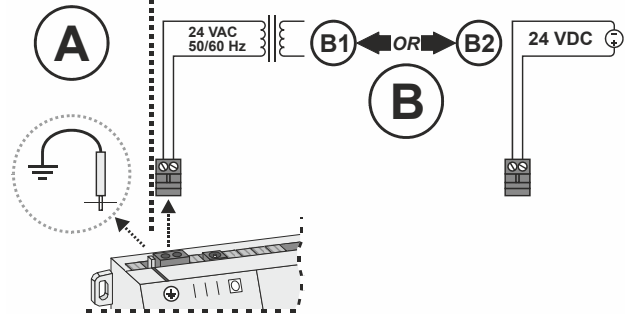

Fig. 7. Earth ground and power options

**Prerequisite:** A nearby earth grounding point.

- A. Install the included earth ground wire to the controller's earth ground spade lug and terminate the other end to a nearby earth ground.
- B. Unplug the controller's 2-position power connector plug and terminate the 24V supply source (AC or DC) to the connector. Leave the connector unplugged for now.

**Communications Wiring**

Field communication ports are as follows:

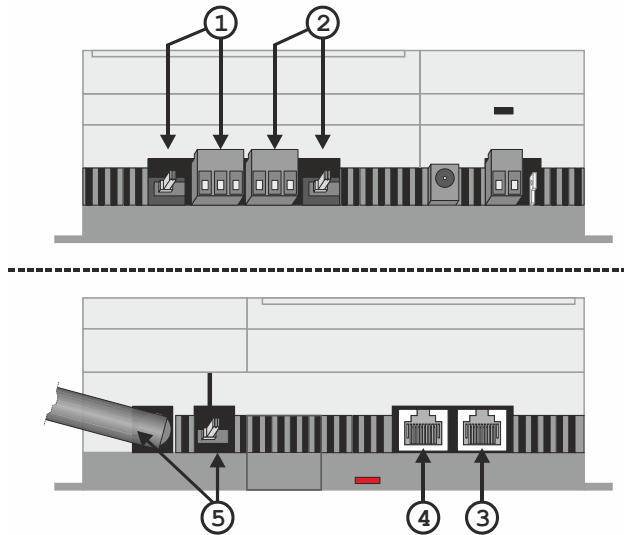

Fig. 8. Communication ports

**Legend**

1. RS485-B port and bias / termination switch
2. RS485-A port and bias / termination switch
3. PRI (primary) LAN1, 10/100-Mbit Ethernet connection (RJ45)
4. SEC (secondary) LAN2, 10/100-Mbit Ethernet connection (RJ45)
5. WiFi settings switch and WiFi antenna

**WiFi**

The HAWK 8000 is equipped with an integrated WiFi adapter (see Fig. 9) providing wireless connectivity using the IEEE 802.11a/b/g/n standard. The RP-SMA antenna connector is for the connection of the tilt-and-swivel 2.4 GHz antenna included in the shipment.

**WiFi Configuration Switch**

Adjacent to the WiFi antenna is a 3-position configuration switch, with the following settings:

- OFF** (Default, middle position) WiFi adapter is disabled.
- ACC** (Left position) Controller provides operation as a WiFi access point for up to 20 clients.
- CLT** (Right position) Controller operates as a client to an existing 802.11a/b/g/n router or access point.

To use, either screw in the antenna directly (see Fig. 9) or use an optional coax cable extension kit (CBL-WIFI-EXT) to locate the antenna up to 2 m away. An associated LED remains lit whenever the WiFi is enabled.

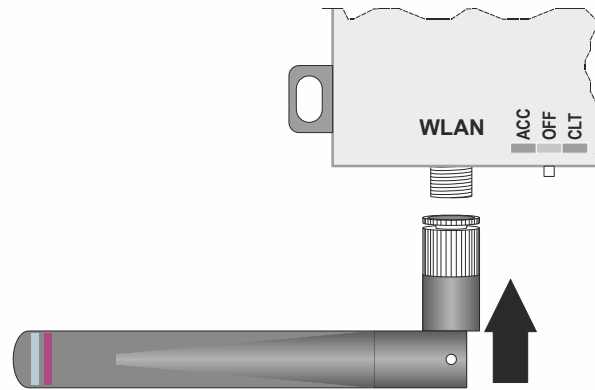

Fig. 9. Attachment of WiFi antenna

Refer to the HAWK 8000 – Installation & Startup Guide (EN1Z-1027GE51) for details on WLAN configuration and factory-default IP settings.

**Bus and Port Connections**

**Overview**

Table 1. Overview of bus interfaces

description		max. cable length	no.
RS485-A and RS485-B, isolated: BACnet MS/TP, Panel Bus, or Modbus RTU Master or Slave communication		*1200 m	2
Ethernet / RJ45 socket	SEC: e-mail communication, browser access	100 m	2
	PRI: IP communication	100 m	
WiFi antenna		--	1

\*Depending upon baud rate (see Table 2).

**WARNING**

**Risk of electric shock or equipment damage!**

- ▶ Do not touch any live parts in the cabinet!
- ▶ Disconnect the power supply before inserting or removing the microSD flash memory card, making connections to or removing connections from terminals of the HAWK 8000 Controller, Expansion Modules, or Panel Bus I/O modules.
- ▶ Do not reconnect the power supply until you have completed installation.
- ▶ It is prohibited to power the HAWK 8000 Controller with the same transformer used to power other controllers or devices (e.g., the PW M-Bus Adapter).
- ▶ Observe the rules regarding electrostatic discharge.
- ▶ Removal of the controller's cover is not required. No configurable or user-serviceable items (e.g., jumpers or battery) require cover removal.
- ▶ To reduce the risk of fire or electrical shock, install the device in a controlled environment relatively free of contaminants.
- ▶ To comply with FCC and Industry Canada RF exposure limits for general population / uncontrolled exposure, the antenna(s) used for this transmitter must be installed to provide a separation distance of at least 20 cm from all persons and must not be co-located or operating in conjunction with any other antenna or transmitter.

**RS485 Wiring**

The HAWK 8000 is equipped with two RS485 ports operating as COM1 and COM2. Each port is capable of up to 115,200 baud, and uses a 3-position, screw terminal connector.

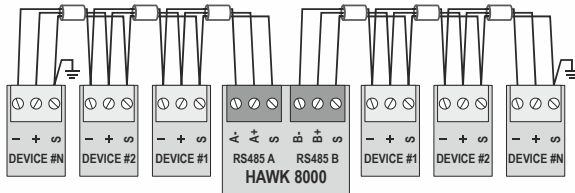

**Fig. 10. RS485 wiring example**

**NOTE:** RS485 devices on the same network should use the same communication protocol and the same baud rate. Up to 32 or more devices may be supported, depending upon device specifications.

Use shielded, twisted-pair, 18-22 AWG cabling to wire in a continuous daisy-chain fashion to the RS485 ports of other devices: "minus to minus," "plus to plus," and "shield to shield."

Connect the shield wire to earth ground at one end, only. Fig. 10 shows example wiring.

**RS485 Ports and Bias / Termination Switches**

Each of the two RS485 ports of the HAWK 8000 (see Fig. 8) has an adjacent 3-position biasing switch, with the following settings:

- BIA** (Default, middle position) RS485 biasing; 2.7 kΩ bias resistors with no termination resistor.
- END** (Left position) RS485 biasing and termination; 562 Ω bias resistors and 150 Ω termination resistor.
- MID** (Right position) no RS485 biasing; 47.5 kΩ bias resistors with no termination resistor.

Adding RS485 biasing can often improve communications by eliminating indeterminate idle states.

Each RS485 port has two LEDs. See also Fig. 14 on pg. 9. In Fig. 11, Fig. 12, and Fig. 13, the internal wiring for RS485-A is presented as an example. The RS485-B port has the same internal wiring.

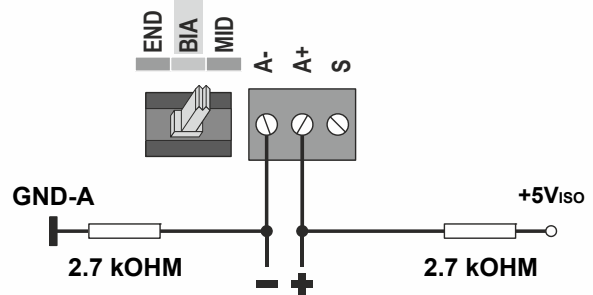

**Fig. 11. RS485-A 3-position bias switch set to BIAS (default)**

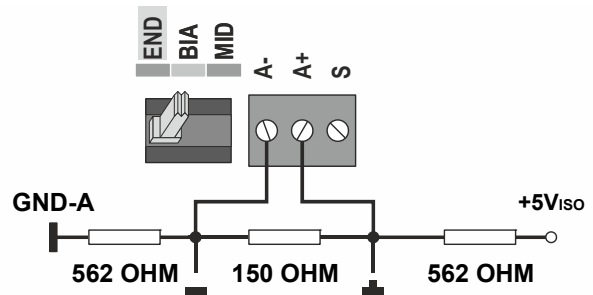

**Fig. 12. RS485-A 3-position bias switch set to END**

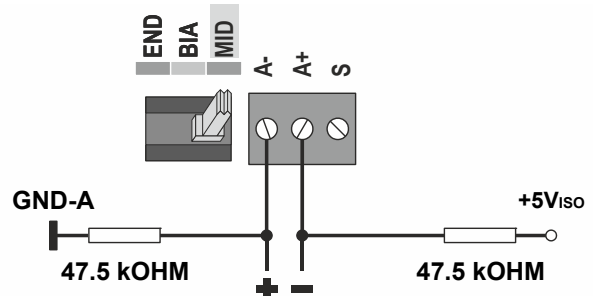

**Fig. 13. RS485-A 3-position bias switch set to MID**

The recommended bias switch setting depends upon the location and usage of the given HAWK 8000. It also depends upon the selected communication protocol (BACnet MS/TP,

Panel Bus, or Modbus RTU Master communication, respectively).

**NOTE:** All terminals are protected (up to 24 Vac) against short-circuiting and incorrect wiring – except when the 3-position bias switch is set to "END," in which case the terminals of the RS485 bus have no such protection. Higher voltages may damage the device.

**NOTE:** According to BACnet standards, a min. of one and a max. of two BACnet devices must have its/their bias resistors switched ON. In the case of the RS485 ports of the HAWK 8000, setting the bias switch to either "BIAS" or "END" fulfills this requirement.

**RS485 Standard**

According to the RS485 standard (TIA/EIA-485: "Electrical Characteristics of Generators and Receivers for Use in Balanced Digital Multipoint Systems"), only one driver communicating via an RS485 port may transmit data at a time. Further, according to U.L. requirements, each RS485 port may be loaded with a max. of 32 unit loads. E.g., CentralLine devices have as little as ¼ unit load each, so that up to 128 devices can be connected.

BACnet MS/TP connections to the RS485 ports must comply with the aforementioned RS485 standard. Thus, it is recommended that each end of every connection be equipped with one termination resistor having a resistance equal to the cable impedance (120 Ω / 0.25 – 0.5 W).

RS485 systems frequently lack a separate signal ground wire. However, the laws of physics still require that a solid ground connection be provided for in order to ensure error-free communication between drivers and receivers – unless all of the devices are electrically isolated and no earth grounding exists.

**IMPORTANT**

*In the case of new HAWK 8000 controller installations, we strongly recommend using a separate signal ground wire. Doing otherwise may possibly lead to unpredictable behavior if other electrically non-isolated devices are connected and the potential difference is too high.*

*In the case of the installation of HAWK 8000 controllers in already-existent RS485 two-wire systems (e.g., when replacing PANTHER or LION controllers with HAWK 8000 controllers), not using a separate signal ground wire will probably have no undesirable effects.*

The cable length affects the baud rate. The following table provides a few examples.

**Table 2. Baud rate vs. max. cable length for RS485**

Baud rate	Max. cable length (L)
9.6 - 76.8 kbps	1200 m
115.2 kbps	1000 m

For information on wire gauge, max. permissible cable length, possible shielding and grounding requirements, and the max. number of devices which can be connected to a bus, refer to standard EIA-485.

**Ethernet Wiring**

The HAWK 8000 is equipped with two RJ45 10/100-Mbit Ethernet ports (see Fig. 8). They are labelled PRI (LAN1) for primary and SEC (LAN2) for secondary. Each port is capable of up to 100 mbits/sec baud, and uses a standard Ethernet patch cable for connection to an Ethernet switch.

 **WARNING**

**Risk of electric shock or equipment damage!**

- ▶ It is prohibited to connect any of the RJ45 sockets of the HAWK 8000 Controller to a so-called PoE-enabled device ("Power over Ethernet").

The factory default IP address for PRI is 192.168.1.140. The subnet mask is 255.255.255.0. By default, SEC (LAN2) is disabled.

Please see HAWK 8000 – Installation & Startup Guide (EN1Z-1027GE51) for details on the software configuration of the Ethernet ports.

**NOTE:** Unless you have a specific application for SEC (LAN2) – e.g., when using it to isolate a driver's network traffic – generally only PRI (LAN1) is used. If you wish to enable SEC, note that PRI and SEC must be connected to different IP subnets. Further, HAWK 8000 does not provide IP routing or bridging operation between two Ethernet ports.

**Power Up and Initial Checkout**

Apply power by inserting the 2-position 24V power connector plug. See also Fig. 7.

Check the STAT (status) and BEAT (heartbeat) LEDs (Fig. 14).

When power is applied, the green STAT LED will light. This indicates that the system is OK, with power applied. During bootup, the BEAT LED may flash at 1 Hz with a 90% ON, 10% OFF duty cycle. When bootup completes, the platform daemon is started, and the normal 1 Hz flash (50% ON, 50% OFF) duty cycle of the BEAT LED returns.

**STATUS LEDs**

The HAWK 8000 provides a number of status LEDs, with all but one visible with the front access door closed (see Fig. 14):



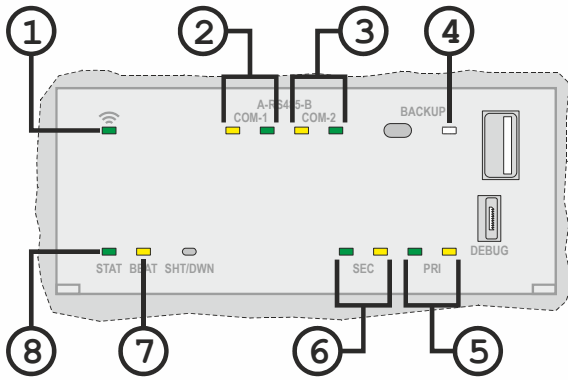

Fig. 14. HAWK 8000 Controller LEDs (shown here with access door open)

**Legend**

1. WiFi (green): Lit whenever WiFi configuration switch is not OFF.
2. RS485-A (COM1): Transmit (Tx, yellow) and Receive (Rx, green).
3. RS485-B (COM2): Transmit (Tx, yellow) and Receive (Rx, green).
4. BACKUP (green; visible only when access door is open): Typically OFF.
5. PRI: Primary Ethernet (LAN1): "Link" (green), "Activity" (yellow).
6. SEC: Secondary Ethernet (LAN2): "Link" (green), "Activity" (yellow).
7. BEAT (yellow): "Heartbeat" LED flashing at 1 Hz during normal operation.
8. STAT (green): Remains lit.

**RS485 LEDs**

RS485 port A (COM1) and RS485 port B (COM2) each have two LEDs indicating port activity as follows:

**Tx** Yellow. Indicates that the controller is transmitting data on the RS485 port.

**Rx** Green. Indicates that the controller is receiving data from an RS485 device connected to this port.

These LEDs use a fixed "ON time" when a message is detected on the port. If a receive LED is ON constantly, this can indicate a wiring problem (e.g., a shorted wire or reversed wiring).

**STAT (Status) LED**

The green "STAT" LED provides a CPU machine status check, and should remain lit whenever the controller is ON. If the status LED does not light while power is applied, contact T.A.C. for technical support.

**BEAT (Heartbeat) LED**

During normal operation, the yellow heartbeat "BEAT" LED flashes at 1 Hz, in a 50% / 50% ON/OFF duty cycle. During controller boot-up, this LED may flash at 1 Hz with a 90% / 10% ON/OFF duty cycle, or in some other irregular pattern. When boot-up completes, the platform daemon is started, and the normal 1 Hz flash at 50% / 50% ON/OFF duty cycle returns.

**! CAUTION**

The 1 Hz, 90% / 10% ON/OFF "BEAT" flash at boot-up also occurs during other critical operations, such as a firmware upgrade to the controller and/or any attached modules. To be safe, do not remove power from the controller while its "BEAT" LED is flashing in a 90% / 10% ON/OFF duty cycle. Instead, wait for the normal (50% / 50%) flash to return before removing power.

If the "BEAT" LED remains ON constantly, does not light up, or flashes very fast, contact T.A.C. for technical support.

**PRI, SEC (Ethernet) LEDs**

Two LEDs for each of the two LAN ports indicate as follows:

**Link:** The green (left side) "Link" LED operates as follows.

- OFF: No Ethernet link has been established.
- ON: Ethernet link has not been established.

**Activity:** The yellow (right side) "Activity" LED operates as follows:

- OFF: No Ethernet activity.
- ON: Flashing indicates activity (typical if Link is ON).

**BACKUP LED**

A green "BACKUP" LED is located behind the front access door, and is visible only when the door is open. Typically, this LED is OFF.

Possible "BACKUP" LED states are as follows:

- ON constantly: USB backup media detected. Occurs when you insert a USB flash drive, to signal that a backup is possible.
- Alert mode: 100 ms ON / 100 ms OFF repeating (fast flashing). Occurs for several seconds in the following scenarios:
  - When USB media was detected, after the controller's BACKUP button has been pressed (backup mode).
  - When the controller is power-cycled while holding down the BACKUP button (recovery / restore mode).
- Working mode: 1 second ON / 1 second OFF repeating (slow flashing). Never remove power in this mode. See WARNING.
- Error mode: Two quick 200 ms flashes ON, 3 seconds OFF, repeating.

**BACKUP LED Scenarios**

Some scenarios where the BACKUP LED is used include:

**USB drive inserted:** A USB flash drive is inserted in the USB 2.0 port, to either backup a commissioned unit to the USB drive, or to restore an existing backup from the drive. The BACKUP LED lights up when the USB drive is mounted.

**Backup:** A backup is initiated by pressing the BACKUP button from 1 to 5 seconds before releasing it. The BACKUP LED will then start flashing in the "Alert Mode" for 5 seconds. Another button press during this period will start the backup, during which time the LED will flash in the "Working Mode" pattern. When the backup completes, the LED will become dark, and the USB drive can then be removed.

**Boot to recover or restore image:** The unit is powered up while holding down the BACKUP button, for either:

- (No USB media detected): A "factory defaults" recovery from an onboard partition with the default image.
- (If USB media is detected): For the restoration of a backup image on the USB flash drive. NOTE that this also requires a serial shell connection to the controller's Debug port.

In either case, the BACKUP LED will start flashing in the "Alert Mode" pattern. If you then release the BACKUP button during this period (within 5 seconds), initiation begins for either:

- If no USB media is detected, the "factory defaults" recovery image installation.
- If USB media is detected, the system enters the "restore mode." In this mode, after log-in with serial shell, a menu will list the available backup images on the USB flash drive. You can select one (and enter the unique security key to initiate its installation), or alternately select to install the "factory defaults" recovery image.

During a recovery or restore image installation, the LED flashes in the "working mode" pattern. When the image installation completes, the BACKUP LED turns OFF. A controller reboot is then required.

See also the HAWK 8000 Backup and Restore Guide (EN2Z-1027GE51) for complete details.

## ⚠ CAUTION

Do not remove power while a recovery image install or backup restore is in progress, i.e., when the BACKUP LED is flashing in the "working mode" pattern (1 sec ON / 1 sec OFF, or slow flash). Otherwise, the controller will be inoperable ("bricked"), and must be returned to a service center for repair.

### USB Ports and Pushbuttons

Behind the controller's front access door, there are two USB ports, two pushbuttons, and an associated LED.

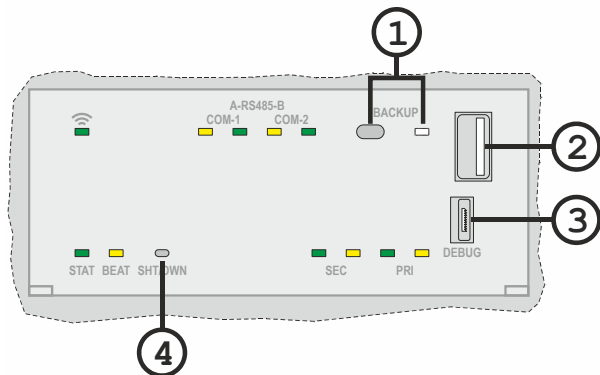

**Fig. 15. HAWK 8000 Controller USB ports and pushbuttons (shown here with access door opened)**

#### Legend

1. BACKUP button and corresponding BACKUP LED.
2. PROG: USB 2.0 for use with USB flash (thumb) drive.
3. DEBUG: Micro-A USB for serial debugging communications.
4. SHT/DWN: Recessed pushbutton for initiating a controlled shutdown.

The DEBUG port is a standard Micro-A type USB port for serial debugging communications to the controller. You can use a serial terminal program (for example: PuTTY) to access the controller's "system shell" menu. This provides access to a few basic platform settings.

Default DEBUG port settings are: 115200, 8, N, 1 (baud rate, data bits, parity, stop bits). For more details, see the HAWK 8000 – Installation & Startup Guide (EN1Z-1027GE51).

**NOTE:** Logging in will require admin-level platform credentials.

The SHT/DWN pushbutton initiates a "controlled shutdown" of the controller, ensuring that all station data is preserved. This provides an alternative to the platform "stop station" command, while connected online with the controller.

### Initiating a Controller Shutdown

When locally servicing an installed and configured (commissioned) unit, use this feature before removing power.

**NOTE:** Do not initiate a shutdown or remove power if:  
 The BACKUP LED is flashing in the "working mode" pattern or  
 The BEAT LED is flashing at a 90% / 10% ON/OFF rate.  
 Instead, wait for the BACKUP LED to change to a different state (typically: OFF), and for the BEAT LED to flash at the normal 50% / 50% ON/OFF duty cycle rate before initiating a shutdown.

**Prerequisite:** The HAWK 8000 controller must have been commissioned (Niagara 4 installed, platform configured, a station installed) and the unit must be running the station.

1. Press and hold down the recessed SHT/DWN button just until the BACKUP LED begins flashing in the "alert mode" pattern: 100 ms ON / 100 ms OFF, repeating (fast).
2. Release the SHT/DWN button during this alert mode. This starts the shutdown process, where the station and the software are put into a safe state. During this shutdown, the BACKUP LED flashes in the "working mode."
3. When the shutdown has been completed, the BACKUP LED will turn OFF. You can now safely remove 24V power from the unit.

**NOTE:** In cases where the system cannot be put into a safe state, the BACKUP LED will flash in the "error mode" pattern: two quick (200 ms) flashes ON, 3 seconds OFF, repeating.

## ORDER NUMBERS

**Table 3. Hardware-only controllers, for new and replacement**

order no.	description
CLNXSERIES8	HAWK8 NO WIFI W/O LICENSE
CLNXSERIES8W02	HAWK8 WITH WIFI ZONE 2 W/O LICENSE

Every HAWK 8000 requires one of the following basic software licenses.

**Table 4. HAWK 8000 basic software licenses**

order no.	description
CLNXHAWK8-8005	HAWK8 BASE LIC 250 POINTS
CLNXHAWK8-8010	HAWK8 BASE LIC 500 POINTS
CLNXHAWK8-8025	HAWK8 BASE LIC 1250 POINTS
CLNXHAWK8-8100	HAWK8 BASE LIC 5000 POINTS
CLNXHAWK8-8100P	HAWK8 BASE LIC 100 POINTS
CLNXHAWK8-8200	HAWK8 BASE LIC 10000 POINTS
CLNXHAWK8-DEMO	HAWK8 DEMO LICENSE

**Table 5. Expansion Modules**

order no.	description
HON-NXEM-LON	LON EXPANSION MODULE SINGLE PORT
HON-NXEM-2X485	RS485 EXPANSION MODULE DUAL PORT
HON-NXEM-232	RS232 EXPANSION MODULE SINGLE PORT

**Table 6. Spare parts**

order no.	description
CLNXHAWK8-CLIP	HAWK8 CENTRALINE CLIP
CLNXHAWK8-SD	HAWK8 SD CARD
HON-NX8-KIT	WIFI-ANTENNA + RS485 + POWER TERMINALS

**Table 7. Point upgrade licenses**

order no.	description
CLNX-DEVICE-UP-10	HAWK8 PLUS 500 POINTS UPGRADE
CLNX-DEVICE-UP-25	HAWK8 PLUS 1250 POINTS UPGRADE
CLNX-DEVICE-UP-50	HAWK8 PLUS 2500 POINTS UPGRADE

**Table 8. Software upgrade licenses**

order no.	description
CLNX-SMA-8005-1YR	HAWK8 1YR SW UPDATE 250-499 PTS
CLNX-SMA-8005-3YR	HAWK8 3YR SW UPDATE 250-499 PTS
CLNX-SMA-8005-5YR	HAWK8 5YR SW UPDATE 250-499 PTS
CLNX-SMA-8010-1YR	HAWK8 1YR SW UPDATE 500-1249 PTS
CLNX-SMA-8010-3YR	HAWK8 3YR SW UPDATE 500-1249 PTS
CLNX-SMA-8010-5YR	HAWK8 5YR SW UPDATE 500-1249 PTS
CLNX-SMA-8025-1YR	HAWK8 1YR SW UPDATE 1250-4999 PTS
CLNX-SMA-8025-3YR	HAWK8 3YR SW UPDATE 1250-4999 PTS
CLNX-SMA-8025-5YR	HAWK8 5YR SW UPDATE 1250-4999 PTS
CLNX-SMA-8100-1YR	HAWK8 1YR SW UPDATE 5000-9999 PTS
CLNX-SMA-8100-3YR	HAWK8 3YR SW UPDATE 5000-9999 PTS
CLNX-SMA-8100-5YR	HAWK8 5YR SW UPDATE 5000-9999 PTS
CLNX-SMA-8200-1YR	HAWK8 1YR SW UPDATE 10000+ PTS
CLNX-SMA-8200-3YR	HAWK8 3YR SW UPDATE 10000+ PTS
CLNX-SMA-8200-5YR	HAWK8 5YR SW UPDATE 10000+ PTS

**Table 9. Miscellaneous licenses**

order no.	description
CLNX-JACE-8000-AX	HAWK8 ENABLER FOR NIAGARA AX
CLNX-DR-MFID	NX FIDELIO DRIVER
CLNX-DR-SMS-ALM	NX SMS DRIVER

## DRIVERS

### Included Drivers

- Niagara NX drivers
  - BACnet IP
  - BACnet MS/TP
  - FOX ("inter-station" communication, i.e. to a supervisor or other HAWK controllers)
  - KNX-IP
  - LON
  - M-Bus
  - Modbus, all types
  - oBIX
  - Open ADR
  - SNMP
- CentraLine-specific drivers
  - Panel Bus
  - C-Bus
  - LON IO
  - Print-Out
  - IO Creation
  - Bacnet Util
  - Extensions
  - EnOcean

### Optional Drivers

- Niagara NX drivers
  - SMS (see also Table 9 above)
  - Fidelio (see also Table 9 above)
- CentraLine-specific drivers (under preparation)
  - Application Library
  - Energy Vision

## SPECIFICATIONS

### Power

Voltage:	24 VAC/DC (50/60 Hz)
Max. power consumption:	18 VA (without Expansion Modules); 20 VA (fully loaded with Expansion Modules)
Rec. power supply:	24 VAC (24 VA) / 24 VDC (1 A)

### Environmental Specifications

Operating temperature:	-20 ... +60 °C
Storage temperature:	-40 ... +85 °C
Humidity:	5 ... 95%, non-condensing
Shipping and vibration:	ASTM D4169, Assurance Level II
MTTF:	+10 years
Dimensions:	See Fig. 3 to Fig. 5.

## APPROVALS, CERTIFICATIONS, ETC.

- UL 916, Energy Management Equipment – Edition 4
- CE: 2014/53/EU RED, 2011/65/EU RoHs
- FCC Part 15, Subpart B, Class B; Part 15, Subpart C
- C-UL listed to Canadian Standards Assoc. (CSA) C22.2 No. 205-M1983 "Signal Equipment"
- Ethernet: IEEE 802.3
- Purpose of the device is: multifunctional non-safety control intended for HVAC in home (residential, commercial, and light-industrial) environments

**NOTE:** Keep AC mains supply/load cables separate from signal wiring!

## RELATED TECHNICAL LITERATURE

Table 10. Related Technical Literature

Title	Product Literature no.
HAWK 8000 – Installation & Comm. Instructions	EN1Z-1016GE51
HAWK 8000 – Product Data	EN0Z-1016GE51
HAWK 8000 – Mounting Instructions	MU1Z-1016GE51
HAWK 8000 – Installation & Startup Guide	EN1Z-1027GE51
HAWK 8000 – Backup & Restore Guide	EN2Z-1027GE51
HAWK 8000 – PICS	EN0Z-1028GE51
HAWK 8000 – WiFi Guide	EN2Z-1029GE51
HON-NXEM-xxx Expansion Modules – M.I.	MU1Z-1031GE51
Panel Bus I/O Modules – Product Data	EN0Z-0979GE51

Manufactured for and on behalf of the Environmental & Energy Solutions Division of Honeywell Technologies Sàrl, Rolle, Z.A. La Pièce 16, Switzerland by its Authorized Representative:

CentraLine  
Honeywell GmbH  
Böblinger Strasse 17  
71101 Schönaich, Germany  
Phone +49 (0) 7031 637 845  
Fax +49 (0) 7031 637 740  
[info@centraline.com](mailto:info@centraline.com)  
[www.centraline.com](http://www.centraline.com)

Subject to change without notice  
EN1Z-1016GE51 R1119

