

IQECO31/24VAC BACnet MS/TP Terminal Unit Controller

Important: Retain these instructions

These instructions shall be used by trained service personnel only. If the equipment is used in a manner not specified by these instructions, the protection provided by the equipment may be impaired.

<https://partners.trendcontrols.com>



CONTENTS

1	Unpacking	1	3	Installation	1
2	Storing	1	3.1	Installation - Mounting.....	1
			4	Removing from DIN Rail	10
			5	Cleaning and Maintenance	11

1 BOX CONTENTS

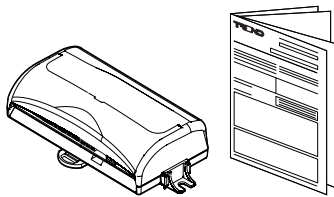

IQECO31/24VAC
Installation Instructions
- Mounting (TG201223)

2 STORING

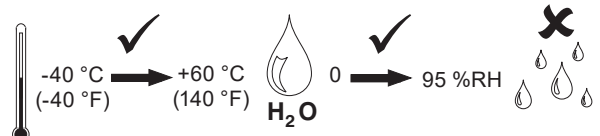

Note, For temperatures below zero special care must be taken that there is no condensation on or within the unit.

3 INSTALLATION

Labels used on IQ™ ECO31/24VAC

	Service button
	Connector for Wallbus displays
	Connector for MS/TP trunk
	Connector for USB
	Connector for 24 Vac input power.
	Connector for Universal Input
	Connector for Digital Input
	Connector for Thermistor Input
	Connector for Analogue Output
	Connector for Solid State Digital Output

It is recommended that the installation should comply with the local electrical safety installation practices (e.g. HSE Memorandum of Guidance on Electricity at Work Regulations 1989, USA National Electric Code).

MS/TP Network
This product should be connected to a BACnet MS/TP network. The network installation requirements are different from an IQL on its LONWORKS® network.

WARNING Removal of cover exposes dangerous voltages.

	Connector for Relay Output
	MSTP OK LED
	Caution, consult documentation
	Caution, possibility of electric shock

3.1 Installation - Mounting

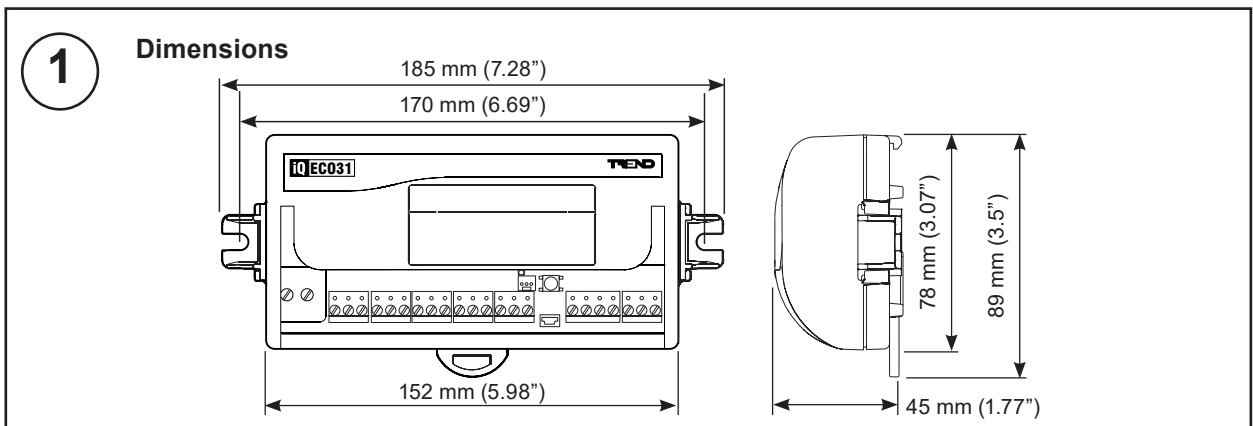

3.1 Installation - Mounting (continued)

2 Mounting Requirements

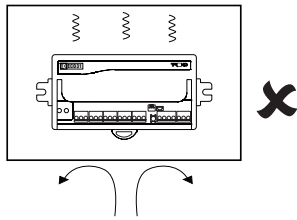

Altitude <2000 m (6562')
 Pollution degree 2 (Only non-conducting pollution occurs)

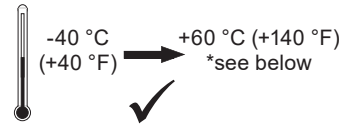

If mounted on DIN rail or for UL rating the unit must be installed in an enclosure rated to at least IP20 or equivalent.

Note: For temperatures below zero special care must be taken that there is no condensation on or within the unit.

The unit is UL rated as 'UL916 listed open energy management equipment'.

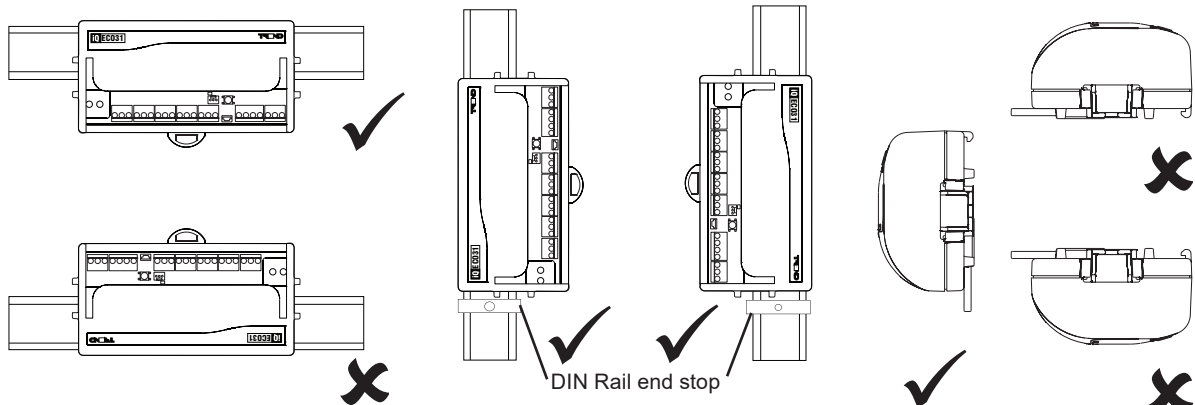
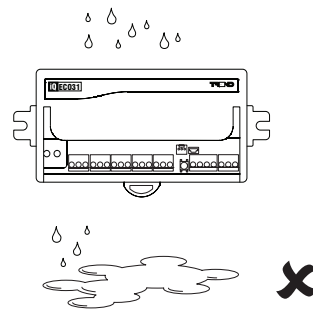
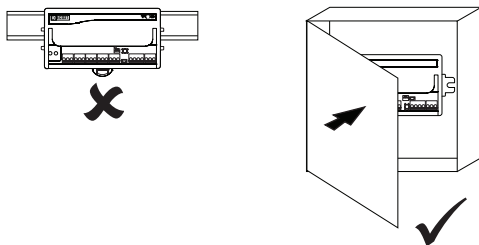

If DIN rail mounted the surface mount brackets can be removed.

3 Lift Hinged Covers

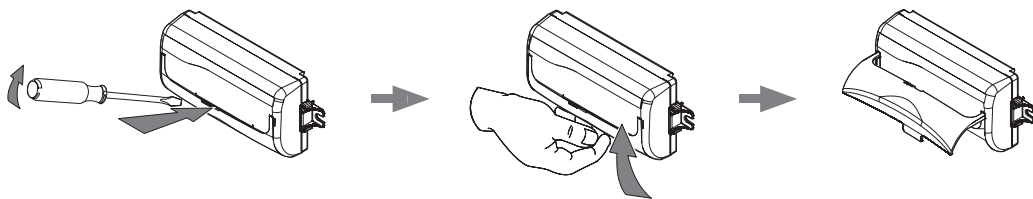

CAUTION: Failure to use a screwdriver to open the cover will cause damage to the unit.

3.1 Installation - Mounting (continued)

4

Mount Unit

Either: DIN rail mounting

Or: surface mounting

5

Connect Power

24VAC
ensure correct polarity

24V 0V $\frac{1}{2}$
1 2 3

24Vac

24 Vac transformer
(For UL rating use Class 2)

Must connect to known earth (ground)

Terminal size 0.14 to 2.5 mm² (22 to 12 AWG)

Terminals can exceed 60 °C (140 °F) in normal use. Ensure wire/cable rating has an appropriate temperature rating. Wire/Cable rated to 105 °C (221 °F) is recommended.

For UL rating the input power connections must be made using 18 AWG or larger wire rated at least 90 °C (194 °F).

This equipment must be earthed (grounded).

A panel/enclosure clean earth (ground) consisting of a short (<300 mm, 12") stranded copper wire (>=1.5 mm², 16 AWG) to a short substantial earthed (grounded) metal part is recommended.

24VAC 24 Vac ±15% 50/60 Hz, at 26 VA max (under full load)
The 24 V supply must include a suitably rated switch in close proximity and be clearly marked as the disconnecting device for the unit.

Do not position the equipment so that the disconnecting device is difficult to operate.

DO NOT SWITCH ON POWER

3.1 Installation - Mounting (continued)

6

Connect Inputs/Outputs - Overview

Connectors with screw terminals; all plug-in except relay output which is single part only.



Terminal size: 0.14 to 2.5 mm² (22 to 12 AWG).
 For UL rating use 22 to 14 AWG - Cu only cable.
 Twisted pair cable recommended for all inputs/outputs e.g. TP/1/1/22/HF/200 (Belden 8761)
 Screened cable is not generally required unless the cable passes through electrically noisy environments. If used, the screen must be connected to the local panel/enclosure ground and left unterminated at the far end.

7

Connect Solid State Digital Outputs (OUT5, OUT6, OUT7, OUT8)

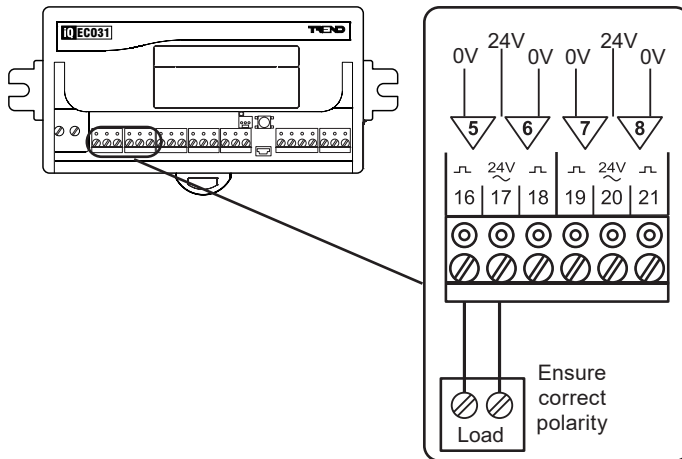

24 Vac: see IQECO 31, 32, 35, 38 Data Sheet (TA201176) to calculate available current.

8

Connect Analogue Output (OUT9)

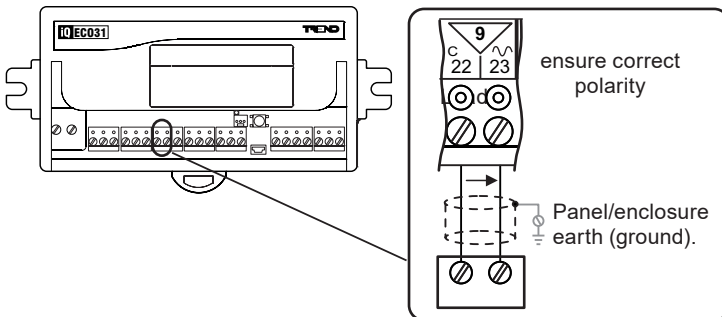

0 to 10 Vdc. Part of 21 Vdc combined supply shared with wallbus and auxiliary supply output, see IQECO 31, 32, 35, 38 Data Sheet (TA201176) to calculate available current.

9

Connect Relay Output (OUT1) ⚠

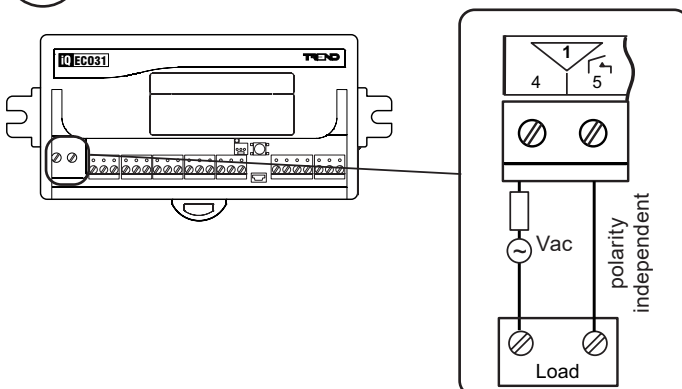

250 Vac 5 A make only relay. UL rating applies up to 30V.

Arc suppression recommended.
 Relay Output Arc Suppression
 Installation Instructions (TG200208)

Ensure that external circuits are suitably protected against fault currents that would exceed the ratings for the switching circuits provided in this product.

3.1 Installation - Mounting (continued)

10

Connect Inputs IN1, IN2, IN3, IN4

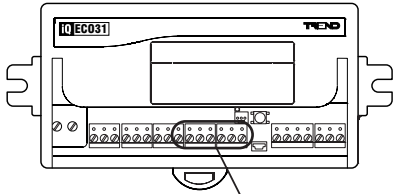

The '+' terminal is part of 24 Vdc combined supply shared with wallbus and the analogue output, see IQECO 31, 32, 35, 38 Data Sheet (TA201176) to calculate available current.

For universal inputs the sensor type module used for the input channel (as set up in the strategy) sets up the input conditioning (no linking required).

Example connections of TB/TS room temperature sensor, adjustment knob, and occupation override, inputs.

Note: The '+' terminal (24) provides +24 Vdc ±15% at 20 mA maximum nominal auxiliary supply out.

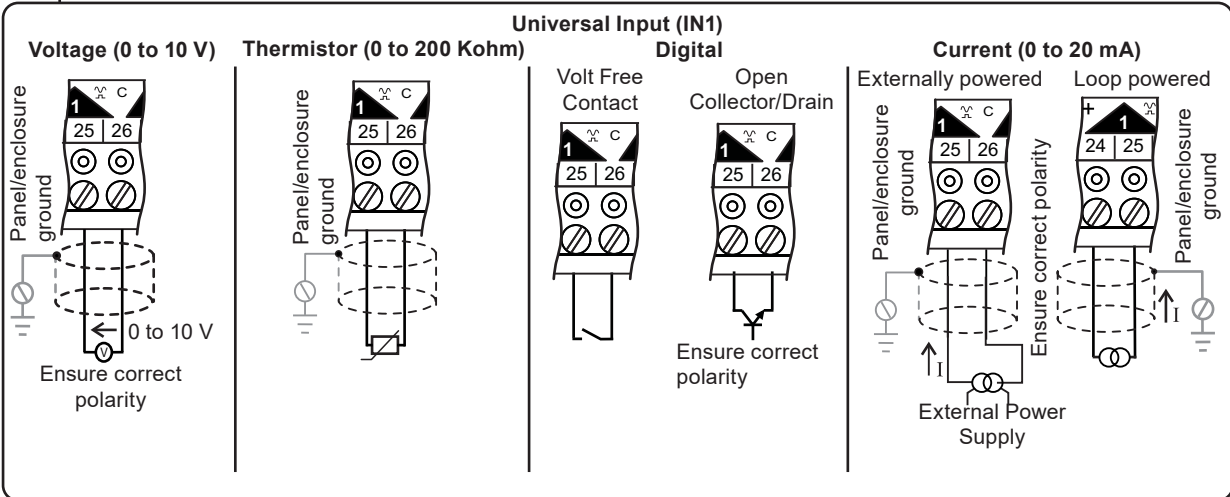
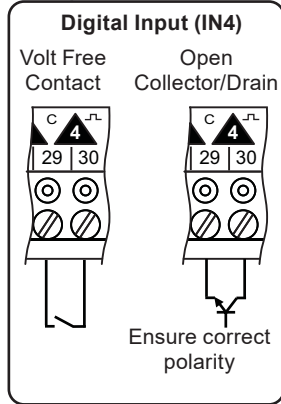
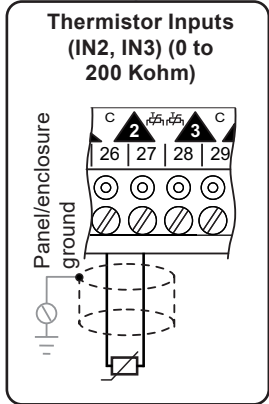
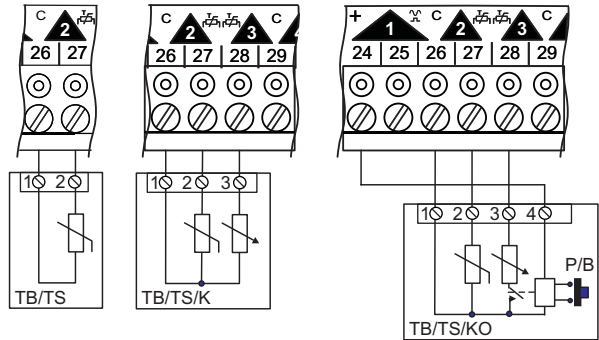
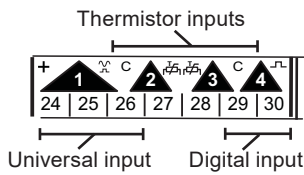

3.1 Installation - Mounting (continued)

11 Connect MS/TP Trunk

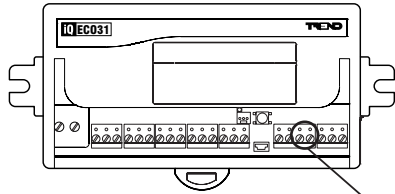

Lay cable as bus topology (not loop or star).

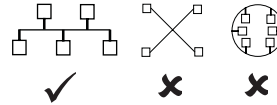

Ensure correct polarity. Ensure maximum number of devices described below is not exceeded.

Earthing: Connect all ground terminals and 24 Vac power supply neutrals to the panel/enclosure ground. Ensure normal safety earthing (grounding) practice.

Cable specification/Maximum length: Use tinned copper, screened, twisted-pair cable with characteristic impedance between 100 and 130 ohms. Distributed capacitance between conductors shall be less than 100 pF per meter (30 pF per foot). Distributed capacitance between conductors and screen shall be less than 200 pF per meter (60 pF per foot). Foil or braided screens are acceptable. The maximum recommended length of an MS/TP segment is 1200 meters (4000 feet) with AWG 18 (0.82 mm²) conductor area) cable. There may be up to 3 repeaters between devices. The use of greater distances and/or different wire gauges shall comply with the electrical specifications of EIA-485. Details of recommended cable are given in the Trend TP Cable Data Sheet (TA200541).

***Screen** Each MS/TP segment must have a single point screen ground. Screen should be continuous. Do not ground the MS/TP screen using a controller terminal. Ground screen at one end and cut back at the other end. At connecting points, tie the screen through a terminal.

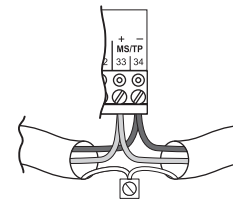
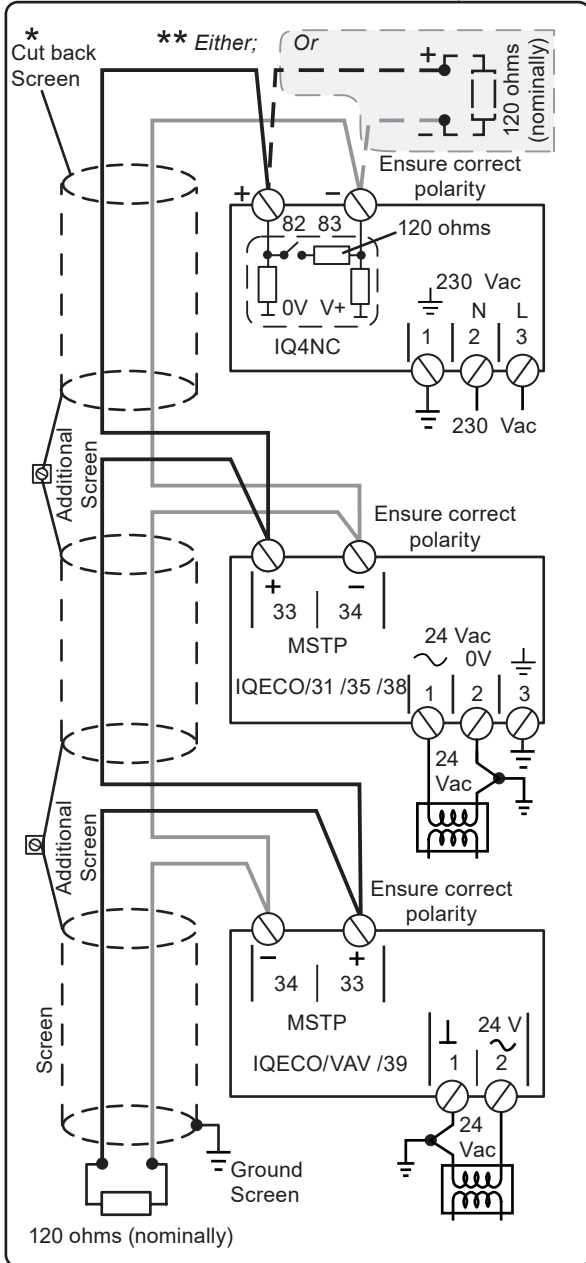

Additional Terminal

****Terminators:** The bus must be terminated at each end with a resistor matched to the cable characteristic impedance (i.e. ±1%, ¼ Watt, range 100 to 130 ohms). If the IQ4NC is at one end of a 120 ohm cable, switch in its built-in terminator, otherwise switch it out and fit a resistor at that end of the cable; the other end must be terminated with a matching resistor.

Maximum number of devices: There may be IQ4NC with up to 64 IQECO's or other manufacturers' devices on the MS/TP trunk. A separate limitation is that the MS/TP segment supports up to 32 'unit' loads. IQECO, IQ4NC and IQ3/BINC present a ¼ BACnet 'unit' load; other manufacturers' devices may have different 'unit' loads.

Biasing The IQ4NC provides network biasing (470 ohms); a maximum of two devices on the network can provide network biasing.

Failure to comply with these practices will result in significant impairment of the communication performance.

3.1 Installation - Mounting (continued)

12 Connect to Wallbus Device (if required)

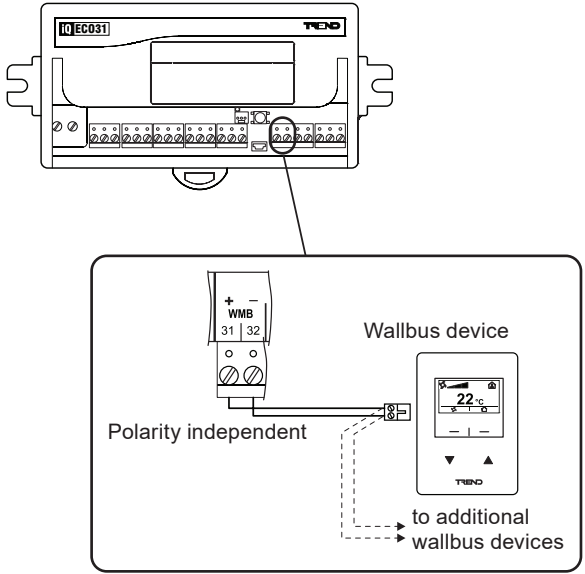

The IQECO can communicate with up to 14 wallbus devices (e.g. room sensor or display) dependant on available controller memory and power requirements of connected devices. It uses part of 21 Vdc combined supply shared with the analogue output and auxiliary supply outputs, see IQECO 31, 32, 35, 38 Data Sheet (TA201176) to ensure sufficient current is available for wallbus device.

Terminal size 0.14 to 2.5 mm² (22 to 12 AWG). Use twisted pair cable maximum length 60 m (200 feet). For UL rating use 22 to 14 AWG - Cu only cable.

Note: These terminals provide power to connected Wallbus product that is within the limits described by EN60950-1 (table 2B).

Number of devices: Up to 14 (subject to power loading - refer to device documentation and controller memory).

IQECO Configuration Manual (TE201089)

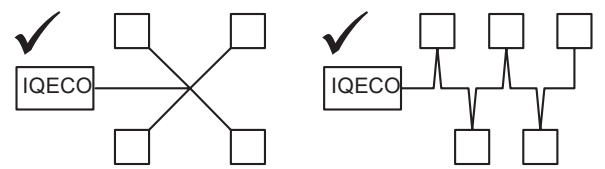

13 Close Hinged Covers

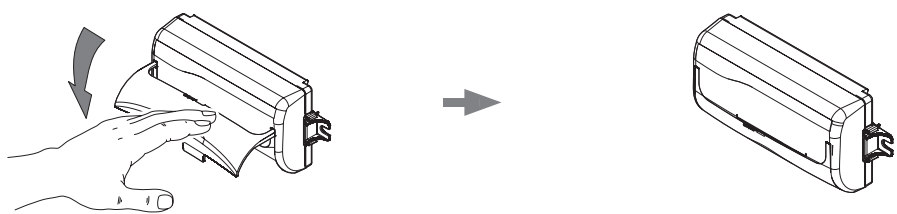

14 Close Enclosure

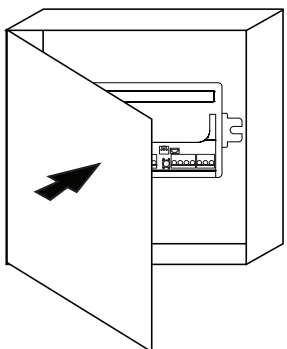

15 Configure IQECO

IQECO31, 35, 38 Installation Instructions - Configuration (TG201222)

4 CLEANING AND MAINTENANCE

The IQ4E requires no routine maintenance



WARNING Contains on servicable parts. Do not attempt to open the unit. Failure to comply may cause damage to the unit.

5 DISPOSAL



WEEE Directive:

At the end of their useful life the packaging and product should be disposed of by a suitable recycling centre.

Do not dispose of with normal household waste.

Do not burn.

Please send any comments about this or any other Trend technical publication to techpubs@trendcontrols.com

© 2021 Honeywell Products and Solutions SARL, Connected Building Division. All rights reserved. Manufactured for and on behalf of the Connected Building Division of Honeywell Products and Solutions SARL, Z.A. La Pièce, 16, 1180 Rolle, Switzerland by its Authorized Representative, Trend Control Systems Limited.

Trend Control Systems Limited reserves the right to revise this publication from time to time and make changes to the content hereof without obligation to notify any person of such revisions or changes.

Trend Control Systems Limited

St. Mark's Court, North Street, Horsham, West Sussex, RH12 1BW, UK. Tel: +44 (0)1403 211888, www.trendcontrols.com



EAC

TR CU Certification