



# B200S-WH, B200S-IV

## Intelligent Sounder Base

3825 Ohio Avenue, St. Charles, Illinois 60174  
 1-800-SENSOR2, FAX: 630-377-6495  
 www.systemsensor.com

This model is compatible with Sytem Sensor Models MDL, MDL3R, MDLW, MDL3W and SYNC-1

**SPECIFICATIONS**

Base Diameter:	6.875" (17.46 cm)
Base Height (less sensor):	2.0" (5.08 cm)
Weight:	0.50 lb. (227 gm)
Operating Temperature Range:	Refer to applicable sensor Operating Temperature Range using the Base/Sensor Cross Reference Chart at systemsensor.com
Operating Humidity Range:	10% to 93% relative humidity (non-condensing)

**External Supply Electrical Ratings**

External Supply Voltage:	16 to 33 VDC (VFWR)
Standby Current:	500 µA maximum
Alarm Current:	35 mA maximum (at high volume setting); 15 mA maximum (at low volume setting)

**SLC Electrical Ratings**

SLC Operating Voltage:	15 to 32 VDC
SLC Standby Current:	300 µA maximum

**Sound Output**

High Volume:	Greater than 85 dBA minimum measured in a UL reverberant room at 10 feet, 24 Volts (in continuous tone)
Low Volume:	Greater than 75 dBA minimum measured in a UL reverberant room at 10 feet, 24 Volts (in continuous tone)

**BEFORE INSTALLING**

Read System Sensor’s Applications Guide for System Smoke Detectors (SPAG91), which provides detailed information on sensor spacing, placement, zoning, wiring, and special applications. This manual is available online at www.systemsensor.com. NFPA 72 and NEMA guidelines should be observed.

**NOTE:** Select Series sounder bases are not compatible with remote test capable Select Series detectors.

**NOTICE:** This manual should be left with the owner/user of this equipment.

**IMPORTANT:** The detector used with this base must be tested and maintained regularly following NFPA 72 requirements. The detector should be cleaned at least once a year.

**GENERAL DESCRIPTION**

The B200S-WH and B200S-IV sounder bases are used with addressable detector heads. For a list of compatible sensors, refer to the System Sensor website at www.systemsensor.com. Refer to the appropriate manual for more information on sensors.

The B200S-WH and B200S-IV sounder bases were designed specifically to meet the needs of dwelling unit applications. They offer maximum flexibility in configuration and operation to meet or exceed the requirements of UL268 and UL464.

The sounder base is capable of producing a variety of tone patterns, including the distinctive three-pulse temporal pattern (ANSI Temporal 3) fire alarm signal now required by NFPA 72 for commercial and residential applications.

The B200S-WH/B200S-IV can be commanded by the Fire Alarm Control Panel to adopt the address of the attached sensor head, but as a unique device type on the loop. By using the address, the fire alarm control panel can command an individual sounder base to activate, or a group of sounders in a suite or other multi-room configuration. The command set from the panel can be tailored to the specific event, allowing selection of volume, tone, and group. The device offers two volume levels: 75 dBA and 85 dBA. The available tones are Continuous, ANSI Temporal 3, ANSI Temporal 4, and March Time. In addition, some fire alarm panels will offer the ability to command a custom tone pattern. Refer to the appropriate fire alarm control panel manual for more information.

In addition, the B200S-WH/B200S-IV is equipped with the circuitry to recognize the System Sensor synchronization protocol, enabling the sounder base to be used as a component of the general evacuation signal – producing an NFPA 72 compliant Temporal 3 pattern in synchronization with other System Sensor notification devices. This requires connection to a power supply capable of generating the System Sensor synchronization pulses, a FACP NAC output configured to System Sensor synchronization protocol, or a separate synchronization module.

The sounder base is intended for use with intelligent systems. In addition to being connected to the SLC, the sounder base requires a connection to either 24 VDC constant power or a NAC circuit, depending on the FACP and intended use. The connections for 24V constant/NAC power and the communication loop are isolated to prevent electrical interaction between them.

When connected to a NAC, power is supervised via the NAC circuit supervision while in standby mode (EOL resistor required for Class B operation). When activated, the B200S-WH/B200S-IV provides supervision of NAC power. (See Figure 56.)

When using a FACP equipped with a “sounder base standby power monitoring” mode and constant 24 V power, power supervision EOL devices (supervision relays and resistors) should not be used. (See Figure 4.) In this case, the B200S-WH/B200S-IV will provide supervision in both standby and alarm/active mode. Refer to FACP installation documentation to determine if this mode is available. If your FACP does not support this mode or you choose not to use it, power supervision relays and EOL resistors are required to provide supervision in standby mode.

**NOTE:** If the FACP’s “sounder base standby power monitoring” mode is enabled, connecting B200S-WH/B200S-IV sounder bases to the NAC will result in power supervision failure when in standby. Only connect B200S-WH/B200S-IV sounder bases to constant 24 V power in this case. Refer to the panel manual for maximum allowable number of units per loop.

**NOTE:** For NFPA 72 Installations, the Temporal 3 tone at high volume should be used for public mode evacuation. The use of other tone styles and low volume level will be at the discretion of the local Authority Having Jurisdiction (AHJ).

**NOTE:** When not used as a supplementary evacuation system, the external 24 VDC supply shall be treated as a component of the main power supply system and shall fall under the requirements of the main power supply system per NFPA 72.

**WIRING GUIDELINES**

All wiring must be installed in compliance with the National Electrical Code and the local codes having jurisdiction and must not be of such length or wire size which would cause the base to operate outside of its published specifications. The conductors used to connect smoke sensors to control panels and accessory devices should be color coded to reduce the likelihood of wiring errors. Improper connections can prevent a system from responding properly in the event of a fire.

Wire sizes up to 12 AWG (2.5 mm<sup>2</sup>) may be used with the base. The sounder base will be shipped with the screw terminals set for 14 AWG wiring. If 12 AWG wire is to be used, back out the screws to allow the wire to fit beneath the clamping plates. For best system performance, the power (+ and -) wires and the communication circuit wires should be twisted pair or shielded cable

installed in a separate grounded conduit to protect the communication loop from electrical interference.

Make wire connections by stripping about 3/8" of insulation from the end of the wire. Then, slide the bare end of the wire under the appropriate clamping plate (See Figure 1), and tighten the clamping plate screw. Do NOT loop the wire under the clamping plate. (See Figure 2.) The wiring diagram for a typical 2-wire intelligent system is shown in Figure 4.

**CAUTION**

For system monitoring - for terminals 2, 3, 4, and 5, do not use looped wire under terminals. Break wire run as shown in Figure 2 to provide monitoring of connections.

**FIGURE 1.**

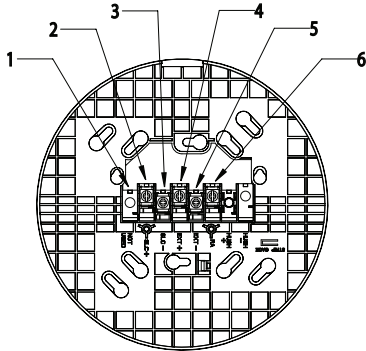

C0471-07

**FIGURE 2.**

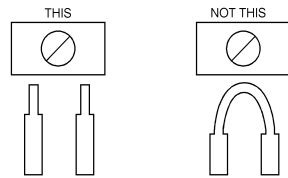

C0473-00

**B200S-WH/B200S-IV TERMINALS**

No. Function

1. Not Used
2. Positive (+) Comm. Line In and Out
3. Negative (-) Comm. Line In and Out
4. External Supply Positive (+)
5. External Supply Negative (-)
6. Remote Annunciator

**FIGURE 3. MOUNTING**

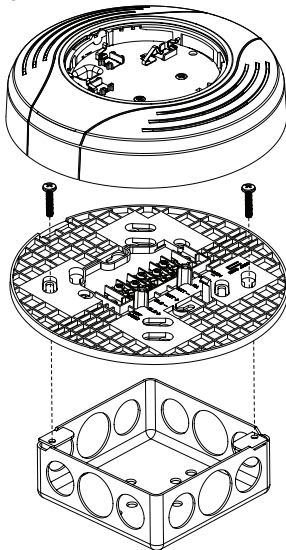

C0891-07

**MOUNTING**

Mount the B200S-WH/B200S-IV mounting plate directly to an electrical box. The plate will mount directly to 4" square (with and without plaster ring), 4" octagon, 3 1/2" octagon, single gang or double gang junction boxes.

1. Connect field wiring to terminals, as shown in Figure 1 and 2.
2. Attach the mounting plate to the junction box as shown in Figure 3.
3. To mount the sounder base, hook the tab on the sounder base to the groove on the mounting plate.
4. Then, swing the sounder base into position to engage the pins on the product with the terminals on the mounting plate.
5. Secure the sounder base by tightening the mounting screws.
6. Install a compatible smoke sensor as described in the installation manual for the sensor.

**CAUTION**

Do not over tighten mounting plate screws; this may cause mounting plate to flex.

**TAMPER RESISTANT FEATURE**

NOTE: Do not use the tamper-resist feature if the removal tool is to be used. This detector base includes a tamper-resist feature that prevents its removal from the base without the use of a tool. To activate this feature, break the tab from the detector base as shown in Figure 7A. Then, install the detector. To remove the detector from the base once the tamper-resist feature has been activated, insert a small-bladed screwdriver into the slot from the top and press down on the lever (see Figure 7B). This allows the detector to be rotated counterclockwise for removal. The tamper-resist feature can be defeated by breaking and removing the plastic lever from the base. However, this prevents the feature from being used again.

**TESTING AND MAINTENANCE**

Sensors and bases must be tested after installation and as an integral part of a periodic maintenance program. Test the B200S-WH/B200S-IV as follows:

NOTE: Before testing, notify the proper authorities that the smoke sensor system is undergoing maintenance and, therefore, will be temporarily out of service. Disable the system undergoing maintenance to prevent unwanted alarms.

1. Via the fire alarm control panel, command the individual B200S-WH/B200S-IV to activate using the associated sensor address. That sounder base should sound in approximately five seconds.
2. Via the fire alarm control panel, command all B200S-WH/B200S-IV sounder bases to activate using group communication to all associated addresses. All devices on the loop should sound, and if a temporal tone is commanded, the tones can be synchronized to each other.

NOTE: Synchronization requires a power supply capable of producing the System Sensor synchronization pulses or a synchronization module.

When performing maintenance on connected smoke sensors, carefully note the location and address of each removed sensor. When re-installed, the B200S-WH/B200S-IV will confirm that address of the sensor matches the address stored in the sounder base memory. If there is a mismatch, this will be communicated to the fire alarm control panel and the sounder base can be commanded to chirp at regular intervals until the correct head is installed.

If a replacement head is installed or address changes are required, the mismatch may be resolved at the panel by commanding the B200S-WH/B200S-IV sounder base to re-enter its address learning mode and adopting the address of the new sensor.

**FIGURE 4. WIRING DIAGRAM**

**(CONNECTED TO 24V POWER USING COMPATIBLE FACP WITH "SOUNDER BASE STANDBY POWER MONITORING" ENABLED)**

NOTE: Only use this wiring diagram when connecting to 24VDC power using a FACP listed in the table on page 1. Please consult your FACP manufacturer for panel-specific wiring configurations and special cases.

Additional Audible Visible devices may be connected to the same power supply or the the NAC output of the Fire Alarm Control Panel (FACP) to provide a synchronized communication of the alarm signal.

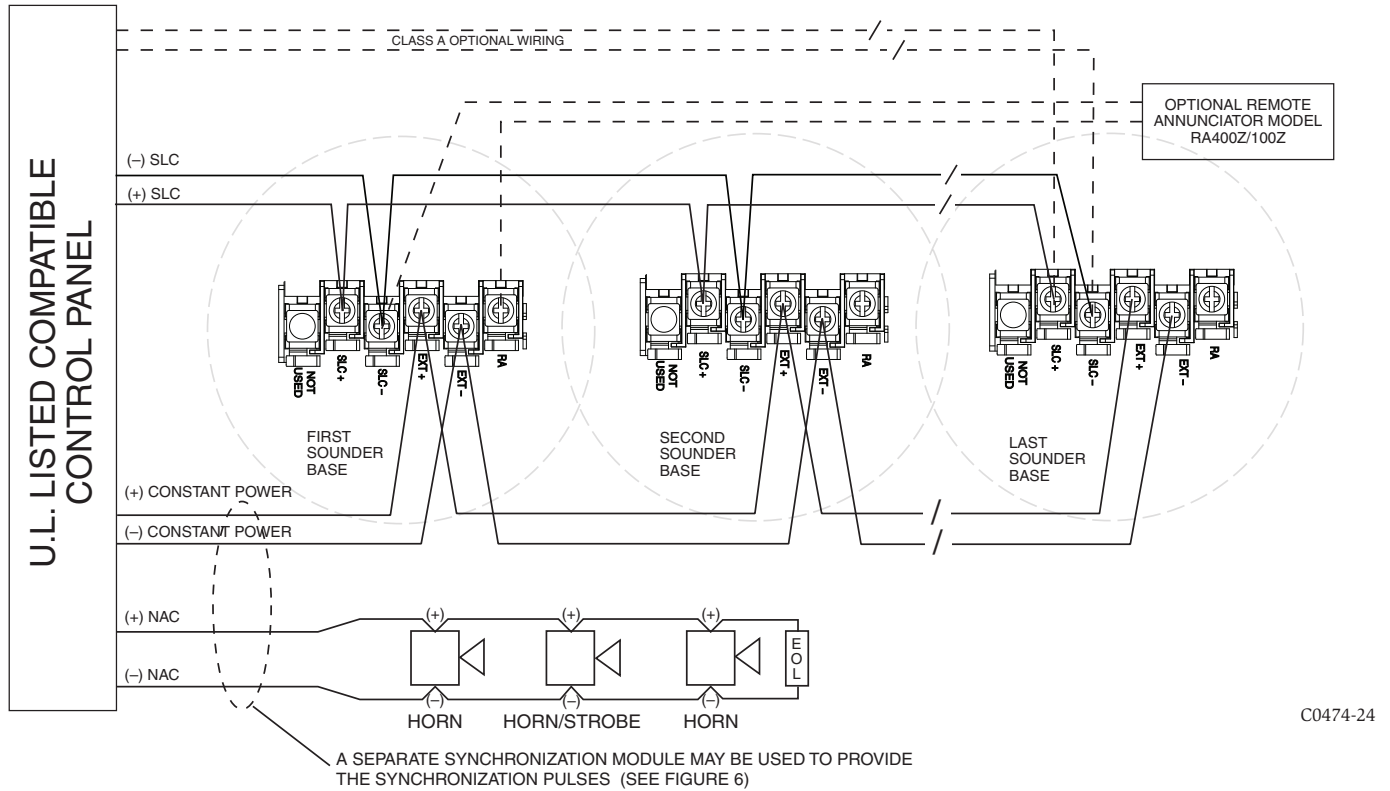

C0474-24

**FIGURE 5. WIRING DIAGRAM (CONNECTED TO NAC OR 24V POWER; OPTIONAL EOL DEVICES FOR CONSTANT SUPERVISION)**

NOTE: Only use this wiring diagram when connecting to a NAC or a 24V power supply that does not support "sounder base standby power monitoring" (see page 1).

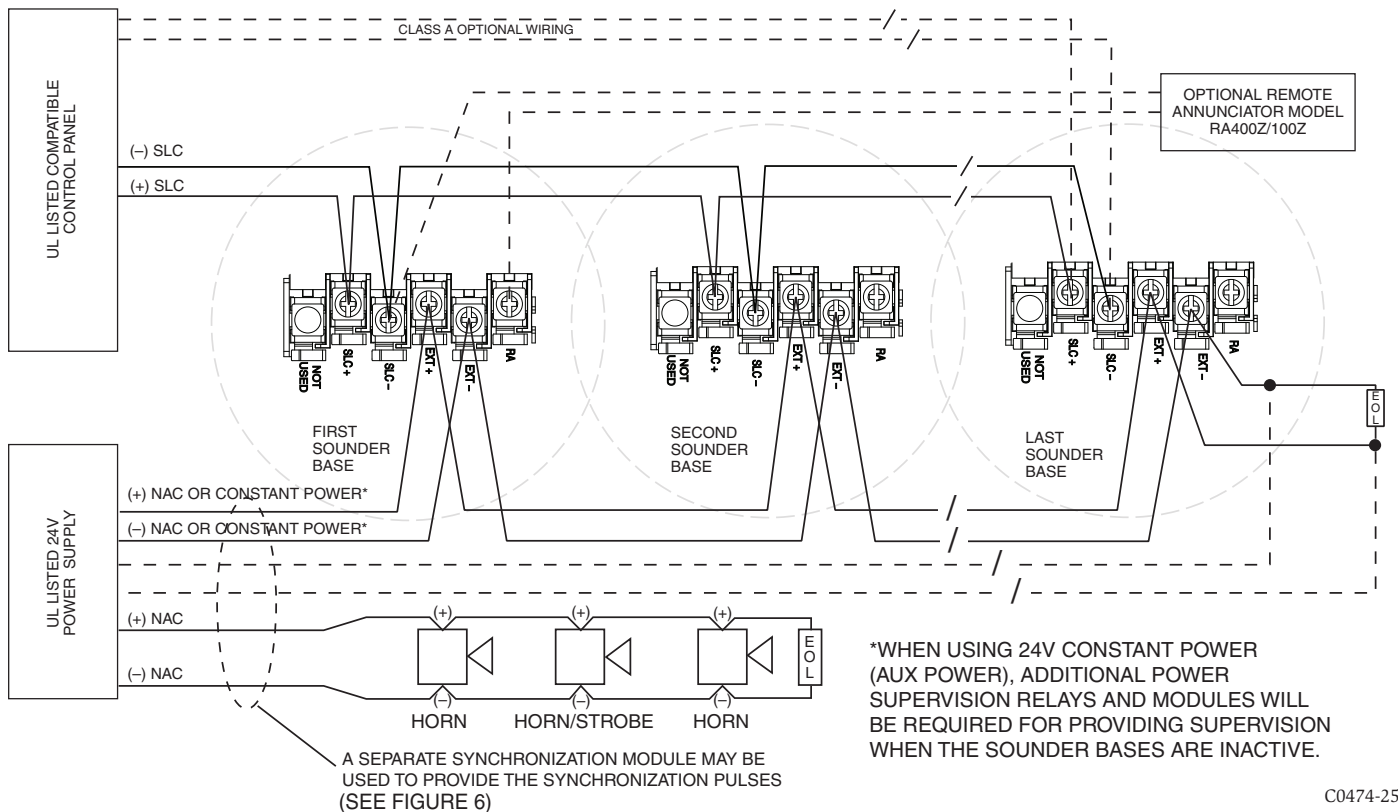

C0474-25

**FIGURE 6. SYNCHRONIZATION DIAGRAM (FOR MDL SERIES SYNC MODULES ONLY)**

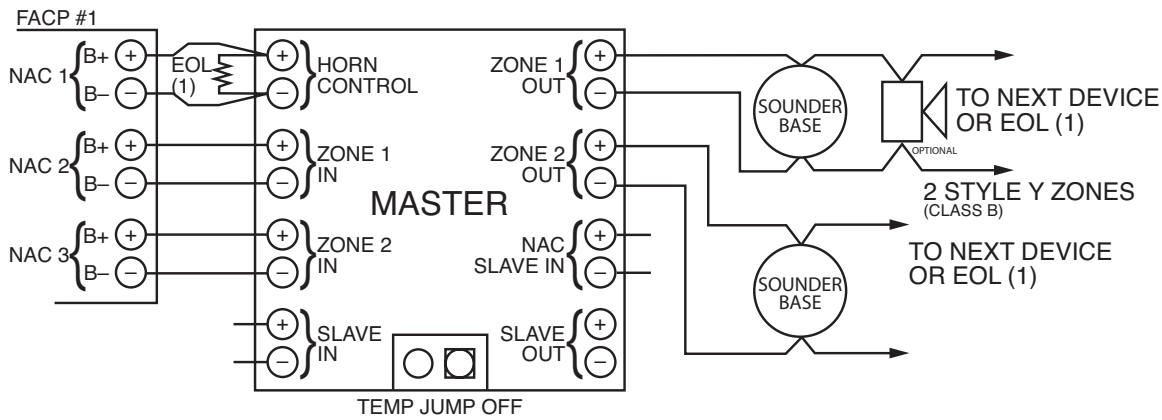

C1090-00

NOTE: Wiring shown for System Sensor MDL Series Sync Module. For additional wiring configurations, see your sync module manual.

**FIGURE 7A. ACTIVATING THE TAMPER-RESIST FEATURE**

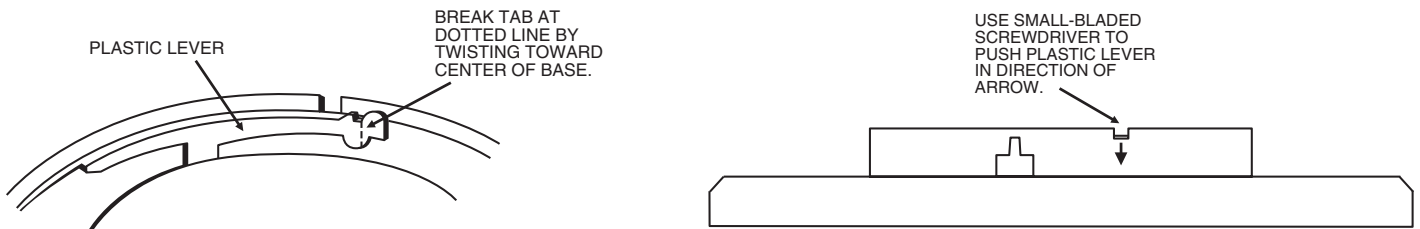

C0144-00

**FIGURE 7B. REMOVING THE DETECTOR HEAD FROM THE BASE**

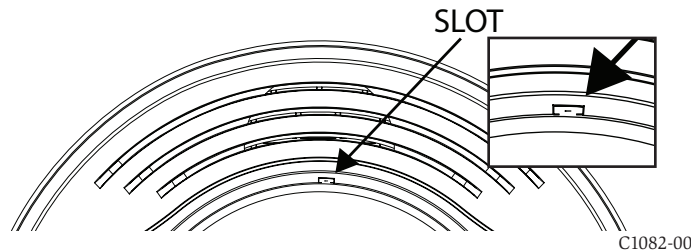

C1082-00

NOTE: B200S-WH and B200S-IV replace the previous model number B200S; all are functionally the same.

## Please refer to insert for the Limitations of Fire Alarm Systems

### THREE-YEAR LIMITED WARRANTY

System Sensor warrants its enclosed smoke detector base to be free from defects in materials and workmanship under normal use and service for a period of three years from date of manufacture. System Sensor makes no other express warranty for this smoke detector base. No agent, representative, dealer, or employee of the Company has the authority to increase or alter the obligations or limitations of this Warranty. The Company's obligation of this Warranty shall be limited to the repair or replacement of any part of the smoke detector base which is found to be defective in materials or workmanship under normal use and service during the three year period commencing with the date of manufacture. After phoning System Sensor's toll free number 800-SENSOR2 (736-7672) for a Return Authorization number, send defective units postage prepaid to: Honeywell,

12220 Rojas Drive, Suite 700, El Paso TX 79936, USA. Please include a note describing the malfunction and suspected cause of failure. The Company shall not be obligated to repair or replace units which are found to be defective because of damage, unreasonable use, modifications, or alterations occurring after the date of manufacture. In no case shall the Company be liable for any consequential or incidental damages for breach of this or any other Warranty, expressed or implied whatsoever, even if the loss or damage is caused by the Company's negligence or fault. Some states do not allow the exclusion or limitation of incidental or consequential damages, so the above limitation or exclusion may not apply to you. This Warranty gives you specific legal rights, and you may also have other rights which vary from state to state.