

IFP-2100 / IFP-2100ECS

Analog / Addressable Fire System
Emergency Communication System

Fire Alarm & Emergency Communication System Limitations

While a life safety system may lower insurance rates, it is not a substitute for life and property insurance!

An automatic fire alarm system—typically made up of smoke detectors, heat detectors, manual pull stations, audible warning devices, and a fire alarm control panel (FACP) with remote notification capability—can provide early warning of a developing fire. Such a system, however, does not assure protection against property damage or loss of life resulting from a fire.

An emergency communication system—typically made up of an automatic fire alarm system (as described above) and a life safety communication system that may include an autonomous control unit (ACU), local operating console (LOC), voice communication, and other various interoperable communication methods—can broadcast a mass notification message. Such a system, however, does not assure protection against property damage or loss of life resulting from a fire or life safety event.

The Manufacturer recommends that smoke and/or heat detectors be located throughout a protected premises following the recommendations of the National Fire Protection Association Standard 72 (NFPA 72), manufacturer's recommendations, State and local codes, and the recommendations contained in the Guide for Proper Use of System Smoke Detectors, which is made available at no charge to all installing dealers. This document can be found at <http://www.systemsensor.com/appguides/>. A study by the Federal Emergency Management Agency (an agency of the United States government) indicated that smoke detectors may not go off in as many as 35% of all fires. While fire alarm systems are designed to provide early warning against fire, they do not guarantee warning or protection against fire. A fire alarm system may not provide timely or adequate warning, or simply may not function, for a variety of reasons:

Smoke detectors may not sense fire where smoke cannot reach the detectors such as in chimneys, in or behind walls, on roofs, or on the other side of closed doors. Smoke detectors also may not sense a fire on another level or floor of a building. A second-floor detector, for example, may not sense a first-floor or basement fire.

Particles of combustion or "smoke" from a developing fire may not reach the sensing chambers of smoke detectors because:

- Barriers such as closed or partially closed doors, walls, chimneys, even wet or humid areas may inhibit particle or smoke flow.
- Smoke particles may become "cold," stratify, and not reach the ceiling or upper walls where detectors are located.
- Smoke particles may be blown away from detectors by air outlets, such as air conditioning vents.
- Smoke particles may be drawn into air returns before reaching the detector.

The amount of "smoke" present may be insufficient to alarm smoke detectors. Smoke detectors are designed to alarm at various levels of smoke density. If such density levels are not created by a developing fire at the location of detectors, the detectors will not go into alarm.

Smoke detectors, even when working properly, have sensing limitations. Detectors that have photoelectronic sensing chambers tend to detect smoldering fires better than flaming fires, which have little visible smoke. Detectors that have ionizing-type sensing chambers tend to detect fast-flaming fires better than smoldering fires.

Because fires develop in different ways and are often unpredictable in their growth, neither type of detector is necessarily best and a given type of detector may not provide adequate warning of a fire.

Smoke detectors cannot be expected to provide adequate warning of fires caused by arson, children playing with matches (especially in bedrooms), smoking in bed, and violent explosions (caused by escaping gas, improper storage of flammable materials, etc.).

Heat detectors do not sense particles of combustion and alarm only when heat on their sensors increases at a predetermined rate or reaches a predetermined level. Rate-of-rise heat detectors may be subject to reduced sensitivity over time. For this reason, the rate-of-rise feature of each detector should be tested at least once per year by a qualified fire protection specialist. Heat detectors are designed to protect property, not life.

IMPORTANT! Smoke detectors must be installed in the same room as the control panel and in rooms used by the system for the connection of alarm transmission wiring, communications, signaling, and/or power. If detectors are not so located, a developing fire may damage the alarm system, compromising its ability to report a fire.

Audible warning devices such as bells, horns, strobes, speakers and displays may not alert people if these devices are located on the other side of closed or partly open doors or are located on another floor of a building. Any warning device may fail to alert people with a disability or those who have recently consumed drugs, alcohol, or medication. Please note that:

- An emergency communication system may take priority over a fire alarm system in the event of a life safety emergency.
- Voice messaging systems must be designed to meet intelligibility requirements as defined by NFPA, local codes, and Authorities Having Jurisdiction (AHJ).
- Language and instructional requirements must be clearly disseminated on any local displays.
- Strobes can, under certain circumstances, cause seizures in people with conditions such as epilepsy.
- Studies have shown that certain people, even when they hear a fire alarm signal, do not respond to or comprehend the meaning of the signal. Audible devices, such as horns and bells, can have different tonal patterns and frequencies. It is the property owner's responsibility to conduct fire drills and other training exercises to make people aware of fire alarm signals and instruct them on the proper reaction to alarm signals.
- In rare instances, the sounding of a warning device can cause temporary or permanent hearing loss.

A life safety system will not operate without any electrical power. If AC power fails, the system will operate from standby batteries only for a specified time and only if the batteries have been properly maintained and replaced regularly.

Equipment used in the system may not be technically compatible with the control panel. It is essential to use only equipment listed for service with your control panel.

Telephone lines needed to transmit alarm signals from a premises to a central monitoring station may be out of service or temporarily disabled. For added protection against telephone line failure, backup radio transmission systems are recommended.

The most common cause of life safety system malfunction is inadequate maintenance. To keep the entire life safety system in excellent working order, ongoing maintenance is required per the manufacturer's recommendations, and UL and NFPA standards. At a minimum, the requirements of NFPA 72 shall be followed. Environments with large amounts of dust, dirt, or high air velocity require more frequent maintenance. A maintenance agreement should be arranged through the local manufacturer's representative. Maintenance should be scheduled as required by National and/or local fire codes and should be performed by authorized professional life safety system installers only. Adequate written records of all inspections should be kept.

Limit-D2-2016

Installation Precautions

Adherence to the following will aid in problem-free installation with long-term reliability:

WARNING - Several different sources of power can be connected to the fire alarm control panel. Disconnect all sources of power before servicing. Control unit and associated equipment may be damaged by removing and/or inserting cards, modules, or interconnecting cables while the unit is energized. Do not attempt to install, service, or operate this unit until manuals are read and understood.

CAUTION - System Re-acceptance Test after Software

Changes: To ensure proper system operation, this product must be tested in accordance with NFPA 72 after any programming operation or change in site-specific software. Re-acceptance testing is required after any change, addition or deletion of system components, or after any modification, repair or adjustment to system hardware or wiring. All components, circuits, system operations, or software functions known to be affected by a change must be 100% tested. In addition, to ensure that other operations are not inadvertently affected, at least 10% of initiating devices that are not directly affected by the change, up to a maximum of 50 devices, must also be tested and proper system operation verified.

This system meets NFPA requirements for operation at 0-49° C/ 32-120° F and at a relative humidity (non condensing) of 85% at 30°C (86°F) per NFPA, and 93% ± 2% at 32°C ± 2°C (89.6°F ± 1.1°F) per ULC. However, the useful life of the system's standby batteries and the electronic components may be adversely affected by extreme temperature ranges and humidity. Therefore, it is recommended that this system and its peripherals be installed in an environment with a normal room temperature of 15-27° C/60-80° F.

Verify that wire sizes are adequate for all initiating and indicating device loops. Most devices cannot tolerate more than a 10% I.R. drop from the specified device voltage.

Like all solid state electronic devices, this system may operate erratically or can be damaged when subjected to lightning induced transients. Although no system is completely immune from lightning transients and interference, proper grounding will reduce susceptibility. Overhead or outside aerial wiring is not recommended, due to an increased susceptibility to nearby lightning strikes. Consult with the Technical Services Department if any problems are anticipated or encountered.

Disconnect AC power and batteries prior to removing or inserting circuit boards. Failure to do so can damage circuits.

Remove all electronic assemblies prior to any drilling, filing, reaming, or punching of the enclosure. When possible, make all cable entries from the sides or rear. Before making modifications, verify that they will not interfere with battery, transformer, or printed circuit board location.

Do not tighten screw terminals more than 9 in-lbs. Over-tightening may damage threads, resulting in reduced terminal contact pressure and difficulty with screw terminal removal.

This system contains static-sensitive components. Always ground yourself with a proper wrist strap before handling any circuits so that static charges are removed from the body. Use static suppressive packaging to protect electronic assemblies removed from the unit.

Follow the instructions in the installation, operating, and programming manuals. These instructions must be followed to avoid damage to the control panel and associated equipment. FACP operation and reliability depend upon proper installation.

Precau-D1-9-2005

FCC Warning

WARNING: This equipment generates, uses, and can radiate radio frequency energy and if not installed and used in accordance with the instruction manual may cause interference to radio communications. It has been tested and found to comply with the limits for class A computing devices pursuant to Subpart B of Part 15 of FCC Rules, which is designed to provide reasonable protection against such interference when devices are operated in a commercial environment. Operation of this equipment in a residential area is likely to cause interference, in which case the user will be required to correct the interference at his or her own expense.

Canadian Requirements

This digital apparatus does not exceed the Class A limits for radiation noise emissions from digital apparatus set out in the Radio Interference Regulations of the Canadian Department of Communications.

Le présent appareil numérique n'émet pas de bruits radioélectriques dépassant les limites applicables aux appareils numériques de la classe A prescrites dans le Règlement sur le brouillage radioélectrique édicté par le ministère des Communications du Canada.

Farenhyt™ is a trademark; and eVance®, Honeywell®, Silent Knight® and SWIFT® are registered trademarks of Honeywell International Inc. Microsoft® and Windows® are registered trademarks of the Microsoft Corporation. Chrome™ and Google™ are trademarks of Google Inc. Firefox® is a registered trademark of The Mozilla Foundation.

©2018 by Honeywell International Inc. All rights reserved. Unauthorized use of this document is strictly prohibited.

Software Downloads

In order to supply the latest features and functionality in fire alarm and life safety technology to our customers, we make frequent upgrades to the embedded software in our products. To ensure that you are installing and programming the latest features, we strongly recommend that you download the most current version of software for each product prior to commissioning any system. Contact Technical Support with any questions about software and the appropriate version for a specific application.

Documentation Feedback

Your feedback helps us keep our documentation up-to-date and accurate. If you have any comments or suggestions about our online Help or printed manuals, you can email us.

Please include the following information:

- Product name and version number (if applicable)
- Printed manual or online Help
- Topic Title (for online Help)
- Page number (for printed manual)
- Brief description of content you think should be improved or corrected
- Your suggestion for how to correct/improve documentation

Send email messages to:

FireSystems.TechPubs@honeywell.com

Please note this email address is for documentation feedback only. If you have any technical issues, please contact Technical Services.

Contents

Section 1: Introduction	12
1.1: Overview of Basic System.....	12
1.1.1: Hardware Features	12
1.1.2: Network System Hardware Features	12
1.1.3: Software Features	12
1.1.4: IFP-2100ECS Features	13
1.1.5: Terms Used in this Manual.....	13
1.2: Compatible Products.....	13
Section 2: Agency Listings, Approvals, and Requirements.....	16
2.1: Federal Communications Commission (FCC).....	16
2.2: Underwriters Laboratories (UL).....	17
2.2.1: Requirements for All Installations.....	17
2.2.2: Requirements for Central Station Fire Alarm Systems	17
2.2.3: Requirements for Local Protected Fire Alarm Systems	17
2.2.4: Requirements for Remote Station Protected Fire Alarm Systems.....	17
2.2.5: Requirements for the Installation of Carbon Monoxide (CO) Detection and Warning Equipment, NFPA 720.....	17
2.2.6: NFPA Requirements.....	17
Section 3: Before You Begin Installation	20
3.1: Inventory.....	20
3.2: Environmental Specifications.....	20
3.3: Software Downloads.....	20
3.4: Electrical Specifications	20
3.5: Wiring Specifications.....	22
3.6: Board Assembly Diagram.....	24
3.7: Calculating Current Draw and Standby Battery	24
3.7.1: Current Draw Worksheet Requirements.....	25
3.7.2: Current Draw Worksheet for IDP SLC Devices.....	25
3.7.3: Current Draw Worksheet for SK SLC Devices.....	28
3.7.4: Current Draw Worksheet for SD SLC Devices.....	32
3.7.5: Maximum Battery Standby Load.....	34
Section 4: Control Panel Installation	36
4.1: Mounting the Control Panel Cabinet	36
4.1.1: Preventing Water Damage.....	36
4.1.2: Removing the IFP-2100/ECS Assembly from the Housing.....	36
4.1.3: Ethernet Connection	36
4.2: AC Power Connection	37
4.3: Battery Power	37
4.3.1: Battery Accessory Cabinets.....	38
Installing the RBB or AB-55 Accessory Cabinet and Batteries	38
4.4: SBUS Wiring	40
4.4.1: Calculating Wiring Distance for SBUS Modules.....	40
4.4.2: Wiring Configurations.....	42
4.5: RA-2000 Remote Annunciator Installation	43
4.5.1: Mounting the RA-2000.....	44
Flush Mounting.....	44
Surface Mounting	45
4.5.2: RA-2000 Connection to the Panel	46
4.5.3: Temporary Programming Display	46
4.6: RA-1000 Remote Annunciator Installation	47
4.6.1: Mounting the RA-1000.....	47
Flush Mounting.....	48
Surface Mounting	50
4.6.2: Model RA-1000 Connection to the Panel.....	50
4.7: RA-100 Remote Annunciator Installation	50
4.7.1: Mounting the RA-100.....	51
Flush Mounting.....	51
Surface Mounting	52
4.7.2: Model RA-100 Connection to the Panel.....	54
4.8: 5815XL Installation	54

4.8.1: 5815XL Connection to the Panel.....	55
4.9: 6815 Installation	56
4.9.1: 6815 Connection to the Panel.....	57
4.10: 5824 Serial/Parallel Interface Module Installation	57
4.10.1: Selecting 5824 Options.....	58
4.11: 5880 LED I/O Module.....	59
4.11.1: 5880 Board Layout	59
4.11.2: FACP Connection.....	60
4.11.3: LED Wiring	60
4.11.4: Dry Contact Wiring	61
4.12: 5865-3 / 5865-4 LED Annunciator Installation	61
4.12.1: FACP Connection.....	62
4.12.2: 5865 Mounting.....	63
4.13: Configuring SBUS Modules.....	63
4.13.1: Assigning SBUS Module IDs.....	63
4.13.2: SBUS Bandwidth Considerations.....	64
4.14: Telephone Connection	64
4.15: Flexputs™ I/O Circuits	65
4.15.1: Conventional Notification Appliance.....	65
Class B Notification Wiring	65
Class A Notification Wiring	66
4.15.2: Conventional Input Switch Circuits.....	66
Class B Inputs	66
Class A Inputs.....	67
4.15.3: Installing 2-Wire Smoke Detectors	67
Installing 2-Wire Class B Smoke Detectors	68
Installing 2-Wire Class A Smoke Detectors	68
4.15.4: Installing 4-Wire Smoke Detectors	68
Installing a Class B 4-Wire Smoke Detectors	68
Installing 4-Wire Class A Smoke Detectors	69
4.15.5: Auxiliary Power Installation.....	69
Door Holder Power.....	70
Constant Power.....	70
Resettable Power.....	70
Sounder Sync Power.....	70
4.16: On-Board Relays (Conventional).....	70
4.16.1: Trouble Relay	70
4.16.2: Programmable Relays.....	70
4.17: Remote Station Applications	71
4.17.1: Keltron Model 3158 Installation.....	71
4.17.2: City Box Connection Using the 5220 Module	71
4.17.3: Using the Addressable Relay Module for City Box Connection.....	72
4.17.4: NFPA 72 Polarity Reversal	72
Using the 5220 Module.....	72
Using the 7644-L8 Module.....	73
4.17.5: Transmitter Activated by Dry Contacts.....	74
Section 5: Networking.....	76
5.1: Network System Hardware Features	76
5.1.1: Networked Sites.....	76
5.1.2: Wiring Options to Connect Networked Panels.....	76
5.2: Model RFP-2100	76
5.3: Network Wiring	76
5.4: SK-NIC Wiring Options	77
5.4.1: Fiber Loop Modules	78
Accessory Mounting Kits	78
5.4.2: SK-NIC Installation.....	78
Unshielded Twisted Pair Wiring between Multiple Panels.....	80
Fiber Optic Multi-Mode Wiring between Multiple Panels.....	81
Fiber Optic and Twisted Pair Wiring between Multiple Panels.....	83
5.5: Setting the Network ID for each Panel.....	84

Section 6: Network Management	86
6.1: Network Diagnostics	86
6.1.1: Ping Panel	86
6.1.2: Data Network Status	86
6.1.3: Voice Network Status	86
6.2: Network Programming	86
6.2.1: Learn Network	86
6.2.2: Edit Network Names	86
6.2.3: Edit Panel ID	86
6.2.4: Computer Access	87
6.2.5: Access Codes	87
Edit Name	88
Edit Access Code	88
Panel Functions	88
6.2.6: Communicator Options	88
Communicator Assignments	88
Communicator Miscellaneous	88
Receiver Configuration	89
Communicator Reporting Table	89
6.3: Voice Options	89
6.3.1: Edit Timers	89
Control Lockout	89
Auto Reset ECS MIC Triggered Event	90
6.3.2: Edit Voice Commands	90
6.4: Sync Network Options	91
6.5: Network Management Quick Reference	92
Section 7: IDP, SK, SD and SWIFT™ SLC Device Installation	96
7.1: List of IDP SLC Devices	96
7.2: List of SK SLC Devices	97
7.3: List of SD SLC Devices	98
7.4: SWIFT Wireless SLC Devices	98
7.5: Maximum Number of SLC Devices	98
7.6: Wiring Requirements for SLC Devices	98
7.6.1: Wire Sizing on 5815XL for SD Devices	99
7.6.2: Wire Sizing for 6815	99
7.6.3: Wiring Requirements for IDP or SK Modules	99
7.6.4: Wiring 5815XL or 6815 in Style 6 & 7 (Class A) Configuration	100
7.7: Addressing IDP or SK SLC Devices	101
7.8: Wiring SD Detectors	101
7.9: Addressing SD Devices	102
7.9.1: SLC Devices with DIP Switches	103
7.10: Wiring the WIDP-WGI or SK-WGI	103
7.10.1: Power Connections for the Gateway	104
Section 8: Programming Overview	106
8.1: JumpStart® AutoProgramming	106
8.1.1: Input Points	106
8.1.2: Output Points	106
8.1.3: Running JumpStart® AutoProgramming	106
8.2: Mapping Overview	107
8.2.1: Input Point Mapping	108
8.2.2: Output Circuit Mapping	109
8.2.3: Event Mapping	109
8.2.4: Mapping LED Points	113
8.2.5: Mapping LED Points for a Networked System	114
8.3: Programming Using the HFSS Honeywell Fire Software Suite	114
8.4: Programming Using an Annunciator	114
8.4.1: Entering / Exiting Panel Programming	114
Moving through the Menus	115
Selecting Options and Entering Data	115
8.5: Programming Menu Quick Reference	116

Section 9: Programming 128

9.1: UL 864 / UL 2572 Programming Requirements 128

9.2: Modules 128

 9.2.1: Edit Modules 128

 Editing Module ID 129

 Naming Modules 129

 Changing Module Options 129

 9.2.2: Adding a Module 129

 9.2.3: Deleting a Module 129

 9.2.4: View Module List 129

9.3: Zone 130

 9.3.1: Edit Zone 130

 Edit Zone Name 130

 Edit Zone Properties 130

 Zone Accessory Options 132

 9.3.2: View Zone Points 132

9.4: Group 132

 9.4.1: Edit Group 132

 Edit Group Name 132

 Edit Group Properties 132

 9.4.2: View Group Points 133

 9.4.3: Edit OPG Template 133

9.5: Point 134

 9.5.1: Point Programming For 5815XL Module 134

 9.5.2: Point Programming For 6815 Module 136

 9.5.3: Point Programming For Internal or External Power Module (RPS-1000) 139

 9.5.4: Point Programming For 5880/5865 Modules 140

 9.5.5: Point Programming for 5496 141

 9.5.6: Point Programming for ECS-AMP 141

 9.5.7: Point Programming for ECS-VCM, ECS-NVCM or ECS-RVM 142

9.6: System Options 144

 9.6.1: Communication Options 144

 Auto Test Time 144

 Phone Lines 144

 Edit Ethernet 146

 AlarmNet Timers 146

 Phone Line Gains 146

 9.6.2: Daytime/Nighttime Sensitivity 147

 9.6.3: Holiday Days 147

 9.6.4: Time Options 147

 Water Flow Delay 148

 Alarm Verify 148

 AC Report Delay 148

 Change AC Line Frequency 148

 Clock Format (AM/PM or Military) 148

 Auto-Resound (4 or 24 hours) 148

 9.6.5: Miscellaneous Options 148

 Strobes Active when Silenced 149

 Auto Display Events 149

 9.6.6: Daylight Saving Options 149

 Automatic Daylight Saving Adjustment 149

 Daylight Saving Time Start and End 149

 9.6.7: Edit Banner 149

 9.6.8: SLC Family 149

9.7: JumpStart® AutoProgramming 150

9.8: Restore Defaults 150

9.9: Voice Options 150

 9.9.1: VCM Maintenance 150

 9.9.2: Voice Settings 150

 Enable Dual Channel System 151

Section 10: System Operation.....	152
10.1: Default User and Installer Codes.....	152
10.2: Annunciator Description.....	152
10.2.1: LCD Display.....	152
10.2.2: Banner.....	153
Single Key Acknowledge.....	153
10.3: Menu System.....	153
10.3.1: Main Menu Overview.....	153
10.3.2: Using the Menus.....	154
10.4: Basic Operation.....	154
10.4.1: Setting Time and Date.....	154
10.4.2: Disable / Enable a Point.....	154
Disable / Enable NACs by Template.....	154
Disable / Enable NACs by Group.....	154
Disable / Enable Zone Points.....	154
Disable / Enable Point.....	154
Inhibit Output Group.....	154
10.4.3: View Event History.....	154
To clear the event history.....	154
10.4.4: Conduct a Fire Drill.....	154
10.4.5: Conduct an Indicator Test.....	155
10.4.6: Conduct a Walk Test.....	155
10.4.7: Conduct a Communicator Test.....	155
10.4.8: Manual AlarmNet Registration.....	155
10.4.9: Silence Alarms or Troubles.....	155
10.4.10: Reset Alarms.....	156
Reset Communicator.....	156
10.4.11: Check Detector Sensitivity Through Point Status.....	156
10.4.12: View Status of a Point.....	157
10.4.13: View Alarms or Troubles.....	157
10.4.14: System Information.....	157
10.5: Event Priority.....	158
10.5.1: System Control.....	158
10.5.2: System Override.....	158
10.5.3: Event Priority.....	158
10.5.4: Priority Rules.....	159
10.5.5: Other Priority Considerations.....	159
10.6: Operation Mode Behavior.....	159
10.6.1: Multi-Site Annunciator and Multi-Site User Access.....	162
10.7: Releasing Operations.....	162
10.7.1: Single Interlock Zone Releasing.....	164
10.7.2: Double Interlock Zone Releasing.....	164
10.8: Smoke Alarm Verification.....	165
10.9: Function Keys.....	165
10.9.1: Recording an F-Key Macro.....	165
10.9.2: Aborting an F-Key Macro Recording Session.....	166
10.9.3: Erasing an F-Key Macro.....	166
10.9.4: Using a Recorded F-Key Macro.....	166
10.9.5: F-Key Status Event.....	166
10.9.6: F-Key Map Inhibit.....	166
Section 11: Emergency Communication System Operation.....	168
11.1: Overview.....	168
11.2: LOC Functionality.....	168
11.2.1: Keys and LEDs.....	168
ECS Control Key.....	168
ECS Control LED.....	168
ECS Message Keys.....	168
ECS Message LEDs.....	168
Select Keys.....	168
Select Key LEDs.....	169
11.2.2: Gaining ECS Control.....	169

LOC Priority	169
LOC Lockout	169
User Profile Access Control	170
11.2.3: Manual ECS	170
Switching between Microphone Mode and Message Mode	170
Activating Output Groups Dynamically	170
11.2.4: Microphone Mode	170
11.2.5: Message Mode	170
11.2.6: Custom ECS Event	170
11.2.7: Passing ECS Control	171
11.2.8: Exit ECS Control Menu	171
11.2.9: Relinquish ECS Control	171
11.2.10: ECS Reset	171
11.3: ECS Super User	171
11.4: ECS Point Functionality	172
11.4.1: ECS Point Activations	172
11.4.2: ECS-VCM, ECS-NVCM & ECS-RVM Points	172
11.5: Amplifier Programming	172
11.5.1: Adding an Amplifier	172
11.5.2: Editing an Amplifier	172
11.6: LOC Programming	172
11.6.1: Adding an LOC	173
11.6.2: Editing an LOC	173
LOC Priority	173
LOC Association	173
11.7: Using the Microphone	173
11.7.1: Microphone Functionality	173
11.7.2: Custom ECS Event	173
11.7.3: Fire Page	173
11.7.4: Emergency Page	174
Paging	174
11.8: Recording Custom Messages	174
11.8.1: Recording Messages 1-15 Using Aux Audio Input	175
11.8.2: Recording Messages 1-15 Using the Microphone	177
11.8.3: Erasing User Message	178
11.8.4: Using HFSS Voice Message Load Software	178
11.9: Network Paging	179
Priority	179
Configuration	179
Section 12: Reporting	180
12.1: Receivers Compatible with the Control Panel	180
12.2: SIA - IntelliKnight / IFP-2100/ECS Panels PI Modifier Reporting:	190
12.3: SIA – IFP-2100/ECS Panel Communicator:	191
Section 13: Testing and Troubleshooting	194
13.1: Troubleshooting	194
13.2: Periodic Testing and Maintenance	195
13.3: Event History	195
13.4: Built-in Troubleshooting and Testing Tools	195
13.4.1: SLC Device Locator	195
13.4.2: SLC Multiple Device Locator	196
13.4.3: I/O Point Control	196
13.4.4: Earth Fault Resistance	197
Section 14: Installation Records	198
14.1: Detector and Module Point Record	198
Appendix A: Compatible Devices	202
A.1: Notification Appliances	202
A.2: Two Wire Detectors	210
A.3: Four-Wire Smoke Detectors/Devices (UL Listed)	211
A.4: Door Holders (UL Listed)	212
A.5: Relays (UL Listed)	212

A.6: Compatible 520Hz Signaling Speakers	213
A.7: Compatible 520Hz Low Frequency Bases.....	213
Appendix B: Editing Text Using the Built-In Programmer.....	214
B.1: Characters Used for Editing Text.....	214
B.2: Example Name Edit	214
Appendix C: Cadence Patterns	216
Appendix D: Expanded Receiver/Panel Relationship	218
Panel Security 1	
1.1: Panel installation / maintenance security checklist	1
Manufacturer Warranties and Limitation of Liability	
Model IFP-2100 Basic Operating Instructions	
Model IFP-2100ECS Basic Operating Instructions	

Section 1: Introduction

The IFP-2100 (red) / IFP-2100B (black) and IFP-2100ECS (red) / IFP-2100ECSB (black) are analog addressable fire alarm control panels (FACP), that meets the requirements of UL 864. The IFP-2100ECS is an analog addressable fire control system combined with an Emergency Communication System that meet the requirements for Mass Notification as described in UL 864 and UL 2572.

The RFP-2100 (red) or RFP-2100B (black) are the same as the IFP-2100 without the display. The RFP-2100 is used in a networked system where there is at least one IFP-2100/ECS in the system. When using the RFP-2100 as a stand alone local unit, one LCD annunciator must be connected, and the annunciator must be wired in conduit within 20' of the RFP-2100.



NOTE: All references to IFP-2100 or IFP-2100ECS within this manual are applicable to the IFP-2100B and IFP-2100ECSB. All References to the IFP-2100HV are applicable to the IFP-2100HVB, RFP-2100HV, RFP-2100HVB, IFP-2100ECSHV and the IFP-2100ECSHVB.

NOTE: All references to RFP-2100 within this manual are applicable to RFP-2100B.

1.1 Overview of Basic System

The IFP-2100/ECS base system is packaged as an assembled stack of 3 circuit boards mounted to an aluminum housing.

1.1.1 Hardware Features

- The basic IFP-2100/ECS panel contains one built in signaling line circuit (SLC), which supports up to 159 IDP or SK sensors and 159 IDP or SK modules or 127 SD SLC devices. Additional SLC loops can be added to increase overall point capacity.
 - Additional 6815 SLC expanders supports 159 IDP or SK sensors and 159 IDP or SK modules for a maximum of 2100 points per IFP-2100/ECS control panel.
 - Additional 5815XL SLC expander supports only SD Protocol for a maximum of 2032 points per IFP-2100/ECS control panel.
 - 9.0A of output power is available through 8 sets of terminals for notification and auxiliary applications. Each circuit is power limited per UL 864 and can source up to 3.0A (total output power must not exceed 9.0A). The constant auxiliary power load must not exceed 6.0A for normal standby.
 - Built-in dual phone line, digital alarm communicator/transmitter (DACT), IP or optional cellular technologies.
 - Reports events to central station by point or by zone.
 - UL Listed for pre-action and deluge releasing systems.
 - Dedicated Form C trouble relay and two general purpose Form C programmable relays.
 - Can be used with RA-2000s¹, RA-1000s² or RA-100s² in any combination.
 - Supports the 5865-3, 5865-4, and 5880 LED annunciators¹. See sections 4.11 and Section 4.12 for additional information on these models.
 - Printing of event log available through the Model 5824¹ serial/parallel printer interface module.
 - Supports conventional 2-wire & 4-wire detectors using the 8 Flexput™ circuits or SLC zone modules.
 - 999 software zones, 999 output groups.
 - Add four notification/auxiliary power circuits with each 5496 Intelligent Power Module.
 - Add six Flexput™ circuits with each RPS-1000 Remote Power Supply.
1. The system can have a maximum of 63 SBUS devices in any combination.
 2. RA-1000 and RA-100 can have a maximum of 31 devices used.

1.1.2 Network System Hardware Features

- The default network setup can contain up to 32- IFP-2100/ECS / RFP-2100 panels connected.
- Network support for up to 32 Sites.
- Each building is referred to as a “site”.
- Panels can be interconnected using CLASS B or CLASS A topology.
- To network panels together use the SK-NIC network card. Copper wire or fiber optic cable panel connectivity can be used within the same networked system.
- The network architecture provides true peer to peer capability allowing network survivability for all hardware that remains operational in the event of partial system failure.

1.1.3 Software Features

- Advanced analog smoke detector features:
 - Three sensitivity settings (high, medium, low)
 - Automatic drift compensation
 - Maintenance alert region
 - Point status meets calibrated smoke test requirements for NFPA 72
 - Automatic day/night sensitivity adjustment
- “JumpStart AutoProgramming” feature for easy programming
- Non-volatile event history stores 1000 events per panel

- A choice of output patterns available for notification outputs, including ANSI 3.41 temporal signal
- Built-in synchronization appliance support for AMSECO, Gentex[®], System Sensor[®], and Wheelock[®]

1.1.4 IFP-2100ECS Features

- 15 Recordable one minute messages that can be mapped to eight ECS buttons.
- ECS messages can be selected as priority over fire.
- Support of up to 15 ECS-LOCs.
- Programmable trigger inputs from an external source, such as a Monaco system, to either the ECS-VCM, ECS-NVCM, ECS-RVM, 5880, any SLC input module or Flexput module.
- Support for up to 16 SBUS addressable amplifiers using a combination of ECS-50W, ECS-125W, ECS-INT50W or ECS-DUAL50W for a maximum of 2000 watts per system and up to 128 mappable speaker circuits.
- Support for dual channel and backup audio using the ECS-DUAL50W amplifier and ECS-50WBU back-up amplifier.
- Single enclosure for both Fire and Emergency Control System components.
- Support for one ECS-VCM or ECS-NVCM.

1.1.5 Terms Used in this Manual

The following terminology is used with the above mentioned control panels:

Term	Description
SLC	Signaling line circuit
Module	The term module is used for all hardware devices except for SLC addressable devices and notification appliances. This includes the IFP-2100/ECS/RFP-2100 panels itself and the built-in power supply. It also refers to any (optional) 5815XL or 6815 SLC expansion modules.
Input Point	An addressable sensing device, such as a smoke, heat detector or a contact monitor device
Input Zone	A protected area made up of input points
Output Point (or "Output Circuit")	A notification point or circuit for notification appliances. Relay circuits and auxiliary power circuits are also considered output points
Group (or "Output Group" or OPG)	A group of output points. Operating characteristics are common to all output points in a group
Mapping	Mapping is the process of specifying which outputs are activated when certain events occur in the system. Section 8.2 explains mapping in detail
Networking	Up to 32 panels can be networked.
Network System	Consist of any combination of 32 panels of these model numbers: IFP-75, IFP-300, IFP-300ECS, IFP-2100, IFP-2100ECS, RFP-2100, IFP-2000, or IFP-2000ECS
ECS	Emergency Communication System
SWIFT	Smart Wireless Integrated Fire Technology

1.2 Compatible Products

Table 1.1 lists the products available for use with the IFP-2100/ECS.

Type of Device	Model	Description
IDP Addressable SLC Devices	See Section 7.1 for a list of compatible devices	
SK Addressable SLC Devices	See Section 7.2 for a list of compatible devices	
SD Addressable SLC Devices	See Section 7.3 for a list of compatible devices	
SWIFT Wireless SLC Devices	See Section 7.4 for a list of compatible devices	
Other Modules	5824 Serial/Parallel Printer Interface Module	Allows a printer to be attached for the system for on-site logging. Four maximum per system.
	5815XL (Rev H or above) SLC Expander	Each 5815XL allows up to 127 SD devices to be added to the system. The number of 5815XLs that can be added to the system is limited only by the maximum number of SBUS devices. However the maximum SD point count is limited to 2032 per panel. 5815XL will only support SD protocol devices

Table 1.1 IFP-2100/ECS Compatible Products

Type of Device	Model	Description	
Other Modules (con't)	6815 SLC EXPANDER	Each 6815 supports up to 159 IDP or SK sensors and 159 IDP or SK modules. The maximum point count for IDP or SK devices is limited to 2100 per panel. 6815 supports System Sensor devices (IDP or SK)	
	RFP-2100 Remote Fire Panel w/no display	Same operation as IFP-2100/ECS without display	
	5824 Serial/Parallel Printer Interface Module	Allows a printer to be attached for the on-site event logging. Maximum of four 5824s per control panel.	
	RPS-1000 (Rev F or higher) Intelligent Power Module	Provides additional power, six Flexput™ circuits, and two Form C relays. See <i>Model RPS-1000 Installation Instructions P/N 151153</i> .	
	5496 (Rev F or above) NAC Expander	Provides four additional Notification Appliance Circuits/Auxiliary power	
	RA-2000 LCD Alarm Annunciator	4x 40 LCD annunciator. Same operation, similar appearance as on-board annunciator. Any combination of supported annunciators for a max of 63.	
	RA-1000 LCD Alarm Annunciator	4x 20 LCD annunciator. Any combination of supported annunciators for a max of 31.	
	RA-100 LCD Alarm Annunciator	4x 20 LCD annunciator. Any combination of supported annunciators for a max of 31.	
	5865-3 and 5865-4 LED Annunciator	LED annunciator can display up to 30 LEDs (15 red and 15 yellow). 5865-4 has key switches for silence and reset, and a system trouble LED.	
	5880 (Rev C or above) LED I/O Module	Driver for up to 40 LEDs. Interfaces with customized annunciator boards. In addition, the 5880 has eight generic switch input points.	
	5883 General Purpose Relay Module	Provides 10 Form C relays. Designed to be driven by the 5880. Up to four, 5883s can be used with each 5880 module.	
	ECS-VCM	Voice Control Module	Refer to the ECS-Series installation manual PN 151455 for more info on these accessories.
	ECS-NVCM	Network Voice Control Module	
	ECS-SW24	24 Switch expander	
	ECS-50W	50 watt audio amplifier	
	ECS-125W	125 watt audio amplifier	
	ECS-INT50W	50 watt internal amplifier	
	ECS-DUAL50W	Dual Channel amplifier	
	ECS-50WBU	Backup daughter card	
	ECS-CE4	Provides 4 additional audio circuits for the ECS-50W or the ECS-125W	
ECS-RVM	Remote Voice Microphone		
SK-NIC	Network Interface Card		
ECS-LOC2100	Local Operating Console	Refer to LS10188-0001SK-E	
Wireless	WIDP-WGI	Wireless Gateway	Refer to the <i>SWIFT wireless Installation Manual</i> P/N LS10036-FH-E for more information on these accessories.
	WIDP-PHOTO	Wireless Photoelectric Smoke Detector w/ 4" base	
	WIDP-ACCLIMATE	Wireless Multi criteria photoelectric smoke detector with thermal (135°F) w/ 4" base	
	WIDP-HEAT-ROR	Wireless Heat Rate of Rise Detector 135° fixed w/4" base	
	WIDP-HEAT	Wireless Heat, 135° fixed Heat Detector w/4" base	
	WIDP-MONITOR	Wireless Addressable Monitor module	
	WIDP-RELAY	Wireless Addressable Relay module	
	B210W	6" wireless base	

Table 1.1 IFP-2100/ECS Compatible Products

Type of Device	Model	Description	
Wireless (cont.)	WSK-WGI	Wireless Gateway	Refer to the <i>SWIFT wireless Installation Manual</i> P/N LS10036-SK-E for more information on these accessories.
	WSK-PHOTO	Wireless photo with 4" base	
	WSK-PHOTO-T	Wireless Multi criteria photoelectric smoke detector with thermal (135°F) with 4" base	
	WSK-HEAT-ROR	Wireless heat, ROR/ 135° fixed with 4" base	
	WSK-HEAT	Wireless Heat, 135° fixed with 4" base	
	WSK-MONITOR	Wireless monitor module	
	WSK-RELAY	Wireless relay module	
	B210W	6" wireless base	
Misc.	7860 Telephone Cord	RJ31X cord for connecting phone line to the IFP-2100/ECS	
	HFSS Honeywell Fire Software Suite	For communication and panel programming with a Windows-based computer. Enables remote viewing of detector status and event history.	
	RBB	Remote Battery Box for mounting backup batteries up to 35AH that are too large to fit into the main control panel cabinet. Dimensions: 16" W x 10" H x 6" D (40.64 cm W x 25.4 cm H x 15.24 cm D)	
	AB-55	Remote Battery Box for mounting backup batteries up to 55AH that are too large to fit into the main control panel cabinet. Dimensions: 20" W x 12" H x 7.5" D (50.8 cm W x 30.48 cm H x 19.05 cm D)	
	CELL-MOD	Cellular board with Plastic Enclosure	Refer to the CELL-CAB-SK/CELL-MOD <i>Installation Manual</i> P/N LS10182-001SK-E for more information.
	CELL-CAB-SK	Cellular board with Metal Enclosure. Lock & key	

Table 1.1 IFP-2100/ECS Compatible Products

Section 2: Agency Listings, Approvals, and Requirements

2.1 Federal Communications Commission (FCC)

1. The following information must be provided to the telephone company before the IFP-2100/ECS can be connected to the phone lines:

A	Manufacturer:	Honeywell
B	Model Number:	IFP-2100; IFP-2100ECS
C	FCC registration number:	US: HS9AL10A2100
	Ringer equivalence:	1.0A
D	Type of jack:	RJ31X
E	Facility Interface Codes:	Loop Start: 02LS2
F	Service Order Code:	9.0F

Table 2.1

This equipment complies with Part 68 of the FCC rules and the requirements adopted by ACTA. On the inside cover of this equipment is a label that contains, among other information, a product identifier. If requested, this information must be provided to the telephone company.

A plug and jack used to connect this equipment to the premises wiring and telephone network must comply with the applicable FCC Part 68 rules and requirements adopted by the ACTA. A compliant telephone cord (not provided) and modular jack must be utilized with this product. It is designed to be used with a modular jack that is also compliant.

The REN (ringer equivalence number) provided on this installation sheet is used to determine the number of devices that may be connected to the public switched telephone network. This number must not exceed 5.0. Since this product has an REN of 1.0A, the number of devices is limited. The REN number is embedded in the FCC registration number as 10A.

If the IFP-2100/IFP-2100HV/ IFP-2100ECS or IFP-2100ECSHV causes harm to the telephone network, the telephone company will notify you in advance that the temporarily discontinuance of service may be required. But if advance notice is not practical, the telephone company will notify the customer as soon as possible. Also, you will be advised of your right to file a complaint with the FCC if you believe it is necessary.

The telephone company may make changes in its facilities, equipment, operations or procedures that could affect the operation of the equipment. If this happens the telephone company will provide advance notice in order for you to make necessary modifications to maintain uninterrupted service.

If trouble is experienced with the IFP-2100/IFP-2100HV/ IFP-2100ECS or IFP-2100ECSHV, for repair or warranty information, please contact Honeywell Farenhyt Series at 1-800-328-0103 or www.farenhyt.com. If the equipment is causing harm to the telephone network, the telephone company may request that you disconnect the IFP-2100/IFP-2100HV/ IFP-2100ECS or IFP-2100ECSHV until the problem has been resolved.

This product cannot be adjusted or repaired in the field. It must be returned to the factory for service.

This equipment is not designed for use with party line service. Connection to party line service is subject to state tariffs. You may contact the state public utility commission, public service commission or corporation commission for information.

Since the IFP-2100/IFP-2100HV/ IFP-2100ECS or IFP-2100ECSHV are commercial fire alarm panels, it must be connected upstream of all other equipment utilizing the phone lines. If you have questions about the installation, contact your telephone company or a qualified installer.



WARNING: THIS DEVICE HAS BEEN VERIFIED TO COMPLY WITH FCC RULES PART 15. OPERATION IS SUBJECT TO THE FOLLOWING CONDITIONS: (1) THIS DEVICE MAY NOT CAUSE RADIO INTERFERENCE, AND (2) THIS DEVICE MUST ACCEPT ANY INTERFERENCE RECEIVED, INCLUDING INTERFERENCE THAT MAY CAUSE UNDESIRE OPERATION.

Caution - To ensure proper operation, this equipment must be installed according to the enclosed installation instructions. To verify that the equipment is operating properly and can successfully report an alarm, this equipment must be tested immediately after installation, and periodically thereafter, according to the enclosed test instructions.

Caution - In order for “alarm dialing equipment” to be able to seize the phone line to report an alarm or other event when other customer equipment (telephone, answering system, computer modem, etc.) connected to the same line is in use, “alarm dialing equipment” must be connected to a properly installed RJ31X jack. The RJ31X jack must be connected in series with, and ahead of, all other equipment attached to the same phone line. Series installation of an RJ31X jack is depicted in the figure below. If you have any questions concerning these instructions, you should consult your telephone company or a qualified installer about installing the necessary jack and alarm dialing equipment for you.

2.2 Underwriters Laboratories (UL)

2.2.1 Requirements for All Installations

General requirements are described in this section. When installing an individual device, refer to the specific section of the manual for additional requirements. The following subsections list specific requirements for each type of installation (for example, Central Station Fire Alarm systems, Local Protected Fire Alarm systems, and so on). See Section 10.7 for information on releasing operation.

1. All field wiring must be installed in accordance with NFPA 70 National Electric Code.
2. Use the addressable smoke detectors specified in Section 7.1 (IDP devices), Section 7.2 (SK devices) or Section 7.3 (SD devices), Section 7.4 (SWIFT devices) of this manual and/or conventional detectors listed in the compatibility chart in Appendix A.
3. Use UL listed notification appliances compatible with the IFP-2100/ECS from those specified in Appendix A of this manual.
4. A full system checkout must be performed any time the panel is programmed.

Restricted Options:

- The loss of AC signal is defaulted to 3 hours, but the system still allows settings from 0 - 30 hours. For UL certified installations, this number must be set from 1 to 3 hours.
- The system allows the use of non-latching, spot type smoke detectors. This feature may not be used in commercial applications whereby a general alarm is sounded. It is intended for elevator recall, door holding applications, and hotel/motel room applications.
- The system allows the Alarm Verification confirmation time to be set from 60 to 250 seconds. For UL certified installations the setting must be a minimum of 60 seconds.
- The systems allows the Auto-resound time to be set to 24 or 4 hours. For UL certified installations that are utilizing SWIFT devices, the value must be set to 4 hours.
- Call forwarding shall not be used.
- When two count is used: detector spacing shall be cut in half, you shall not use the alarm verification feature, and no delay shall be used.
- P.A.S. (positive alarm sequence) feature shall be used only with automatic detectors.

2.2.2 Requirements for Central Station Fire Alarm Systems

1. Use both phone lines. Enable phone line monitors for both lines.
2. You must program a phone number and a test time so that the IFP-2100/ECS shall automatically initiate and complete a test signal transmission sequence to its associated receiver at least once every 6 hrs.
3. The AC Loss Hours option must be set from 1-3 hours.
4. If using wired Ethernet or cellular, you must program the corresponding account/subscriber ID and a test time so that the FACP shall automatically initiate a test signal transmission sequence to its associated receiver at least once every 6hrs.

2.2.3 Requirements for Local Protected Fire Alarm Systems

At least one UL listed supervised notification appliance must be used.

2.2.4 Requirements for Remote Station Protected Fire Alarm Systems

Minimum system requirements are one Honeywell addressable initiating device and wither a 5220, Keltron 3158 or the built-in Digital Alarm Communicator Transmitter (DACT).

1. Do not exceed the current draw load restrictions shown in Section 3.7.
2. The AC Loss Hours option must be set from 1-3 hours.

2.2.5 Requirements for the Installation of Carbon Monoxide (CO) Detection and Warning Equipment, NFPA 720

When using carbon monoxide detection the system must be monitored by a Supervising Station.

2.2.6 NFPA Requirements

The following is the minimum configuration to meet the NFPA requirements.

Model/Module	Description	Local	Releasing	Auxiliary	Remote Station	Central Station
021000	Motherboard	Y	Y	Y	Y	Y
RFP-2100	Remote unit	O (1)	O (1)	O (1)	O (1)	O (1)
Cell-Mod	Transmitter	O	O	O	O	O
5220	Rev Pol Mod	O	O	Y	Y	O
5815XL	SLC Exp	O	O	O	O	O
5824	Serial card	O	O	O	O	O
7644	Rev pol mod	O	O	N	Y	O
6815	SLC Exp	O	O	O	O	O

Table 2.2 NFPA Requirements for IFP-2100 or RFP-2100

Model/Module	Description	Local	Releasing	Auxiliary	Remote Station	Central Station
SK-NIC	Network card	O	O	O	O	O
SK-FML	Fiber module	O	O	O	O	O
SK-FSL	Fiber module	O	O	O	O	O
IFP-2100CB	Enclosure	Y	Y	Y	Y	Y
IFP-2100CBC	Enclosure	Y	Y	Y	Y	Y
RFP-2100CB	Enclosure	Y	Y	Y	Y	Y
RFP-2100BCB	Enclosure	Y	Y	Y	Y	Y
6861BIA/6861 GIA (5)	annunciator	Y	Y	Y	Y	Y
Y = YES, N = NO, O = OPTIONAL						

Table 2.2 NFPA Requirements for IFP-2100 or RFP-2100

Model/Module	Description	Local	Releasing	Auxiliary	Remote Station	Central Station	Mass Notification (In-Building)	Emergency	EVAC
021000	Motherboard	Y	Y	Y	Y	Y	Y	Y	Y
6861BIA/6861GIA	Annunciator boards	Y	Y	Y	Y	Y	Y	Y	Y
ECS-EMG	LED / switch card	Y	Y	Y	Y	Y	Y	Y	Y
5220	Direct Conn Module	O	O	Y	Y	O	N	O	N
5496	Indicating Circuit Expander	O	O	O	O	O	O	O	O
5815XL	SLC Expander	O	O	O	O	O	O	O	O
5824	Serial/Parallel Interface	O	O	O	O	O	O	O	O
5865-3, -4	Remote Annunciator	O	O	O	O	O	O	O	O
5880	Remote Annunciator	O	O	O	O	O	O	O	O
5883	Relay Module	O	O	O	O	O	N	O	N
5895XL	Power Module	O	O	O	O	O	O	O	O
7644	EOL device	O	O	N	Y	O	O	O	O
6815	SLC expander	O	O	O	O	O	O	O	O
SK-NIC	Network card	O	O	O	O	O	O	O	O
ECS-NVCM	Network Voice Control Mod	O	O	O	O	O	O	O	O
SK-FML, -FSL	Network Fiber Mod	O	O	O	O	O	O	O	O
IDP-RELAY	Control Mod	O	O	Y	O	O	N	O	N
RPS-1000	Power Expander	O	O	O	O	O	O	O	O
RBB	Accessory cabinet	O	O	O	O	O	O	O	O
IFP-2100ECSCB / IFP-2100ECSBCB	Enclosure	Y	Y	Y	Y	Y	Y	Y	Y
ECS-DUAL50W	Amplifier	N	N	N	N	N	Y ¹	O	Y ¹
ECS-50W	Amplifier	N	N	N	N	N	Y ¹	O	Y ¹

Table 2.3 NFPA Requirements for IFP-2100ECS

Model/Module	Description	Local	Releasing	Auxiliary	Remote Station	Central Station	Mass Notification (In-Building)	Emergency	EVAC
ECS-125W	Amplifier	N	N	N	N	N	Y ¹	O	Y ¹
ECS-SW24	Switch Annunciator	N	N	N	N	N	Y	O	Y
ECS-VCM	Voice Control Module	N	N	N	N	N	Y	O	Y
ECS-RVM	Remote Voice Module	N	N	N	N	N	Y	O	Y
ECS-INT50W	Amplifier	N	N	N	N	N	Y	O	Y
Y = YES, N = NO, O = OPTIONAL 1. At least one of the following amplifiers is required for MNS operation as well as EVAC: ECS-Dual50W, ECS-50, ECS-125 or ECS-INT50W.									

Table 2.3 NFPA Requirements for IFP-2100ECS

Section 3: Before You Begin Installation

This section of the manual is intended to help you plan your tasks to facilitate a smooth installation. Please read this section thoroughly, especially if you are installing a IFP-2100, IFP-2100ECS or RFP-2100 panel for the first time.

3.1 Inventory

When the IFP-2100/ECS shipment is received, check that all the parts have been included in the shipment. The shipment consist of one of each of the following:

- main circuit board with display
- backbox with door.
- plastic bag containing two keys, screws, cables, and ten 4.7K ohm end-of-line resistors
- manual

3.2 Environmental Specifications

It is important to protect the IFP-2100/ECS control panel from water. To prevent water damage, the following precautions should be FOLLOWED when installing the units:

- Intended for indoor use in dry locations only
- Do not mount directly on exterior walls, especially masonry walls (condensation)
- Do not mount directly on exterior walls below grade (condensation)
- Protect from plumbing leaks
- Protect from splash caused by sprinkler system inspection ports
- Do not mount in areas with humidity-generating equipment (such as dryers, production machinery)

When selecting a location to mount the IFP-2100/ECS control panel, the unit should be mounted where it will NOT be exposed to: temperatures outside the range of 0°C- 49°C (32°F-120°F) or humidity exceeding 93% noncondensing.

3.3 Software Downloads

In order to supply the latest features and functionality in fire alarm and life safety technology to our customers, we make frequent upgrades to the embedded software in our products. To ensure that you are installing and programming the latest features, we strongly recommend that you download the most current version of software for each product prior to commissioning any system. Contact Technical Support with any questions about software and the appropriate version for a specific application. Software updates can be found at www.farenhyt.com

3.4 Electrical Specifications

Table 3.1 list the terminal block on the IFP-2100/ECS as well as a description of each individual terminal and their respective electrical rating.

Terminal Label	Description	Rating		Earth Ground Faults	
		Voltage	Current		
B	AC input (hot)	120/240 VAC 50/60 Hz	4.5A for the IFP-2100 2.8A for the IFP-2100HV	N/A	
G	Earth ground	N/A	N/A	N/A	
W	AC input (neutral)	120/240 VAC 50/60 Hz	4.5A for the IFP-2100 2.8A for the IFP-2100HV	N/A	
X	*I/O 1	Flexput™ Circuits	24 VDC	3.0 A notification and auxiliary power circuits 100 mA for initiation circuits	0Ω
O					
X	*I/O 2	Flexput™ Circuits	24 VDC	3.0 A notification and auxiliary power circuits 100 mA for initiation circuits	0Ω
O					
X	*I/O 3	Flexput™ Circuits	24 VDC	3.0 A notification and auxiliary power circuits 100 mA for initiation circuits	0Ω
O					
X	*I/O 4	Flexput™ Circuits	24 VDC	3.0 A notification and auxiliary power circuits 100 mA for initiation circuits	0Ω
O					
X	*I/O 5	Flexput™ Circuits	24 VDC	3.0 A notification and auxiliary power circuits 100 mA for initiation circuits	0Ω
O					

Table 3.1 Terminal Descriptions and Electrical Specifications

Terminal Label		Description	Rating		Earth Ground Faults
			Voltage	Current	
X	*I/O 6	Flexput™ Circuits	24 VDC	3.0 A notification and auxiliary power circuits	0Ω
O				100 mA for initiation circuits	
X	*I/O 7	Flexput™ Circuits	24 VDC	3.0 A notification and auxiliary power circuits	0Ω
O				100 mA for initiation circuits	
X	*I/O 8	Flexput™ Circuits	24 VDC	3.0 A notification and auxiliary power circuits	0Ω
O				100 mA for initiation circuits	
B	SBUS1 OUT	SBUS communication	5 VDC	100 mA	0Ω
A		SBUS power	24 VDC	1.0 A	
+					
-					
B	SBUS1 IN	Used for Class A installations			0Ω
A					
+					
-					
B	SBUS2 OUT	SBUS communication	5 VDC	100 mA	0Ω
A		SBUS power	24 VDC	1.0 A	
+					
-					
B	SBUS2 IN	Used for Class A installations			0Ω
A					
+					
-					
N.C.	RELAY 1	General Purpose Relay 1	24 VDC	2.5 A, resistive	N/A
C					
N.O.					
N.C.	RELAY 2	General Purpose Relay 2	24 VDC	2.5 A, resistive	N/A
C					
N.O.					
N.C.	TROUBLE	Trouble Relay	24 VDC	2.5 A, resistive	N/A
C					
N.O.					
S-	SLC OUT	SLC terminals	32 VDC	150 mA	0Ω
S+					
SC-	SLC IN	Used for Class A installations			0Ω
SC+					
Ring	Phone Line 1 Telco Ring		N/A		0Ω
Tip	Phone Line 1 Telco Tip				
Ring	Phone Line 1 Premises Ring				
Tip	Phone Line 1 Premises Tip				
Ring	Phone Line 2 Telco Ring		N/A		0Ω
Tip	Phone Line 2 Telco Tip				
Ring	Phone Line 2 Premises Ring				
Tip	Phone Line 2 Premises Tip				
+	Battery	Battery Connection	24 VDC	1.12 A	N/A
-					

Table 3.1 Terminal Descriptions and Electrical Specifications

Terminal Label		Description	Rating		Earth Ground Faults
			Voltage	Current	
P3	EXT. Comm Cellular Connection	B	input	55 mA, 95 mA	0Ω
		A			
		S+			
		S-			
P7	Data Network	Used for SK-NIC	24 VDC	21 mA	0Ω
P8	Voice Network	Used For ECS-NVCM	24 VDC	59 mA	0Ω

Table 3.1 Terminal Descriptions and Electrical Specifications

*Regulated for NAC circuits, special application when used for releasing or auxiliary power circuits

3.5 Wiring Specifications

Induced noise (transfer of electrical energy from one wire to another) can interfere with telephone communication or cause false alarms. To avoid induced noise, follow these guidelines:

- Isolate input wiring from high current output and power wiring. Do not pull one multi-conductor cable for the entire panel. Instead, separate the wiring as follows:

High voltage	AC power terminal
SLC loops	SLC In/Out Terminals
POTS reporting input/output	Phone line circuits, Ring Tip Telco, Phone Terminals
Notification circuits	I/01-I/08 Terminals
SBUS	SBUS1 In/Out Terminals, SBUS 2 In/Out Terminals, Cellular communication
Relay circuits	Trouble, Relay 1, Relay 2 Terminals

- Do not pull wires from different groups through the same conduit. If you must run them together, do so for as short a distance as possible or use shielded cable. Connect the shield to earth ground at the panel. You must route high and low voltages separately.
- Route the wiring around the inside perimeter of the cabinet. It should not cross the circuit board where it could induce noise into the sensitive microelectronics or pick up unwanted RF noise from the high speed circuits. See Figure 3.2 for an example.
- High frequency noise, such as that produced by the inductive reactance of a speaker or bell, can also be reduced by running the wire through ferrite shield beads or by wrapping it around a ferrite toroid.

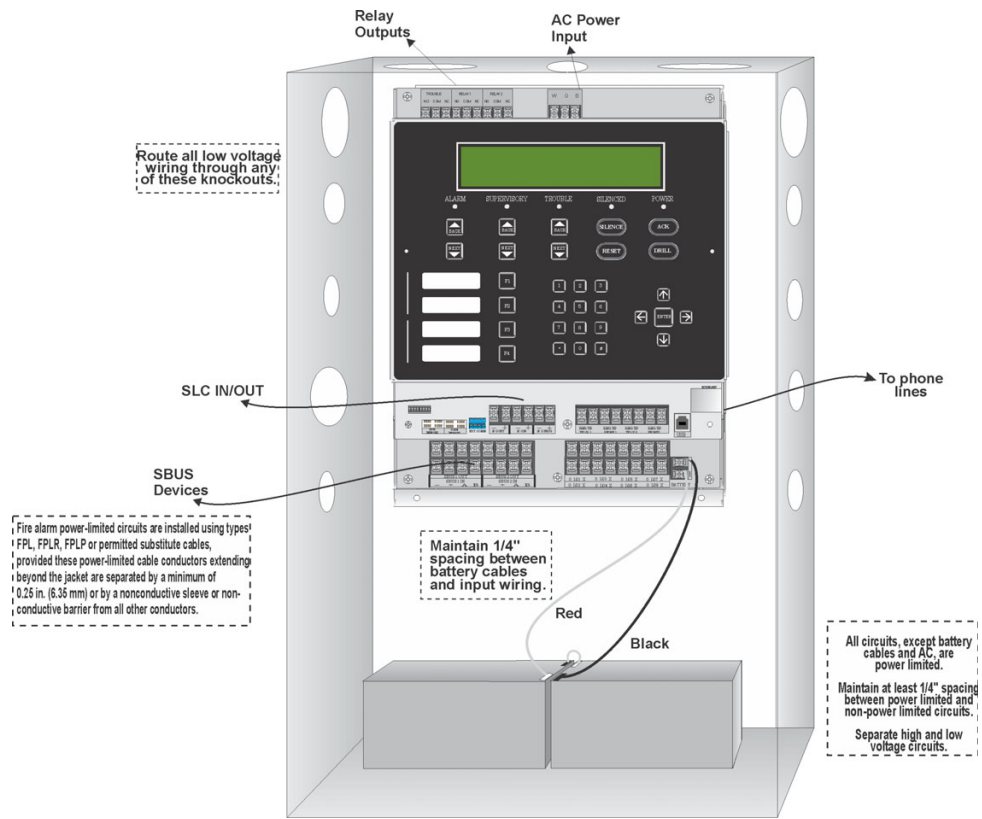

Figure 3.1 Wire Routing Example for IFP-2100

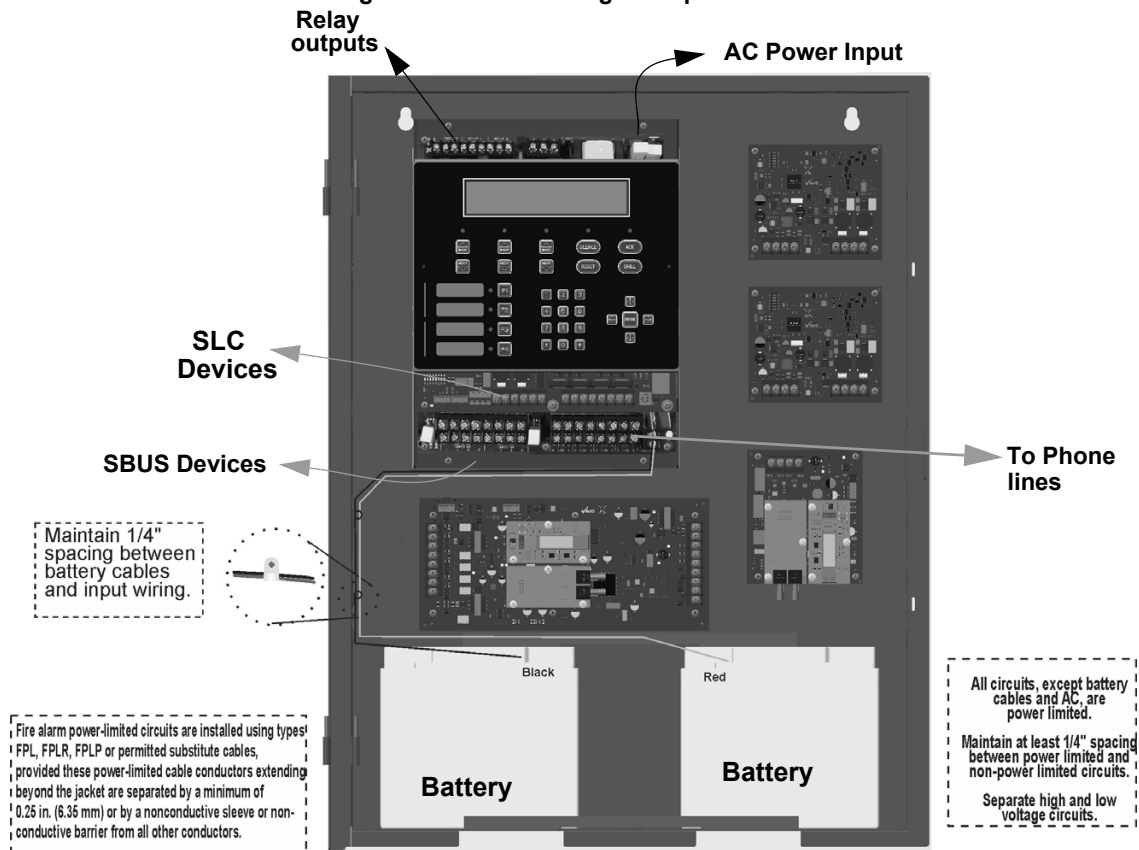

Figure 3.2 Wire Routing Example for IFP-2100ECS

3.6 Board Assembly Diagram

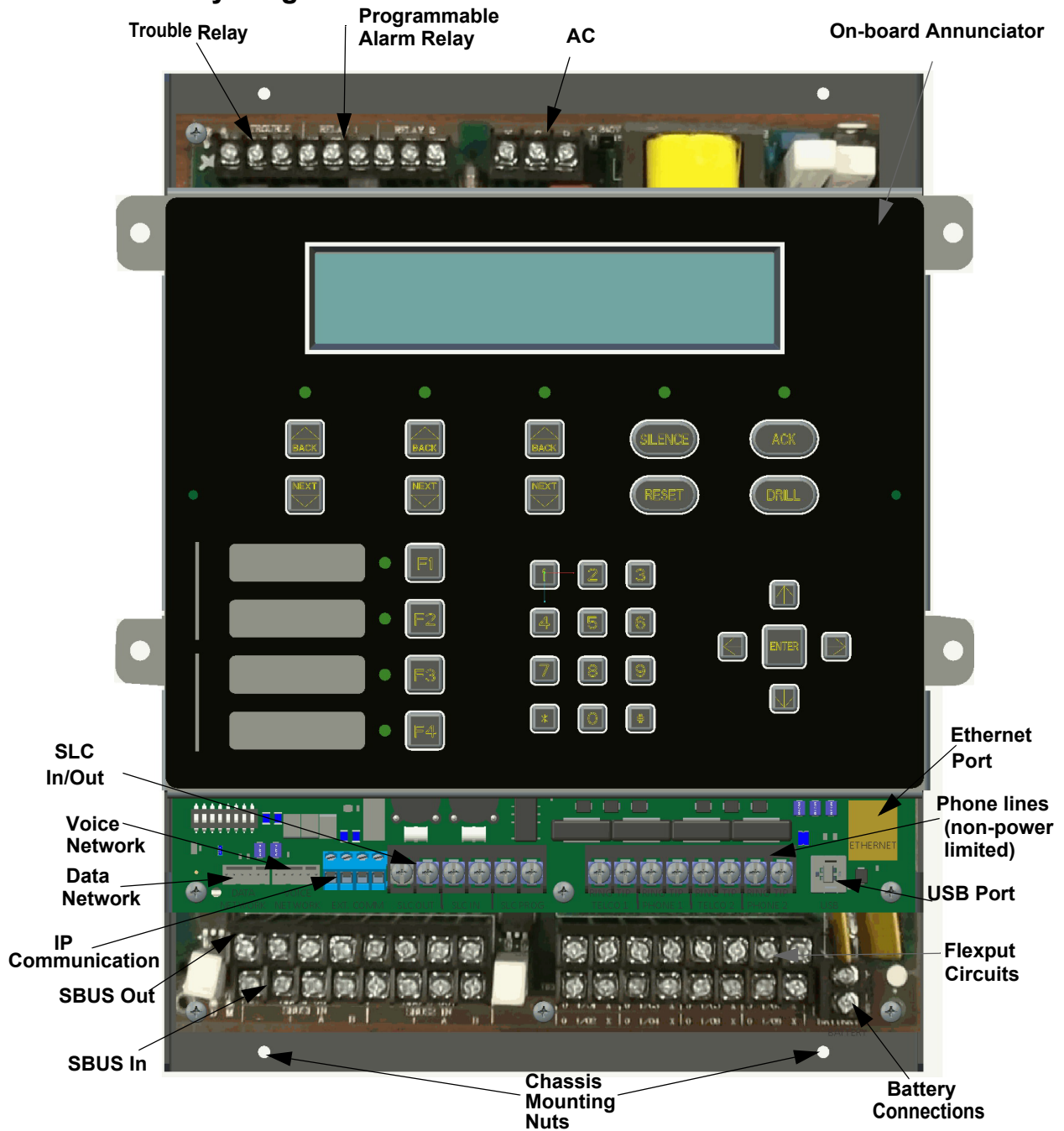

Figure 3.3 Model IFP-2100 Assembly

Figure 3.3 shows the circuit boards, metal housing and annunciator that attach the IFP-2100/ECS assembly to the cabinet. If you should need to remove the board assembly for repair, remove the four mounting nuts which hold the assembly in the cabinet. Then lift the entire assembly out of the cabinet. Do not attempt to remove the circuit boards from the metal bracket.

3.7 Calculating Current Draw and Standby Battery

This section is for helping you determine the current draw and standby battery needs for your installation.

3.7.1 Current Draw Worksheet Requirements

The following steps must be taken when determining IFP-2100/ECS current draw and standby battery requirements.

1. You will use the Current Draw Worksheet to determine current draw and standby battery requirements. Use Table 3.2 if installing IDP SLC Devices, Table 3.3 if installing SK SLC Devices or use Table 3.4 if installing SD SLC Devices For the IFP-2100/ECS, the worst case current draw is listed for the panel, addressable devices, and all SBUS expanders. Fill in the number of addressable devices and expanders that will be used in the system and compute the current draw requirements for alarm and standby. Record this information in the current draw worksheet on Line A.
2. Add up the current draw for all auxiliary devices and record in the table on Line B.
3. Add up the current draw for all notification appliance loads and record in the table on Line C.
4. For notification appliances and auxiliary devices not mentioned in the manual, refer to the device manual for the current ratings.
5. Make sure that the total alarm current you calculated, including current for the panel itself, does not exceed 9.0 A. This is the maximum alarm current for the IFP-2100/ECS control panel. If the current is above 9.0 A you will need to use a notification power expander(s) such as the 5496 or the RPS-1000 intelligent power expander, to distribute the power loads so that the IFP-2100/ECS or the power expanders do not exceed their power ratings. Refer to the current draw worksheets provided with the 5496 or the RPS-1000 manuals so you do not exceed their power ratings.
6. Alternatively, you may network additional IFP-2100/ECS or RFP-2100s to get additional power.
7. Complete the remaining instructions in the appropriate current draw worksheet for determining battery size requirements.

3.7.2 Current Draw Worksheet for IDP SLC Devices

Use Table 3.2 to determine current requirements during alarm/battery standby operation when IDP SLC devices are installed. You can install up to 159 IDP sensors per loop (2100 points max per panel) *and* 159 IDP modules per loop (2100 points max per panel). Copy this section if additional space is required.

Device	# of Devices	Current per Device		Standby Current	Alarm Current
For each device use this formula: This column X This column = Current per number of devices.					
Fire Panel (Battery current draw)	1	Standby:	230 mA	230 mA	
		Alarm:	415 mA		415 mA
Addressable SLC Devices					
IDP-PHOTO		Standby/Alarm:	.30 mA ¹	mA	mA
IDP-PHOTO-T				mA	mA
IDP-PHOTOR				mA	mA
IDP-HEAT				mA	mA
IDP-HEAT-HT				mA	mA
IDP-ACCLIMATE				mA	mA
IDP-HEAT-ROR		Standby/Alarm	.30 mA ¹	mA	mA
IDP-PHOTO-W / IV Detector		SLC	Standby:	200µA	mA
			Alarm:	4.5mA	
IDP-PHOTO-R-W / IV Detector		SLC	Standby:	200µA	mA
			Alarm:	4.5mA	
IDP-PHOTO-T-W / IV Detector		SLC	Standby:	200µA	mA
			Alarm:	4.5mA	
IDP-HEAT-W / IV Detector		SLC	Standby:	200µA	mA
			Alarm:	4.5mA	
IDP-HEAT-ROR-W / IV Detector		SLC	Standby:	200µA	mA
			Alarm:	4.5mA	
IDP-HEAT-HT-W / IV Detector		SLC	Standby:	200µA	mA
			Alarm:	4.5mA	
IDP-BEAM (without integral test)		SLC	Standby/Alarm:	2 mA	mA
		Aux. Pwr	Standby:	2 mA	mA
			Alarm:	8.5 mA	
IDP-BEAM-T ⁵ (with integral test)		SLC	Standby/Alarm:	2 mA	mA
		Aux. Pwr	Standby:	2 mA	mA
			Alarm:	8.5 mA	
DNR ⁶ (non-relay)		None, included with IDP-PHOTOR			
DNR ⁷ (with relay)		None, included with IDP-PHOTOR & IDP-RELAY			

Table 3.2 Current Draw Worksheet for IDP SLC Devices

Device	# of Devices	Current per Device		Standby Current	Alarm Current
IDP-FIRE-CO		SLC	Standby: .30 mA	mA	
			Alarm: 7.2 mA		mA
IDP-MONITOR		Standby/Alarm .375 mA		mA	mA
IDP-MINIMON				mA	mA
IDP-PULL-SA / IDP-PULL-DA				mA	mA
IDP-MONITOR-2		Standby/Alarm: .75 mA		mA	mA
IDP-MONITOR-10		Standby/Alarm: 3.5 mA		mA	mA
IDP-CONTROL		SLC	Standby .375 mA	mA	
			Alarm: .375 mA		mA
		Aux Pwr	Standby 1.7 mA	mA	
	Alarm: 7mA			mA	
IDP-CONTROL-6	SLC	Standby 2.25 mA	mA		
		Alarm: 2.25 mA		mA	
	Aux Pwr	Standby 8 mA	mA		
		Alarm: 20 mA		mA	
IDP-RELAY	Standby/Alarm: .255 mA		mA	mA	
IDP-RELAY-6	Standby/Alarm: 1.45 mA		mA	mA	
IDP-RELAYMON-2	Standby: 1.3 mA		mA		
	Alarm: 24 mA			mA	
IDP-ZONE	Aux Pwr	Standby 12 mA	mA		
		Alarm: 90 mA		mA	
	SLC	Standby/Alarm .27 mA	mA	mA	
IDP-ZONE-6	Aux Pwr	Standby 50 mA	mA		
		Alarm: 70 mA		mA	
	SLC	Standby/Alarm 2 mA	mA	mA	
SLC Accessories					
B200SR / IV / WH Sounder Base	Aux Pwr	Standby: .5mA	mA		
		Alarm: 35mA		mA	
B200S / IV / WH intelligent Sounder Base	SLC	Standby 3mA	mA		
	Aux Pwr	Standby: .5mA	mA		
		Alarm: (high vol) 35mA		mA	
B200SR-LF / IV / WH Low Frequency Sounder Base	Aux Pwr	Standby: 1mA	mA		
		Alarm: 125mA		mA	
B200S-LF/ IV / WH Low Frequency Sounder Base	Aux Pwr	Standby .55mA	mA		
		Alarm (high vol) 140mA		mA	
	SLC	Standby .30mA	mA		
B224RB / IV /WH Relay Base	Standby/Alarm: .5mA		mA	mA	
RT151/151 KEY	Alarm: 7.5 mA			mA	
RA100Z	Alarm: 10 mA			mA	
SLC Isolator Devices					
IDP-ISO (Isolator Module)	(318 max/loop & 2100 max/panel)	Standby/Alarm: 0.45 mA		mA	mA
ISO-6 (6 Fault Isolator Module)		Standby: (per circuit) .45 mA		mA	
		Alarm: (per circuit) 17 mA			mA
B224BI / IV / WH Isolator Base		Standby/Alarm: 0.5 mA		mA	mA

Color Guide: -WH = White, -IV = Ivory

Table 3.2 Current Draw Worksheet for IDP SLC Devices

Device	# of Devices	Current per Device	Standby Current	Alarm Current
Accessories Modules				
6815 SLC Loop Expander	(63 max) ⁴	Standby:	78 mA	mA
		Alarm:	78 mA	mA
RA-2000 Remote LCD Annunciator	(63 max) ⁴	Standby:	20 mA	mA
		Alarm:	25 mA	mA
RA-1000 Remote LCD Annunciator	(31 max)	Standby:	20 mA	mA
		Alarm:	25 mA	mA
RA-100 Remote LCD Annunciator		Standby:	25 mA	mA
		Alarm:	50 mA	mA
5824 Serial/Parallel Module	(4 max.)	Standby/Alarm:	45 mA	mA
5496 NAC Expander	(63 max) ⁴	Standby/Alarm:	10 mA	mA
RPS-1000 Power Supply		Standby/Alarm:	10 mA	mA
5865-4 LED Annunciator (with reset and silence switches)	(63 max) ⁴	Standby:	35 mA	mA
		Alarm:	145 mA	mA
5865-3 LED Annunciator Module	(63 max) ⁴	Standby:	35 mA	mA
		Alarm:	145 mA	mA
5880 LED I/O Module		Standby:	35 mA	mA
		Alarm:	200 mA	mA
5883 Relay Interface	(63 max) ⁴	Standby:	0 mA	mA
		Alarm: (22 mA/relay)	220 mA	mA
ESC-50W or ECS-125W Voice Amplifier with/without ECS-CE4	(16 max.)	Standby	10 mA	mA
		Alarm	10 mA	mA
ECS-INT50W Internal Amplifier	(16 max.)	Standby:	52 mA	mA
		Alarm @ 25V:	275 mA	mA
		Alarm @ 70V:	310 mA	mA
ECS-DUAL50W Dual Voice Amp	(16 max.)	Standby/Alarm:	10 mA	mA
ECS-50WBU Back-Up Amplifier	(16 max.)	Standby/Alarm:	10 mA	mA
ECS-VCM Voice Control Module	(1 max.)	Standby:	70 mA	mA
		Alarm:	100 mA	mA
ECS-NVCM Voice Control Module		Standby/Alarm:	59 mA	mA
ECS-SW24 Switch Expander	(32 max.)	Standby:	10 mA	mA
		Alarm:	25 mA	mA
ECS-RPU Remote Paging Unit	(15 max.)	Standby:	70 mA	mA
		Alarm:	100 mA	mA
ECS-LOC Local Operating Console (includes RA-2000, RVM & SW-24)		Standby:	105 mA	mA
		Alarm:	175 mA	mA
ECS-LOC2100 Local Operating Console (includes RA-2000, RVM and 2ea - SW-24)		Standby:	115 mA	mA
		Alarm:	180 mA	mA
Network Cards				
SK-NIC Network Interface Card	(1 Max.)	Standby/Alarm:	21 mA	mA
SK-FML Fiber Optic Multi Mode	(1 Max.)	Standby/Alarm:	53 mA	mA
SK-FSL Fiber Optic Single Mode	(1 Max.)	Standby/Alarm:	79 mA	mA
Wireless Modules				
WIDP-WGI Wireless Gateway		Max current using ext supply	40 mA	mA
		Max current SLC Power	24 mA	mA
Total System Current				
Auxiliary Devices²		Refer to devices manual for current rating		
IPDACT-2 IP Communicator	(1 max.)	Standby:	93 mA	mA
		Alarm:	136 mA	mA

Table 3.2 Current Draw Worksheet for IDP SLC Devices

Device	# of Devices	Current per Device		Standby Current	Alarm Current
IPDACT-2UD IP Communicator	(1 max.)	Standby:	98 mA	mA	
		Alarm:	155 mA		mA
CELL-MOD/CELL-CAB-SK		Standby:	55 mA	mA	
		Alarm:	100 mA		mA
		Alarm/Standby:	mA	mA	mA
		Alarm/Standby:	mA	mA	mA
		Alarm/Standby:	mA	mA	mA
Auxiliary Devices Current					
Notification Devices	Refer to device manual for current rating				
5495/5499 Power Supply		24 VDC	One input circuit:	15 mA	mA
			Both input circuits:	30 mA	mA
		Alarm:	mA		mA
		Alarm:	mA		mA
		Alarm:	mA		mA
Notification Appliances Current					
Total current ratings of all devices in system (line A + line B + C)				mA	mA
Total current ratings converted to amperes (line D x .001):				A	A
Number of standby hours				H	
Multiply lines E and F.			Total standby AH		AH
Alarm sounding period in hours. (For example, 5 minutes = .0833 hours)					H
Multiply lines E and H.			Total alarm AH		AH
Add lines G and I. ³				AH	
Multiply by the Derating Factor				x 1.25	
				Total ampere hours required	

Table 3.2 Current Draw Worksheet for IDP SLC Devices

1. The FACP can only support 5 devices w/LED's on. The current draw has been added to the panels alarm current.
2. If using door holders, you do not need to consider door holder current for alarm/battery standby, because power is removed during that time. However, during normal operation, door holders draw current and must be included in the 9.0A total current that can be drawn from the panel.
3. Use next size battery with capacity greater than required.
4. Maximum SBUS address capacity is 63 SBUS modules. The practical limit is determined by the amount of SBUS bandwidth consumed by each SBUS module. See section 4.13.2.
5. The IDP-BEAM-T draws a maximum of 500mA from auxiliary power when the test feature is used. This should be considered when determining auxiliary power capacity but not calculated into current requirements for day to day operation.
6. The IDP-PHOTOR is sold separately from the DNR. Current draw for the DNR + IDP-PHOTOR is calculated by increasing the "Number of Devices" column for each IDP-PHOTOR used with a DNR.
7. The DNR housing does not include a Relay circuit board. If a relay is needed, be sure to add one to the IDP-RELAY & IDP-PHOTOR "Number of Devices" column for each DNR used for correct current calculations.

3.7.3 Current Draw Worksheet for SK SLC Devices

Use Table 3.3 to determine current requirements during alarm/battery standby operation when SK SLC devices are installed. You can install up to 159 SK sensors per loop (2100 points max per panel) and 159 modules per loop (2100 points max per panel).

Device	# of Devices	Current per Device		Standby Current	Alarm Current
For each device use this formula: This column X This column = Current per number of devices.					
Fire Panel (Battery current draw)	1	Standby:	230 mA	230 mA	
		Alarm:	415 mA		415 mA

Table 3.3 Current Draw Worksheet for SK SLC Devices

Device	# of Devices	Current per Device		Standby Current	Alarm Current
Addressable SLC Detectors					
SK-PHOTO		Standby/Alarm: .30 mA ¹		mA	mA
SK-PHOTO-T				mA	mA
SK-HEAT				mA	mA
SK-HEAT-HT				mA	mA
SK-ACCLIMATE				mA	mA
SK-HEAT-ROR				mA	mA
SK-DUCT ⁵ (includes PhotoR)				mA	mA
SK-PHOTO-W Detector		SLC	Standby: 200µA	mA	
			Alarm: 4.5mA		mA
SK-PHOTO-R-W Detector		SLC	Standby: 200µA	mA	
			Alarm: 4.5mA		mA
SK-HEAT-W Detector		SLC	Standby: 200µA	mA	
			Alarm: 4.5mA		mA
SK-HEAT-ROR-W Detector		SLC	Standby: 200µA	mA	
			Alarm: 4.5mA		mA
SK-HEAT-HT-W Detector		SLC	Standby: 200µA	mA	
			Alarm: 4.5mA		mA
SK-BEAM (without integral test)		SLC	Standby/Alarm: 2 mA		
			Aux. Pwr	Standby: 2 mA	mA
				Alarm: 8.5 mA	
SK-BEAM-T ⁴ (with integral test)		SLC	Standby/Alarm: 2 mA	mA	mA
			Aux. Pwr	Standby: 2 mA	mA
				Alarm: 8.5 mA	
SK-FIRE-CO		SLC	Standby: .30mA	mA	
			Alarm: 7.2mA		mA
Addressable SLC Module					
SK-MONITOR		Standby/Alarm: .375 mA		mA	mA
SK-MINIMON				mA	mA
SK-PULL-SA				mA	mA
SK-PULL-DA				mA	mA
SK-MONITOR-2		Standby/Alarm: .75 mA		mA	mA
SK-MON-10		Standby/Alarm: 3.5 mA		mA	mA
SK-CONTROL		SLC	Standby: .375 mA	mA	
			Alarm: .375 mA		mA
		Aux Pwr	Standby: 1.7 mA	mA	
			Alarm: 7 mA		mA
SK-CONTROL-6	SLC	Standby: 2.25 mA	mA		
		Alarm: 2.25 mA			
	Aux Pwr	Standby: 8 mA	mA		
		Alarm: 20 mA		mA	
SK-RELAY	Standby/Alarm: .255 mA		mA	mA	
SK-RELAY-6	Standby/Alarm: 1.45 mA		mA	mA	
SK-RELAYMON-2	Standby: 1.3 mA		mA		
	Alarm: 24 mA			mA	

Table 3.3 Current Draw Worksheet for SK SLC Devices

Device	# of Devices	Current per Device		Standby Current	Alarm Current	
SK-ZONE		Aux Pwr	Standby	12 mA	mA	
			Alarm	90 mA		mA
SK-ZONE-6		SLC	Standby/ Alarm	.27 mA	mA	mA
			Aux Pwr	Standby	50 mA	mA
				Alarm	270mA	
		SLC	Standby/Alarm	2mA	mA	mA
SLC Modules						
B200SR / IV / WH Sounder Base		Aux Pwr	Standby:	.5mA	mA	
			Alarm:	35mA		mA
B200S / IV / WH intelligent Sounder Base		SLC	Standby	.3mA	mA	
			Aux Pwr	Standby:	.5mA	mA
				Alarm: (high vol)	35mA	
B200SR-LF / IV / WH Low Frequency Sounder Base		SLC	Standby	.3mA	mA	
			Aux Pwr	Standby:	1mA	mA
				Alarm:	125mA	
B200S-LF/ IV / WH Low Frequency Sounder Base		Aux Pwr	Standby	.55mA	mA	
						Alarm (high vol)
		SLC	Standby	.30mA	mA	
B224RB / IV /WH Relay Base			Standby/Alarm:	0.5mA	mA	mA
RTS151/151 KEY			Alarm:	7.5 mA		mA
RA100Z			Alarm:	10 mA		mA
SLC Isolator Devices						
SK-ISO (Isolator Module)	(318 max/loop & 2100 max/panel)		Standby/Alarm:	.45 mA	mA	mA
B224BI-WH / IV Isolator Base			Standby/Alarm:	.5 mA	mA	mA
Color Guide: -WH = White, -IV = Ivory						
Accessories Modules						
6815 SLC Loop Expander	(63 max.)		Standby/Alarm:	78 mA	mA	mA
RA-2000 Remote LCD Annunciator	(63 max.) ⁴		Standby:	20 mA	mA	
			Alarm:	25 mA		mA
RA-1000 Remote LCD Annunciator	(31 max.)		Standby:	20 mA	mA	
			Alarm:	25 mA		mA
RA-100 Remote LCD Annunciator			Standby:	25 mA	mA	
			Alarm:	50 mA		mA
5824 Serial/Parallel I/O Module	(4 max.)		Standby/Alarm:	45mA	mA	mA
RPS-1000 Power Supply	(63 max.)		Standby/Alarm:	10mA	mA	mA
5496 NAC Expander			Standby/Alarm:	10 mA	mA	mA
5865-4 LED Annunciator (with reset and silence switches)			Standby:	35 mA	mA	
			Alarm:	145 mA		mA
5865-3 LED Annunciator	63 (max.)		Standby:	35 mA	mA	
			Alarm:	145 mA		mA
5880 I/O Module			Standby:	35 mA	mA	
			Alarm:	200 mA		mA
5883 Relay Interface	(63 max.)		Standby:	0 mA	mA	
			Alarm:	220 mA (22 mA per relay)		mA

Table 3.3 Current Draw Worksheet for SK SLC Devices

Device	# of Devices	Current per Device		Standby Current	Alarm Current
ECS-50W or ECS-125W Audio Amplifier with/without EVS-CE4	(16 max.)	Standby:	10 mA	mA	
		Alarm:	10 mA		mA
ECS-INT50W Internal Amplifier	(16 max.)	Standby:	52 mA	mA	
		Alarm @ 25V:	275 mA		mA
		Alarm @ 70V:	310 mA		mA
ECS-VCM Voice Control Module	(1 max.)	Standby:	70 mA	mA	
Alarm:		100 mA		mA	
ECS-NVCM Voice Control Module		Standby/Alarm:	59 mA	mA	mA
ECS-SW24 Switch Expander	(32 max.)	Standby:	10 mA	mA	
		Alarm:	25 mA		mA
ECS-RPU Remote Paging Unit	(15 max.)	Standby:	70 mA	mA	
		Alarm:	100 mA		mA
ECS-LOC Local Operating Console (includes RA-2000, RVM & SW-24)	(15 max.)	Standby:	105 mA	mA	
		Alarm:	175 mA		mA
Total System Current					
Network Cards					
SK-NIC Network Interface Card	(1 Max.)	Standby/Alarm:	21 mA	mA	mA
SK-FML Fiber Optic Multi Mode	(1 Max.)	Standby/Alarm:	53 mA	mA	mA
SK-FSL Fiber Optic Single Mode	(1 Max.)	Standby/Alarm:	79 mA	mA	mA
Wireless Modules					
SK-WGI Wireless Gateway		Max current using ext supply	40 mA	mA	mA
		Max current SLC Power	24 mA	mA	mA
Total System Current					
Auxiliary Devices ²		Refer to devices manual for current rating.			
IPDACT-2 IP Communicator	(1 max.)	Standby:	93 mA	mA	
		Alarm:	136 mA		mA
IPDACT-2UD IP Communicator	(1 max.)	Standby:	98 mA	mA	
		Alarm:	155 mA		mA
CELL-MOD/CELL-CAB-SK		Standby:	55 mA	mA	
		Alarm:	100 mA		mA
		Alarm/Standby:	mA	mA	mA
		Alarm/Standby:	mA	mA	mA
		Alarm/Standby:	mA	mA	mA
		Alarm/Standby:	mA	mA	mA
Auxiliary Devices Current					
Notification Appliance Circuits		Refer to device manual for current rating.			
5495/5499 Power Supply		24 VDC	One input circuit:	15 mA	mA
			Both input circuits:	30 mA	mA
		Alarm:	mA		mA
		Alarm:	mA		mA
		Alarm:	mA		mA
		Alarm:	mA		mA
Notification Appliances Current					mA
Total current ratings of all devices in system (line A + line B + C)				mA	mA
Total current ratings converted to amperes (line D x .001):				A	A
Number of standby hours:				H	
Multiply lines E and F.			Total standby AH		AH
Alarm sounding period in hours. (For example, 5 minutes = .0833 hours)					H
Multiply lines E and H.			Total alarm AH		AH

Table 3.3 Current Draw Worksheet for SK SLC Devices

Device	# of Devices	Current per Device	Standby Current	Alarm Current
Add lines G and I. ³			AH	
Multiply by the Derating Factor			x 1.25	
Total ampere hours required				

Table 3.3 Current Draw Worksheet for SK SLC Devices

1. The FACP can only support 5 devices w/LED's on. This current draw has been added to the panels alarm current.
2. If using door holders, you do not need to consider door holder current for alarm/battery standby, because power is removed during that time. However, during normal operation, door holders draw current and must be included in the 6.0A total current that can be drawn from the panel.
3. Use next size battery with capacity greater than required.
4. SK-BEAM-T draws a maximum of 500mA from Auxiliary power only when the test feature is used. this should be considered when determining auxiliary power capacity but not calculated into current requirements for day to day operation.
5. The SK-DUCT housing contains a vacant mount for a SK-RELAY (sold separately). Current draw for the SK-RELAY is calculated by increasing the SK-RELAY row of the calculation sheet by one for each SK-RELAY used with a SK-DUCT.

3.7.4 Current Draw Worksheet for SD SLC Devices

Use Table 3.4 to determine current requirements during alarm/battery standby operation when SD SLC devices are installed. You can install up to 127 SD devices per loop (2032 max per panel). Copy this section if additional space is required.

Device	# of Devices	Current per Device		Standby Current	Alarm Current
For each device use this formula:		This column	X This column	=	Current per number of devices.
Fire Panel (Battery current draw)	1	Standby:	230 mA	230 mA	
		Alarm:	415 mA		415 mA
SD500-AIM		Standby/Alarm: .55 mA ⁶		mA	mA
SD500-MIM				mA	mA
SD500-PS				mA	mA
SD500-ARM				mA	mA
SD505-HEAT				mA	mA
SD505-PHOTO				mA	mA
SD500-ANM		Aux. Pwr	Standby: 8 mA	mA	
			Alarm: 60 mA		mA
SD500-SDM		SLC	Standby/Alarm: .55 mA	mA	mA
		Aux. Pwr	Standby: 20 mA	mA	
			Alarm: 106 mA		mA
SLC Accessory Base					
SD505-6RB		Standby/Alarm: .082 mA		mA	mA
SD505-6SB		Aux. Pwr	Standby: 1 mA	mA	
			Alarm: 32 mA		mA
SD505-6SD		SLC	Standby/Alarm: .082 mA	mA	mA
		Aux. Pwr	Standby: 20 mA ²	mA	
			Alarm: 62 mA ²		mA
SD505-DUCTR		SLC	Standby/Alarm: .5mA	mA	mA
		Aux. Pwr	Standby: 20 mA ²	mA	
SD505-DTS-K		None, included with SD505-DUCTR worst case.			
SD505-DUCT		SLC	Standby/Alarm .5mA	mA	mA

Table 3.4 Current Draw Worksheet for SD SLC Devices

Device	# of Devices	Current per Device	Standby Current	Alarm Current
SLC Isolator Devices				
SD505-LIM	(1272 max.)	Standby/Alarm	.092mA	mA
SD505-6IB	(2032 max.)			
Accessories Modules				
5815XL SLC Expander	(63 max.) ⁵	Standby/Alarm:	55mA	mA
RA-2000 Remote LCD Annunciator	(63 max.) ⁴	Standby:	20mA	mA
		Alarm:	25mA	mA
RA-1000 Remote LCD Annunciator		Standby:	20mA	mA
		Alarm:	25mA	mA
RA-100 Remote LCD Annunciator		Standby:	25mA	mA
		Alarm:	50mA	mA
5824 Serial/Parallel Printer Interface Module	(4 max.)	Standby/Alarm:	45mA	mA
5496 NAC Expander	(63 max.) ⁵	Standby/Alarm:	10mA	mA
RPS-1000 Power Supply		Standby/Alarm:	10mA	mA
5865-4 LED Annunciator (with reset and silence switches)	(63 max.) ⁵	Standby:	35mA	mA
		Alarm:	145mA	mA
5865-3 LED Annunciator	(63 max.) ⁵	Standby:	35mA	mA
		Alarm:	145mA	mA
5880 LED I/O Module		Standby:	35mA	mA
		Alarm:	200mA	mA
5883 Relay Interface	(63 max.) ⁵	Standby:	0mA	mA
		Alarm:	220mA (22 mA per relay)	mA
ECS-VCM Voice Control Module	(1 max.)	Standby:	70mA	mA
ECS-NVCM Network Voice Control Module		Standby/Alarm:	59mA	mA
ECS-SW24 Switch Expander	(32 max.)	Standby:	10mA	mA
		Alarm:	25mA	mA
ECS-50W or ECS-125W Audio Amplifier with/without ECS-CE4	(16 max.)	Standby:	10mA	mA
		Alarm:	10mA	mA
ECS-INT50W Internal Amplifier	(16 max.)	Standby:	52mA	mA
		Alarm @ 25V:	275mA	mA
		Alarm @ 70V:	310mA	mA
ECS-RPU Remote Paging Unit	(15 max.)	Standby:	70mA	mA
		Alarm:	100mA	mA
ECS-LOC Local Operating Console (includes RA-2000, RVM & SW-24)		Standby:	105mA	mA
		Alarm:	175mA	mA
ECS-DUAL50W Dual Voice Amp	(16 max.)	Standby/Alarm:	10mA	mA
ECS-50WBU Back-Up Amplifier	(16 max.)	Standby/Alarm:	10mA	mA
Network Cards				
SK-NIC Network Interface Card	(1 Max.)	Standby/Alarm:	21 mA	mA
SK-FML Fiber Optic Multi Mode	(1 Max.)	Standby/Alarm:	53 mA	mA
SK-FSL Fiber Optic Single Mode	(1 Max.)	Standby/Alarm:	79 mA	mA
A Total System Current				
Auxiliary Devices ³	Refer to devices manual for current rating.			
IPDACT-2 IP Communicator		Alarm:	136 mA	mA
		Standby:	93 mA	mA

Table 3.4 Current Draw Worksheet for SD SLC Devices

Device	# of Devices	Current per Device		Standby Current	Alarm Current
IPDACT-2UD IP Communicator		Alarm:	155 mA		mA
		Standby:	98 mA	mA	
CELL-MOD/CELL-CAB-SK		Standby:	55 mA	mA	
		Alarm:	100 mA		mA
		Alarm/Standby:	mA	mA	mA
		Alarm/Standby:	mA	mA	mA
		Alarm/Standby:	mA	mA	mA
B Auxiliary Devices Current					
Notification Devices	Refer to devices manual for current rating.				
5495/5499 Power Supply		24 VDC	One input circuit:	15 mA	mA
			Both input circuits:	30 mA	mA
		Alarm:	mA		mA
		Alarm:	mA		mA
		Alarm:	mA		mA
		Alarm:	mA		mA
C Notification Appliances Current					
D Total current ratings of all devices in system (line A + line B + C)				mA	mA
E Total current ratings converted to amperes (line D x .001):				A	A
F Number of standby hours				H	
G Multiply lines E and F.			Total standby	AH	AH
H Alarm sounding period in hours. (For example, 5 minutes = .0833 hours)					
I Multiply lines E and H.			Total alarm	AH	AH
J Add lines G and I. ⁴					
Multiply by the Derating Factor				x 1.25	
			Total ampere hours required		

Table 3.4 Current Draw Worksheet for SD SLC Devices

1. Total does not include isolator devices or accessory bases.
2. If using 24 VDC aux power only. No standby or alarm current for battery calculation if using 24VAC, 120VAC or 240VAC.
3. If using door holders, you do not need to consider door holder current for alarm/battery standby, because power is removed during that time. However, during normal operation, door holders draw current and must be included in the 9.0A total current that can be drawn from the panel.
4. Use next size battery with capacity greater than required.
5. Maximum SBUS address capacity is 63 SBUS modules. The practical limit is determined by the amount of SBUS bandwidth consumed by each SBUS module. See section 4.13.2.
6. The FACP can only support 2 devices w/LED's on. The current draw has been added to the panels alarm current.

3.7.5 Maximum Battery Standby Load

“: Maximum Battery Standby Loads for 24 Hour Standby” on page 34 and “: Maximum Battery Standby Loads for 90 Hour Standby*” on page 35 show the standby load calculations for the IFP-2100 based on 24 and 90 hours of standby. The standby load calculations of line D in the Current Draw Calculation Worksheet must be less than the number shown in “: Maximum Battery Standby Loads for 24 Hour Standby” on page 34 and “: Maximum Battery Standby Loads for 90 Hour Standby*” on page 35 for the selected battery size, standby hour and alarm time. The numbers below have a built in 20% derating factor for the battery amp-hour capacity.

Rechargeable Battery Size	24 hr Standby, 5 mins. Alarm	24 hr Standby, 15 min alarm	24 hr Standby, 20 min alarm
17AH	535 mA	473 mA	442 mA
18AH	569 mA	506 mA	475 mA
24AH	769 mA	706 mA	675 mA

Table 3.5 : Maximum Battery Standby Loads for 24 Hour Standby

Rechargeable Battery Size	24 hr Standby, 5 mins. Alarm	24 hr Standby, 15 min alarm	24 hr Standby, 20 min alarm
33AH	1.07A	1.01A	975 mA
35AH	1.14A	1.07A	1.04A
40AH	1.30A	1.24A	1.21A
55AH	1.80A	1.74A	1.71A

Table 3.5 : Maximum Battery Standby Loads for 24 Hour Standby

Rechargeable Battery Size	90 hr Standby, 5 min alarm	90 hr Standby, 15 min alarm	90 hr Standby, 20 min alarm
33 AH	N/A	N/A	N/A
40 AH	347 mA	331 mA	322 mA
55 AH	480 mA	464 mA	456 mA

Table 3.6 : Maximum Battery Standby Loads for 90 Hour Standby*



WARNING: Honeywell Farenhyt does not support the use of batteries smaller than those listed in Table 3.5 and Table 3.6. If you use a battery too small for the installation, the system could overload the battery resulting in the installation having less than the required 24 hours standby power. Use Table 3.5 and Table 3.6 to calculate the correct battery amp hour rating needed for your installation. It is recommended that you replace batteries every five years.

*For FM Installation only

Section 4: Control Panel Installation

4.1 Mounting the Control Panel Cabinet

Read the environmental specifications in Section 3.2 before mounting the control panel cabinet. This will ensure that you select a suitable location.

The IFP-2100 cabinet can be surface or flush mounted. Cabinet base dimensions are 24¾" H x 14.5" W. If you flush mount there should be 1.5" to 1.75" of cabinet extruding from the wall, this should be measured from either the top edge or bottom edge to the exterior side of the sheet rock. Do NOT flush mount in a wall designated as a fire break.

The IFP-2100/ECS cabinet can be surface or flush mounted. Cabinet base dimensions are 26½" H x 20"W. If you flush mount the cabinet, there should be 1.5" to 1.75" of cabinet extruding from the wall, this should be measured from either the top edge or bottom edge to the exterior side of the sheet rock. Do NOT flush mount in a wall designated as a fire break.

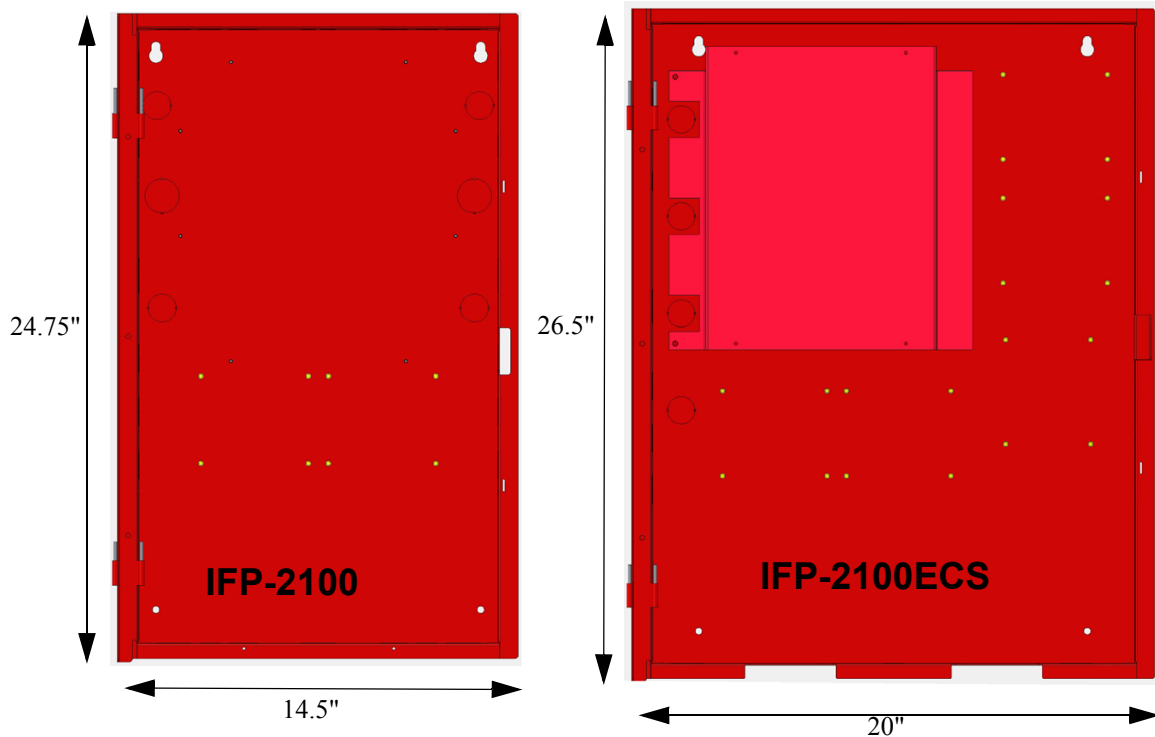

Figure 4.1 FACP Cabinet Mounting

4.1.1 Preventing Water Damage

Water damage to the fire system can be caused by moisture entering the cabinet through the conduits. Conduits that are installed to enter the top of the cabinet are most likely to cause water problems. Installers should take reasonable precautions to prevent water from entering the cabinet. Water damage is not covered under warranty.

4.1.2 Removing the IFP-2100/ECS Assembly from the Housing

Should it ever be necessary to remove the control panel assembly from the cabinet for repair, do so by unscrewing the nuts that connect the control panel assembly to the cabinet. Do not attempt to disassemble the circuit boards.

4.1.3 Ethernet Connection

Ethernet connect for IP communication. For port location see Figure 3.3.



WARNING: RISK OF ELECTRICAL SHOCK AND EQUIPMENT DAMAGE

Several different sources of power can be connected to this panel. Disconnect all sources of power before servicing. The panel and associated equipment may be damaged by removing and/or inserting cards, modules or interconnecting cables while this unit is energized.

4.2 AC Power Connection



WARNING: RISK OF ELECTRICAL SHOCK AND EQUIPMENT DAMAGE

Several different sources of power can be connected to this panel. Disconnect all sources of power before servicing. The panel and associated equipment may be damaged by removing and/or inserting cards, modules or interconnecting cables while this unit is energized

The AC terminals are rated at 120VAC, 50 or 60 Hz, 5A (for the IFP-2100/ECS) or 240VAC, 50 or 60 Hz, 2.8A (for the IFP-2100/ECSHV.)

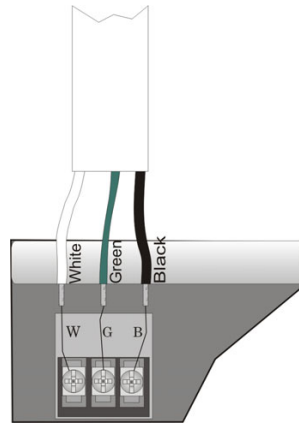

Figure 4.2 120 VAC Power Connection for the IFP-2100/ECS

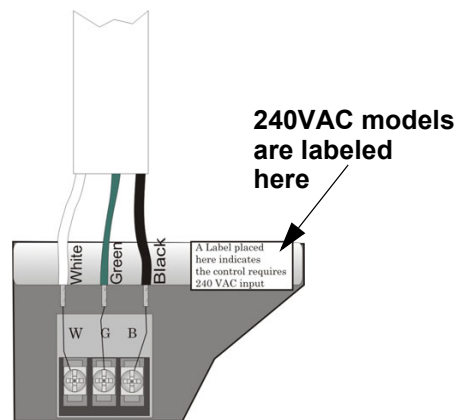

Figure 4.3 240VAC Power Connection for the IFP-2100/ECSHV

4.3 Battery Power

The batteries must be sealed lead acid type. Before connecting the batteries to the FACP, make certain that the interconnect cable between the batteries is not connected. Do not connect the battery jumper cable until the system is completely installed. Observe polarity when connecting the batteries.



WARNING: RISK OF PERSONAL INJURY

Battery contains sulfuric acid which can cause severe burns to the skin and eyes and can destroy fabrics. If contact is made with sulfuric acid, immediately flush the skin or eyes with water for 15 minutes and seek immediate medical attention

The control panel battery charge capacity is 17 to 55 AH. Use 12V batteries of the same AH rating. Determine the correct AH rating as per your standby load calculation (see Section 3.7).

Wire batteries in series to produce a 24-volt equivalent. Do not parallel batteries to increase the AH rating. It is recommended that you replace batteries every five years.

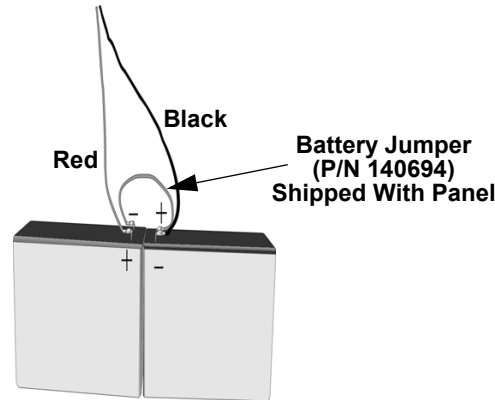

Figure 4.4 Battery Connection

4.3.1 Battery Accessory Cabinets

The Model RBB or AB-55 Accessory cabinets can be used when you are required to use backup batteries that are too large to fit into the main control panel cabinet.

The RBB cabinet holds batteries up to the 35 AH size. The RBB dimensions are 16" W x 10" H x 6" D (40.64 cm W x 25.4 cm H x 15.24 cm D).

The AB-55 Accessory cabinet holds batteries up to the 55AH size. The AB-55 dimensions are 20" W x 11.5" H x 7.5" D (50.8 cm W x 30.48 cm H x 19.05 cm D).

Installing the RBB or AB-55 Accessory Cabinet and Batteries

To properly install the accessory cabinet and backup batteries, follow these steps:

1. Mount the accessory cabinet. See Figure 4.5 for the four cabinet mounting holes.
 - If mounting onto drywall the accessory cabinet must be mounted onto $\frac{3}{4}$ -inch plywood. This is necessary because the weight of the batteries inside the accessory cabinet could cause the cabinet to pull away from the drywall.
 - When mounting on concrete, especially when moisture is expected, attach a piece of $\frac{3}{4}$ -inch plywood to the concrete surface and then attach the RBB or AB-55 cabinet to the plywood.
 - If using the battery cable extenders provided (P/N 140643), mount the RBB or AB-55 cabinet no more than 18" away from the main control panel cabinet. This will ensure that the battery cables reach the battery terminals.

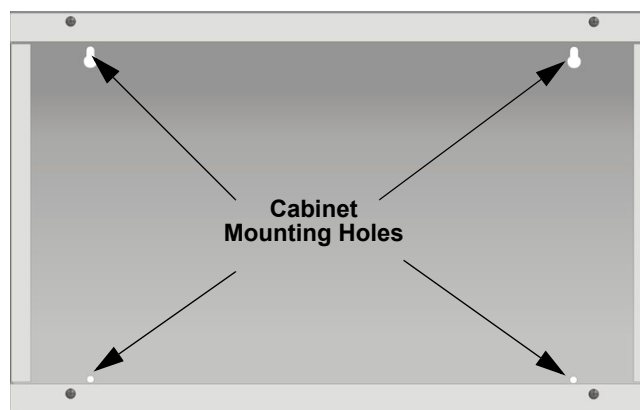

Figure 4.5 RBB or AB-55 Cabinet Mounting Holes

2. Connect the main control panel battery cables to the battery cable extenders as shown in Figure 4.6.

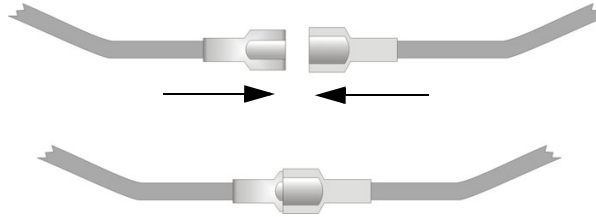

Figure 4.6 Splicing Control panel Battery Cable to RBB or AB-55 Battery Cable Extenders

3. Run extended battery cable from control panel cabinet through conduit to RBB or AB-55 cabinet. See Figure 4.7.

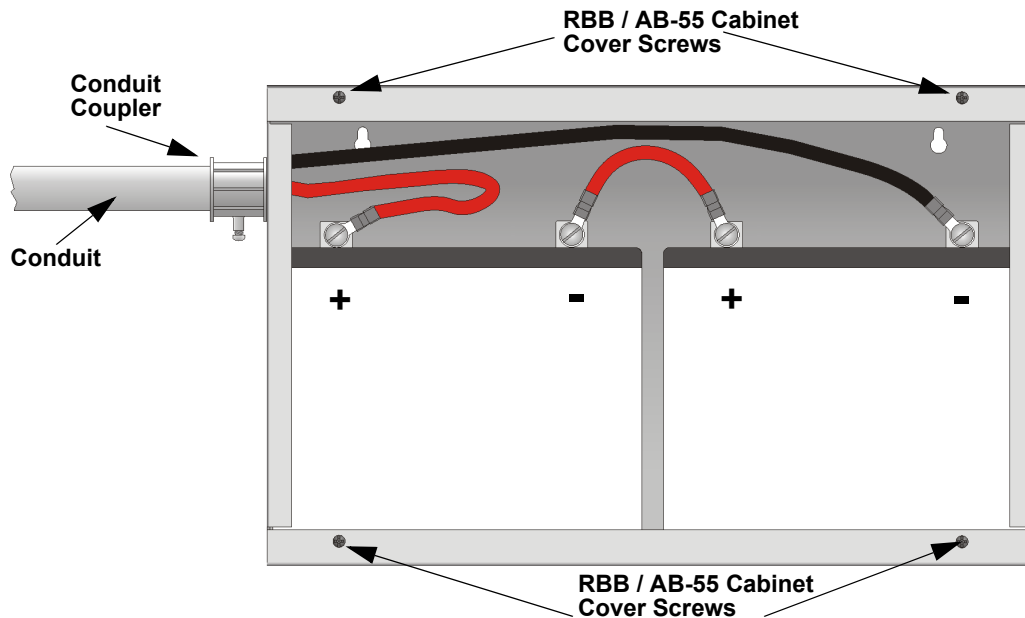

Figure 4.7 Battery Connections in the RBB or AB-55 Cabinet



NOTE: Figure 4.7 is an example of how the wire connections can be routed. However, any other cabinet knock-outs (on either the main control panel or the RBB/AB-55 cabinet), that are not previously being used may be utilized to connect conduit between the two cabinets.

4. Connect battery leads to the backup battery terminals. See Figure 4.7.
 - Observe the proper polarity to prevent damage to the batteries or the control panel.
5. Insert the RBB or AB-55 cover screws into the cover mounting holes. See Figure 4.7.
 - Screw the cover screw $\frac{3}{4}$ of the way into the cover mounting hole.
6. Align the cover plate mounting keyhole over the cover mounting screws. See Figure 4.8.

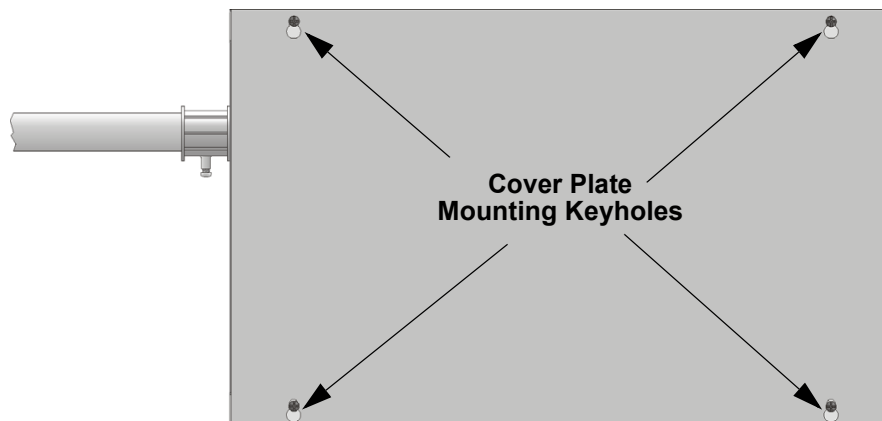

Figure 4.8 Cover Plate Mounting Keyholes and Cover Mounting Screws Alignment

7. Slide the cover into place and tighten the cover mounting screws. See Figure 4.8.

4.4 SBUS Wiring

This section contains information on calculating SBUS wire distances and the types of wiring configurations (Class A and B).

4.4.1 Calculating Wiring Distance for SBUS Modules

The IFP-2100/ECS panel has two SBUS circuits which can support up to 1.0A of module load per SBUS circuit. When determining the type of wire and the maximum wiring distance that can be used, you will need to calculate loads for each SBUS to ensure that each SBUS does not exceed 1.0A.

To calculate the wire gauge that must be used to connect SBUS modules to the control panel, it is necessary to calculate the total worst case current draw for all modules on a single SBUS circuit. The total worst case current draw is calculated by adding the individual worst case currents for each module. The individual worst case values are shown in the table below.



NOTE: Total worst case current draw on a single SBUS cannot exceed 1 amp. If a large number of accessory modules are required, and the worst case current draw will exceed the 2 amps total, then the current draw must be distributed using RPS-1000 Power Expanders. Each RPS-1000 Power Expander provides an additional SBUS, with an additional 1 amp of SBUS current. Wiring distance calculations are done separately for each RPS-1000, and separately for each control panel SBUS.

Model Number	Worst Case Current Draw
RA-2000, RA-1000, RA-100 Fire Annunciator	.120 amps
6815 SLC Loop Expander	.078 amps
5815XL SLC Loop Expander	.150 amps
5824 Serial/Parallel Printer Interface Module	.040 amps
5880 LED I/O Module	.250 amps
5865 LED Annunciator	.200 amps
RPS-1000 Intelligent Power Supply	.010 amps
5496 NAC Expander	.010 amps
ECS-50W	.010 amps
ECS-125W	.010 amps
ECS-VCM / ECS-VCM with ECS-SW24*	.115 amps / .185 amps
ECS-NVCM Network Voice Control Module	.059 amps
ECS-EMG NVCM keypad	.06 amps
ECS-LOC	.210 amps / .325 amps
ECS-DUAL50W	.010 amps
ECS-DUAL50W WITH ECS-50WBU	.010 amps
SK-NIC Network Interface Card	.021 amps
CELL-MOD/CELL-CAB-SK	.145 amps
SK-F485C Fiber Converter	.125 amps

Table 4.1 SBUS Device Current Draw



NOTE: Refer to Table 3.2 if using IDP SLC devices, Table 3.3 for SK devices, and refer to Table 3.4 if using SD SLC devices for maximum number of each type of device that can be used per system

* All devices must use the same SBUS and VBUS.

After calculating the total worst case current draw, refer to “Wire Distances Per Wire Gauge Using Copper Wire” on page 40 for the maximum distance the modules can be located from the panel on a single wire run. The table ensures 6.0 volts of line drop maximum. In general, the wire length is limited by resistance, but for heavier wire gauges, capacitance is the limiting factor.

These cases are marked in the chart with an asterisk (*). Maximum length can never be more than 6,000 feet, regardless of gauge used. The formula used to generate this chart is shown in the note below. The following formulas were used to generate the wire distance chart:

Wiring Distance: SBUS Modules to Panel				
Total Worst Case Current Draw (amps)	22 Gauge	18 Gauge	16 Gauge	14 Gauge
0.100	1852 ft.	4688 ft.	* 6000 ft.	* 6000 ft.
0.200	926 ft.	2344 ft.	3731 ft.	5906 ft.
0.300	617 ft.	1563 ft.	2488 ft.	3937 ft.
0.400	463 ft.	1172 ft.	1866 ft.	2953 ft.
0.500	370 ft.	938 ft.	1493 ft.	2362 ft.
0.600	309 ft.	781 ft.	1244 ft.	1969 ft.

Table 4.2 Wire Distances Per Wire Gauge Using Copper Wire

Wiring Distance: SBUS Modules to Panel				
Total Worst Case Current Draw (amps)	22 Gauge	18 Gauge	16 Gauge	14 Gauge
0.700	265 ft.	670 ft.	1066 ft.	1687 ft.
0.800	231 ft.	586 ft.	933 ft.	1476 ft.
0.900	206 ft.	521 ft.	829 ft.	1312 ft.
1.000 (Max)	185 ft.	469 ft.	746 ft.	1181 ft.

Table 4.2 Wire Distances Per Wire Gauge Using Copper Wire

$$\text{Maximum Resistance (Ohms)} = \frac{6.0 \text{ Volts}}{\text{Total Worst Case Current Draw (amps)}}$$

$$\text{Maximum Wire Length (Feet)} = \frac{\text{Maximum Resistance (Ohms)}}{\text{Rpu}} * 500$$

(6000 feet maximum)

where: Rpu = Ohms per 1000 feet for various wire gauges (see table below)

Wire Gauge	Ohms per 1000 feet (Rpu)
22	16.2
18	6.4
16	4.02
14	2.54

Table 4.3 Typical Wire Resistance Per 1000 ft. Using Copper Wire

■ **Wiring Distance calculation example:**

Suppose a system is configured with the following SBUS modules:

- 2 - Module RA-2000 Fire Annunciator
- 1 - RPS-1000 Intelligent Power Expander
- 1 - 5865 LED Annunciator
- 1 - 5824 Serial/Parallel Interface Module

The total worst case current is calculated as follows:

RA-2000 Current Draw	= 2 x .120 amps	= .240 amps
RPS-1000 Current Draw	= 1 x .010 amps	= .010 amps
5865 Current Draw	= 1 x .200 amps	= .200 amps
5824 Current Draw	= 1 x .040 amps	= .040 amps
Total Worst Case Current Draw		= .490 amps

Table 4-1



NOTE: For assistance with SBUS calculation, please refer to www.farenhyt.com.

Using this value, and referring to the Wiring Distance table, it can be found that the available options are:

- 370 feet maximum using 22 Gauge wire
- 938 feet maximum using 18 Gauge wire
- 1493 feet maximum using 16 Gauge wire
- 2362 feet maximum using 14 Gauge wire

4.4.2 Wiring Configurations

Figure 4.9 illustrates SBUS 1, Class A wiring configuration and Figure 4.10 illustrates SBUS1 Class B configuration SBUS 2 wiring configurations are the same as SBUS 1.

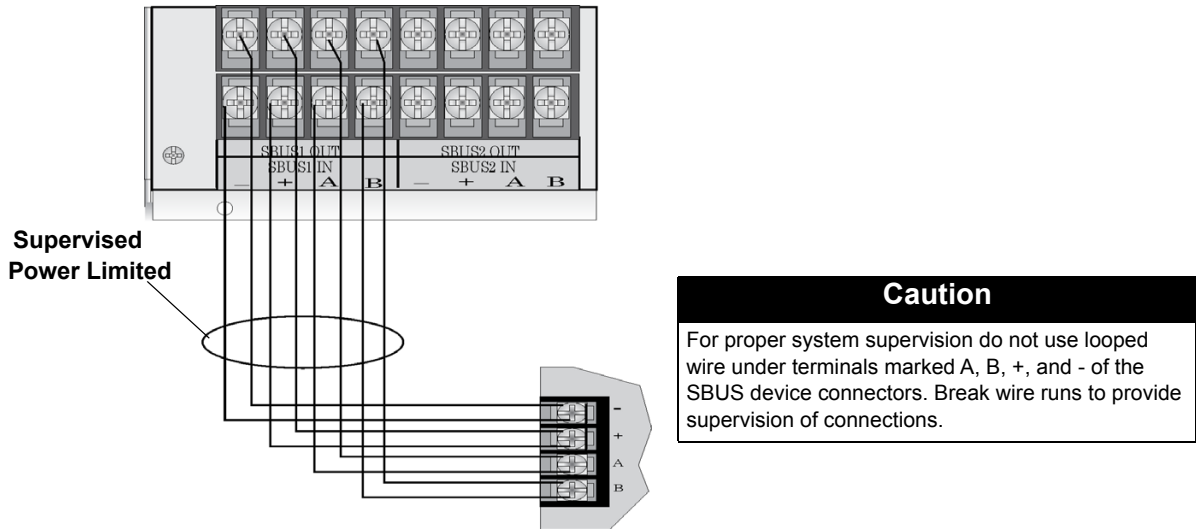

Figure 4.9 SBUS Class A Wiring

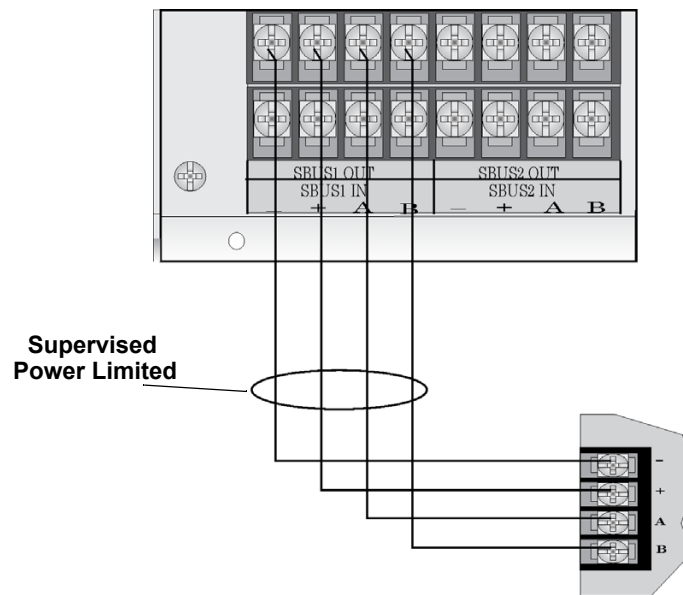

Figure 4.10 SBUS Class B Wiring

4.5 RA-2000 Remote Annunciator Installation

The optional Model RA-2000 Remote Annunciator, shown in Figure 4.11. The RA-2000 can be surface or flush mounted. It is available in gray color as RA-2000GRAY.



Figure 4.11 Model RA-2000 Remote Annunciator, Front View

RA-2000 installation involves the following steps:

1. Make sure power is off at the panel.
2. Mount the RA-2000 in the desired location (see Section 4.5.1).
3. Connect the RA-2000 to the panel (see Section 4.5.2).
4. Use the DIP switches on the back of the RA-2000 to assign an SBUS ID# to the RA-2000 (see Section 4.13.1).
5. The RA-2000 module must be added to the system through programming. JumpStart will add the module automatically (see Section 8.1). You can also add it manually (see Section 9.2.2). Select a name, if desired (see Section Naming Modules).

4.5.1 Mounting the RA-2000

Flush Mounting

Follow these steps to flush mount the RA-2000

1. The backbox dimensions are 9 1/4" W x 8 3/8" H. The backbox can be mounted prior to the complete installation of the RA-2000 using any of the mounting holes shown in Figure 4.12.

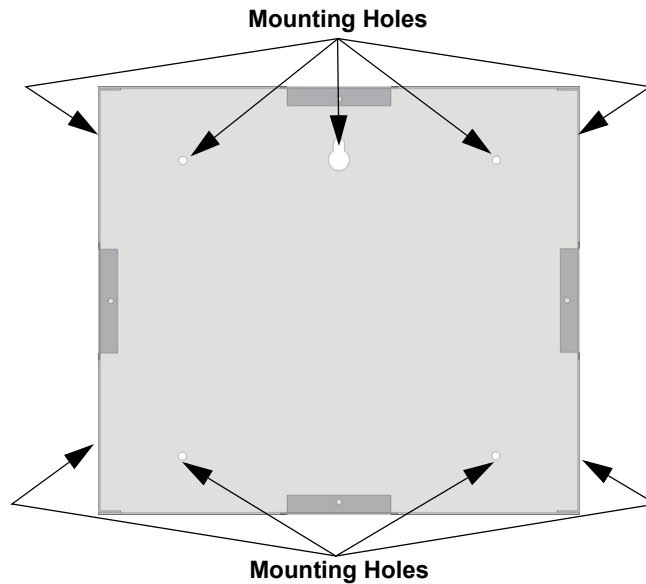

Figure 4.12 Backbox Mounting Holes

2. Remove knockout holes as needed for wires. See Figure 4.13 for backbox knockout locations.

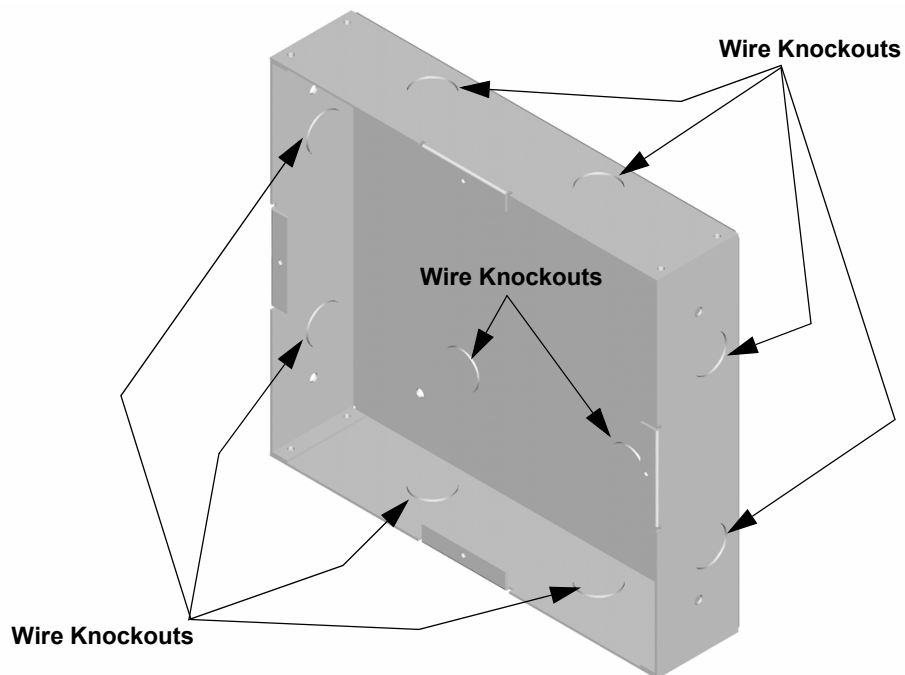

Figure 4.13 Backbox Knockout Locations

3. Wire the annunciator board to the main control panel. As described in Section 4.5.2.

- Attach the annunciator and door assembly to backbox as shown in Figure 4.14 using the supplied screws.

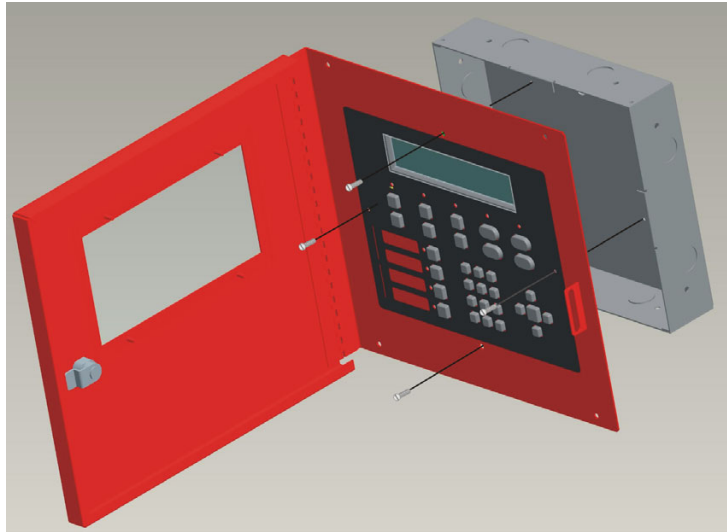

Figure 4.14 Attaching Annunciator / Door Assembly to Backbox

Surface Mounting

The Model RA-100TR red trim ring and RA-2000GRAYTR gray trim ring kits are available for use when surface mounting the RA-2000.

- Remove the desired knock out. See Figure 4.13.
- To properly mount the backbox, insert a single screw into the key shaped mounting hole. Do not tighten all the way. See Figure 4.15. Place a level on top of the backbox, with the backbox level insert the rest of the mounting screws.

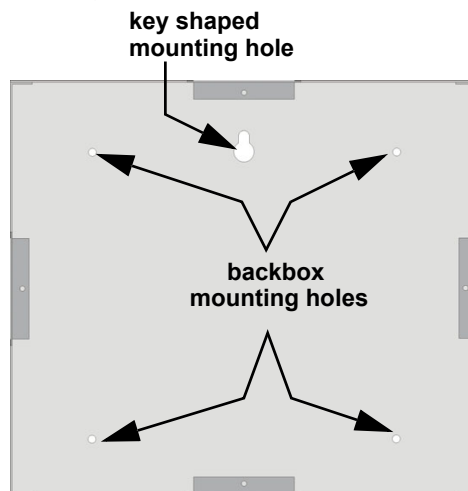

Figure 4.15 Backbox Surface Mount Holes

- Run wires to the control panel.

- Place the trim ring over the backbox as shown in Figure 4.16.

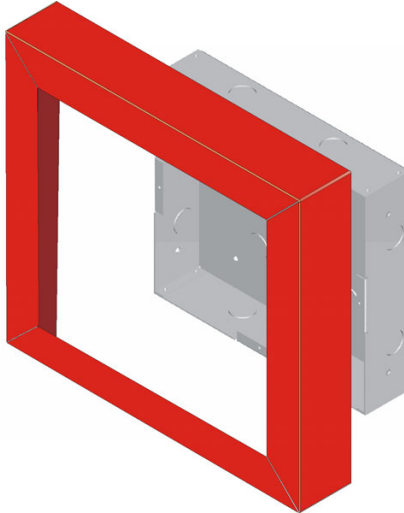

Figure 4.16 Installing Trim Ring

- Connect wires from the RA-2000 to the SBUS connectors on the FACP.
- Attach the annunciator and door assembly to the backbox using screws provided (see Figure 4.14).

4.5.2 RA-2000 Connection to the Panel

Connect the RA-2000 to the panel as shown in Figure 4.17.

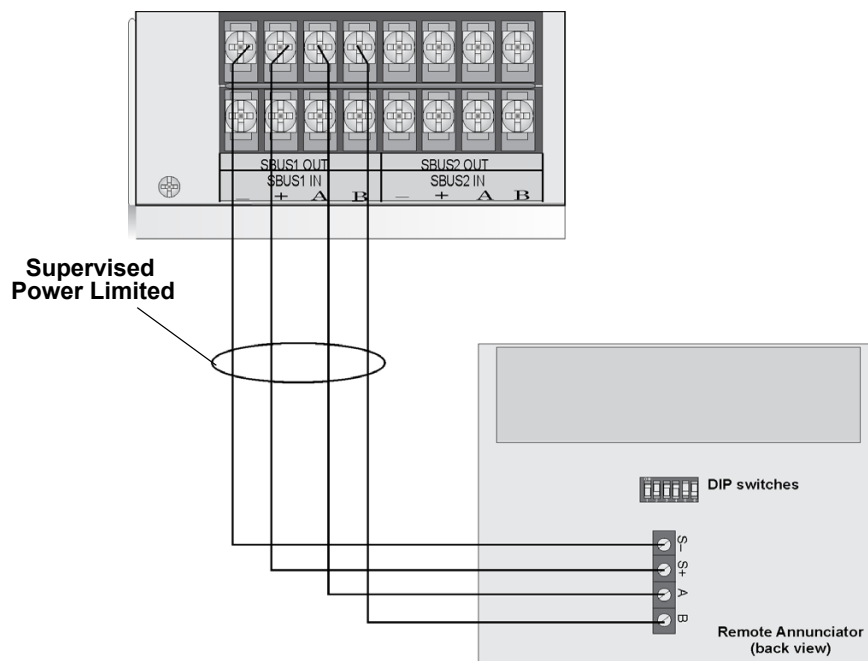

Figure 4.17 Model RA-2000 Connection to the Panel

4.5.3 Temporary Programming Display

When an RFP-2100 is being initially setup, place an RA-2000 on the panel at address 63 or address 31 for an RA-1000 or RA-100 and power up the panel. This will initiate the Temporary Programming Display feature. This allows the RA-2000, RA-1000 or RA-100 to act as the main annunciator for the RFP-2100 panel and allows access to the idle screen and menu system for programming. While in this mode, a trouble will be annunciated through the system to indicate the feature is being utilized. This is only available when no other annunciators are programmed into the system. When running JumpStart Auto-programming, the system will ask if the intention is to keep the display or remove it after programming.

When using the Temporary Display is no longer necessary; power the panel off, remove the display, and re-power the panel.

4.6 RA-1000 Remote Annunciator Installation

The optional Model RA-1000 Remote Annunciator, is shown in Figure 4.18. Up to 31 annunciators can be added to the IFP-2100 system.



Figure 4.18 Model RA-1000 Remote Annunciator, Front View

RA-1000 installation involves the following steps:

1. Make sure power is off at the panel.
2. Mount the RA-1000 in the desired location (see Section 4.6.1).
3. Connect the RA-1000 to the panel (see Section 4.6.2).
4. Use the DIP switches on the back of the RA-1000 to assign an ID# to the RA-1000 (see Section 4.12.1).
5. The new RA-1000 module must be added to the system through programming. JumpStart will add the module automatically (see Section 8.1). You can also add it manually (see Section 9.2.2). Select a name, if desired (see Section Naming Modules).

4.6.1 Mounting the RA-1000

This section of the manual describes mounting the remote annunciator. The annunciator can be flush- or surface-mounted.

Figure 4.19 shows the parts of the annunciator. Instructions for disassembling and mounting appear on the following pages.

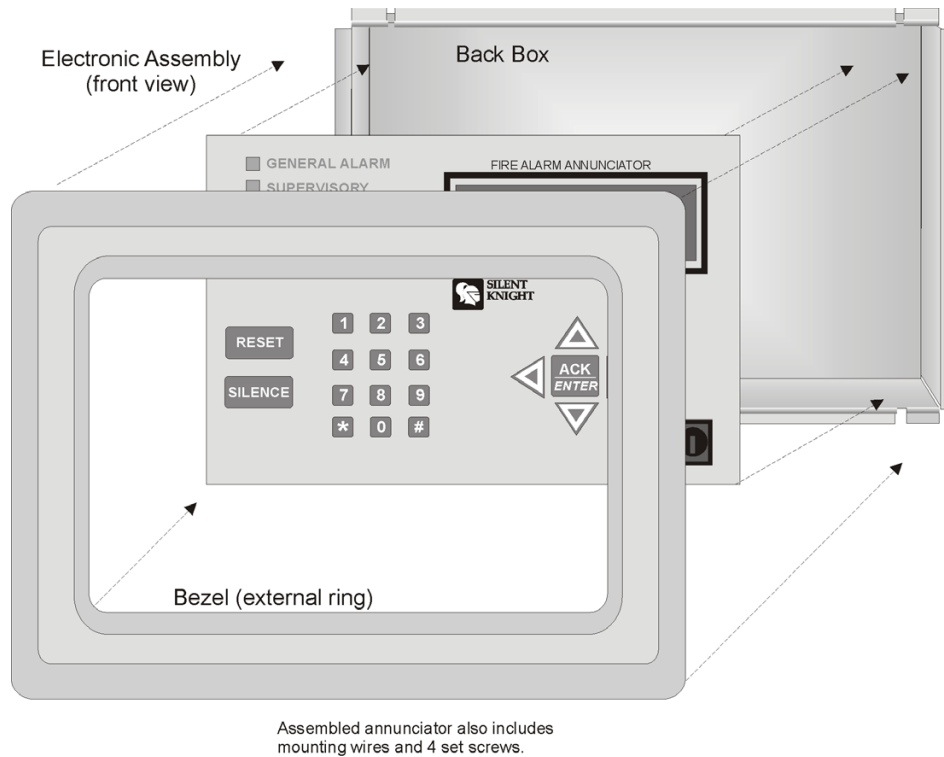

Figure 4.19 Annunciator Parts

The RA-1000 comes from the factory fully assembled. You must disassemble it for mounting. To disassemble the annunciator, use a 5/64 hex wrench to remove the set screws, located on the bottom of the annunciator bezel. (See Figure 4.20 for location of the set screws.)

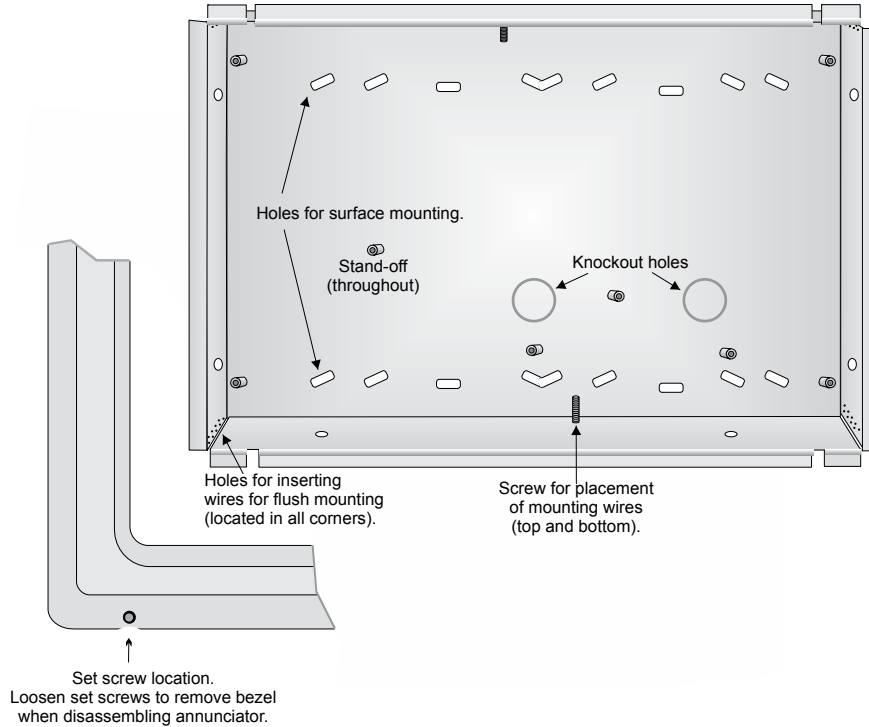

Figure 4.20 Annunciator Backbox and Bezel Details

Flush Mounting

This section of the manual describes flush mounting. You can flush-mount with or without an electrical box.

■ Flush Mounting with an Electrical Box

The RA-1000 annunciator can be used with the following types of electrical boxes: 4S, single-gang, and double-gang. If an electrical box is used, the box must be 1-3/8" back from the face of the wall to accommodate the annunciator. Studs used with an electrical box must be two by fours (or larger).

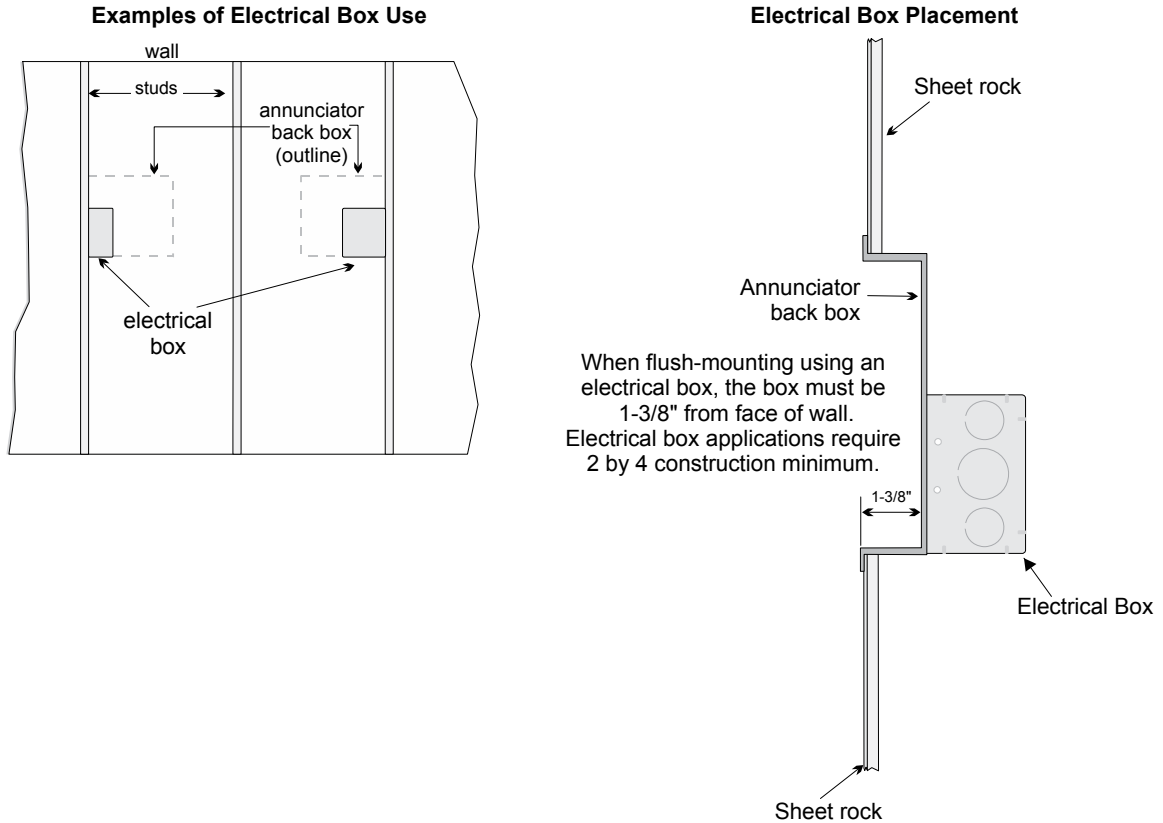

Figure 4.21 Placement of Electrical Box for Flush Mounting

■ Flush Mounting Steps

1. Cut a hole in the sheet rock to the following dimensions: 8-1/4" w x 6-5/8" h. If an electrical box is used, the box must be 1-3/8" back from face of wall to accommodate the annunciator (see Figure 4.21).
2. Remove knockout holes as needed for wires.
3. Fit the annunciator backbox into the hole and stabilize with mounting wires. Angle the mounting wires into the first hole past the sheet rock. Secure the wires behind the screws as shown in Figure 4.22. When all four wires are in place, the backbox should fit snugly into the hole in the sheet rock.
4. After the annunciator wiring to the panel has been completed (described in Section 4.6.2), replace the electronic assembly in the backbox. Place the bezel over the backbox and tighten the set screws on the bezel.

Attach second set of wires to top of back box.

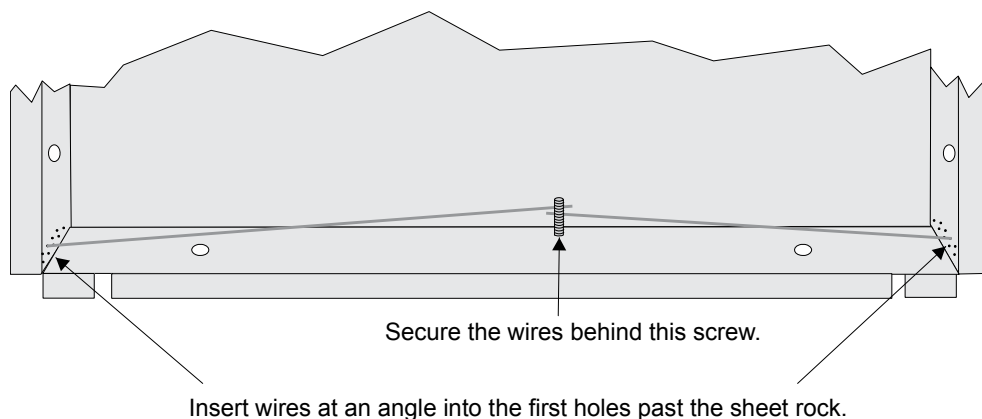

Figure 4.22 Flush Mounting the Backbox

Surface Mounting

The RA-1000 can be mounted directly to a surface or can be attached to a single, double, or four-square electrical box. The Model 5860TG/TR trim ring kit is available for use when surface mounting.

1. Drill holes in the surface to match the screw holes on the backbox.
2. Fit the trim ring over the backbox.
3. Attach the backbox to the surface using screws provided.
4. After the annunciator wiring to the panel has been completed (described in Section 4.6.2), replace the electronic assembly in the backbox. Place the bezel over the backbox and tighten the set screws on the bezel.

4.6.2 Model RA-1000 Connection to the Panel

Connect the RA-1000 to the panel as shown in Figure 4.23.

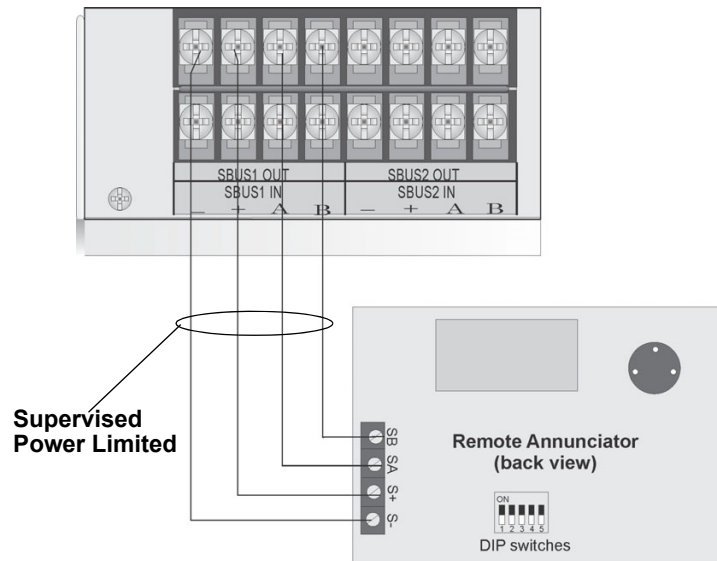

Figure 4.23 Model RA-1000 Connection to the Panel

4.7 RA-100 Remote Annunciator Installation

The optional Model RA-100 Remote Annunciator, is shown in Figure 4.24. The RA-100 can be surface or flush mounted. Up to 31 annunciators can be added to the IFP-2100 system in any combination.



Figure 4.24 Model RA-100 Remote Annunciator, Front View

RA-100 installation involves the following steps:

1. Ensure power is turned off at the panel.
2. Mount the RA-100 in the desired location (see Section 4.5.1).
3. Connect the RA-100 to the panel (see Section 4.7.2).
4. Use the DIP switches on the back of the RA-100 to assign an ID number to the RA-100 (see Section 4.13.1).
5. The RA-100 module must be added to the system through programming. JumpStart will add the module automatically (see Section 8.1). You can also add it manually (see Section 9.2.2). Select a name, if desired (see Section Naming Modules).

4.7.1 Mounting the RA-100

This section of the manual describes mounting the remote annunciator. The annunciator can be flush- or surface-mounted.

Flush Mounting

This section of the manual describes flush mounting.

Follow these steps to flush mount the RA-100:

1. The backbox dimensions are 9-9/32" W x 8-3/8" H. The backbox can be mounted prior to the complete installation of the RA-100 using any of the mounting holes shown in Figures 4.25.

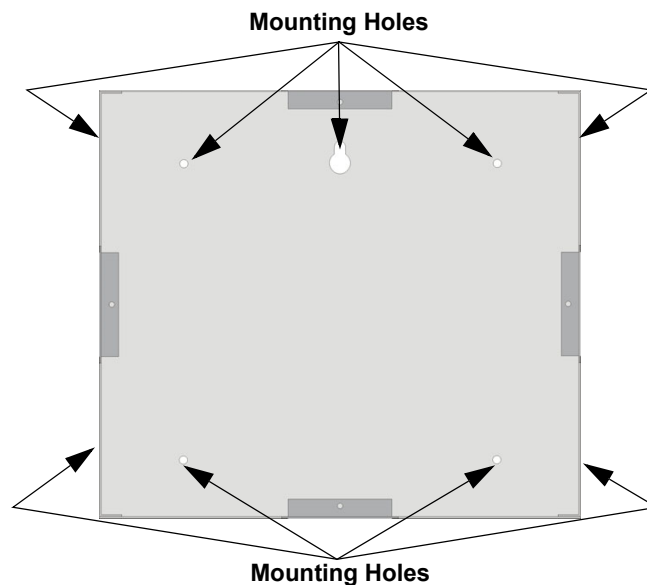

Figure 4.25 Backbox Mounting Holes

2. Remove knockout holes as needed for wires. See Figure 4.26 for backbox knockout locations

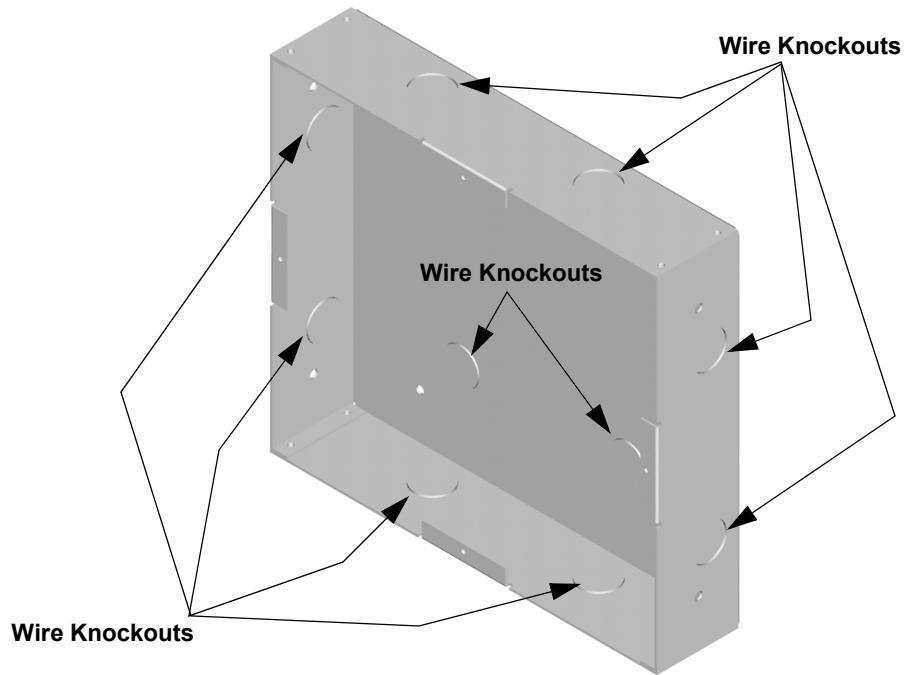

Figure 4.26 Backbox Knockout Locations

3. Wire the Annunciator board to the main control panel. See Figure 4.23.
4. Attach the annunciator/ door assembly to backbox as shown in Figure 4.14 using the supplied screws.

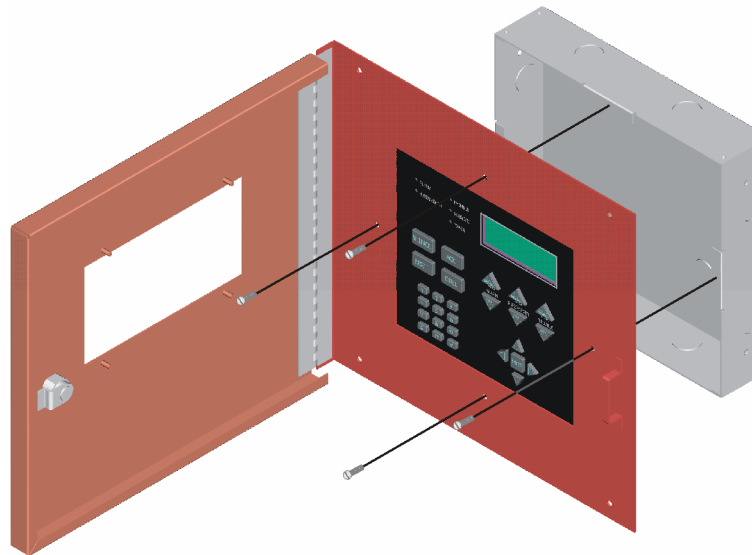

Figure 4.27 Attaching Annunciator/Door Assembly to Backbox

Surface Mounting

The Model RA-100TR trim ring kit is available for use when surface mounting.

1. Remove the desired knock out. See Figure 4.26.
2. To properly mount the backbox, insert a single screw into the key shaped mounting hole. Do not tighten all the way. See Figure 4.28.

Place a level on top of the backbox, with the backbox level insert the rest of the mounting screws.

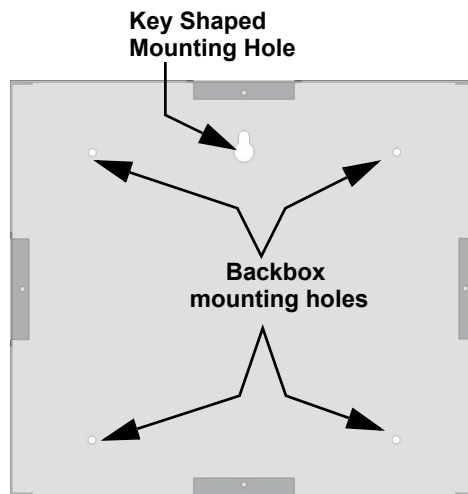

Figure 4.28 Backbox Surface Mount Holes

3. Run wires to the control panel.
4. Place the trim ring over the backbox as shown in Figure 4.29.

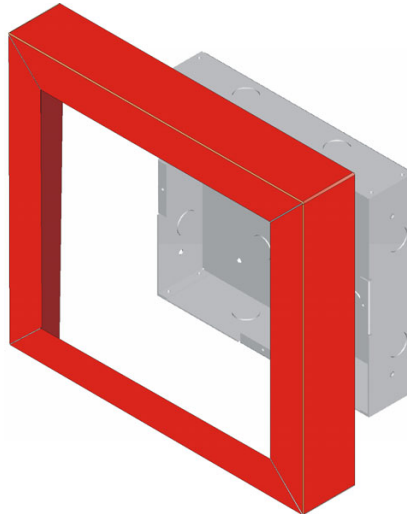

Figure 4.29 Installing Trim Ring

5. Connect wires from the RA-100 to the SBUS connectors on the FACP. (See Figure 4.30).
6. Attach the annunciator and door assembly to the backbox using screws provided.

4.7.2 Model RA-100 Connection to the Panel

Connect the RA-100 to the panel as shown in Figure 4.30.

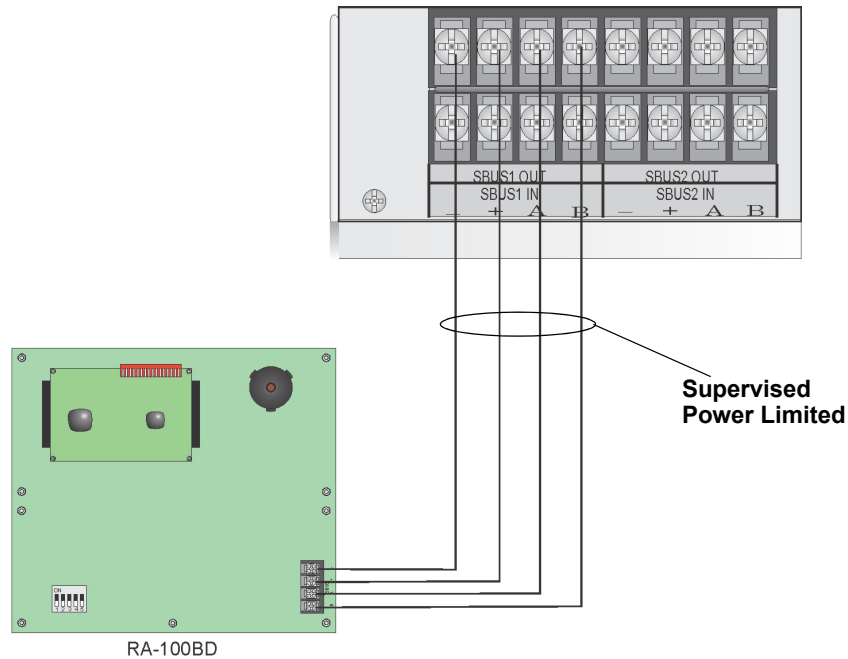

Figure 4.30 Model RA-100 Connection to the Panel

4.8 5815XL Installation

The 5815XL SLC expander lets you add additional addressable devices. The maximum number of SD SLC devices per panel is 2032. The number of 5815XL's is limited by the maximum number of SBUS devices.



NOTE: 5815XL will only support SD protocol devices on this panel

To install the 5815XL:

1. Make sure power is off at the panel.
2. Mount the 5815XL in the IFP-2100/ECS cabinet, the RPS-1000 cabinet, or the 5815RMK remote mounting kit. Use the standoffs located under the control panel board assembly and secure with screws provided with the 5815XL. For additional information see Model RPS-1000 Installation Instructions (P/N 151153) or 5815RMK Remote Mounting Kit Installation Instructions (P/N 151391).
3. Connect the 5815XL to the control panel. (See Section 4.8.1.)
4. Use on-board DIP switches to select an SBUS ID#. (See Section 4.13.1.)
5. Add the 5815XL module to the system through programming. JumpStart will add the module automatically (see Section 8.1). You can also add it manually (see Section 9.2.2). Select a name, if desired (see Section Naming Modules).

You are now ready to connect SLC devices to the 5815XL (see Section 7.6).

Figure 4.31 is a drawing of the 5815XL board, showing the location of terminals and DIP switches.

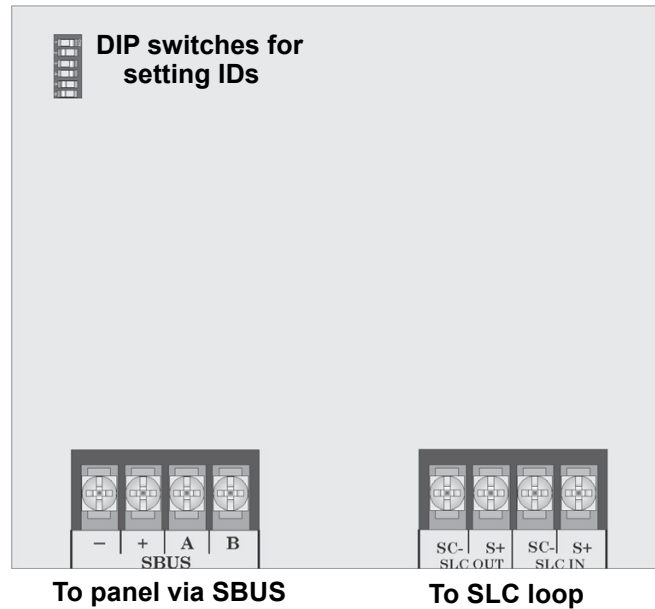

Figure 4.31 5815XL Board

4.8.1 5815XL Connection to the Panel

Connect the 5815XL to the control panel as shown in Figure 4.32. After the 5815XL is connected to the panel, it must be added to the system. This programming steps are described in Section 9.2.2.

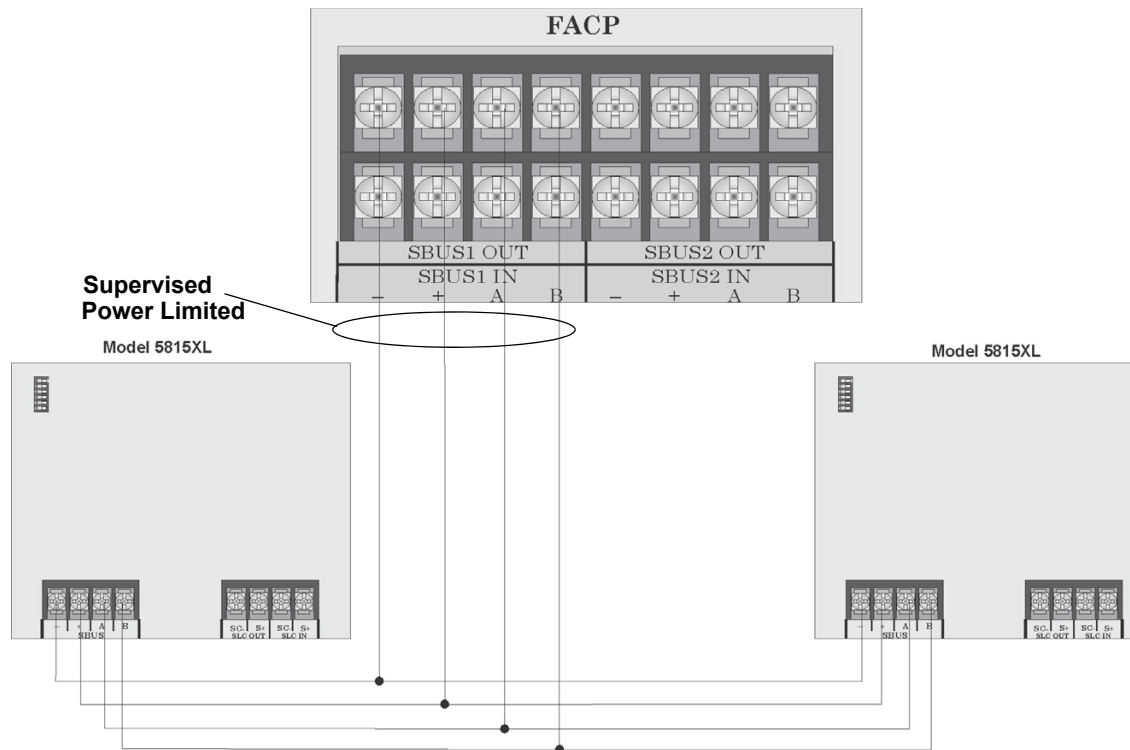

Figure 4.32 5815XL Connection to Main Panel Assembly

4.9 6815 Installation

The 6815 SLC expander lets you add additional addressable devices. The maximum number of IDP or SK SLC devices per panel is 2100. The number of 6815's is limited by the maximum number of SBUS devices.



NOTE: An external 6815 will support IDP, SK or SWIFT SLC devices.

To install the 6815:

1. Make sure power is off at the panel.
2. Mount the 6815 in the IFP-2100/ECS cabinet, the RPS-1000 cabinet, or the 5815RMK remote mounting kit. Use the standoffs located under the control panel board assembly and secure with screws provided with the 6815. For additional information see Model RPS-1000 Installation Instructions (P/N 151153) or 5815RMK installation sheet (P/N 151391).
3. Connect the 6815 to the control panel. (See Section 4.9.1.)
4. Use on-board DIP switches to select an SBUS ID#. (See Section 4.13.1.)
5. Add the 6815 module to the system through programming. JumpStart will add the module automatically (see Section 8.1). You can also add it manually (see Section 9.2.2). Select a name, if desired (see Section Naming Modules).

You are now ready to connect SLC devices to the 6815 (see Section 7.7).

Figure 4.33 is a drawing of the 6815 board, showing the location of terminals and DIP switches.

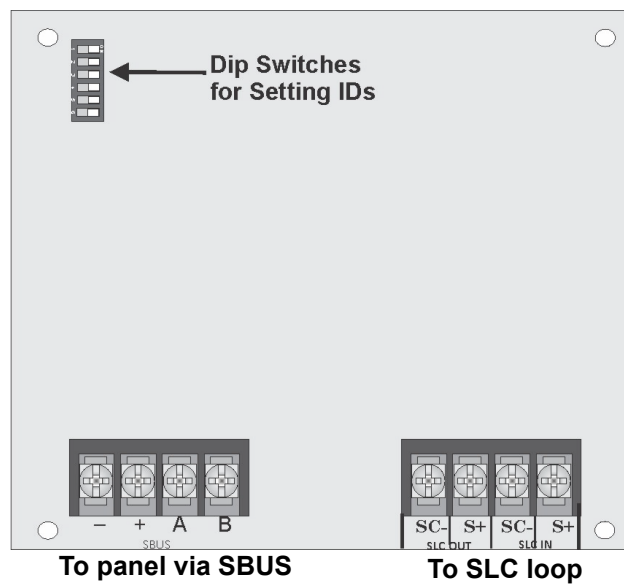

Figure 4.33 6815 Board

4.9.1 6815 Connection to the Panel

Connect the 6815 to the control panel as shown in Figure 4.34. After the 6815 is connected to the panel, it must be added to the system. This programming steps are described in Section 9.2.2.

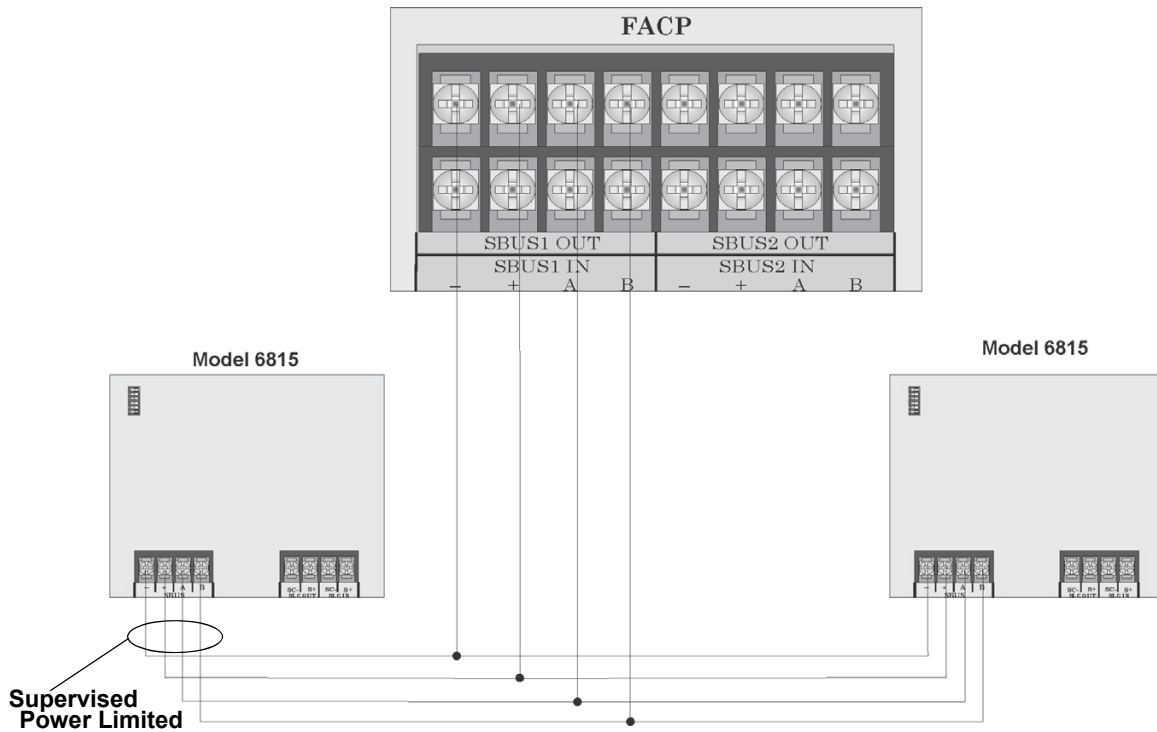

Figure 4.34 6815 Connection to Main Panel Assembly

4.10 5824 Serial/Parallel Interface Module Installation

The 5824 serial/parallel interface module allows you to connect a printer to the panel, so you can print a real-time log of system events. Instructions for installing the 5824 appear below. The 5824 is for ancillary use only.

5824 installation involves the following steps:

1. Ensure that all power has been removed from the FACP.
2. Connect the 5824 to the FACP as shown in Figure 4.35.



NOTE: Four 5824s per panel maximum

3. Use the DIP switches on the 5824 board to assign an SBUS ID# to the 5824 (see Section 4.13.1).

- Configure the 5824 device through programming. See Section 4.10.1.

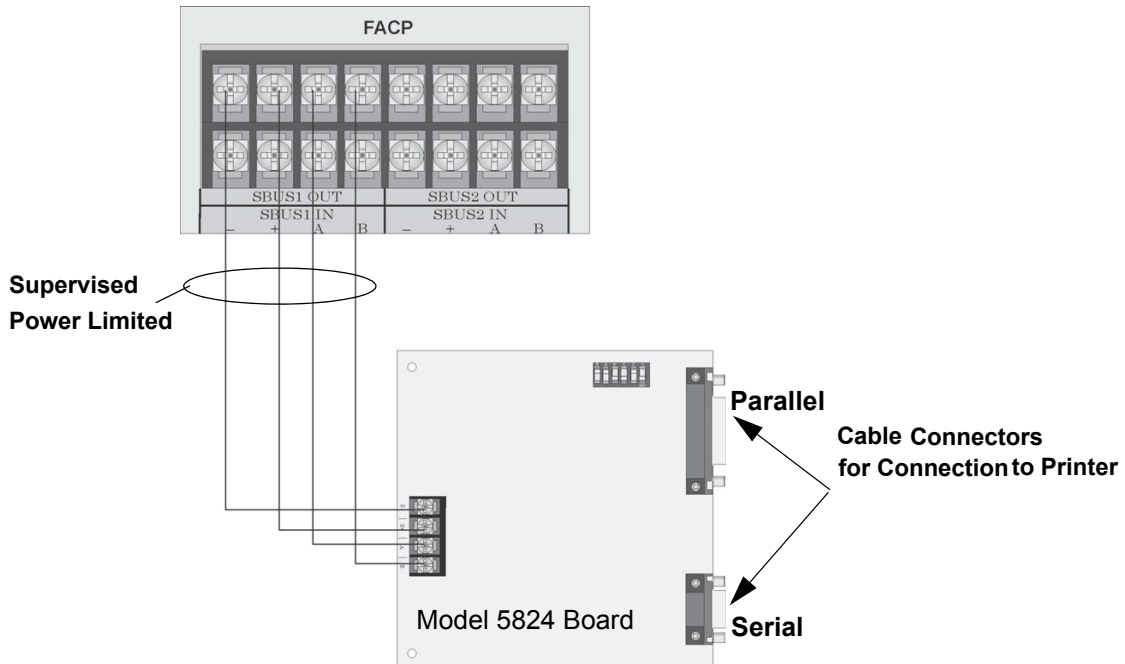

Figure 4.35 5824 Connection to the Panel

4.10.1 Selecting 5824 Options

Configuring the 5824 includes the following steps:

- Add the module to the system. JumpStart will add the module automatically (see Section 8.1). You can also add it manually (see Section 9.2.2).
- Select a name, if desired (see Section Naming Modules).
- Select options for the printer and the output port.

■ Printer and Output Port Options

- From the Main Menu, select 7 for Panel Programming.
- Select 1 for Module.
- Select 1 for Edit Module.
- From the list that displays, select the 5824 module you want to configure.
- Press right arrow twice to skip over the Enter Module ID and Enter Module Name options. A screen similar to the one shown in Figure 4.36 will display.

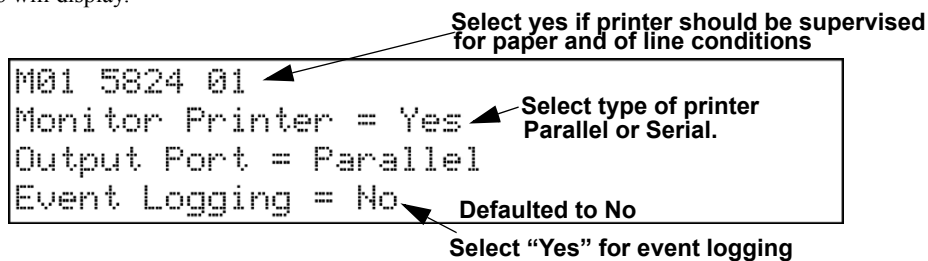

Figure 4.36 Selecting Printer and Output Port Options

- Select options for the printer as needed for your installation. Most printers are parallel.



NOTE: When setting Monitor Printer to “Yes” the system defaults to printing only for the connected panels site. Use HFSS Honeywell Fire Software Suite to configure the 5824 to print for multiple sites.

- If you are using a serial printer, use the next screen to select serial port options as required for your printer. Refer to your printer manual if you need more information.

Option	Choices
Baud Rate:	75 - 19200
Data Bits:	5 - 8
Stop Bits:	.5, 1, 2
Parity:	None, Even, Odd

4.11 5880 LED I/O Module

The 5880 is an LED driver board that can be used in a wide variety of applications, including as an interface with most customized floor plan annunciator boards. The 5880 can drive up to 40 LEDs and has one PZT controller. The 5880 also has eight inputs for dry contact monitoring. The following sub-sections describe hardware installation. Refer to Section 9 for programming information.

4.11.1 5880 Board Layout

Figure 4.37 shows the locations of screw terminals for connection to the panel and contact monitor wiring, pin connectors for connecting LEDs and the DIP switch for selecting an SBUS ID number for the 5880.

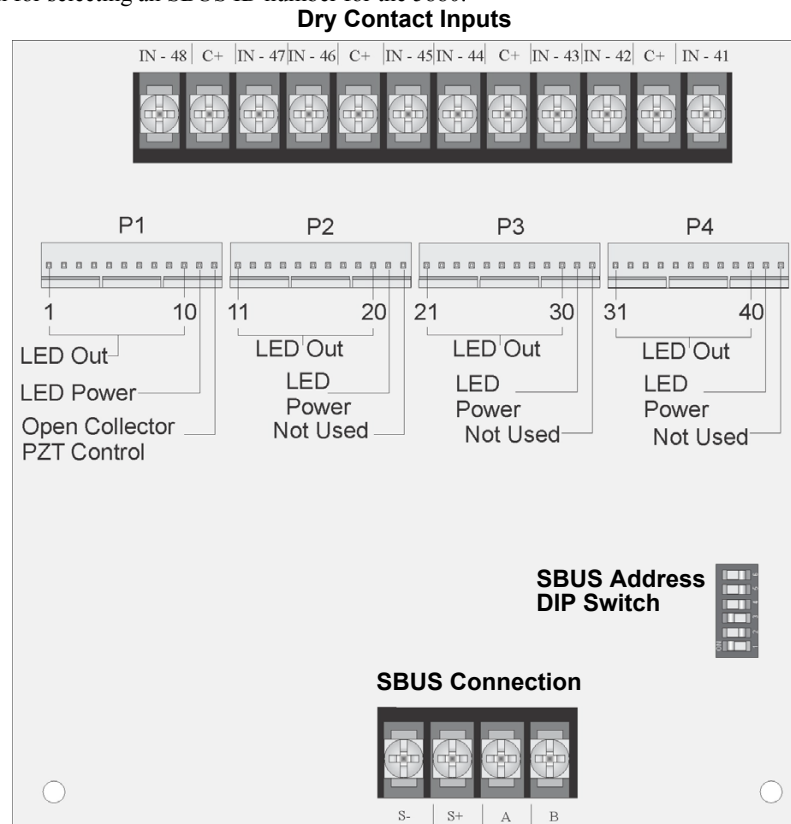

Figure 4.37 5880 Board Layout

4.11.2 FACP Connection

The 5880 connects to the panel via the SBUS. Make connections as shown in Figure 4.38. After the 5880 is connected to the panel, it must be added to the system. This programming step is described in Section 9.2.2.

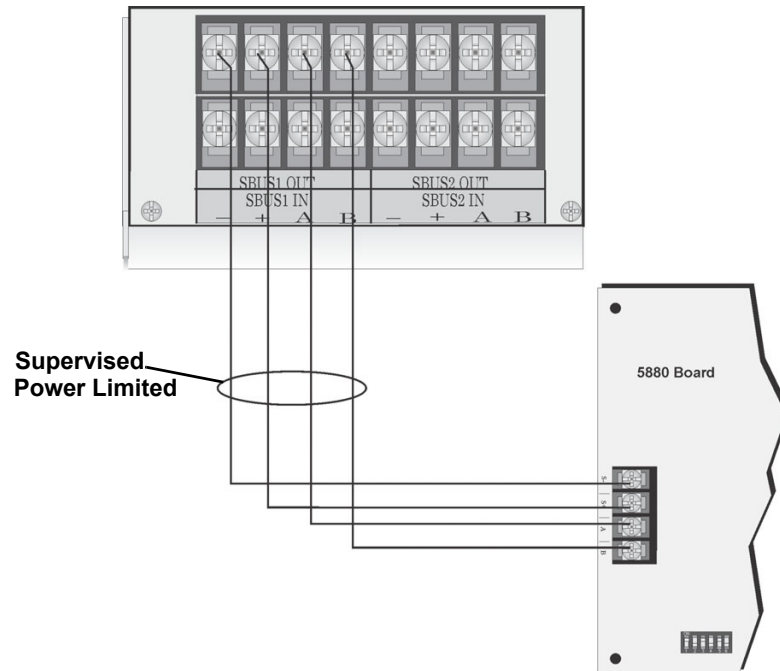

Figure 4.38 5880 Connection to Main Control Panel Assembly

4.11.3 LED Wiring

There are four 12-pin connectors on the 5880 board for connecting LEDs. Each LED gets its power from Pin 11. Internal resistors are sized so that there is approximately 10 mA of current for each LED; no series resistors are required. LED outputs can be mapped to output circuits. See Section 9.5.4 for programming details.

Wire the LEDs as shown in Figure 4.39.

On connector P1, Pin 12 is an open collector output for controlling a PZT. If used, the 5880 PZT will match the PZT pattern of the on-board or remote annunciator.



NOTE: The circuit connected to "Open Collector Output" (last pin on P1) must be current limited so that no more than 100 mA of current is allowed to flow into the open collector transistor.

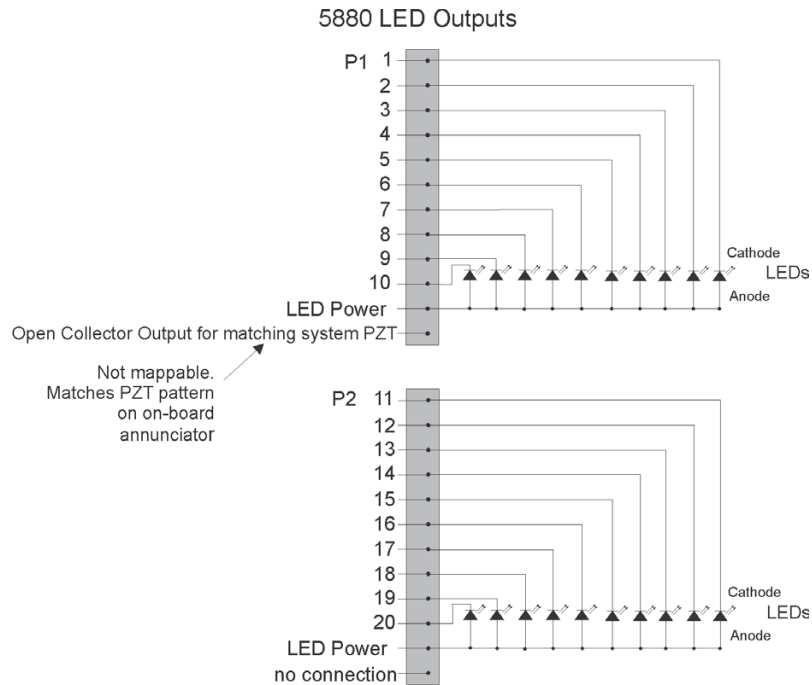

Connectors P3 and P4 wired same as P2.

Figure 4.39 5880 Board Layout

4.11.4 Dry Contact Wiring

The 8 input circuits on the 5880 board are for monitoring switch inputs. Any type of switch supported by the control panel can be used with the 5880. For example, you can use a 5880 to monitor pull stations, water flow, tamper, reset, or silence switches.

Wire dry contacts as shown in Figure 4.40. Notice grouping of terminals; power terminals are shared by two inputs.

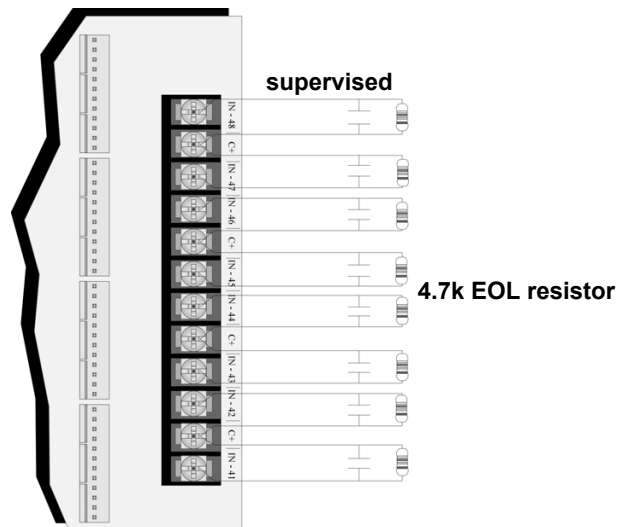

Figure 4.40 Dry Contact Wiring

4.12 5865-3 / 5865-4 LED Annunciator Installation

The 5865-3 and 5865-4 are LED annunciators. The 5865-4 has 30 mappable LEDs, remote fire system silence and fire system reset key switches, and a general system trouble LED. The 5865-3 has 30 mappable LEDs only. These are arranged as 15 pairs of red (typically used for alarm) and yellow (typically used for trouble) LEDs.

Installation of the 5865-3 and 5865-4 is identical. The key switches and the trouble LED follow the behavior of other system annunciators and do not require any installation steps. The following sub-sections describe how to install the 5865-3 and 5865-4 hardware. Refer to Section 9 for programming information.



NOTE: This manual uses "5865" when referring to aspects of the 5865-3 and 5865-4 that are common to both models.

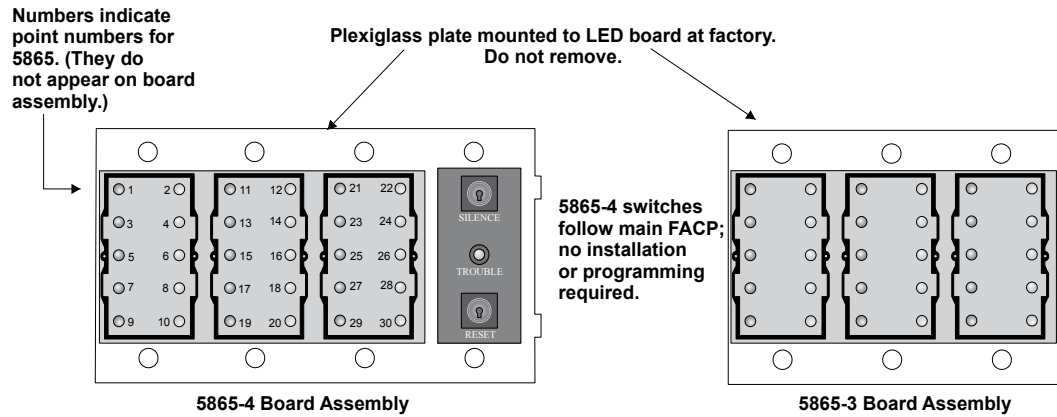

Figure 4.41 5865-3 and 5865-4 Assembly (front view)

4.12.1 FACP Connection

The 5865 connects to the panel via the SBUS. Make connections as shown in Figure 4.42. After the 5865 is connected to the panel, it must be added to the system. This programming step is described in Section 9.2.2.

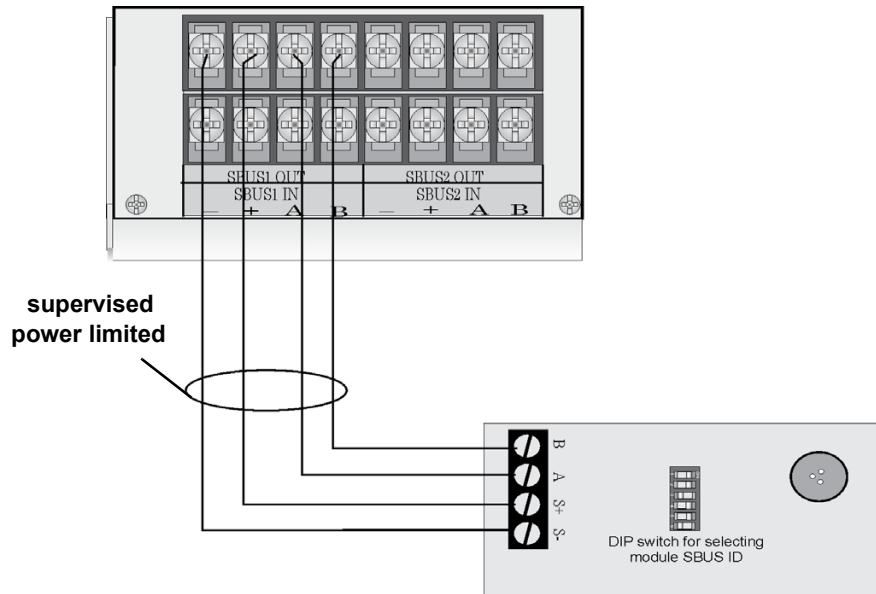

Figure 4.42 5865 Connection to the FACP

4.12.2 5865 Mounting

Mount the 5865-4 to a standard 4-gang electrical box. Mount the 5865-3 to a standard 3-gang electrical box. In Figure 4.43, the 5865-4 attached to a 4-gang box is used as an example.

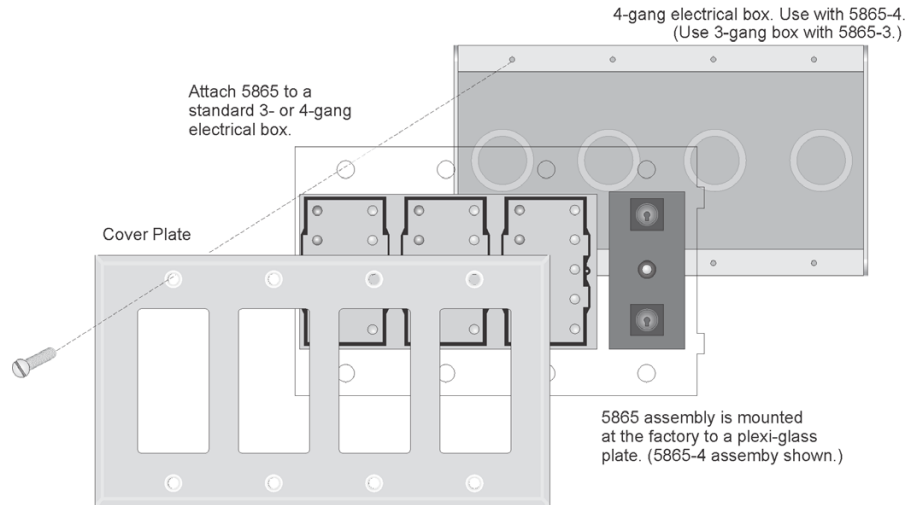

Figure 4.43 5865 Mounting Example

The 5865 ships with a set of zone description labels that can be inserted into the 5865 board assembly. These labels can be used in a typewriter or can be written on by hand. Slide the labels under the plexiglass as shown in Figure 4.44. The LEDs will show through the label when illuminated.

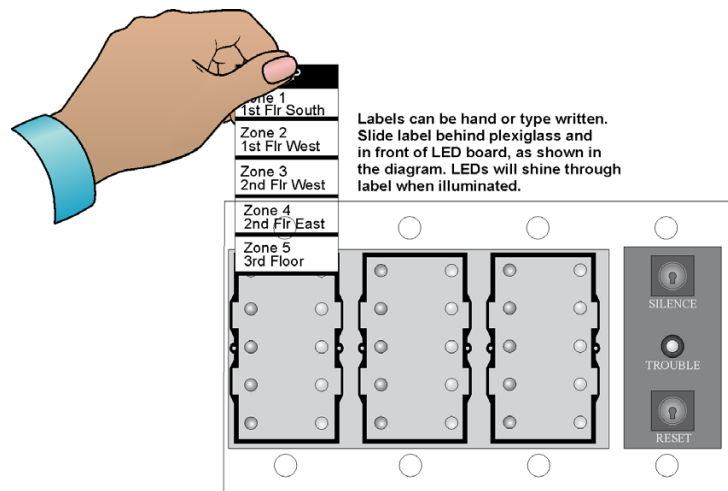

Figure 4.44 Inserting Zone Description Labels

4.13 Configuring SBUS Modules

This section describes how to configure any system hardware modules that have been added to the system.

4.13.1 Assigning SBUS Module IDs

SBUS devices on a panel are addressed from 1 to 63 and are connected to either SBUS 1 or SBUS 2. Although the addressing scheme allows 63 SBUS devices to be connected to a panel, the actual number is limited by current draw and SBUS bandwidth usage as discussed below. When installing a hardware module (see Table 4.1 for a list of compatible devices), you must use the DIP switches on the module to assign an ID# to the module. Address zero is an invalid address and is not allowed.

Figure 4.45 shows all possible DIP switch positions and their correlation to a numerical ID. For example, to select ID 2, place DIP switch 2 in the up or on position.

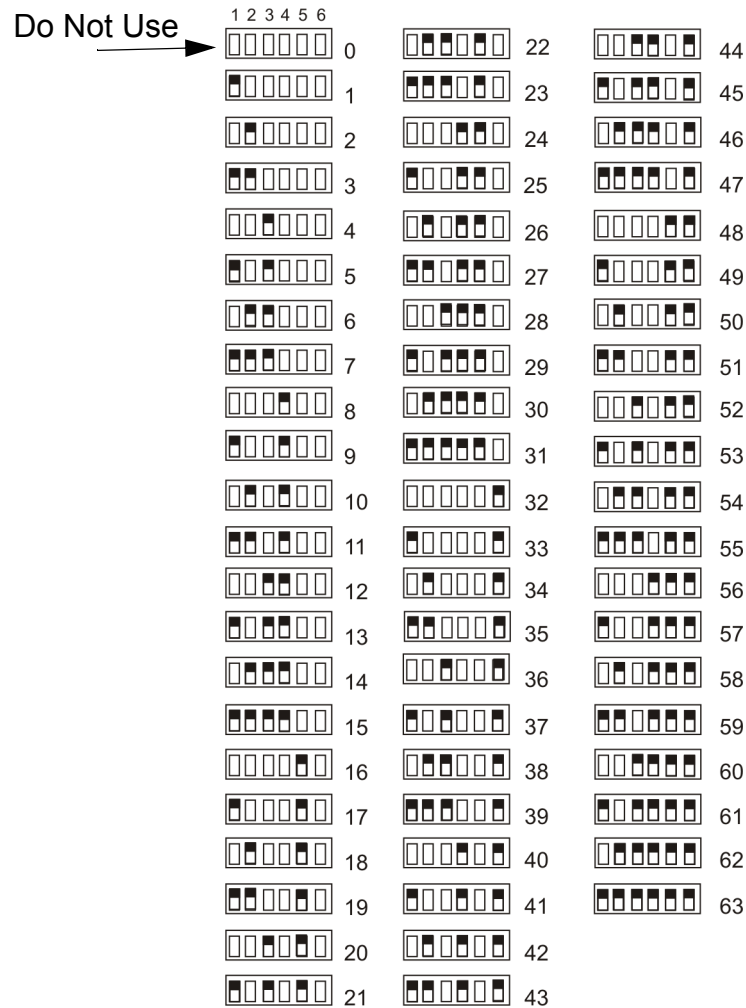

Figure 4.45 Possible SBUS module addresses

Refer to Section 9.2 to edit, add, delete, and view module list.

4.13.2 SBUS Bandwidth Considerations

Each SBUS device generates a certain amount of traffic on the SBUS. Generally, the amount of traffic generated depends on the type of SBUS device. To help you figure out the SBUS bandwidth usage of a given collection of devices, a tool is available on the Farenhyt website (www.farenhyt.com). The tool will serve as a guide to help determine how heavily loaded an SBUS is with respect to bandwidth. We recommend you use this tool if you plan to have more than eight SBUS devices per SBUS. Remember to include devices that are on RPS-1000 SBUS repeaters in your list of devices for SBUS bandwidth calculations. See Section 4.4.1.

4.14 Telephone Connection

Connect the telephone lines as shown in Figure 4.46. The Model 7860 phone cord is available from Honeywell for this purpose. If you do not use the model 7860 to connect to the phone lines, the wire used for the connection must be 26 AWG or larger diameter wire.

A number of programmable options are available for customizing telephone lines. These options are described in Section Phone Lines.

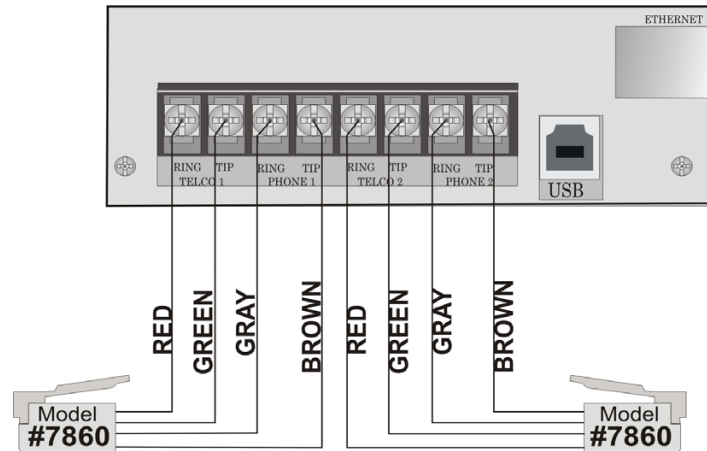

Figure 4.46 Connection of Telephone Lines

4.15 Flexputs™ I/O Circuits

The eight Flexput™ circuits are an innovative and versatile feature of the control panel. They can be used as: Class A or B notification circuits, Class A or B initiation circuits (either 2 or 4 wire detectors), or as auxiliary power (resettable, continuous, sounder base sync, or door holder).

The polarity of the Flexput terminals differs depending on whether the circuit is programmed as an input or an output circuit. If the circuit is programmed as an input circuit (for a detector or normally open contact) the X terminal is negative and O terminal is positive. If the circuit is programmed as an output circuit (Aux power or NAC) then the X terminal is positive and the O terminal is negative.

4.15.1 Conventional Notification Appliance

This sub-section of the manual explains how to install conventional notification appliances for Class A and Class B configurations.

Class B Notification Wiring

You must use an appliance from the list of compatible appliances in the “Compatible Devices” on page 202 at the back of this manual. To install a circuit:

1. Wire Class B Notification appliances as shown in Figure 4.47.
2. Configure the circuit through programming (see Section 9.5)

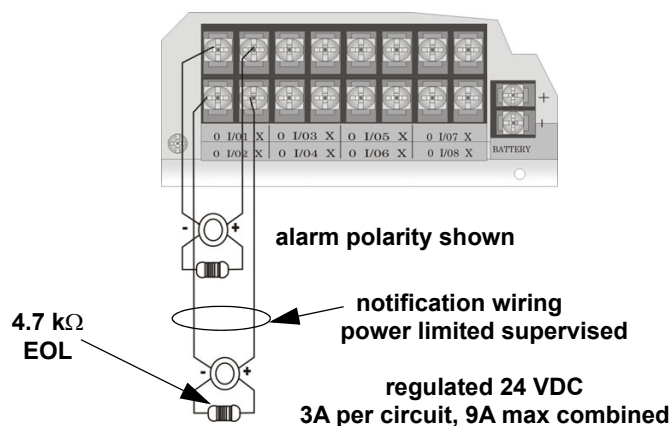

Figure 4.47 Class B Notification Appliance Circuit Wiring

Maximum voltage drop is 3V per Class B notification. See Table 4.4.

Current	Maximum Impedance
1.0A	3Ω
1.5A	2Ω
2.0A	1.5Ω

Table 4.4 Maximum Impedance Class B

Current	Maximum Impedance
2.5A	1.2Ω
3.0A	1.0Ω

Table 4.4 Maximum Impedance Class B

Class A Notification Wiring

You must use an appliance from the list of compatible appliances in Section A at the back of this manual.

To install a Class A notification appliance circuit:

1. Wire the Class A notification appliances as shown in Figure 4.48.



CAUTION: FOR PROPER SYSTEM SUPERVISION DO NOT USE LOOPED WIRE UNDER TERMINALS MARKED O AND X OF THE FLEXPOT CONNECTORS. BREAK WIRE RUNS TO PROVIDE SUPERVISION OF CONNECTIONS

2. Configure the circuit for Class A in programming (see Section 9.5).

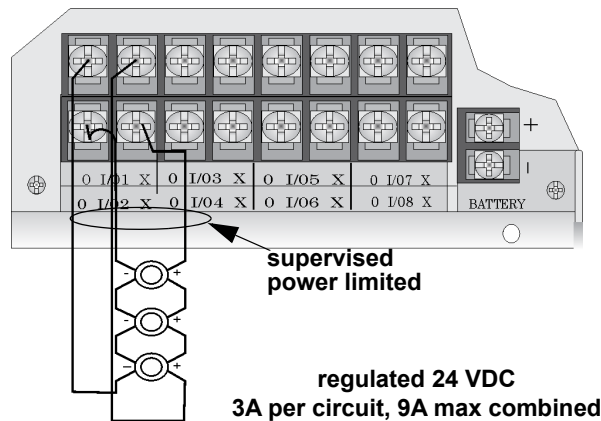

Figure 4.48 Class A Notification Appliance Circuit Configuration



NOTE: In programming any point that uses multiple Flexput circuits, the lowest Flexput circuit number is used to refer to the circuit pair. For example, Figure 4.48 uses both Flexput circuit 1 and 2, so in programming it would be referred to as point 1.

Maximum voltage drop is 3V per Class A circuit. See Table 4.5.

Current	Maximum Impedance
1.0A	3Ω
1.5A	2Ω
2.0A	1.5Ω
2.5A	1.2Ω
3.0A	1.0Ω

Table 4.5 Maximum Impedance Class A

4.15.2 Conventional Input Switch Circuits

This section of the manual explains how to install conventional initiating devices for Class A or Class B configurations.

Class B Inputs

You can connect conventional Class B switches, such as waterflow switches and pull stations, directly to the Flexput circuits of the control panel.

To install a Class B switch:

1. Wire the Class B switch as shown in Figure 4.49.

- Configure the circuit through programming (see Section 9.5).

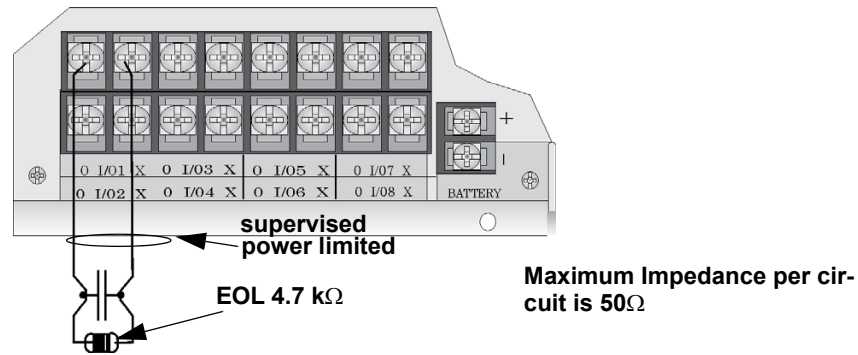

Figure 4.49 Class B Input Switches

Class A Inputs

You can connect conventional Class A switches, such as waterflow switches and pull stations, directly to the Flexput circuits of the control panel.

To install a Class A switch:

- Wire the Class A switch as shown in Figure 4.50.
- Configure the circuit through programming (see Section 9.5).

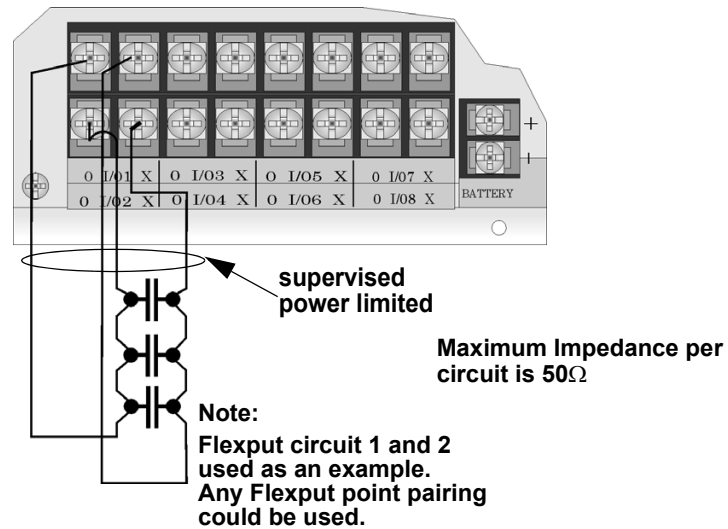

Figure 4.50 Class A initiating Switches



NOTE: In programming any point that uses multiple Flexput circuits, the lowest Flexput circuit number is used to refer to the circuit pair. For example, Figure 4.50 uses both Flexput circuit 1 and 2, so in programming it would be referred to as point 1.

4.15.3 Installing 2-Wire Smoke Detectors

Any compatible UL listed two-wire smoke detector can be used with the control panel (see Section A for list of compatible smoke detectors). Figure 4.51 and Figure 4.52 illustrate how to connect a UL listed 2-wire detector to the control panel.

Installing 2-Wire Class B Smoke Detectors

To install a Class B two-wire smoke detector, wire as shown in Figure 4.51.

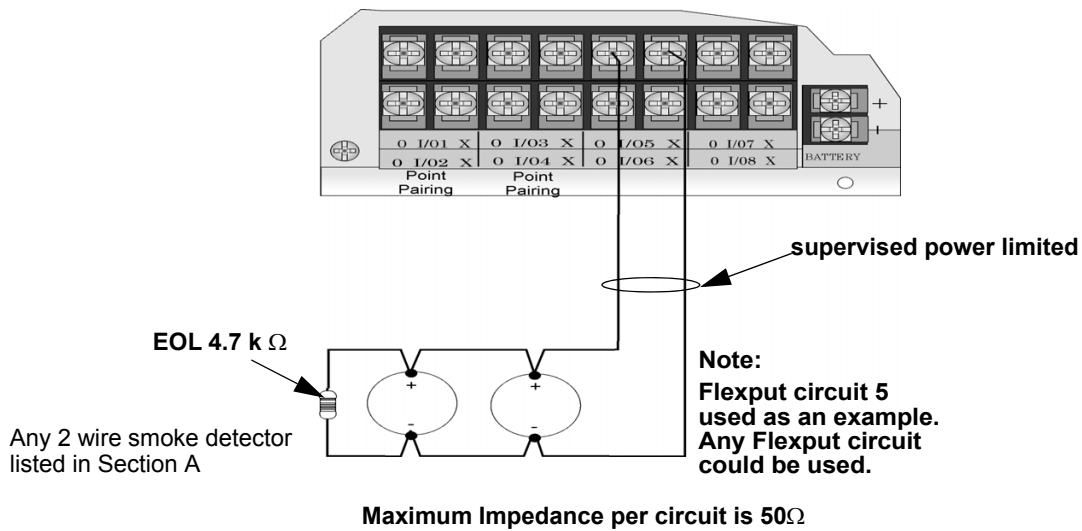

Figure 4.51 Two-Wire Class B Smoke Detector

Installing 2-Wire Class A Smoke Detectors

To install a Class A two-wire smoke detector, wire as shown in Figure 4.52.

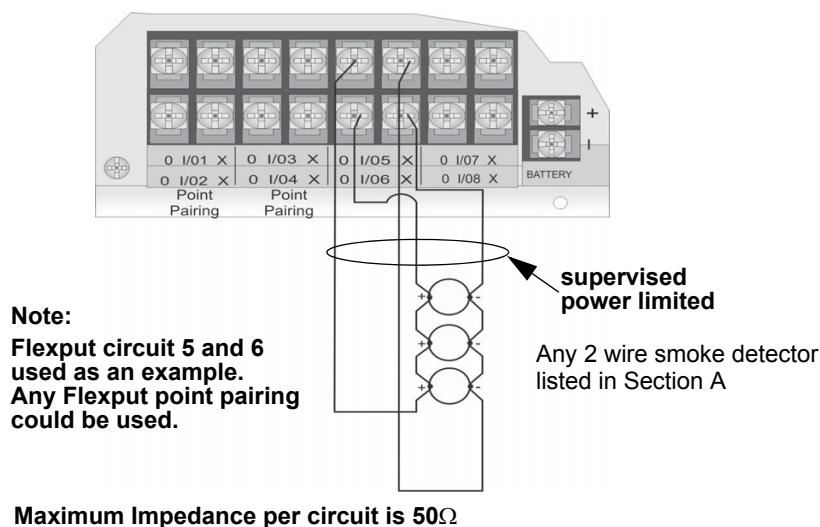

Figure 4.52 Two-Wire Class A Smoke Detector Connections



NOTE: In programming any point that uses multiple Flexput circuits, the lowest Flexput circuit number is used to refer to the circuit pair. For example, Figure 4.52 uses both Flexput circuit 5 and 6, so in programming it would be referred to as point 5

4.15.4 Installing 4-Wire Smoke Detectors

Any compatible UL listed four-wire smoke detector can be used with the control panel (see Section A for list of compatible smoke detectors). Figure 4.53 and Figure 4.54 illustrate how to connect a UL listed four-wire detector to the control panel.

Installing a Class B 4-Wire Smoke Detectors

Figure 4.53 illustrates how to install a 4-wire Class B smoke detector.

Conventions used for wiring 4-wire Class B loops:

1. Up to four Class B 4-wire smoke detector loops can be connected to the control panel at once.
2. Each Class B loop input is paired with a unique power source as shown in Figure 4.53.

- Each loop gets smoke power from the even numbered Flexput circuit and the contact input is connected to the odd numbered Flexput circuit.

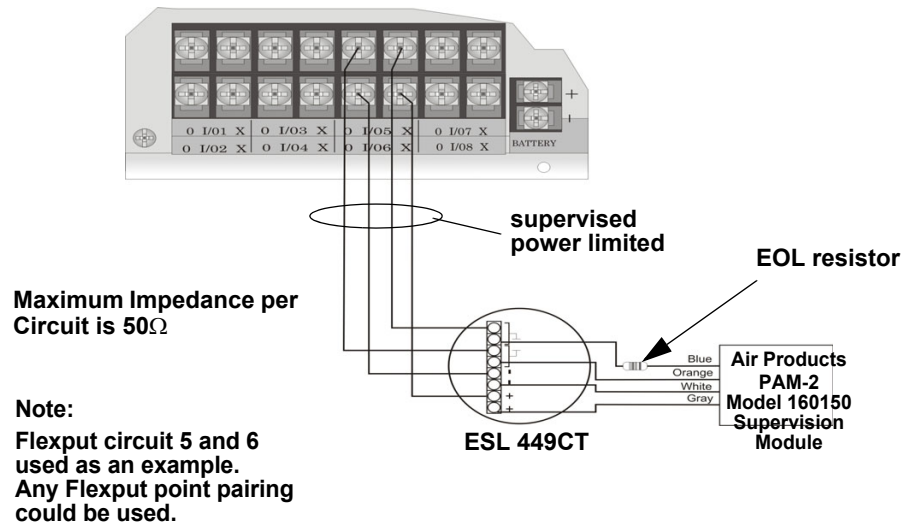

Figure 4.53 Class B 4-Wire Smoke Detector Connections



NOTE: In programming any point that uses multiple Flexput circuits, the lowest Flexput circuit number is used to refer to the circuit pair. For example, Figure 4.53 uses both Flexput circuit 5 and 6, so in programming it would be referred to as point 5

Installing 4-Wire Class A Smoke Detectors

Figure 4.54 illustrates how to install 4-wire Class A detectors. Conventions used for wiring 4-wire Class A loops:

- Up to two Class A 4-wire loops can be connected to the control panel at once.
- Smoke power is supplied to each Class A loop as shown in Figure 4.54.

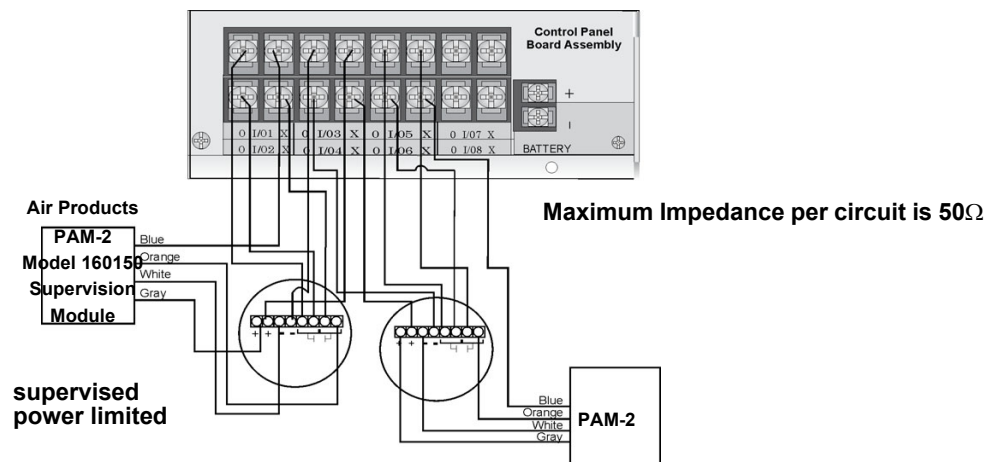

Figure 4.54 Class A 4-Wire Smoke Detector Connections

NOTE: In programming any point that uses multiple Flexput circuits are always referred to as the lowest Flexput circuit number used. For example, Figure 4.54 uses Flexput circuits 1, 2, 3 together and 4, 5, 6 together. In programming (1, 2, 3) would be referred to as point 1, and (4, 5, 6) would be referred to as point 4.

4.15.5 Auxiliary Power Installation

Flexput Circuits 1-8 on the control panel can be used as auxiliary power circuits. The three types of auxiliary power available are:

- Door Holder Power
- Constant Power
- Resettable Power
- Sounder Sync Power

Auxiliary power circuits are power limited. Each circuit can source up to 3A (total current for all Flexput circuits must not exceed 9.0 A in alarm, and 6A when used as constant auxiliary power in normal standby).

To install an auxiliary power circuit:

1. Wire the Flexput circuit(s) that will be used for auxiliary power. See Figure 4.55 for location of Flexput circuits.
2. Configure the auxiliary power output through programming (see Section 9.5).

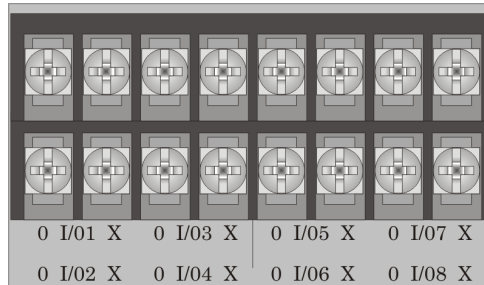

When used as auxiliary power, terminals labeled “O” are negative, terminals labeled “X” are positive

Figure 4.55 Flexput Circuit Location

Door Holder Power

Door holder power is intended for fire door applications. When there are no fire system alarms in the system and the panel has AC power, door holder circuits have 24 volt power present at their terminals. Any fire system alarm will cause power to disconnect. Power will be re-applied when the fire system is reset. If AC power is not present, the auxiliary door holder power will be disconnected to conserve the battery backup. When AC power is restored, power is immediately restored to the door holder circuits.

Use a UL listed door holder such as ESL DHX-1224, for this application. See Table for compatible door holder list.

Constant Power

Use constant power for applications that require a constant auxiliary power source. Power is always present at constant circuits.

Resettable Power

Resettable power is typically used to power beam detectors, flame detectors and conventional 4-wire smoke detectors. For circuits selected as Resettable, 24 volt power is always present at the terminals unless a fire system reset occurs. If a fire system reset occurs, power is disconnected from the terminals for 30 seconds, then re-applied. See Appendix A.3 for compatible four wire smoke detectors.

Sounder Sync Power

Sounder Sync Power continuously outputs the System Sensor synchronization pattern and is intended for use with B200S sounder bases.

4.16 On-Board Relays (Conventional)

The control panel has two built-in programmable relays and a built-in trouble relay. All relays are Form C rated at 2.5 A @ 24VDC.

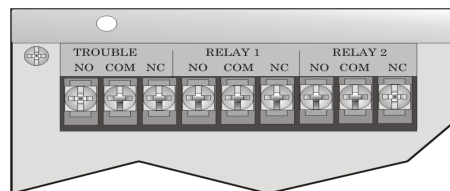

Figure 4.56 Location of Conventional Relay Circuits

4.16.1 Trouble Relay

The control panel has a dedicated Form C trouble relay built in. The relay provides a normally open and a normally closed contact. The trouble relay will deactivate under any trouble condition.



NOTE: The NC contact is the relay contact that is closed when the panel has power and there are no trouble conditions

4.16.2 Programmable Relays

The control panel has two Form C programmable relays built in. Each relay provides a normally open and a normally closed contact. To install one or two programmable relays, follow these steps.

1. Wire Relay 1 and/or Relay 2 as needed for your application. See Figure 4.56 for the location of the relay terminals.
2. Configure the relay through programming (see Section 9.5).

4.17 Remote Station Applications

4.17.1 Keltron Model 3158 Installation

The control panel is compatible with Keltron Model 3158, used for direct connection to a Keltron receiver. The 3158 reports alarms, supervisories, and troubles.

The steps for connecting the 3158 to the control panel. Refer to the 3158 installation instructions for complete information.

1. Wire the 3158 to the control panel as shown in the connection list.
2. Wire the 3158 within 20 feet of the control panel. Wiring must be enclosed in conduit.
3. Program control panel Relay 1 for alarm.
4. Program Flexput circuit 5 for alarm.
5. Program Flexput circuit 6 for supervisory non latching.

Terminal #	Connects To
3158 Term. 1	To Keltron receiving equipment
3158 Term. 2	To Keltron receiving equipment
3158 Term. 3	Earth ground
3158 Term. 4	Not used; no connection.
3158 Term. 5	Control panel SBUS OUT +
3158 Term. 6	Control panel SBUS OUT –
3158 Term. 7	Control panel I/O5 O

Terminal #	Connects To
3158 Term. 8	Control panel Relay 1 COM
3158 Term. 9	Control panel I/O6 O
3158 Term. 10	Control panel I/O6 X
Control panel I/O5 X	Control panel Relay 1 NO
Control panel Relay 1 COM	Control panel Trouble COM
Control panel Relay 1 NO	Control panel Trouble NC

Table 4.6 Keltron 3158 to Control Panel Connections

4.17.2 City Box Connection Using the 5220 Module

This section describes how to connect the control panel to a local energy municipal fire alarm box or “city box” as required by NFPA 72 Auxiliary Protected Fire Alarm systems for fire alarm service. The city (master) box is an enclosure that contains a manually operated transmitter used to send an alarm to the municipal communication center which houses the central operating part of the fire alarm system.

City Box Standby Current: 0 (Notification supervision current accounted for in control panel draw.)

Alarm Current: 1 Amp for 1 second 27.2 VDC max.

The maximum coil and wire resistance (combined) must not exceed 30 ohms.

To install the 5220 for city box connection:

1. Use one of the knockouts on the right side of the control panel to connect the 5220 using a short piece of conduit (must not exceed 20 feet in length).
2. Wire the 5220 to the control panel as shown in Figure 4.57. This drawing also shows how to connect the city box coil to terminals 3 and 4 on the 5220. Do not install an EOL resistor in the terminals of the Flexput circuit used for this application.
3. Connect earth ground wire to the 5220 chassis with mounting screw.

4. Program the Flexput circuit as a notification circuit, Refer to Section 9.5.3. Assign this Flexput to an output group that is mapped to activate with non silenceable constant output in response to a system general alarm condition. It is not possible to reset the remote indication until you clear the condition and reset the control panel.

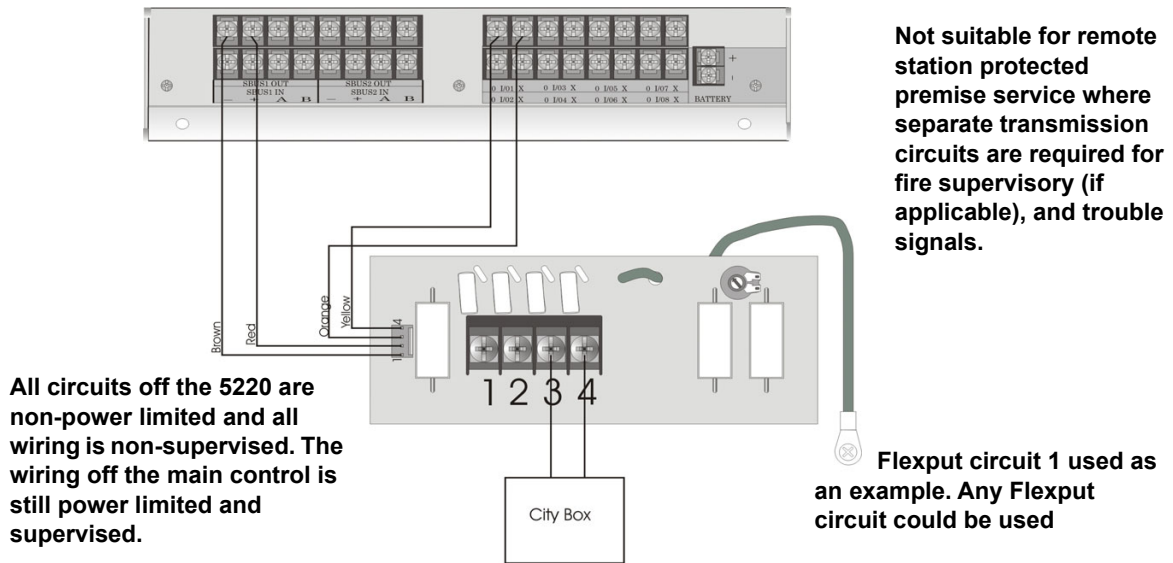

Figure 4.57 City Box Connection

4.17.3 Using the Addressable Relay Module for City Box Connection

Wire the Relay module as shown in Figure 4.58.

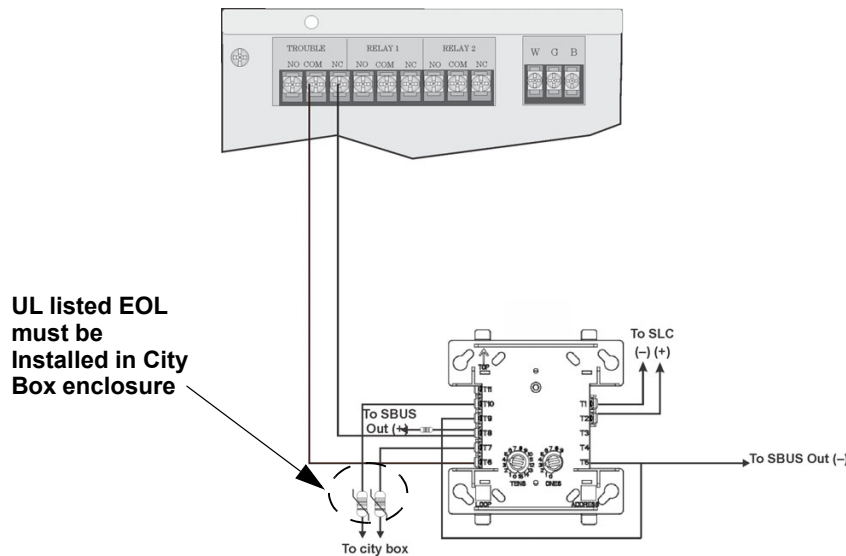

Figure 4.58 Relay Module for City Box Connection

4.17.4 NFPA 72 Polarity Reversal



NOTE: Intended for connection to a polarity reversal circuit of a control unit at the protected premises having compatible rating.

Using the 5220 Module

When the 5220 is wired and programmed for polarity reversal, it reports alarm and trouble events to a remote site. Alarms will override trouble conditions and it will not be possible to reset the remote indicator until the condition is cleared and the control panel is reset.

If an alarm condition occurs, the alarm relay will close, overriding the trouble condition.

Standby Current: 100 mA, 24 VDC

Alarm: 100 mA, 24 VDC

To install the 5220 for polarity reversal, follow the steps below:

1. Locate the knockout on the right side of the control panel cabinet to connect the 5220 using a short piece of conduit (must not exceed 20 feet in length).
2. Wire the 5220 to the control panel using the four-wire pigtail provided as shown in Figure 4.59. This diagram also shows how to connect the 5220 to the remote indicator. Do not install an EOL resistor in the terminals of the Flexput circuit used for this application.
3. Connect earth ground wire to the 5220 chassis with mounting screw.
4. Program the Flexput circuit as a notification circuit, refer to Section 9.5.3. Assign this Flexput to an output group that is mapped to activate with non silenceable constant output in response to a system general alarm condition.
5. If necessary, adjust loop current using the potentiometer (R10) on the 5220 board. Normal loop current is 2-to-8 mA with a 1k ohm remote station receiving unit. Maximum loop resistance is 3k ohm.

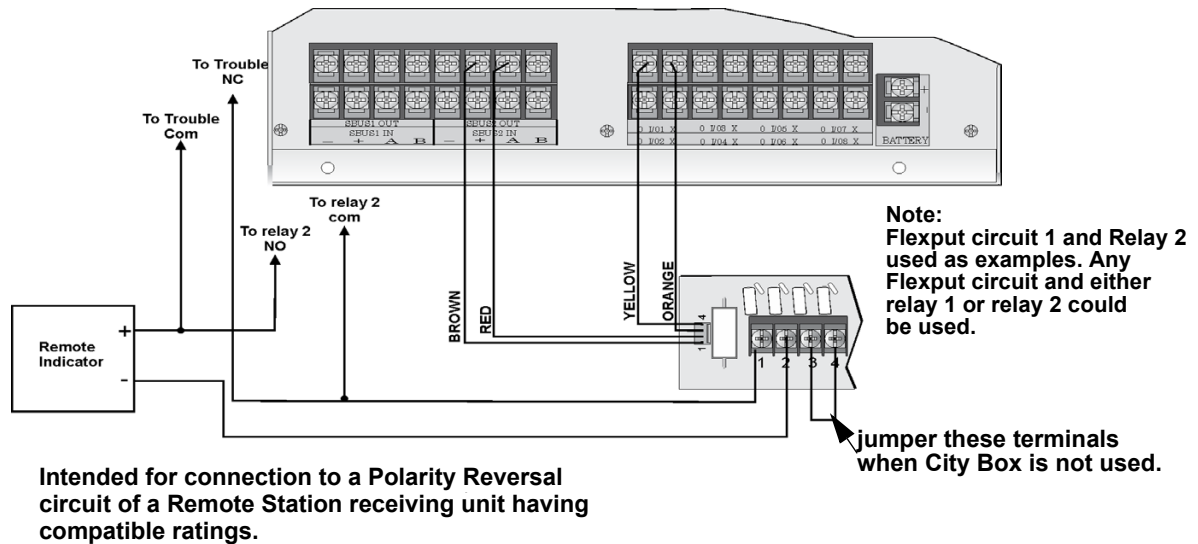

Figure 4.59 Polarity Reversal Connection Using the 5220 Module

Using the 7644-L8 Module

When the 7644-L8 is used for polarity reversal, it allows alarm and trouble events to be reported to a remote site. Alarms will override trouble conditions and it will not be possible to reset the remote indicator until the condition is cleared and the control panel is reset.

To install the 7644-L8 for polarity reversal:

1. Wire the 7644-L8 to the control panel as shown in Figure 4.60. Do not install an EOL resistor on the terminals of the Flexput circuit used.



NOTE: Use only Flexput circuits on the control panel for reverse polarity.

2. Program the Flexput circuit as a notification circuit. See Section 9.5.3.
3. Map the group to activate non silenceable, constant on in response to a system general alarm, and to disconnect in response to a system trouble.

- Intended for connection to a polarity reversal circuit of a remote station receiving unit having compatible rating.

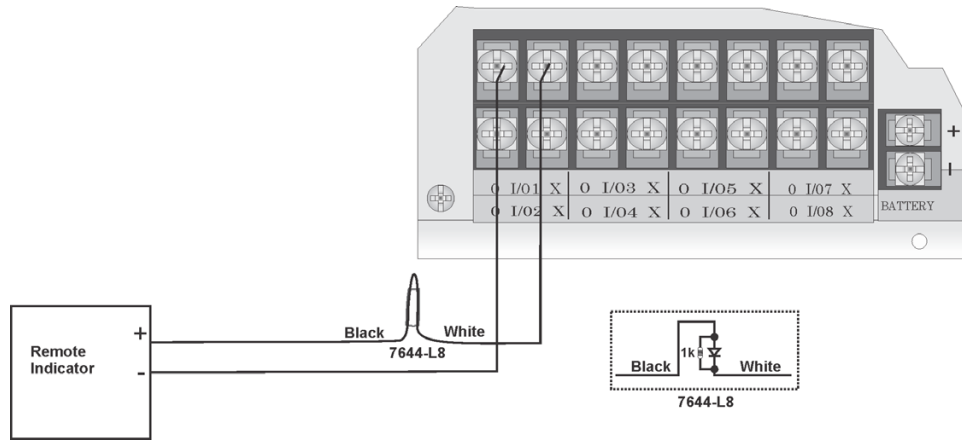

Figure 4.60 Polarity Reversal Connection Using the 7644-L8

4.17.5 Transmitter Activated by Dry Contacts

This section describes the connection of a UL 864 listed remote station transmitter to the IFP-2100/ECS dry relay contacts. The IFP-2100/ECS FACP contacts must be supervised by the remote station transmitter module using end-of-line resistors (ELRs) with a value determined by the transmitter manufacturer. Power is also provided by the remote station transmitter manufacturer. Refer to the remote station transmitter manufacturer’s manual for details.

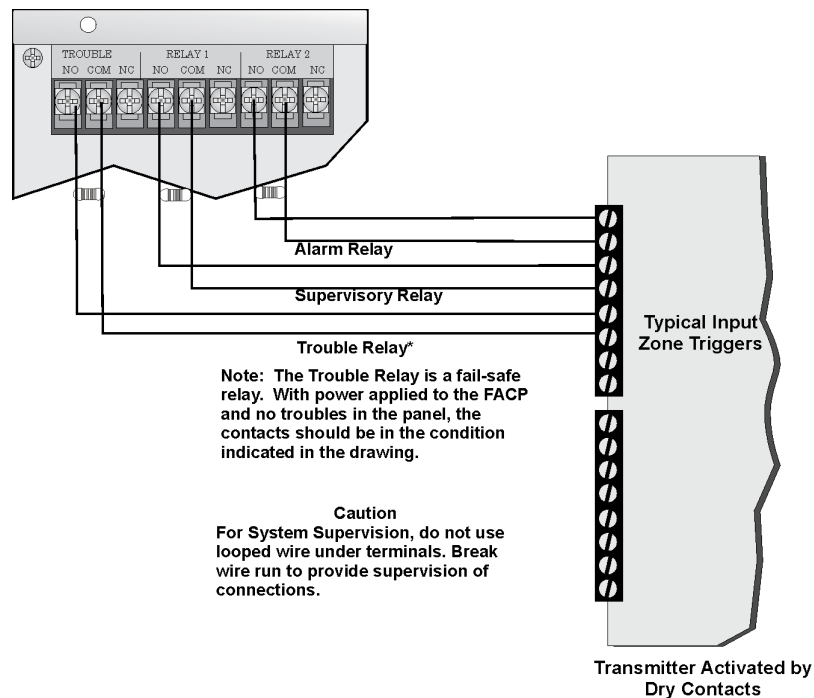

Figure 4.61 Transmitter Activated by Dry Contacts

Section 5: Networking

5.1 Network System Hardware Features

IFP-2100/ECS panels can be networked to create a virtual system that is larger than 2100 addressable points. Each additional IFP-2100/ECS or RFP-2100 provides another 2100 addressable points to the network total. For example, a network of 32- IFP-2100/ECS panels provides a maximum addressable point capacity of 67,200 points (2100 x 32 = 67,200).

5.1.1 Networked Sites

A networked site is a logical group of IFP-2100/ECS and/or RFP-2100 panels that behave as though the logical group is one large control panel. Each building is referred to as a “site.” All panels in a site operate as a single panel. The control functions like reset, silence and alarm activation operate across the entire site. There can be one or more logical sites within a networked system. The maximum number of sites within a network system is limited to 32 panels in the network with each site comprised of only one panel.

5.1.2 Wiring Options to Connect Networked Panels

1. Fiber Optic Single Mode - must use the SK-NIC and SK-FSL for up to 30dB loss of signal separation. SK-FSL connects to the network using 9/125 micron single-mode fiber
2. Fiber Optic Multi-Mode - must use the SK-NIC and SK-FML for up to 8dB loss of signal separation. SK-FML connects to the network using 62.5/125 micron multi-mode fiber
3. Twisted Pair Copper Wire - must use the SK-NIC to provide up to 3000 feet of separation.

All methods of panel connectivity can be used within the same networked system. The network architecture provides true peer to peer capability allowing network survivability for all hardware that remains operational in the event of partial system failure.

5.2 Model RFP-2100

The model RFP-2100 provides the same power and point capacity of an IFP-2100/ECS panel, but does not include any user interface. It is used in networked systems where added power and/or point capacity is required but where additional user interface is not needed.

5.3 Network Wiring

When networking a group of IFP-2100/ECS and/or RFP-2100s, you must use the SK-NIC to link the panels together. See Figure 5.1 and Figure 5.2, for Internal mounting or external mounting of SK-NIC option.

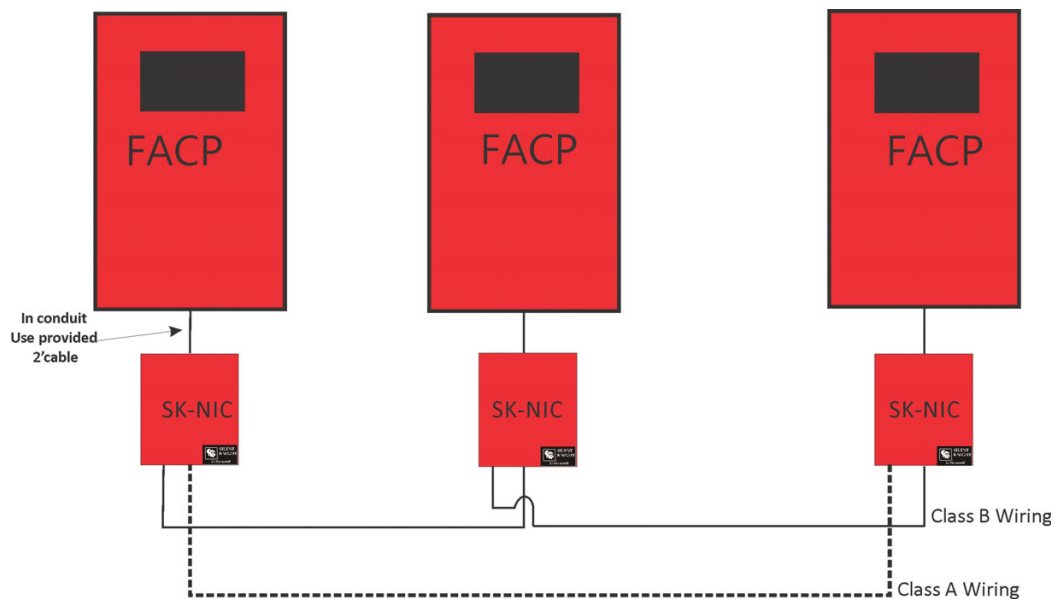

Figure 5.1 External SK-NIC Wiring Option

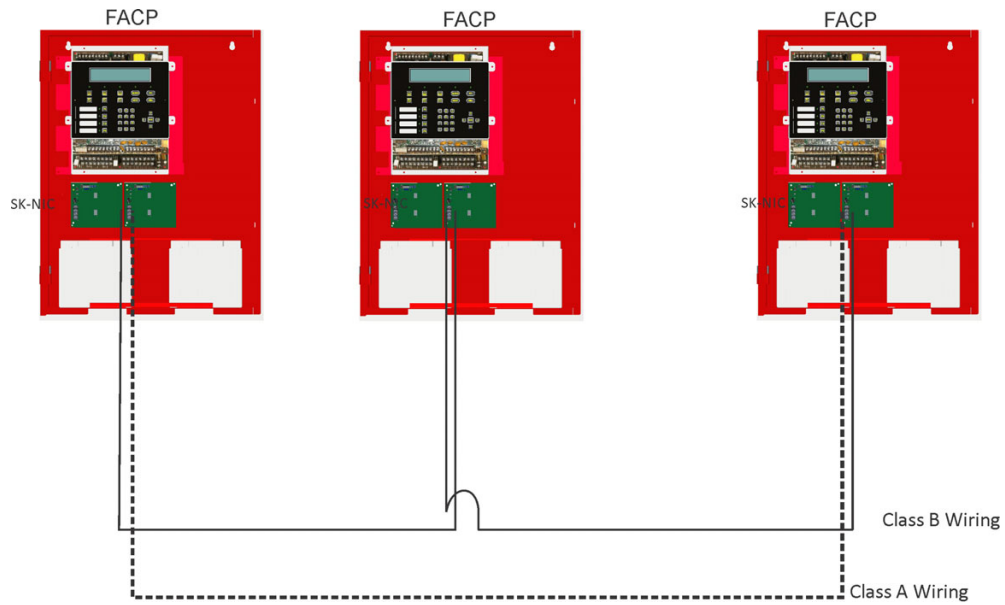

Figure 5.2 Internal SK-NIC Wiring Option

5.4 SK-NIC Wiring Options

Networking a group of IFP-2100/ECS requires the use of a network interface card with each panel. The SK-NIC connects to other networked units using unshielded, twisted-pair wiring or fiber optic cable.

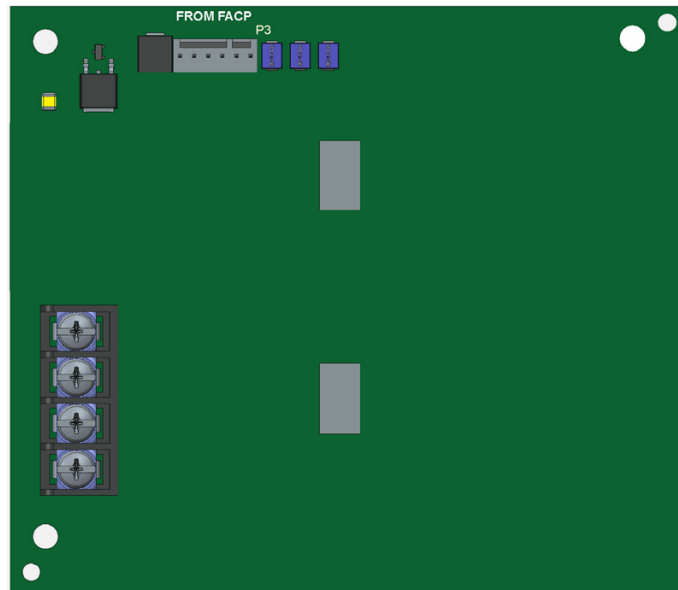

Figure 5.3 SK-NIC Network Interface Card

5.4.1 Fiber Loop Modules

Two types of fiber optic modules are available to use to transmit and receive communication with the SK-NIC. See Figure 5.4 For more information see SK-FML /SK-FSL installation sheet P/N LS10178-001SK-E.

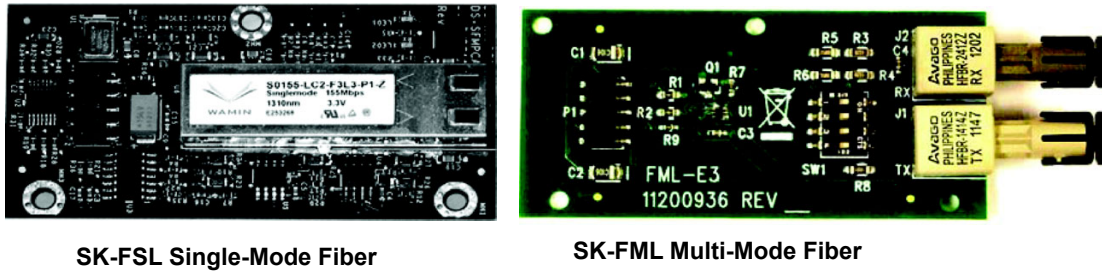

Figure 5.4 Types Fiber Loop Modules

The SK-FML (Fiber-Optic Multi-Mode) and SK-FSL (Fiber-Optic Single-Mode) are plug-in fiber loop modules. The two types of fiber optic modules are used as one channel to transmit or receive communications with the SK-NIC, ARCNET communication circuit.

The following describe the two types of fiber optic modules.

- The SK-FML is a fiber module that allows the multi-mode fiber to network between nodes.
- The SK-FSL is a fiber module that allows the single-mode fiber to network between nodes.

Each fiber loop module can Transmit (TX) and Receive (RX) fiber-optic cable connecting to the SK-NIC. Up to two fiber loop cards can be added to the SK-NIC, and both cards may be combined in the same configuration. See Figure 5.5.

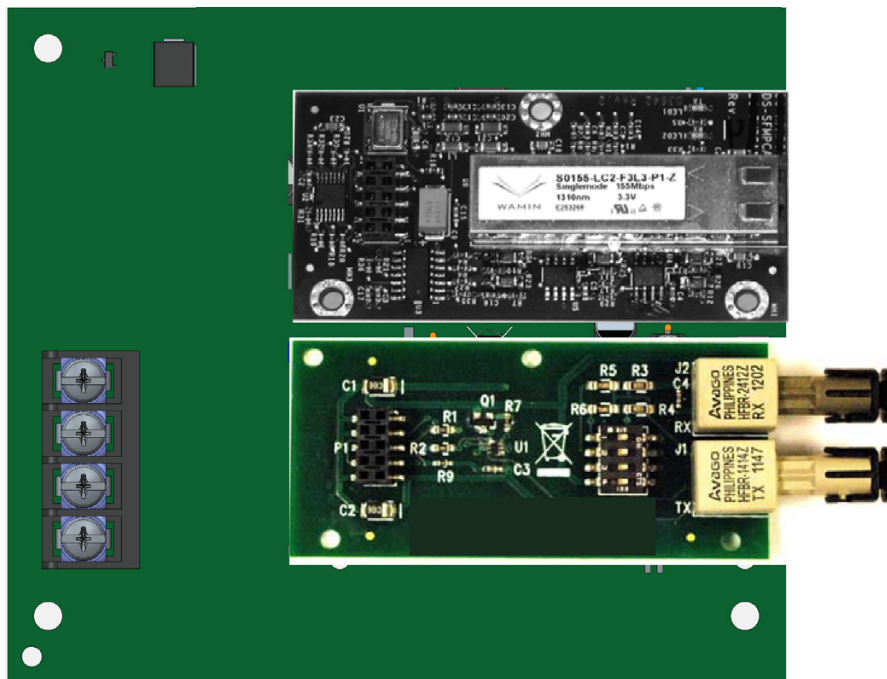

Figure 5.5 SK-NIC with Fiber Loop Modules

Accessory Mounting Kits

SK-NIC can be mounted within the IFP-2100/ECS cabinet or in the SK-NIC-KIT accessory cabinet. The accessory kits are available if you want to install the SK-NIC outside of the IFP-2100/ECS cabinet. The accessory kit part number is:

1. SK-NIC-KIT- which includes the SK-NIC, a small cabinet with door, cable, and mounting hardware.

5.4.2 SK-NIC Installation

The SK-NIC is designed to mount on one of the SLC expander standoff sets inside the cabinet or remotely using the accessory cabinet. Use the following steps to mount the SK-NIC inside the IFP-2100/ECS.

1. Place the SK-NIC on one of the SLC expander standoff sets.

2. Use the 6-pin cable included with SK-NIC to connect the IFP-2100/ECS to the SK-NIC. Connect the SK-NIC to the pin connector on the control panel labeled Data Network. See Figure 5.6.

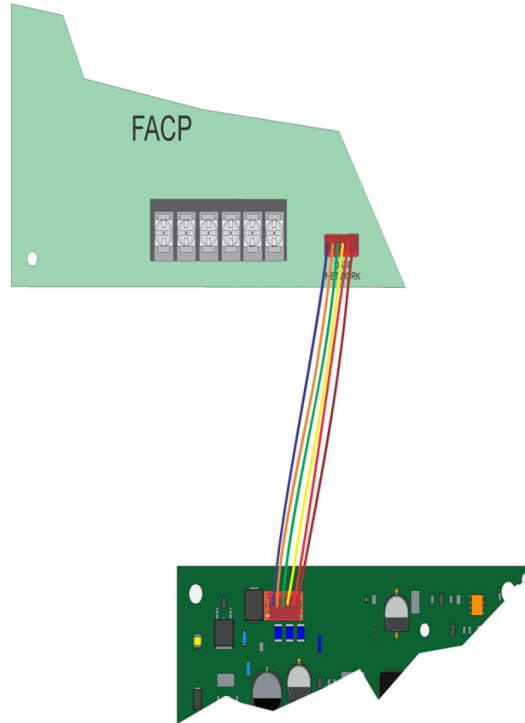

Figure 5.6 Panel to SK-NIC connection

3. Each SK-NIC has the ability to monitor for earth ground faults on the twisted pairs connected to Port 1 of its terminal block TB2. Earth fault detection for any wiring at Port 2 of TB2 is done at the next/previous SK-NIC due to these wiring connections being connected to Port 1 of TB2 at the next/previous SK-NIC.
4. Unused optic ports on fiber loop modules must have their dust caps placed on the port.
5. Based on the type of data medium chosen, run the twisted pair wiring/fiber optic cable to the next SK-NIC using a class B or class A wiring method. A combination of both medium types can be used. See Figure 5.7, Figure 5.8, Figure 5.9, and Figure 5.10 for SK-NIC wiring examples.

■ **To mount the SK-NIC remotely:**

Follow the steps above except; The 6-pin cable that runs from the SK-NIC to the IFP-2100/ECS, must be run in conduit. See Figure 5.1.

Unshielded Twisted Pair Wiring between Multiple Panels

Unshielded twisted pair wiring between multiple panels is shown in Figure 5.7. Class A wiring is shown with a dotted line.

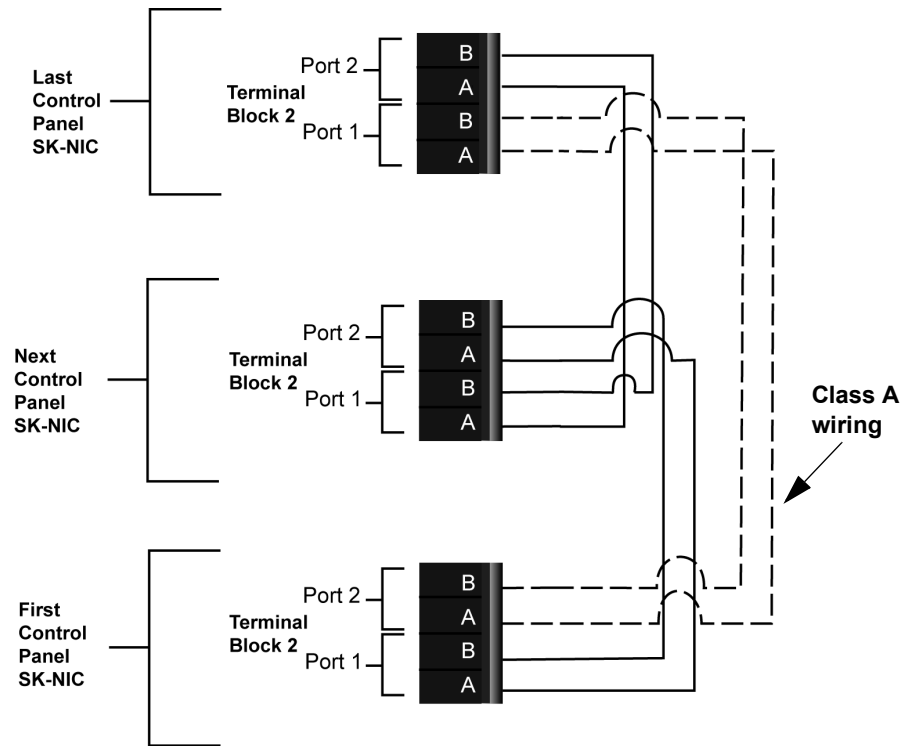

Figure 5.7 Twisted Pair Wiring Configuration

Fiber Optic Multi-Mode Wiring between Multiple Panels

Fiber optic cable between multiple panels is shown in Figure 5.8. Class A is shown with a dotted line.

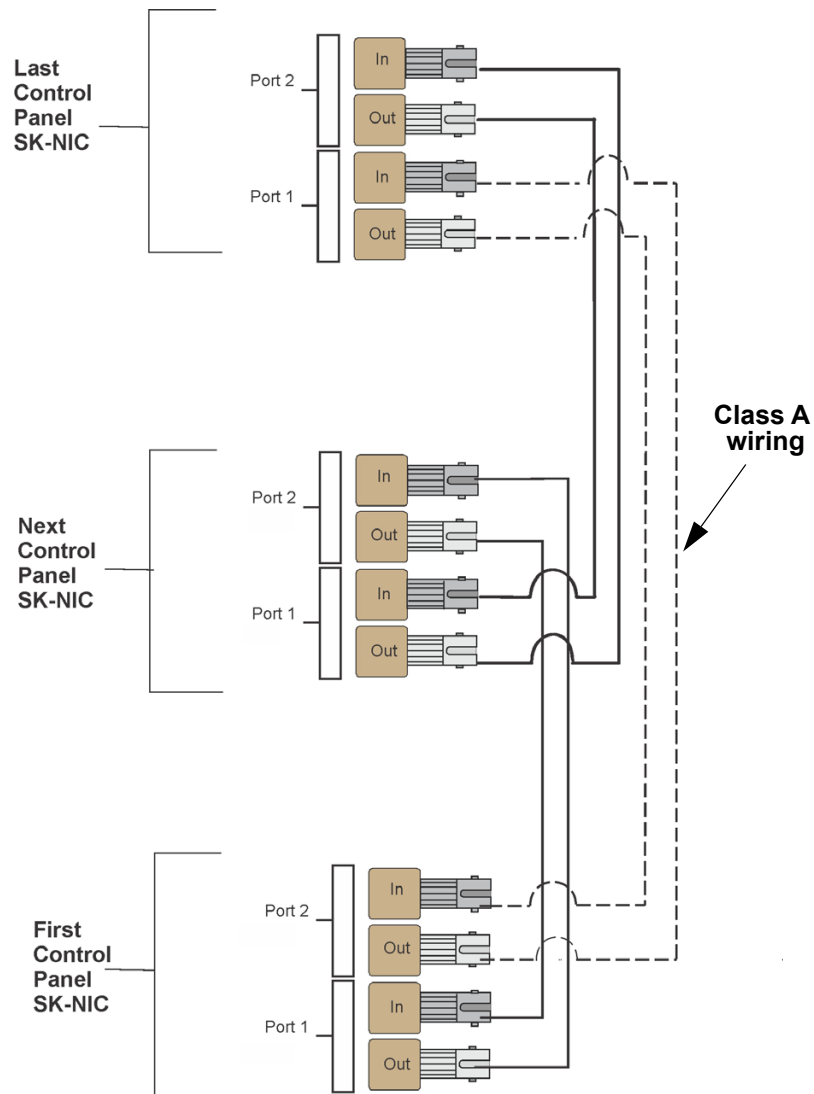

Figure 5.8 Fiber Optic Wiring Multi-Mode Example

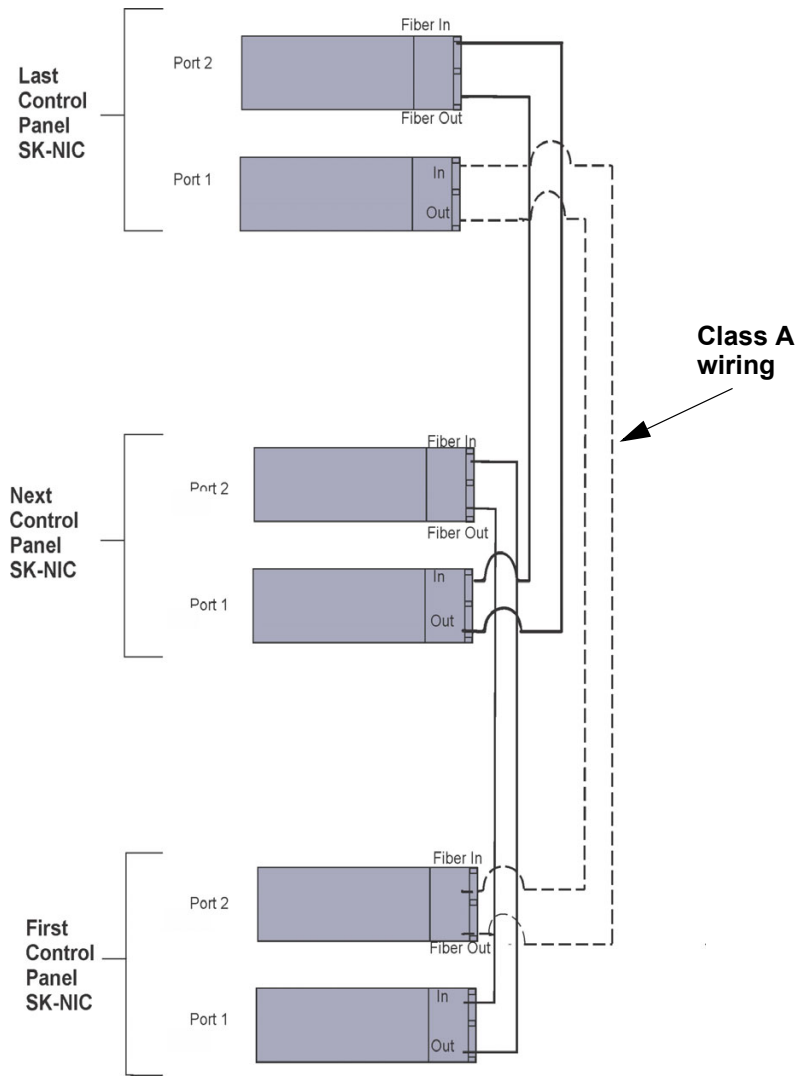

Figure 5.9 Fiber Optic Wiring Single-Mode Example

Fiber Optic and Twisted Pair Wiring between Multiple Panels

A mixture of fiber optic cable and twisted pair wiring between multiple panels is shown in Figure 5.10. Class A cabling is shown with dotted line.

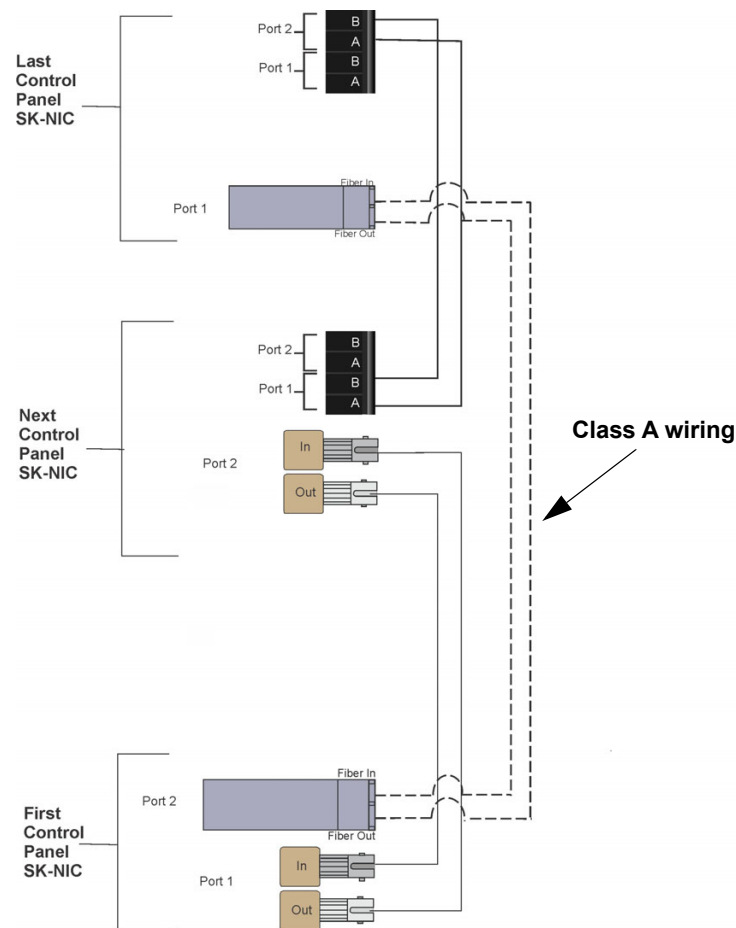

Figure 5.10 Twisted Pair and Fiber Optic Combination Wiring Example

5.5 Setting the Network ID for each Panel



NOTE: It is important that much thought is given when choosing the network IDs for each panel. It is difficult to change the IDs once panel programming has begun.

The network ID for each panel is set using DIP switch positions 1 through 5. See Figure 5.11 below for possible DIP switch settings.

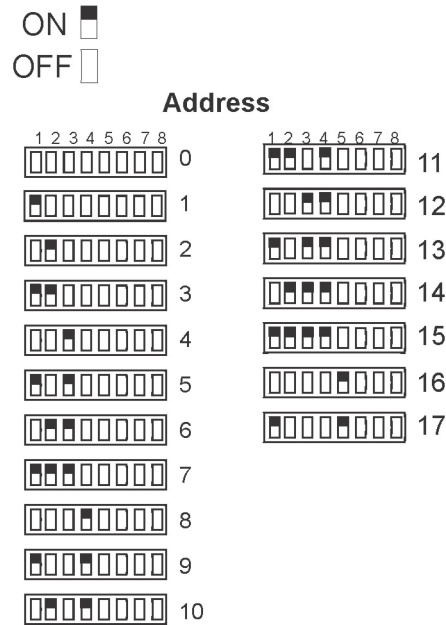

Figure 5.11 Network ID Settings

Section 6: Network Management

6.1 Network Diagnostics

6.1.1 Ping Panel

The Ping Panel menu allows you to continually ping any panel programmed into the network. As the selected panel is being pinged, the Ping Panel screen will display the reply time, minimum and maximum reply times, and sent and received counters.

1. Enter the Installer Code. The panel will automatically go to the main menu.
2. Select 5 for Network Diagnostics.
3. Press 1 to enter the Ping Panel Menu.
4. Press the up or down arrow key to select Network Panel ID. Press ENTER to Ping panel.

6.1.2 Data Network Status

The Data Network Status screen will display statistics that are indicators of Network performance.

1. Enter the Installer Code. The panel will automatically go to the main menu.
2. Select 5 for Network Diagnostics.
3. Press 2 to enter the Data Network Status menu.

6.1.3 Voice Network Status

The Voice Network Status screen will display statistics that are indicators of Network performance.

1. Enter the Installer Code. The panel will automatically go to the main menu.
2. Select 5 for Network Diagnostics.
3. Press 3 to enter the Voice Network Status menu.

6.2 Network Programming

This section of the manual describes how to program network options using the built-in annunciator. All options described in this section can be programmed using the HFSS Honeywell Fire Software Suite. To edit site assignments, HFSS must be utilized.

6.2.1 Learn Network

The Learn Network menu shows you all of the panels connected to the network. Any panel that has been programmed into the network will appear as a “member.” Any panel that is connected to the network but not programmed into the network will appear as a “guest.” You can add guest panels to the network by changing their status to member in this menu. Panels showing OK are currently responding on the network. Panels not showing OK have either been removed or are not responding due to networking problems. See Section Figure 6.1 for Network Diagnostics.

1. Enter the Installer Code. The panel will automatically go to the main menu.
2. Select 6 for Network Programming.
3. Press 1 to enter the Learn Network menu.
4. Press ENTER to add or remove panels connected to the network as member or guest.



NOTE: If adding panels to network, the system will automatically run the Sync Network Options. You will be required to select which panel to distribute network options from. See Section 6.4.

6.2.2 Edit Network Names

The Edit Network menu allows you to edit the panel name and edit the panels site name.

■ To Edit Panel Names:

1. Enter the Installer Code. The panel will automatically go to the main menu.
2. Select 6 for Network Programming.
3. Press 2 to enter the Edit Network Names menu.
4. Press 1 to Edit Panel Name. Choose Panel to edit.

See “Editing Text Using the Built-In Programmer” on page 214 for a list of available characters and their numeric designators.

6.2.3 Edit Panel ID

This menu option allows you to change the current Network Panel ID. It is best to carefully consider the network ID setting for each panel. Take into account any future panels that will be added to the network (future wiring of two buildings together). The Network Panel ID setting has to be unique for each panel on the network.

This menu will allow you to change the currently assigned Network Panel ID to the current Network ID dip switch setting. The system will be down as the panel needs to reboot in order to complete the transition.

When using the PC configuration software to program the panels, the Network Panel ID will be locked from future editing. The only way to change it will be to restore defaults and use this menu again.

■ To Edit the Network Panel ID:

1. Enter the installer code. The panel will automatically go to the main menu.
2. Select 6 for Network Programming.
3. Press 3 to enter the Edit Panel ID menu.
4. If the Network Panel ID is changed and valid, the system will ask you to confirm the change. If it is not correct, you can change the dip switches at this time.
5. Press up to select YES and press ENTER to confirm.

6.2.4 Computer Access

An installer at the panel site can initiate communications between the panel and a computer running the HFSS Honeywell Fire Software Suite (see also Section 10.5). In order for this communication to function properly, both the computer (running the software) and the control panel must have matching computer access numbers and computer codes.

To program computer access information:

1. Enter the installer code. The panel will automatically go to the main menu.
2. Select 6 for Network Programming.
3. Press 4 to enter the Computer Access menu.
4. Enter the computer access number (up to 6-digits), then press ENTER.
5. Enter the computer code, then press ENTER.

6.2.5 Access Codes

Access codes provide the user access to the control panel functions. Each access code can be customized for each user. This allows some users the ability to access programming and other higher level panel functions, while other users may only need access to lower level functions such as performing fire drills, or acknowledging trouble conditions.

Profile 1 is the profile that dictates what functions the Fire Fighter Key has access to. Because this is the profile for a key, the user name and the access code can not be edited for this profile.

Profile 2 is the profile for the installer and is referred to as the “Installer Code”. This profile’s user name and panel functions can not be edited. Table 7-9 lists the panel functions that can be selected for each user profile.

Type of Function	Selectable Functions
Panel Operations	System Reset
	System Silence
	System Ack
	Fire Drill Key
	Multi-site
	F1 Function Key
	F2 Function Key
	F3 Function Key
	F4 Function Key
	ECS Control Request Function
	ECS Super User Function
Panel Menus	System Tests
	Fire Drill Menu
	Indicator Test
	Walk Test-No Report
	Walk Test -With Report
	Communicator Test
	Clear History Buffer
	Point Functions
	Disable/Enable Point
	Point Status
	Set SLC Device Address
	SLC Single Device Locator
	SLC Multiple Device Locator
	I/O Point Control
	Event History

Table 6.1 User Profile Selectable Panel Functions

Type of Function	Selectable Functions
Panel Menu	Set Time & Date
	System Information
	Network Diagnostics
	Network Programming
	Panel Programming
	Send/Receive Firmware Update

Table 6.1 User Profile Selectable Panel Functions

To change an access code:

1. Enter the installer code. The panel will automatically go to the main menu.
2. Select 6 for Network Programming Menu.
3. Select 5 for Access Codes.

Display reads: *Select Profile 01*
Fire Fighter's Key

4. Select the access code you wish to edit by pressing the up or down arrow key.
5. Then press ENTER.

■ Profile Edit Menu

From the Profile Edit Menu you can change the users name, access code, and the panel functions that the user will have access to with their code.



NOTE: Profile 1 (Fire Fighter's Key) the user name and access code can not be edited. Profile 2 (Installer) the user name and panel functions can not be edited. Profile 3 (Multi-Site Installer) is defaulted with the Multi-Site access option, but the entire profile can be edited.

Edit Name

6. See Appendix B for a list of available characters and their numeric designators.
7. Then press ENTER to finish.

Edit Access Code

8. Enter new access code (minimum of 4 digits, maximum of 7 digit).
9. Press ENTER.
10. Enter code again. Press ENTER.

Panel Functions

11. Press the up or down arrow key to move through the list of available functions.
12. Then press right arrow to move to Y (yes) or N (no) selection column.
13. Press the up or down arrow key to select Y or N.
14. Press ENTER.
15. Repeat steps 12 through 15 until user profile is complete.

6.2.6 Communicator Options

Communicator options provides the configuration for reporting events to a central station.

1. From the main menu.
2. Select 6 for Network Programming.
3. Press 6 to enter Communicator Options menu.

Communicator Assignments

Each panel on the IFP-2100/ECS network specifies which network communicator is used for reporting. The network communicator capability of the IFP-2100/ECS system allows all panels to use the same communicator providing an economical solution for reducing the number of paths required for reporting purposes. A communicator is specified by panel number. The network communicators will be used to report events according to the communicator report table.

Communicator Miscellaneous

When using the SIA reporting format, the communicator sends information according to the SIA Reporting Type. The selections for this option are:

1. pi modifier (default)
2. Panel ID

Receiver Configuration

The IFP-2100/ECS network can report events to as many as 68 receivers. See Appendix D for panel/receiver relationship numbers. Each receiver can be assigned reporting credentials. When using a format that supports phone numbers, it can be up to forty digits long.

1. From the main menu.
2. Select 6 for Network Programming.
3. Press 6 to enter Communicator Options menu.
4. Select 3 for Receiver Configuration.
5. Select Panel to Program and press ENTER.
6. Enter the receiver number that you want to report to. The receiver numbers available will correspond with what panel number you entered. Receiver numbers are populated based on panel number and audited to allow only the 4 appropriate receivers. See Appendix D for receiver number.

Available Format choices are:

Reporting Format
Contact ID
SIA500
SIA8
SIA20
Ethernet
Cellular
eVance
UNUSED

Communicator Reporting Table

The Communicator Report Table specifies event reporting for each panel on the network. Each row in the table specifies a panel, event types to report, primary and backup receiver numbers, and report by point or zone. Associated with the receivers are account number and daily test option. The table can have up to 99 rows.

1. From the main menu.
2. Select 6 for Network Programming.
3. Press 6 to enter Communicator Options menu.
4. Select 4 for Communicator Reporting Table.
5. Press * to add rows, Press ENTER to edit data

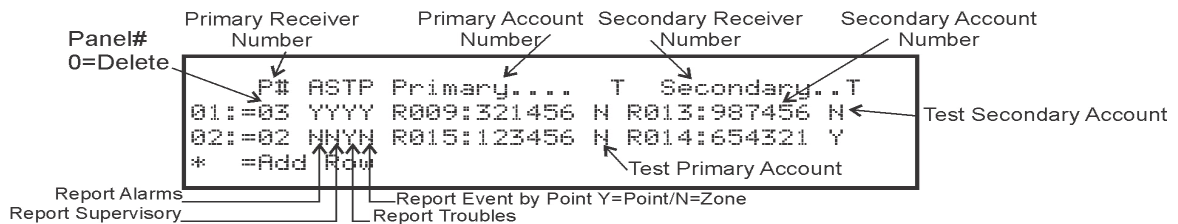

Figure 6.1 Communicator Reporting

6.3 Voice Options

6.3.1 Edit Timers

1. Enter the installer code. The panel will automatically go to the main menu.
2. Select 6 for Network Programming.
3. Select 7 for Voice Options.
4. Choose Site.
5. Select 1 for Edit Timers

Control Lockout

The Control Lockout countdown timer is set to the programmed value when an LOC gains ECS Control. The timer starts over upon any key press at the ECS Control LOC. While the Control Lockout timer is active, an LOC of equal priority must request ECS control. The Control Lockout timer is cleared when ECS Control is relinquished. The Control Lockout timer does not apply to ECS Super User control.

Select Immediate/Timer/Never

Range 0-720 min/0-59 sec

Auto Reset ECS MIC Triggered Event

If the Timer is selected, the event will automatically reset after being active for the programmed time. If Event Disabled is selected, the event will not be allowed to be activate from an LOC Station. Selecting Never will require an emergency system reset to be performed to reset the event.

Select Never/Timer/Event Disabled, Range from 1-240 min

ECS Timer	Option
Control Lockout	Immediate/Timer/Never
Auto Reset ECS MIC Triggered Event	Never/Timer/Event Disabled
Auto Reset ECS Event 1	Never/Timer/Event Disabled
Auto Reset ECS Event 2	Never/Timer/Event Disabled
Auto Reset ECS Event 3	Never/Timer/Event Disabled
Auto Reset ECS Event 4	Never/Timer/Event Disabled
Auto Reset ECS Event 5	Never/Timer/Event Disabled
Auto Reset ECS Event 6	Never/Timer/Event Disabled
Auto Reset ECS Event 7	Never/Timer/Event Disabled
Auto Reset ECS Event 8	Never/Timer/Event Disabled

Table 6.2 Auto Reset ECS MIC Triggered Event Timer Menu

6.3.2 Edit Voice Commands

When a voice output group is selected to be activated by a zone, the cadence pattern choice does not apply. For voice output groups, one of six system wide voice commands will activate instead of the cadence pattern.

1. Enter the installer code. The panel will automatically go to the main menu.
2. Select 6 for Network Programming Menu.
3. Select 7 for Voice Options.
4. Choose Site.
5. Select 2 for Edit Voice Commands.
6. Select the command you wish to edit:

System Event
Fire Alarm
Fire System Aux 1
Fire System Aux 2
Fire Zone Aux 1
Fire Zone Aux 2
Fire Pre Alarm
Emergency Communication 1
Emergency Communication 2
Emergency Communication 3
Emergency Communication 4
Emergency Communication 5
Emergency Communication 6
Emergency Communication 7
Emergency Communication 8
Fire Supervisory
System Alert 1-5
Trouble
Fire Interlock Release
Fire Interlock Alert
Custom Emergency Comm
Emergency Supervisory
CO Alarm
CO Supervisory

Table 6.3 Voice Command Mapping

7. Select whether a Message or Tone Only should be played. If Message is selected, choose the desired message for the command.
8. Select the tone to be played between messages. (High-Lo, ANSI Whoop, Cont. Whoop, ANSI, March Code, California, Steady, Alert Tone, or No Tones).



NOTE: 520Hz tones are available when using ECS-VCM, ECS-NVCM, ECS-INT50W or ECS-Dual50W AMP's. These include ANSI 520, Temp 4 520, Steady 520. See Table A.6 for a list of compatible speakers.

9. Select how many times you wish the message to repeat. (None, 1 - 14, or Continuous).
10. Select the initial delay time (0, 3, 4, 8, 12, 16, 20, 24, 28).
11. Select the inter message delay time (4 to 32 seconds, in 4 second increments).
12. Select Y or N to allow message to continue to play after Mic release.
13. Select Y or N to allow message to restart on a new activation.

6.4 Sync Network Options

If after making changes to network programming, the distribution of network options fail, the system will report a trouble of network options out of sync. Use this menu to redistribute changed options to the rest of the network. The user will be required to choose a panel to source the options from. Scroll down through the informational message and press ENTER to view the Select Source screen.

1. Enter the installer code. The panel will automatically go to the main menu.
2. Select 6 for Network Programming Menu.
3. Select 8 for Sync Network Options.
4. Select which panel to source the options from.

Last time the date & time were updated on panel.

If 2 panels have the same chk sum, network options are in sync.

Select Source	Last Modified	Chk sum
01 = Panel 1	04/12/13 12:20	0F8B
02 = Panel 2	04/15/13 09:45	0F8A
03 = Panel 3	04/15/13 09:46	0F8A

6.5 Network Management Quick Reference

	Menu	Options/Defaults			Comments	
Network Programing	Learn Network	Guest or member	Add or remove panels into the network		See Section 6.2.1	
	Edit Network Names	Panel Names	Network Panel ID	Edit Panel Names	See Section 6.2.2	
		Site Names	Edit Site Member	Edit Site Names		
	Edit Panel ID	Change current panel ID			See Section 6.2.3	
	Computer Access	Computer Access Number	*123456		See Section 6.2.4	
		Computer Code	*0			
	Access Codes	Select Profile (01 - 20)		Edit Name		<p>Profile 1 is the profile that dictates what functions the Firefighter Key has access to. Because this is the profile for a keys, the user name and the access code can not be edited for this profile.</p> <p>Profile 2 is the profile for the installer and is referred to as the "Installer Code". This profile's user name and panel functions can not be edited. See Section 6.2.5.</p>
				Edit Access Code		
				Panel Functions	System Reset	
					System Silence	
					System ACK	
					Fire Drill Key	
					System Tests	
					Fire Drill Menu	
					Indicator Test	
					Walk Test-No Report	
					Walk Test-With Report	
Communicator Test						
Clear History Buffer						
Point Functions						
Disable/Enable Buffer						
Point Status						
Set SLC Device Address						
SLC Single Device Locator						
SLC Multi-Device Locator						
I/O Point Control						
Event History						
Set Time & Date						
Network Diagnostics						

	Menu	Options/Defaults			Comments			
Network Programming (cont.)	Access Codes	Select Profile (01 - 20)	Panel Functions	Network Programming	Profile 1 is the profile that dictates what functions the Firefighter Key has access to. Because this is the profile for a keys, the user name and the access code can not be edited for this profile. Profile 2 is the profile for the installer and is referred to as the "Installer Code". This profile's user name and panel functions can not be edited. See Section 6.2.5			
				Panel Programming				
				System Information				
				Multi-Site				
				Upload/Download				
				F1 Function Key				
				F2 Function Key				
				F3 Function Key				
				F4 Function Key				
				ECS Control Request Function				
				ECS Super User Function				
	Communicator Options	Communicator Assignments	Select Panel	Primary	0=unused	See Section 6.2.6		
		Communicator Miscellaneous	SIA Options	Enable pi SIA Modifier		See Section Communicator Miscellaneous		
				Include Panel ID in SIA Reporting				
		Receiver Configuration	Receiver Format	Select Panel	Select Receiver	Receiver Number	See Section Receiver Configuration	
				Contact ID				
				SIA500				
				SIA8				
				SIA20				
				eVance				
Ethernet								
Cellular								
UNUSED								
Receiver Credentials								
Communicator Report Table				Panel	See Section Communicator Reporting Table			
				Report Alarms				
				Report Supervisory				
				Report Troubles				
				Report Events by Point				
				Primary Receiver				
				Primary Account				
				Test Primary Account				
				Secondary Receiver				
				Secondary Account				
Test Secondary Account								

	Menu	Options/Defaults			Comments	
Network Programming (cont.)	Voice Options	Choose Site	Edit Timers	Control Lockout	Immediate/Timer/Never	See Section 6.3.1
				Auto Reset ECS Event 1-8	Never/Timer/Event Disabled	
				Auto Reset ECS MIC Triggered Event		
			Edit Voice Commands	Fire Alarm	See Section 6.3.2	
				Fire System Aux 1		
				Fire System Aux 2		
		Fire Zone Aux 1				
		Fire Zone Aux 2				
		Fire Supervisory				
		Fire Pre Alarm				
		Custom Emergency Comm				
		Emergency Communication 1-8				
		System Alert 1-5				
	Trouble					
Fire Interlock Release						
Choose Site	Edit Voice Commands	Fire Interlock Alert	See Section 6.3.2			
		Emergency Supervisory				
		CO Alarm				
		CO Supervisory				
Sync Network Options				See Section 6.4		

Section 7: IDP, SK, SD and SWIFT™ SLC Device Installation



CAUTION: TO AVOID THE RISK OF ELECTRICAL SHOCK AND DAMAGE TO THE UNIT, POWER SHOULD BE OFF AT THE CONTROL PANEL WHILE INSTALLING OR SERVICING.

7.1 List of IDP SLC Devices

Table 7.1 list available IDP SLC devices can be used with the control panel. See the device installation instructions (packaged with the device) for more information.



NOTE: The control panel supports the use of either IDP, SK, or SD SLC devices. You cannot install a mix of SLC device types on the control panel. IDP SLC devices can be used with IDP wireless devices.

Part Numbers	Model Name/Description	Install Sheet PN
IDP-PHOTO	Photoelectric smoke detector	156-3611-000
IDP-PHOTO-T	Photoelectric smoke detector with thermal (135°F)	
IDP-ACCLIMATE	Multi-criteria photoelectric smoke detector with thermal (135°F)	
IDP-PHOTOR	Photoelectric replacement smoke detector with remote test capability in DNR	156-3569-000
IDP-BEAM	Reflected beam smoke detector without test feature	156-2735-00
IDP-BEAM-T	Reflected beam smoke detector with test feature	
DNR/DNRW	Duct smoke detector housing. Non-relay (photo sold separately)	156-3051-000
IDP-HEAT	Fixed temperature thermal detector (135°F)	156-3608-000
IDP-HEAT-ROR	Rate-of-rise thermal detector with 135° fixed temperature	
IDP-HEAT-HT	Fixed high temperature thermal detector (190°F)	
IDP-PULL-SA	Addressable single action pull station	156-3606-000
IDP-PULL-DA	Addressable dual action pull station	156-3605-000
IDP-ISO	Fault isolator module	156-2729-000
ISO-6	Six Fault isolator module	156-4096-000
IDP-MONITOR	Monitor module	156-3603-000
IDP-MINIMON	Mini monitor module	156-2726-002
IDP-MONITOR-2	Dual input monitor module	156-2730-000
IDP-MONITOR-10	10 input monitor module	156-2731-000
IDP-RELAY	Relay module	156-2729-000
IDP-RELAY-6	Six circuit relay module	156-2729-000
IDP-RELAYMON-2	Multi module with 2 relay outputs & 2 monitor inputs	156-3734-000
IDP-ZONE	Zone interface module	156-3602-000
IDP-ZONE-6	Six zone interface module	156-2733-000
IDP-CONTROL	Supervised control module	156-3600-000
IDP-CONTROL-6	Six circuit supervised control module	156-2734-000
IDP-FIRE-CO	CO Smoke Detector	156-3946-00
B200S-WH / IV	Intelligent Sounder base.	156-3387-00
B200SR-WH / IV	Intelligent Sounder base	156-3392-00
B210LP	6" Plug-in Detector base	156-3739-00 / 156-0595-00
B300-6, -IV	6" Plug-in Detector Base	156-6566-00
B224BI-WH / IV	6" isolator base	156-0725-00
B224RB-WH / IV	6" relay base	156-3737-00
B200SR-LF-WH / IV	Low Frequency Sounder Base	156-4152-00
B200S-LF-WH / IV	Low Frequency Sounder Base	156-4151-00
B501	4" Plug-in Detector Base	156-0357-00
B200S-WH / IV	Intelligent Sounder base.	156-3387-00
IDP-PHOTO-W/IV	Photoelectric smoke detector. White or Ivory	156-6531-00
IDP-PHOTO-W / IV	Photoelectric smoke detector	156-6531-00
IDP-PHOTO-R-W / IV	Photoelectric replacement smoke detector with remote test capability in DNR	156-6532-00
IDP-PHOTO-T-W / IV	Photoelectric smoke detector with thermal (135°F)	156-6534-00

Table 7.1 IDP SLC Devices

Part Numbers	Model Name/Description	Install Sheet PN
IDP-HEAT-W / IV	Fixed temperature thermal detector (135°F)	156-6533-00
IDP-HEAT-ROR-W / IV	Rate-of-rise thermal detector with 135° fixed temperature	156-6533-00
IDP-HEAT-HT-W / IV	Fixed high temperature thermal detector (190°F)	156-6533-00

Table 7.1 IDP SLC Devices

7.2 List of SK SLC Devices

Table 7.2 list available SK SLC devices can be used with the control panel. See the device installation instructions (packaged with the device) for more information.

The control panel supports the use of either IDP, SK, or SD SLC devices. You cannot install a mix of SLC device types on the control panel. SK SLC devices can be used with SK wireless devices.

Part Numbers	Model Name/Description	Install Sheet PN
SK-PHOTO	Photoelectric smoke detector	156-3426-001
SK-PHOTO-T	Photoelectric smoke detector with thermal (135°F)	
SK-PHOTOR	Photoelectric detector with remote test capability	
SK-ACCLIMATE	Multi-criteria photoelectric smoke detector with thermal (135°F)	
SK-BEAM	Reflected beam smoke detector without test feature	156-3433-001
SK-BEAM-T	Reflected beam smoke detector with test feature	
SK-DUCT	Photoelectric duct smoke detector with extended air speed range	156-3432-000
SK-HEAT	Fixed temperature thermal detector (135°F)	156-3429-000
SK-HEAT-ROR	Rate-of-rise thermal detector with 135° fixed temperature	
SK-HEAT-HT	Fixed high temperature thermal detector (190°F)	
SK-PULL-SA	Addressable single action pull station	156-3446-000
SK-PULL-DA	Addressable dual action pull station	156-3447-000
SK-ISO	Fault isolator module	156-3445-000
SK-MONITOR	Monitor module	156-3442-000
SK-MINIMON	Mini monitor module	156-3444-000
SK-MONITOR-2	Dual input monitor module	156-3435-000
SK-MON-10	10 input monitor module	156-3443-000
SK-RELAY	Addressable relay module	156-3438-000
SK-RELAY-6	Six relay control module	156-3439-000
SK-RELAYMON-2	Dual relay/monitor module	156-3735-000
SK-ZONE	Addressable zone interface module	156-3440-000
SK-ZONE-6	Six zone interface module	156-3441-000
SK-CONTROL	Supervised control module	156-3436-000
SK-CONTROL-6	Six circuit supervised control module	156-3437-000
SK-FIRE-CO	CO Smoke Detector	156-3945-000
B200S-WH / IV	Intelligent sounder base.	156-4151-00
B200SR-WH / IV	Intelligent sounder base	156-4152-00
B210LP	6" Plug-in Detector base	156-3739-00 / 156-0595-00
B300-6, -IV	6" Plug-in Detector Base	156-6566-00
B224BI-WH / IV	6" isolator base	156-0725-00
B224RB-WH / IV	6" relay base	156-3737-00
B200SR-LF-WH / IV	Low Frequency Sounder Base	156-0357-00
B200S-LF-WH / IV	Low Frequency Sounder Base	156-4152-00
B501	4" Plug-in Detector Base	156-0357-00
B501-WHITE / IV / BL	4" Plug-in Detector Base	156-3738-00
SK-PHOTO-W	Photoelectric smoke detector	156-6527-00
SK-PHOTO-R-W	Photoelectric detector with remote test capability, for use with DNR duct smoke detector	156-6528-00
SK-PHOTO-T-W	Photoelectric smoke detector with thermal (135°F)	156-6530-00
SK-HEAT-W	Fixed temperature thermal detector (135°F)	156-6529-00

Table 7.2 SK SLC Devices

Part Numbers	Model Name/Description	Install Sheet PN
SK-HEAT-ROR-W	Rate-of-rise thermal detector with 135° fixed temperature	I56-6529-00
SK-HEAT-HT-W	Fixed high temperature thermal detector (190°F)	I56-6529-00
Color Guide: -IV = Ivory color, -BL = Black, -WH = White, -WHITE=White		

Table 7.2 SK SLC Devices

7.3 List of SD SLC Devices

Table 7.3 list available SD SLC devices that can be used with the control panel. See the appropriate section number in this manual or the device installation instructions (packaged with the device) for more information.

Part Numbers	MODEL NAME/DESCRIPTION	Install Sheet PN
SD505-PHOTO	Photoelectric smoke detector.	150955
SD505-HEAT	Absolute temperature heat detector. Trip point range from 135°F–150°F (0°C–37°C).	
SD505-6AB	6" base	
SD505-6IB	6" short circuit isolator base	I56-3541-00
SD505-6RB	6" relay base	I56-3542-00
SD505-6SB	6" sounder base	I56-3540-00
SD505-DUCT	Duct Smoke Detector. Duct Housing including the SD505- Analog Photoelectric Smoke Sensor. Intake tubing for duct available in three lengths: SD505-T2 (2.5 foot); SD505-T5 (5 foot); SD505-T10 (10 foot)	1700-09882
SD505-DUCTR	Duct Detector housing with relay base. Duct housing with relay base including SD505- Analog Photoelectric Smoke detector pre-installed	1700-09882
SD500-PS/-PSDA	Single or dual action addressable pull station	I56-3632-00
SD500-AIM	Addressable input module (switch input), standard size, DIP switch configurable	I56-3547-00
SD500-MIM	Mini input monitor module (switch input), small size, DIP switch configurable.	
SD500-ANM	Addressable notification module	I56-3544-00
SD500-ARM	Addressable relay module DIP switch configurable.	I56-3545-00
SD500-SDM	Addressable smoke detector module.	I56-3546-00
SD500-LIM	Line isolator module. Fits in a double gang box.	I56-3543-00
SD505-DTS-K	Remote test switch & LED indicator for the SD505-DUCTR	1700-09882

Table 7.3 SD SLC Devices

7.4 SWIFT Wireless SLC Devices

The WIDP-WGI Wireless Gateway acts as a bridge between a group of wireless fire devices and a SLC loop on the IFP-2100/ECS. It is powered by the SLC loop or by a regulated, external 24VDC UL-listed power supply. Available wireless devices include a photo detector, a photo/heat detector, a fixed-temperature heat detector, a rate-of-rise detector, and a monitor module. For updated details about wireless devices, system setup and operation see the SWIFT® Smart Wireless Integrated Fire Technology Manual # LS10036-00FH-E or LS10036-00SK-E for more information.

7.5 Maximum Number of SLC Devices

The IFP-2100/ECS supports IDP, SK,SD, or Wireless SLC devices. The maximum number of SLC devices per panel is 2100 for IDP or SK devices, or 2032 if using SD devices. The number of SLC expanders is limited only by the SBUS bandwidth, point count, and 1A SBUS current limit. Device support is as follows:

- IDP or SK Devices - The IFP-2100/ECS supports a total of 2100 IDP or SK points. The SLC points can be all sensors or all modules or any combination of modules and sensors.
- or
- SD Devices - The IFP-2100/ECS system can support a total of 2032 SD devices, in any combination. SD devices are only supported on the 5815XL.
- or
- IDP SWIFT Wireless Devices—A SWIFT Gateway system supports up to 50 devices: 1 SWIFT Gateway and up to 49 (in any combination) wireless detectors and monitor modules. Multiple Gateways can be used. See the SWIFT manual P/N LS10036-00FH-E for more information.

7.6 Wiring Requirements for SLC Devices

The following information applies to SLC devices. Refer to the section that describes the type of device you are installing for details.

7.6.1 Wire Sizing on 5815XL for SD Devices

The wire can be untwisted, unshielded, solid or stranded as long as it meets the National Electric Code 760-51 requirements for power limited fire protective signaling cables. Wire distances are computed using copper wire.

Maximum wiring resistance is 50 ohms for SD devices.

Maximum loop length depends on the wire gauge. See Table 7.4 for SD.

Wire Gauge	Max. Distance for SD
22 AWG	1500 feet
18 AWG	3900 feet
16 AWG	6200 feet
14 AWG	10,000 feet

Table 7.4 Maximum wiring distance for SD device

7.6.2 Wire Sizing for 6815

The SLC requires use of a specific wire type, depending on mode of operation, to ensure proper circuit functioning. Wire size should be no smaller than 18 AWG (.075 mm) and no longer than 12 AWG (3.25 mm) wire. The wire size depends on the length of the SLC circuit. It is recommended that all wiring be twisted-pair to minimize the effects of electrical interference shield termination

7.6.3 Wiring Requirements for IDP or SK Modules

The IFP-2000/ECS SLC can be programmed to operate in IDP/SK mode. While shielded wire is not required, it is recommended that all SLC wiring be twisted-pair to minimize the effects of electrical interference. Use Table 7.5 to determine the specific wiring requirements for the SLC.

Wire Requirements	Distance in Feet (meters)	Wire Type
RECOMMENDED: Twisted-unshielded pair, 12 to 18 AWG (3.31mm ² to 0.82 mm ²). 50 ohms, maximum per length of Style 6 & 7. 50 ohms per branch maximum for Style 4 loop.	12,500 ft. (3,810 m) 9,500 ft. (2895.6 m) 6,000 ft. (1,828.8 m) 3,700 ft. (1,127.76 m)	12 AWG (3.31 mm ²) 14 AWG (2.08 mm ²) 16 AWG (1.31 mm ²) 18 AWG (0.82 mm ²)
Untwisted, unshielded wire, in conduit or outside of conduit.	5,000 ft. (1,528 m) 3,700 ft. (1,127.76 m)	12 to 16 AWG (3.31 ² mm to 1.31 mm ²) 18 AWG (0.82 mm)
Twisted, shielded pair Note: • Shields must be isolated from ground • Shields should be broken at each device	5,000 ft. (1524 m) 3,700 ft. (1,127.76 m)	12 to 16 AWG (3.31 mm ² to 1.31 mm ²) 18 AWG (0.82 mm ²)
RECOMMENDED: Twisted-unshielded pair, 12 to 18 AWG (3.31mm ² to 0.82 mm ²). 50 ohms, maximum per length of Style 6 & 7. 50 ohms per branch maximum for Style 4 loop.	12,500 ft. (3,810 m) 9,500 ft. (2895.6 m) 6,000 ft. (1,828.8 m) 3,700 ft. (1,127.76 m)	12 AWG (3.31 mm ²) 14 AWG (2.08 mm ²) 16 AWG (1.31 mm ²) 18 AWG (0.82 mm ²)

Table 7.5 SLC Wiring Requirements for IDP or SK modules

Figure 7.1 and Figure 7.2 show how wire length is determined for out & back tap and T-Tap.

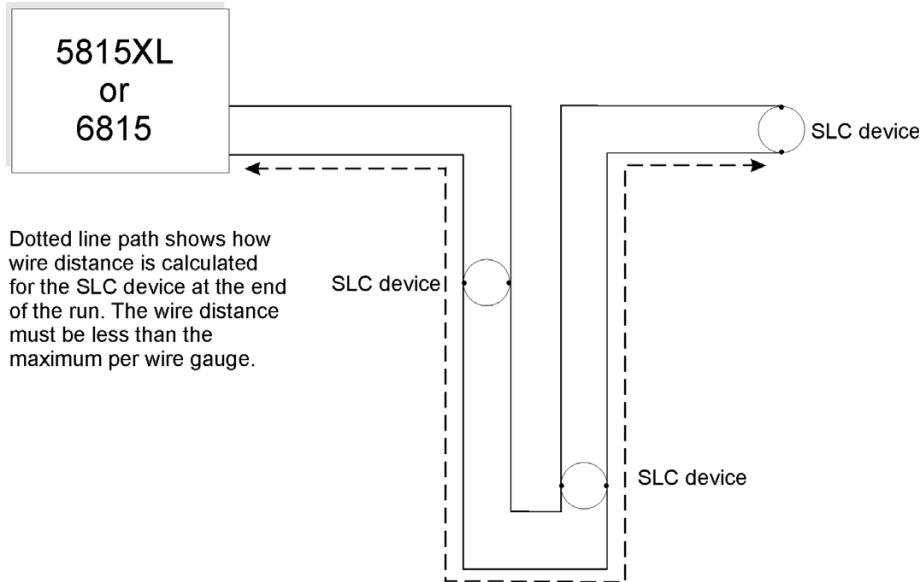

Figure 7.1 Calculating wire run length for a simple out and back

When using T-taps, the total length of all taps and the main bus must not exceed 40,000 feet. This requirement must be met in addition to the maximum distance requirements for the various wire gauges.

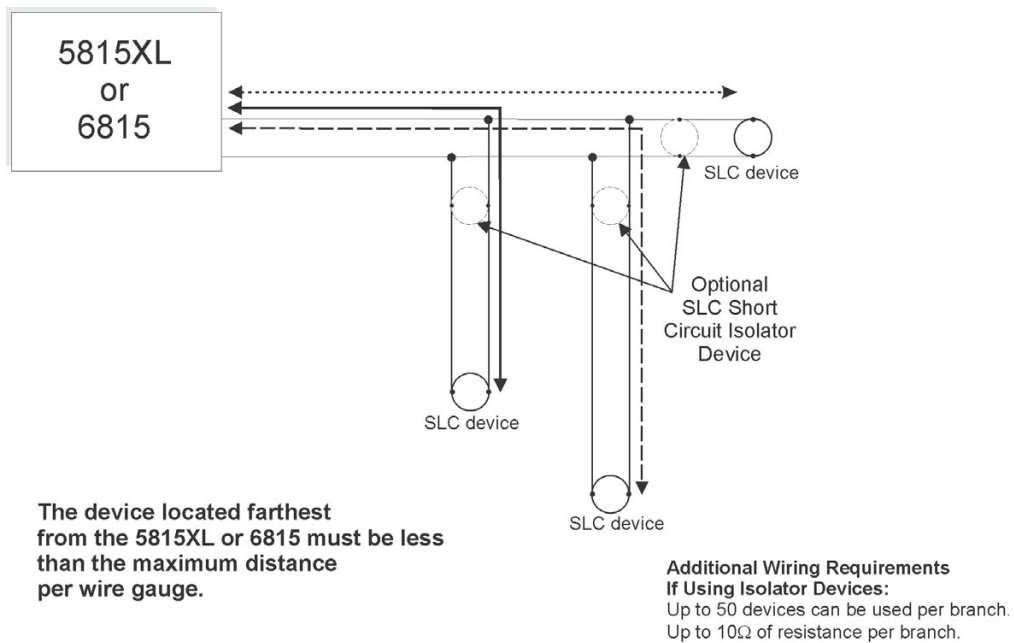

Figure 7.2 Calculating Wire Run Length for a T-tap

7.6.4 Wiring 5815XL or 6815 in Style 6 & 7 (Class A) Configuration

Figure illustrates how to wire the SLC loop for Class A installations.



NOTE: Style 6 does not use short circuit isolator devices

NOTE: Style 7 requires an isolator module as the first device on the in and the out loop

NOTE: No t-taps allowed on class A SLC loops

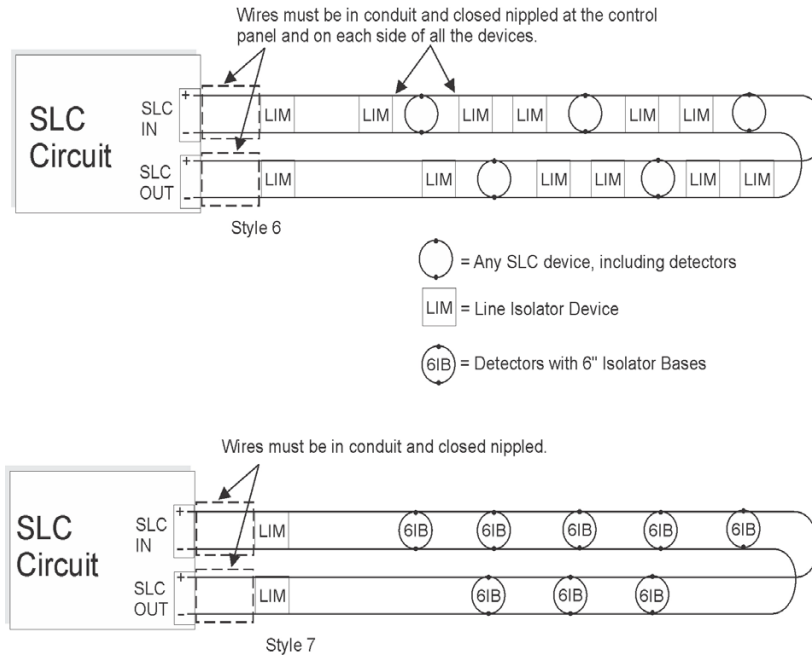

Figure 7.3 Class A SLC Configuration

7.7 Addressing IDP or SK SLC Devices

All IDP or SK devices are addressed using the two rotary dials that appear on the device board. Use the *ONES* rotary dial to set the ones place in a one or two digit number, and use the *TENS* rotary dial to set the tens place in a two or three digit number.

The control panel recognizes when an IDP/SK detector or IDP/SK module is installed. For this reason, IDP/SK detectors can be assigned any unique address from 1 to 159, and IDP/SK modules can be assigned any unique address from 1 to 159. There can be an IDP/SK detector using address 1 and an IDP/SK module using address 1.

0 is an invalid address. In order to set the sensor above address 99, carefully remove the stop on the upper rotary switch with thumb as shown in Example 2.

Example 1: To select device address 35, turn the *ONES* rotary dial to **5** and the *TENS* rotary dial to **3** as shown in Figure 7.4.

Example 2: To select device address 105, turn the *ONES* rotary dial to **5** and the *TENS* rotary dial to **10** as show in Figure 7.4.

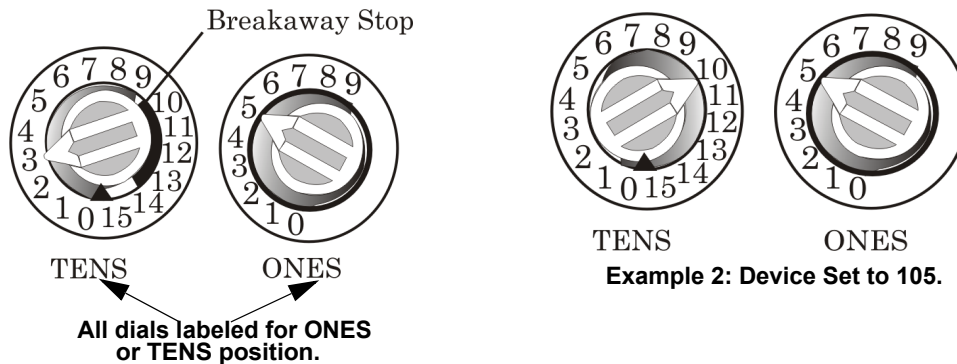

Figure 7.4 IDP or SK SLC Device Addressing Using Rotary Dials

7.8 Wiring SD Detectors

The information in this section applies to SD Detectors. See Table 7.3 for P/N's.

To Wire SD Detectors

1. Wire device bases as shown in Figure 7.5.

- Set the address for each device as described in Section 7.9.

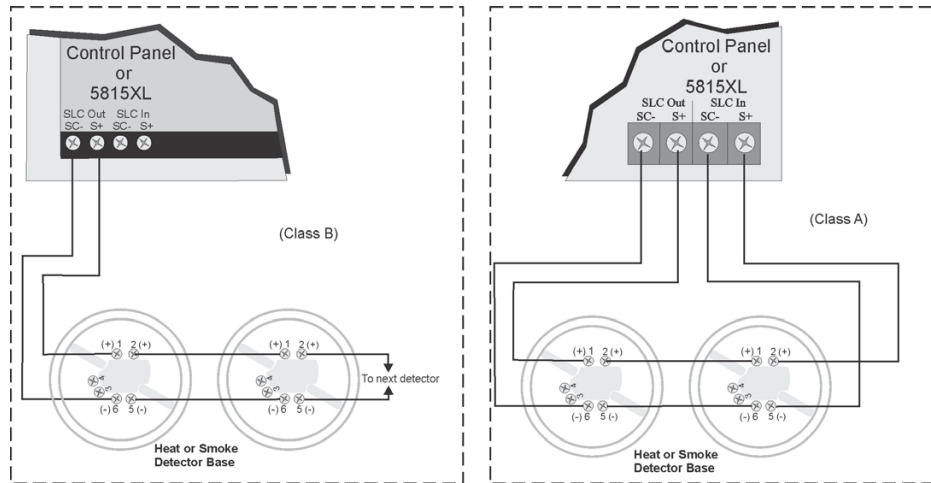

Figure 7.5 Heat or Smoke Detector Connection to the FACP

7.9 Addressing SD Devices

This section explains how to address SD detectors and modules. See Table 7.3 for a list of SD devices.

An access code with the option to set SLC Device Address enabled is required to perform this task.

To address a SD detectors:

- Connect a detector base temporarily to the programming terminals as shown in Figure 7.6. (You can use the same base for each detector.

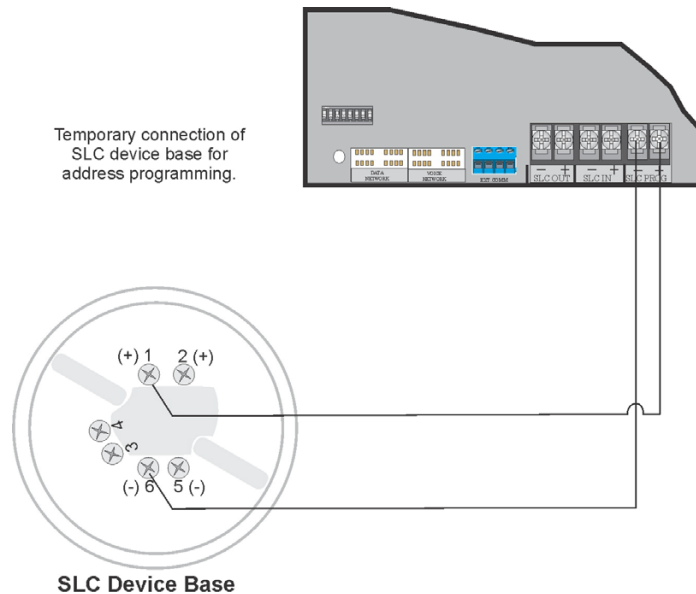

Figure 7.6 Temporary Connection of Detector Base to Panel for Addressing

- Enter the Installer Code. The panel will automatically go to the main menu.
- Select 2 for Point Functions.
- Select 3 for Set SLC Dev Addr.
- Select “Yes” by pressing the up arrow, then press ENTER. (The panel will go into trouble at this point. You can use the SILENCE key to stop the PZT. The trouble will clear automatically when the panel re-initializes when you finish programming.)
- When the wait message clears, the following options display:
 - for Read Address. Use to read (or check) a single detector’s address.
 - for Write Address. Use to program a single detector’s address.
 - for Seq. Programming. Use to program more than one detector in sequential order.
- If you are changing addresses, write the programmed address on the back of the device.
- To exit press left arrow until fully exited.

7.9.1 SLC Devices with DIP Switches

Input and relay module addresses are set using the DIP switches on the module board. The chart below shows the available addresses. For example, to select address 3, place DIP switches 1 and 2 in the up position. The range of valid addresses is 1-127. 0 is an invalid address.

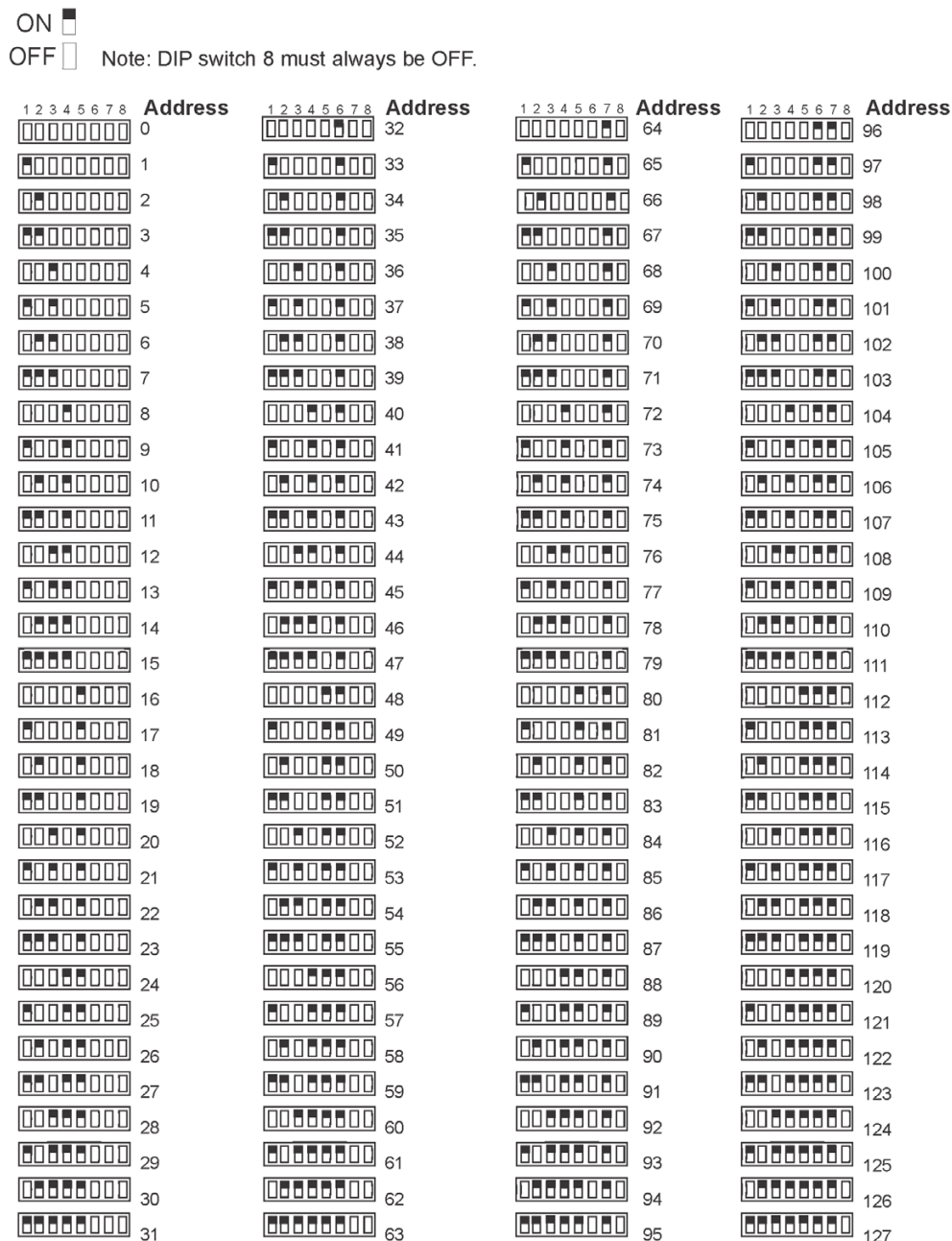

Figure 7.7 Device Addressing using DIP Switches

7.10 Wiring the WIDP-WGI or SK-WGI



NOTE: The WIDP-WGI or SK-WGI, as part of the wireless network, has been tested for compliance with the Federal Communications Commission (FCC) requirements of the United States Government. It has not been evaluated for use outside the USA. Use of this system outside the USA is subject to local laws and rules to which this product may not conform. It is the sole responsibility of the user to determine if this product may be legally used outside the USA

NOTE: It is recommended to use the same wire gauge is there are multiple connections to the same terminal

For more information regarding Gateway wiring instructions, see SWIFT manual LS10036-000FH-E or LS10036-000SK-E.

7.10.1 Power Connections for the Gateway

The WIDP-WGI or SK-WGI, Wireless Gateway acts as a bridge between a group of wireless fire devices and a SLC loop on the IFP-2100/ECS. It is powered by the SLC loops or by a regulated, external 24 VDC UL listed power supply. For updated details about wireless devices, system setup, and operation, see the *SWIFT™ Smart Wireless Integrated Fire Technology Instruction Manual P/N LS10036-000FH-E* if using IDP or *P/N LS10036-000SKFL-E* for SK.

Section 8: Programming Overview

This section of the manual is intended to give you an overview of the programming process. Please read this section of the manual carefully, especially if you are programming the control panel for the first time.

The JumpStart® AutoProgramming feature automates many programming tasks and selects default options for the system. JumpStart should be at least once when you are installing the system. See Section 8.1 for details. After you run JumpStart, you may need to do some additional programming depending on your installation. Section 9 of this manual covers manual programmable options in detail.

Programming the panel can be thought of as a four part process. You must program:

- Network options. This affects how all panels in the network work together. (see Section 6 Network Management for details).
- System options. These are options that affect general operation of the panel. (see Section 9.6 for details).
- Options for input points and zones. These are primarily options that control the detection behavior of devices. (see Section 9.3 and Section 9.5 for details).
- Options for output points and groups. This includes selecting characteristics for output groups and mapping output circuits to output groups. (see Section 9.4 for details).

8.1 JumpStart® AutoProgramming

The JumpStart AutoProgramming feature allows for faster system setup. When you run JumpStart AutoProgramming, the panel searches for expanders and SLC devices not currently in the system. The new devices are added in their default configuration. At the end of the JumpStart you can choose to not accept the new devices and go back to the configuration you had before. JumpStart saves the installer from having to program options for each device. Depending on the application, the installer may need to make some changes after JumpStart completes.

See Section 8.1.3 for complete details about running JumpStart.

8.1.1 Input Points

The first JumpStart on the panel in default configuration will determine the number and type of input points (detectors or contact monitor modules) on each SLC loop. JumpStart® AutoProgramming assigns the correct detector type (heat, ionization or photoelectric), so the installer does not need to edit the device type for detectors. Any contact monitor modules on the system will be assigned type “Manual Pull.” The installer will need to manually change the switch type if manual pull is not correct.

The first JumpStart AutoProgramming creates one zone (Zone 1) and assigns all input points to Zone 1. Zone 1 is mapped to Output Group 1.

8.1.2 Output Points

The first JumpStart AutoProgramming on a panel in default configuration creates three output groups and assigns output circuits as follows:

Internal Power Supply Circuits 1-8:

Configured as Notification and assigned to Group 1.

Internal Power Supply Circuit 9 (Relay 1):

Assigned to Group 998.

Internal Power Supply Circuit 10 (Relay 2):

Assigned to Group 999.

Addressable output points (Relay modules):

All addressable relay devices will be configured as “Output Pt” (general purpose output point) and assigned to Group 1.



NOTE: Relay output is constant even if the zone activating the relay is programmed with an output pattern.

8.1.3 Running JumpStart® AutoProgramming

Run JumpStart AutoProgramming immediately after you have addressed and connected all input devices (detectors, pull stations, and so on) and output devices (notification appliances, relays, and so on).



NOTE: If you need to install a few devices after you have run JumpStart, you can install them manually or run JumpStart again at a later time. JumpStart will keep user options, such as names, for devices already installed. Follow instructions in Section 8 for configuration.

To run JumpStart AutoProgramming, follow these steps.

1. Select 7 for Panel Programming. Enter Access Code.
2. Select 6 for JumpStart AutoProgramming.
3. The message “The system will be shut down during JumpStart.” Press ENTER to accept.
4. When the message, “SLC FAMILY” message appears, select IDP, SK or SD; depending on the type of SLC devices the panel is using, and press ENTER to accept.
5. A series of messages displays for the next several seconds. JumpStart scans the SLC loops for devices. This can take several minutes, depending on the number of devices attached.
6. If a Temp Programming Display is being used to initially setup an RFP-2100, a message will appear for selecting to install the display or not. If the display is to stay in the system for normal annunciation, select “Yes”. Otherwise select “No” and the display will be removed.” See Section 4.5.3.

7. When the message “Configuring System Done” displays, press any key to continue.
8. Select one of the following options from the menu that displays.

1 - Review System	Press 1 if you need to review the JumpStart configuration. The Review System menu will appear. Press 1 to review Entire System or Press 2 for Changes Only.
2 - Repeat JumpStart	Press 2 if you need to rerun JumpStart for any reason.
3 - Accept Changes	<ol style="list-style-type: none"> 1. If you are ready to make the JumpStart[®] configuration permanent, select 3. 2. The system will ask you if the installation contains any addressable duct detectors. If there are none, select 2 for No and skip to Step 8. If the system contains duct detectors, select 1 for Yes and continue with Step 3. 3. From the list that displays, select the SLC that contains the duct detectors. 4. The first photoelectric or ionization detector on the system will display. Select 1 for DUCT and 2 for NonDUCT. 5. Press up arrow to select the next detector. Select 1 for DUCT and 2 for NonDUCT. Continue until all duct detectors have been selected. (Note: You can move backwards through the list with down arrow). 6. When you reach the last detector on this device, press left arrow. 7. The system will ask you if there are any duct detectors used. If there are, select 1 for Yes and the message will ask, Have All Addressable Duct Detectors Been Identified? Left arrow for “No”, Right arrow for “Yes”. If there are no more duct detectors, continue with Step 8. 8. The system will restart with the saved JumpStart configuration. 9. After the system resets, it will use the new JumpStart configuration.
4 - Discard Changes	If you want to discard the changes, and keep the configuration you had before running this JumpStart press 4.

8.2 Mapping Overview

This section of the manual is a high level overview of mapping.

Mapping is an important concept with the control panel. In general terms, mapping is assigning or linking events to outputs that will activate when events occur. You do this by assigning input points to input zones, output points to output groups and then linking or mapping zones and output groups.

Figure 8.1 is a brief overview of the concept of mapping. The next several pages of the manual show these subjects in detail.

In its simplest application, mapping is determining which outputs are activated by which inputs.

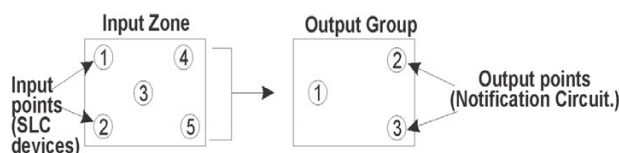

Because the Control Panel programming is so flexible, there are a number of uses for mapping, as shown in the diagram below.

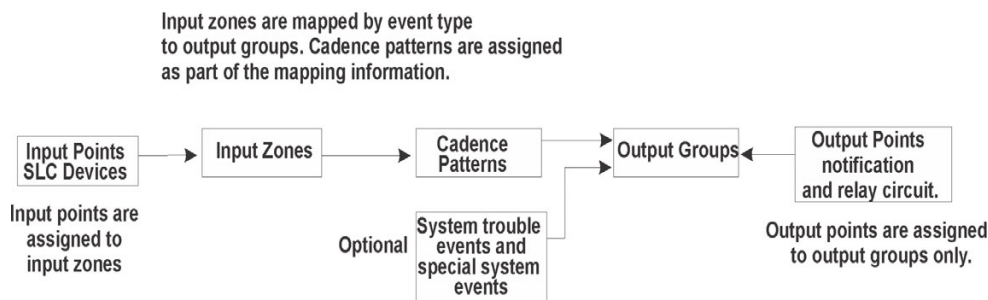

Figure 8.1 Mapping Overview



NOTE: Supervised notification Outputs mapped to General troubles on the NAC circuit should be made latching. Failing to do so will cause the circuit to continually cycle into and out of trouble until silenced or restored, if that circuit goes into trouble with an open or short condition.

8.2.1 Input Point Mapping

Input points are assigned to input zones, as the example in Figure 8.2 shows. Any input point can be assigned to any input zone. (Input points can be assigned to one zone only. An input point can be designated as “Unused,” which means it has not been assigned to a zone).

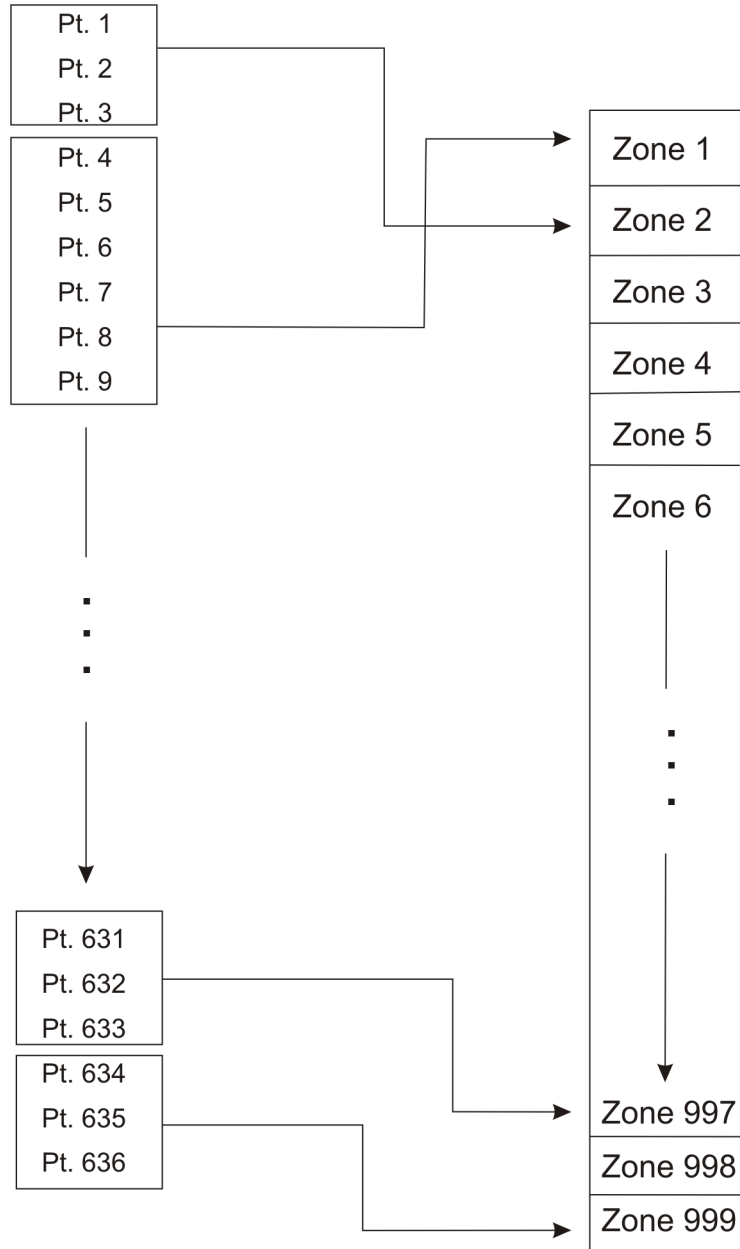

Figure 8.2 Example of Input Point Assignment

8.2.2 Output Circuit Mapping

Figure 8.3 is a simple example showing how to assign notification and relay output circuits to groups.

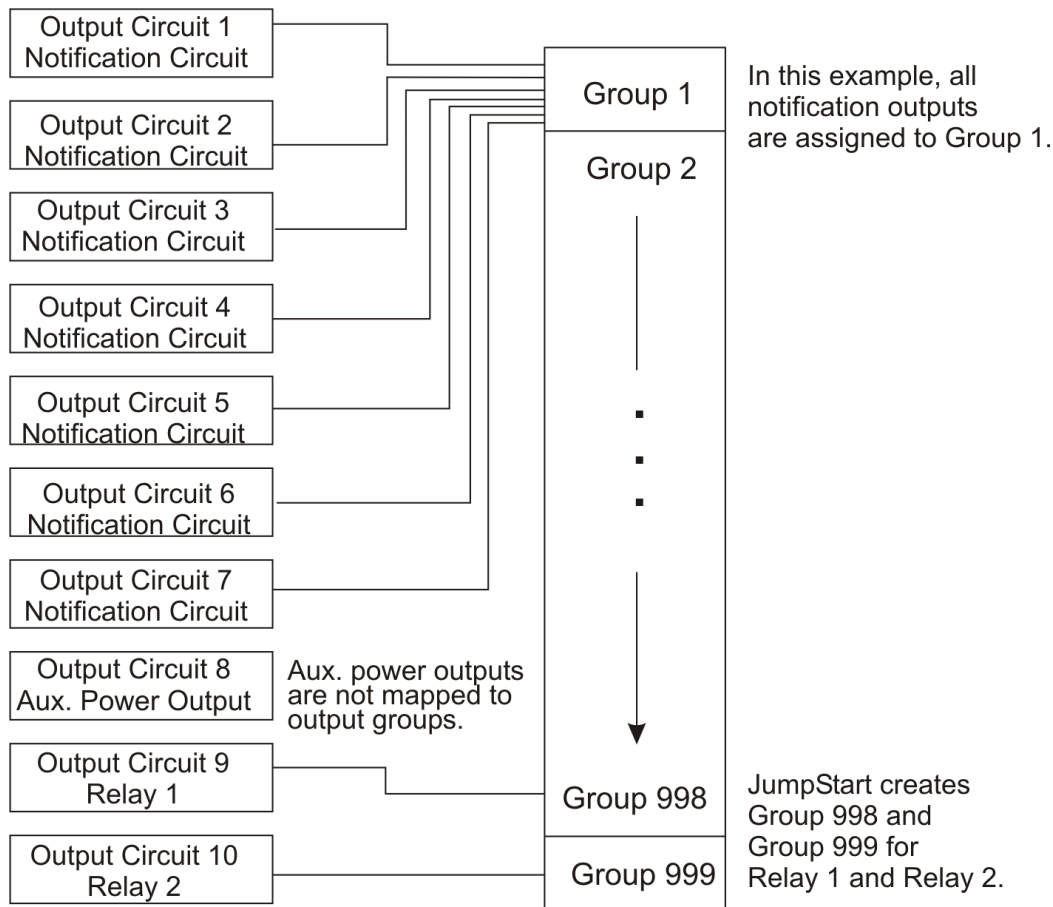

Figure 8.3 Example of Assigning Output Circuits to Groups

8.2.3 Event Mapping

There are 11 types of Zone events, 14 types of Panel events, and 40 types of Site events that can be mapped (see Table 8-1). For each event type, you can activate the output groups with specific output patterns. Mapping examples are shown in Figure 8.4, Figure 8.5, & Figure 8.6.

System	Zone	Panel	Site
Fire	Manual Pull Alarm	System Aux 1 Alarm	Fire Drill
	Water Flow Alarm	System Aux 2 Alarm	General Fire Alarm
	Detector Alarm (heat or smoke detectors)		General Fire Supervisory
	Zone Aux 1 Alarm		General Fire Pre-Alarm
	Zone Aux 2 Alarm		
	Interlock Alert		
	Interlock Release		
	Pre-Alarm		
	Fire Supervisory		
	Status Point		
	CO Alarm		
	CO Supervisory		

Table 8-1 Event Types

System	Zone	Panel	Site
Emergency			LOC ECS 1-8 Alarm
			General ECS Alarm
			General ECS Supervisory
			Point ECS 1-8 Alarm
Advisory	Trouble	SBUS Expander Trouble	General Trouble
	Status Point Active	SBUS Class A Trouble	Site Silenced
		SLC Loop Trouble	Voice Aux In 1-8 Alarm
		AC Loss Trouble	F1 Key Active
		Battery Trouble	F2 Key Active
		Ground Fault Trouble	F3 Key Active
		Phone Line Trouble	F4 Key Active
		Reporting Account Trouble	Voice Aux in 1-2
		Printer Trouble	System Mic Active
		Aux Power Trouble	Background Music
		System Switch Trouble	
		Output Group Trouble	

Table 8-1 Event Types

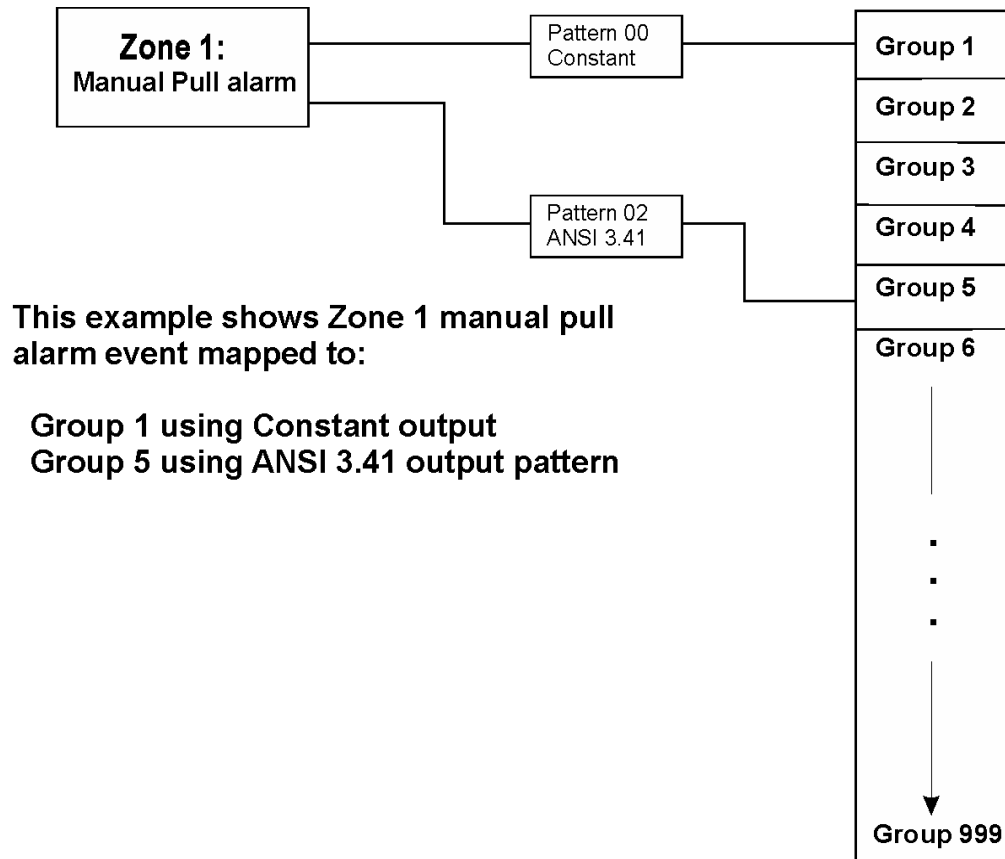

Figure 8.4 Example of Zone Events Mapped to output Groups and Patterns

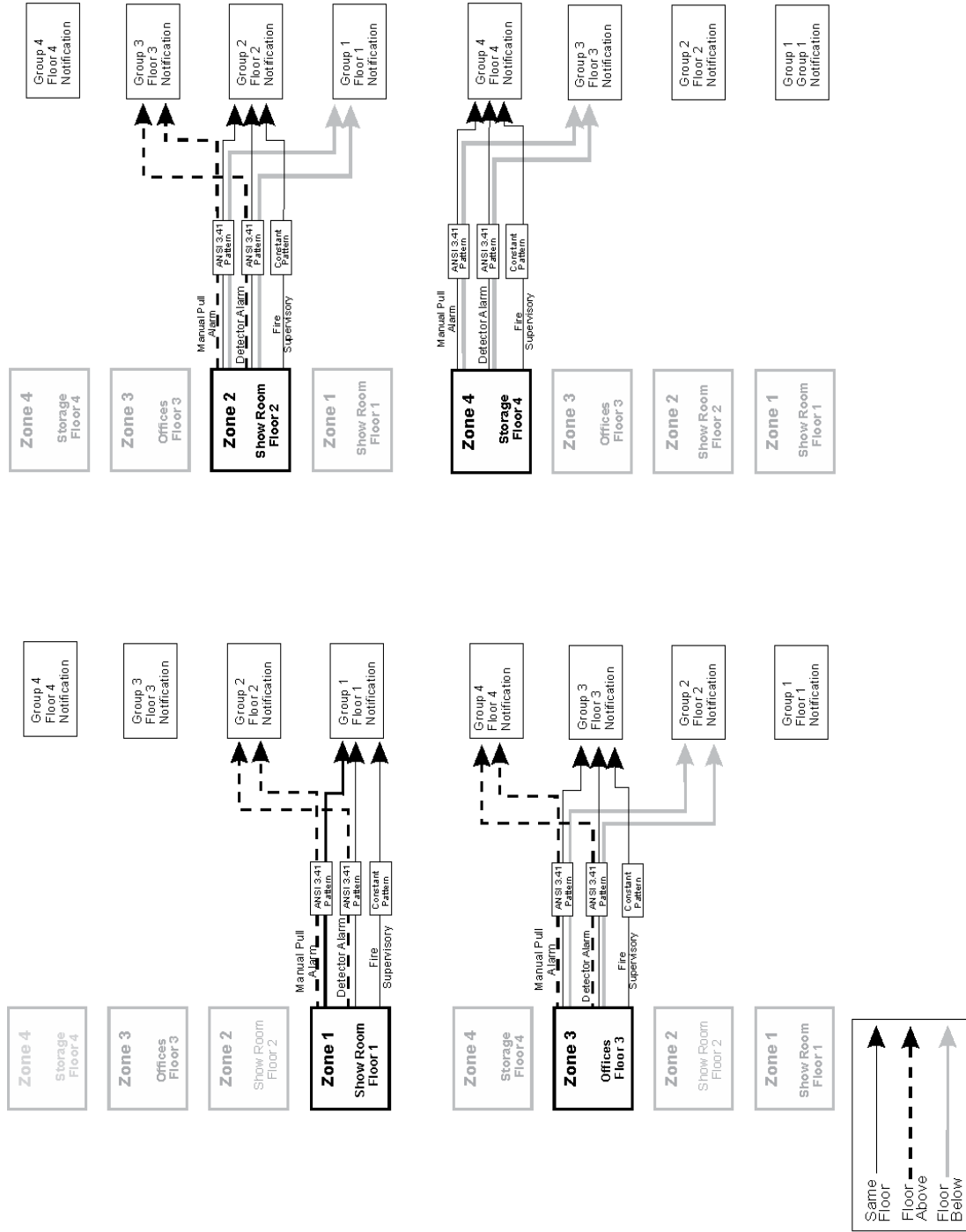

Figure 8.5 Example of Zone Events Mapped to Output Groups and Patterns on a Single Panel

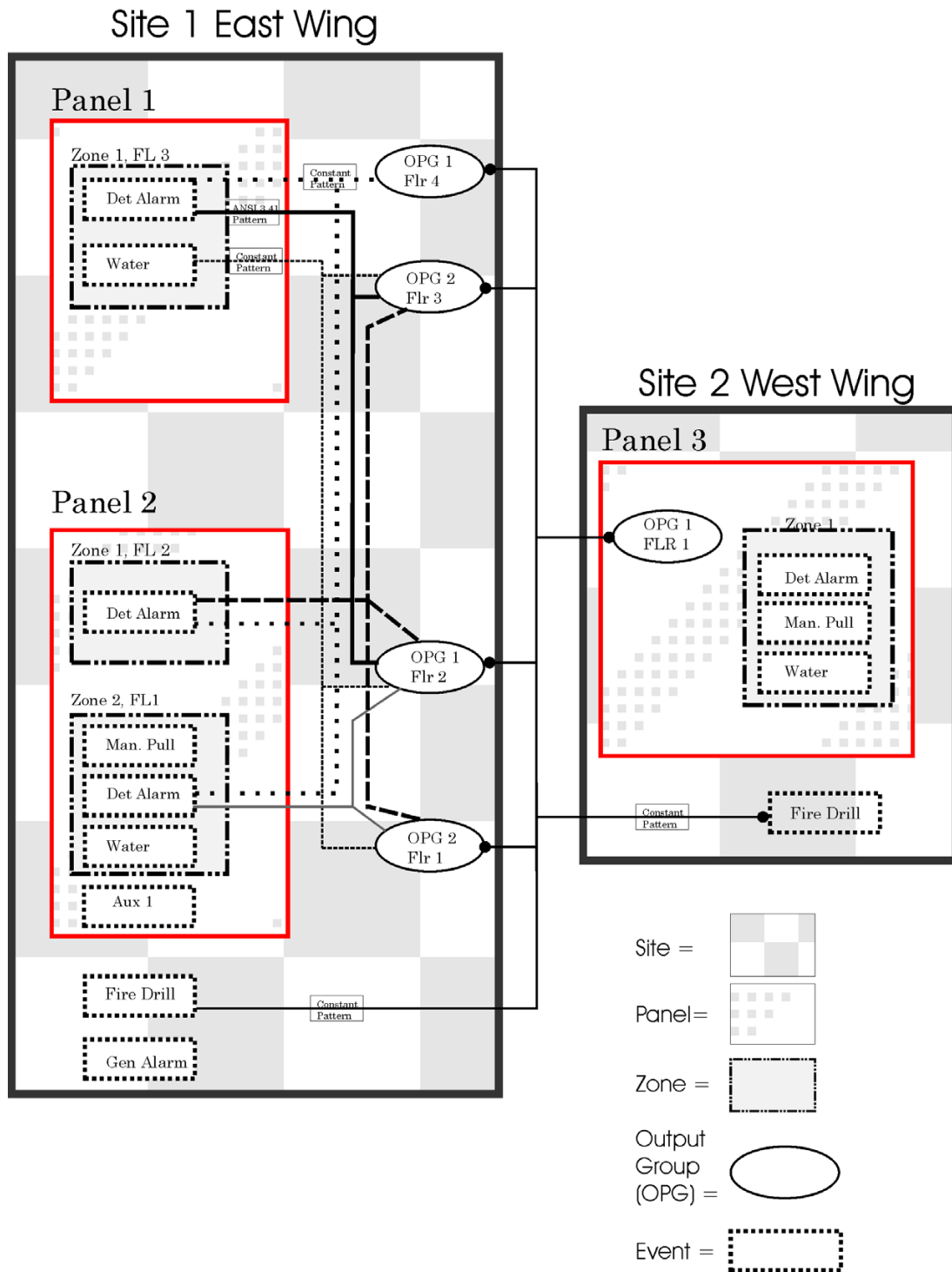

Figure 8.6 Example of Events Mapped to Output Groups and Patterns within a Networked Site

8.2.4 Mapping LED Points

Figure 8.7 is a simple example showing how LED points are mapped to zones and output groups. Typically you would create two output groups for each zone, one for alarms and one for troubles. (LED points are available when models 5865-3/4 and/or 5880 are used with the system).

Mapping LEDs to Zones and Output Groups

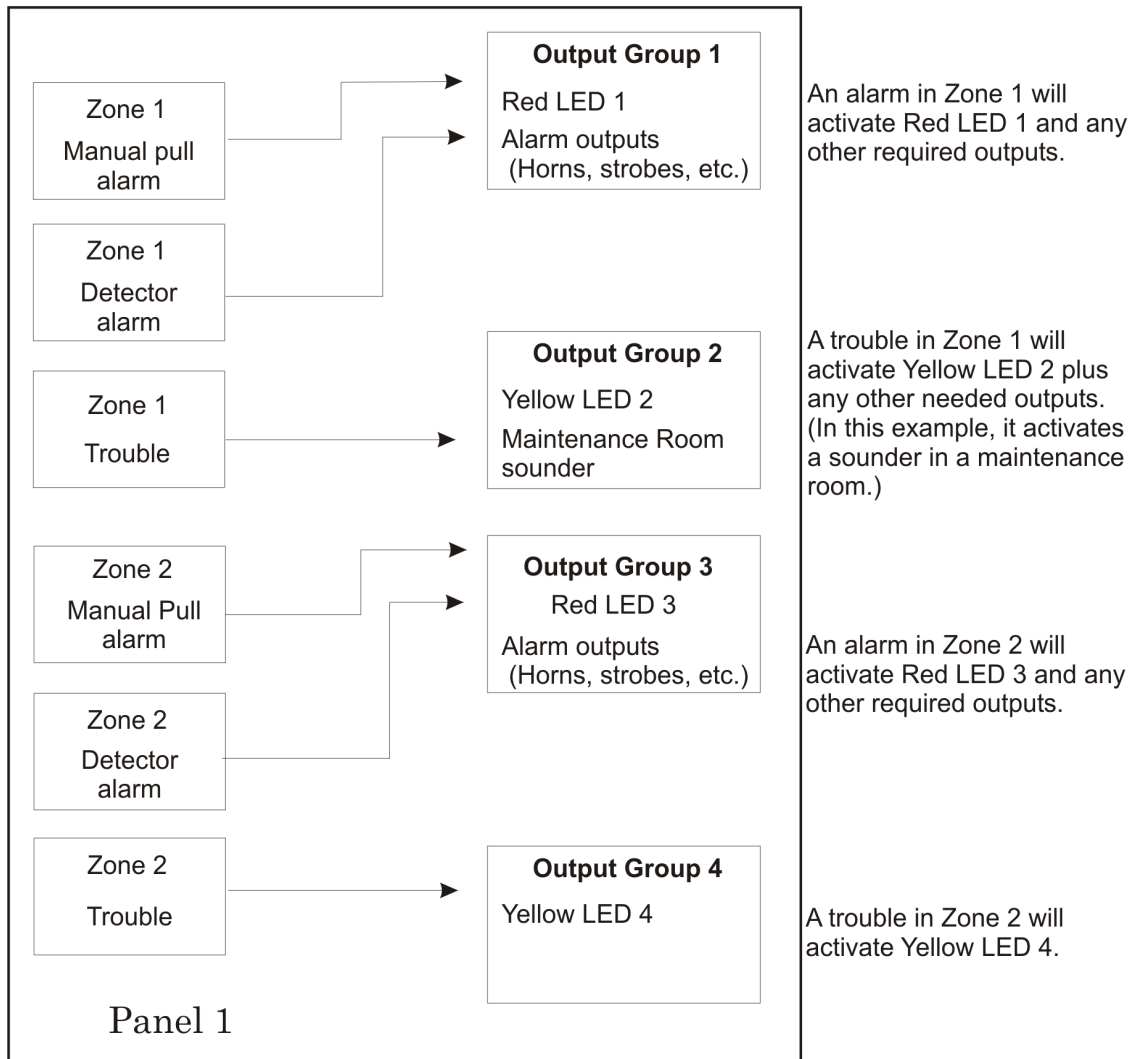

Figure 8.7 Example of LED Points Mapped to Output Groups (Applies to Models 5865-3/4 and 5880)

8.2.5 Mapping LED Points for a Networked System

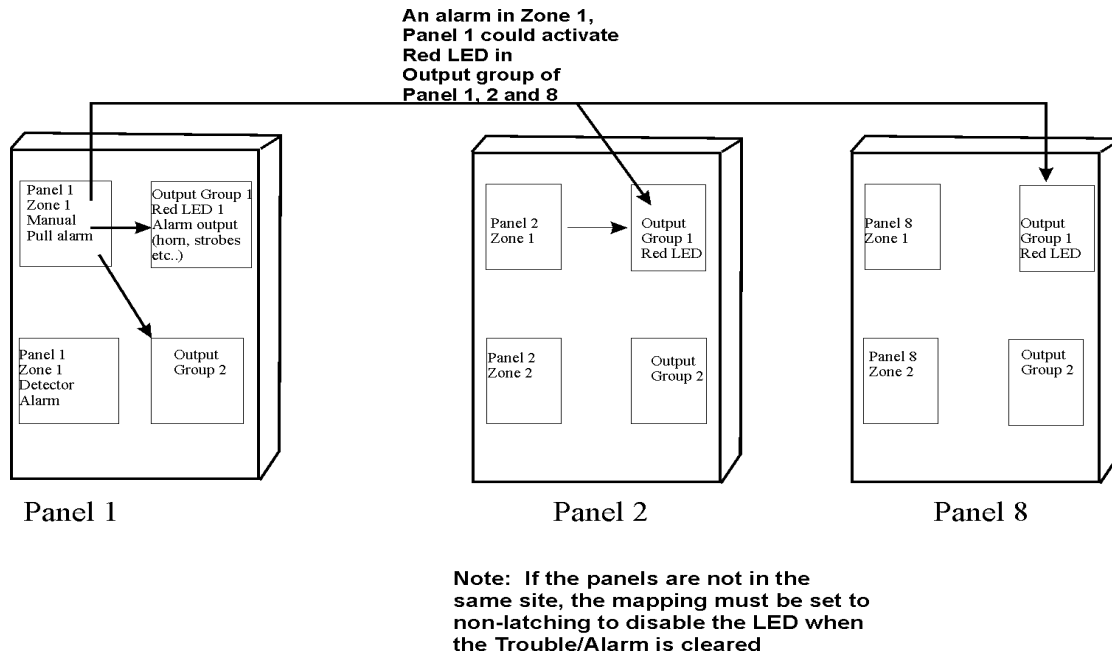

Figure 8.8 Example of Expanding Mapping of LED Points Across Panels

8.3 Programming Using the HFSS Honeywell Fire Software Suite

You can use the HFSS Honeywell Fire Software Suite software to program the control panel onsite (personnel will need to be onsite during the upload or download process). HFSS is a software package that lets you easily program the control panel using a Windows-based computer. HFSS is needed for Mapping. When using HFSS, you can set up the programming options for the panel, save the options in a file, then download the file to the panel. You can connect to the control panel directly using the onboard USB. Updates are available at www.farenhyt.com

8.4 Programming Using an Annunciator

Many of the features can be programmed through the system annunciator, using either the control panel's on-board annunciator or RA-2000, RA-1000, or RA-100 remote annunciators.

The following subsections describe programming basics, including a description of editing keys available for programming and how to move through programming menus. Section 9 contains specific information about individual programming options.

8.4.1 Entering / Exiting Panel Programming

To enter Program Mode:

1. Enter the Installer Code (factory programmed default code is 123456).
2. Select 7 for Programming Menu. See Section 9 for detailed menu information and Section 8.5 for a quick reference listing all programmable options and JumpStart defaults.

To exit Program Mode:

When you have completed working with the menus, press left arrow several times until you are exited from programming mode. Two prompts will display. The first prompt is to make sure you intended to leave the panel programming (select Yes or No as appropriate). The second prompt is for accepting all changes. If you select No, any changes you have made since you entered panel programming will have no effect.

Moving through the Menu

Figure 8.9 shows how to move through the menu screens, using the main menu screen as an example.

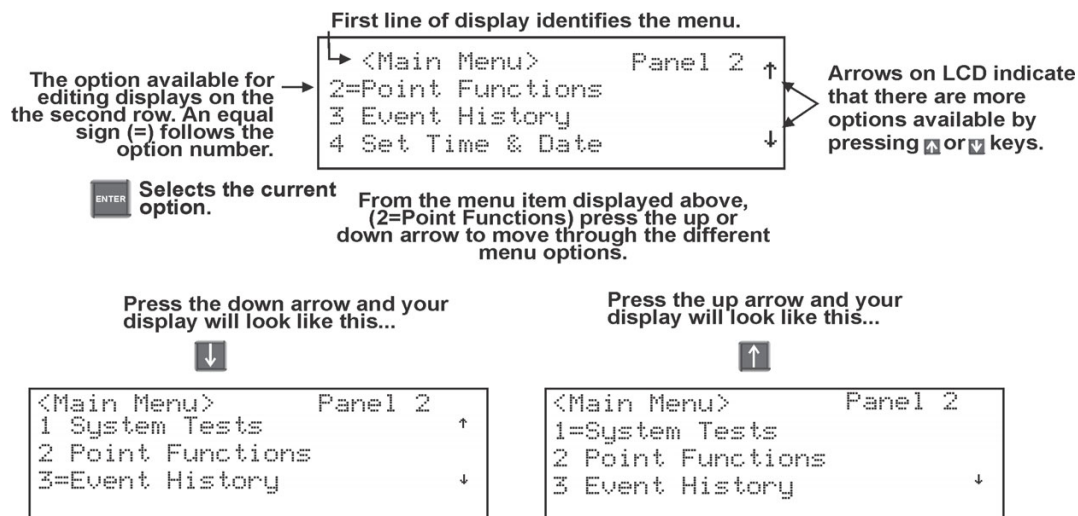

Figure 8.9 Moving through Main Menu (Main Menu used as an Example)

Selecting Options and Entering Data

There are several ways to make programming selections using the control panel depending on which screen you are currently viewing. The chart below is a generic explanation.

To	Press
Select from a menu.	The corresponding number on the annunciator.
Enter numeric data.	The appropriate number on the annunciator.
Enter text (alphanumeric data).	See Appendix B for complete list of characters.
Select from a scrolling list.	The up arrow or down arrow to move through the list of available options. When the option you want to select is displayed, press ENTER.

8.5 Programming Menu Quick Reference

This section of the manual lists all Panel Programming options in the order they appear on the sub-menus. Default settings are indicated in text or marked with an asterisk (*). The comments column provide quick information and a reference to a section (if applicable) which has more detailed information.

Menu		Options/Defaults		Comments
Module	Edit Module	Select Module	Edit Module ID	Section 9.2.1
			Enter Module Name	
			Edit Module specific options	
	Add Module	5824-Serial/Parallel/IO	RA-2000 LCD Annunciator	Section 9.2.2
			RA-1000 LCD Annunciator	
			RA-100 LCD Annunciator	
			6815 SLC Loop Expander	
			5815XL-SLC Loop Expander	
			RPS-1000 Power Supply	
			5496 NAC Expander	
			5880-LED/IO Module	
			5865-LED Annunc. Module	
			ECS-50W -Voice Amplifier	
			ECS-125W-Voice Amplifier	
			ECS-DUAL50W -Voice Amplifier	
ECS-INT50W-Voice Amplifier				
ECS-NVCM -Network Voice Control Module				
ECS-VCM-Voice Control Module				
ECS-RVM Remote Voice Module				
Module	Add Module	SK-NIC Network Interface Card	Section 9.2.2	
	Delete Module	Select Module	Section 9.2.3	
	View Module List	Select Module	Section 9.2.4	

Menu		Options/Defaults				Comments
Zone	Edit Zone	Select Zone	Edit Zone Name			Section Edit Zone Name
			Zone Properties	Verification Type	*1-Count	Section Edit Zone Properties
					2-Count	
					Alarm Ver.	
					PAS	
					SNGL ILOCK	
				DBL ILOCK		
				Heat Temp Set	135° to 150°F	SD devices Section 9.3.1
					135° to 190°F	IDP or SK device Section 9.3.1
		Smoke Sensitivity	Low	Section Edit Zone Properties		
	Medium					
	High					
	Zone Accessory Opt	Single/Multi-station Cadence	00-23	Section Zone Accessory Options		
		CO Single/Multi station Cadence	00-23			
		Local Zone	Yes			
			No			
	View Zone Points	Select Zone			Section 9.3.2	
Group	Edit Group	Select Group	Group Name			Section Edit Group Name
			Group Properties	Voice Group	Y or N	Section Edit Group Properties
				Switch	1-64	
				Template Override	Y or N	
				Allow Sys Override	Y or N	
		Dynamic Act/Template Override Cadence	00-23 (See Appendix C)			
	View Group Points	Select Group			Section 9.4.2	
	Edit OPG Template	Select template	Modify name and which OPGs are in template		Section 9.4.3	

Menu		Options/Defaults			Comments	
Point	SD, SK and IDP Devices on Internal and External 6815 and External 5815XL	Enter Pt	Select Module ^{4,5}	UNUSED		Section 9.5
				MANUAL PULL		
				WATER FLOW	*LATCH NON-LATCH	
				FIRE SUPERVSY	*LATCH NON-LATCH	
				FIRE DRILL		
				SILENCE		
				RESET		
				P.A.S. ACK		
				ZONE AUX1	*LATCH NON-LATCH	
				ZONE AUX2	LATCH NON-LATCH	
				SYSTEM AUX1	LATCH NON-LATCH	
				SYSTEM AUX2	LATCH NON-LATCH	
				DETECTOR		
				FIRE TAMPER	LATCH NON-LATCH	
				MANUAL RELEASE		
				INTERLOCK		
				STATUS POINT		
				CO DETECTOR SWITCH		
				CO SUPERVISORY DETECTOR SWITCH	LATCH NON-LATCH	
				ECS INPUT	LATCH NON-LATCH	
				ECS TAMPER	LATCH NON-LATCH	
				ECS SUPERVISORY	LATCH NON-LATCH	
				OUTPUT PT	Select Group	
				NOTIF ^{1,2,3,4,5,6}	AUX CONST	
					AUX RESET	
					AUX DOOR	

Menu		Options/Defaults			Comments		
Point (cont.)	SD, SK and IDP Devices on Internal and External 6815 and External 5815XL	Enter Pt	Select Sensor 4,5	RELAY ^{1,2,3,4, 5,6}	OUTPUT PT	Select Group	Section 9.5
					AUX RESET		
					AUX DOOR		
				SLC LED ^{1,6}	LED Number	1-80	
					LED Function	Notif Unused	
				DETECTOR 2,3,4,5	2-WIRE SMOKE	Select Zone	
				W. Gateway 2,3,4,5			
				W SWITCH 2,3,4,5, 8	Same as SWITCH		
				W- RELAY ^{2,3,4,5, 8}	Same as Relay		
				UNUSED			
				DETECTOR ^{1, 2,3,4,5,6}	PHOTO	No Accessory	
						SDR BAS 1,2,3,4,5,6	
						RLY BAS 1,2,3,4,5,6	
						I-SdrBa (Intelligent Sounder Base) 2,3,4,5,6	
					ION	No Accessory	
SDR BAS 1,2,3,4,5,6							
RLY BAS 1,2,3,4,5,6							
I-SdrBa (Intelligent Sounder Base) 2,3,4,5							

Menu		Options/Defaults					Comments
Point (cont.)	SD, SK and IDP Devices on Internal and External 6815 and External 5815XL	Enter Pt	Select Sensor	DETECTOR 1,2,3,4,5,6	HEAT ^{1,2,3,4,5,6}	No Accessory	Section 9.5
						SDR BAS 1,2,3,4,5,6	
						RLY BAS 1,2,3,4,5,6	
						I-SdrBa (Intelligent Sounder Base) ^{2,3,4,5}	
					PHOTO DUCT 1,2,3,4,5,6	No Accessory	
						DCT RLY	
					ION DUCT ^{1,6}	No Accessory	
						DCT RLY	
					2-WIRE SMOKE ^{1,6}		
					ACCLIMATE 2,3,4,5	No Accessory	
						SDR BAS	
						RLY BAS	
						I-SdrBa (Intelligent Sounder Base)	
					HEAT HT 2,3,4,5	No Accessory	
						SDR base	
						RLY base	
						I-SdrBa (Intelligent Sounder Base)	
					PHOT-HEAT 2,3,4,5	No Accessory	
						SDR BAS	
						RLY BAS	
I-SdrBa (Intelligent Sounder Base)							
BEAM ^{2,3,4,5}							
SUP DET 1,2,3,4,5,6	Same function as DETECTOR	LATCH					
		NON-LATCH					

Menu		Options/Defaults				Comments	
Point (cont.)	SD, SK and IDP Devices on Internal and External 6815 and External 5815XL (cont.)	Enter Pt	Select Sensor ^{4, 5} (cont.)	CO FIRE ^{2, 3, 4, 5}	CO ALARM/FIRE ALARM	No Accessory	
						SDR BAS	Single station or Multi station
						RLY BAS	Silence or Non- Silence
						I-SdrBA (Intelligent Sounder Base)	Latch or non- latch Single station or Multi station Silence or Non- Silence
					CO ALARM/FIRE SUPR	No Accessory	
						SDR BAS	Single station or Multi station
						RLY BAS	Silence or Non- Silence
						I-SdrBA (Intelligent Sounder Base)	Latch or non- latch Single station or Multi station Silence or Non- Silence
					CO SUPR/ FIRE ALARM	No Accessory	
						SDR BAS	Single station or Multi station
						RLY BAS	Silence or Non- Silence
						I-SdrBA (Intelligent Sounder Base)	Latch or non- latch Single station or Multi station Silence or Non- Silence
CO SUPR/ FIRE SUPR	No Accessory	Single station or Multi station					
	SDR BAS						
	RLY BAS						
	I-SdrBA (Intelligent Sounder Base)	Latch or non- latch. Single station or Multi station. Silence or Non- Silence					

Menu		Options/Defaults				Comments	
Point (cont.)	SD, SK and IDP Devices on Internal and External 6815 and External 5815XL (cont.)	Enter Pt	Select Sensor ^{4, 5} (cont.)	W-Detector 2,3,4,5,8	Photo 2,3,4,5 Acclimate 2,3,4 Photo-Heat 2,3,5 Heat 2,3,4,5	Section "Point Programming For Internal or External Power Module (RPS-1000)" on page 139	
				W-SUP DET 2,3,4,5,8	Same as W-Detector		
	Internal Power and External Power	Enter Pt /Select Function	Select Sensor	UNUSED		Section 9.5	
				B NOTIF	NOTIF OUTPUT CONTROL CIRCUIT		Select Group Super-vised Yes or No
				A NOTIF	NOTIF OUTPUT CONTROL CIRCUIT		Select Group Super-vised Yes or No
				AUX PWR	CONSTANT		
					AUX RESET		
					AUX DOOR		
					AUX SYNC ⁹		
				B SWITCH	MANUAL PULL		Latch and Non-Latch feature only appear for WATERFLOW, FIRE SUPERVISORY, FIRE TAMPER, ZONE AUX1, ZONE AUX2, SYSTEM AUX1, SYSTEM AUX2., ECS INPUT, ECS TAMPER, and ECS SUPERVISORY.
					WATER-FLOW		
					FIRE SUPERVISORY		
	FIRE TAMPER						
	FIRE DRILL						
	SILENCE						
	RESET						
	P.A.S. ACK						
	ZONE AUX 1						
	ZONE AUX2						
	SYSTEM AUX1						
	SYSTEM AUX2						
	MANUAL RELEASE						
	INTERLOCK						

Menu		Options/Defaults				Comments
Point (cont.)	Internal Power and External Power (cont.)	Enter Pt /Select Function	Select Sensor	B SWITCH	ECS INPUT	If ECS INPUT is selected choose associated EVENT
					ECS TAMPER	Latch and Non-Latch feature only appear for WATERFLOW, FIRE SUPERVISORY, FIRE TAMPER, ZONE AUX1, ZONE AUX2, SYSTEM AUX1, SYSTEM AUX2., ECS INPUT, ECS TAMPER, and ECS SUPERVISORY
	ECS SUPERVISORY					
	STATUS POINT					
	Enter Pt /Select Function (cont.)	Select Sensor	A SWITCH	Same as B SWITCH		Section 9.5.3
				B DETECT	2-WIRE SMOKE	
			4-WIRE SMOKE			
			CO 4 WIRE DET			
			CO 4 WIRE SUP DET		Latch	
			A DETECT	2-WIRE SMOKE		
4-WIRE SMOKE						
CO 4 WIRE DET						
CO 4 WIRE SUP DET	Non-Latch					
Select Group or Zone Number					Group or Zone selection will appear depending on the function selected	
Edit Name			Enter Name			
5496	Edit Point #	UNUSED			Section 9.5.5	
		B NOTIF	Control Circuit Notif Output	Select Group Super-vised Yes or No		
		A NOTIF				
		AUX_PWR	Constant			Edit Name
			Aux Sync			
Aux Door						
Aux Reset						
5880/5865/ECS-Series Amplifiers	Enter Point #	UNUSED			Section 9.5.4 and Section 9.5.6	
	Select Group	NOTIF				
	Edit Name			Enter Name		
ECS-VCM/ECS-RVM/ECS/NVCM	Enter Pt /Select Function	UNUSED			Section 9.5.7	
		SWITCH	MANUAL PULL			
			WATERFLOW			
			FIRE SUPERVISORY			
			FIRE TAMPER			
			FIRE DRILL			
			SILENCE			
			RESET			
			P.A.S. ACK			
			ZONE AUX1			
			ZONE AUX2			
			SYSTEM AUX1			
			SYSTEM AUX2			

Menu		Options/Defaults				Comments
Point (cont.)	ECS-VCM/ECS-RVM/ECS/INVCM	Enter Pt /Select Function	SWITCH	MANUAL RELEASE	Section 9.5.7	
				INTERLOCK		
				STATUS POINT		
				ECS INPUT		
				ECS TAMPER		
				ECS SUPERVISORY		
				VOICE AUX STATUS 1-2		
				BACKGROUND MUSIC		
				VOICE AUX ECS 1-4		
System Options	Communication Options	Auto Time Test	Set the Hour	*02:00AM	Section Auto Test Time	
			Set the Minutes			
			Select AM/PM			
			Enter Interval	24 hrs, 12 hrs, *6 hrs, 4 hrs		
		Phone Lines	For each phone line (1 & 2) select:			
			Dialing Prefix	Up to 9 digits	*none	Section Phone Lines
			# of Answer Rings	Range: 00-15	*06	Number of rings before panel answers a call from a computer Section Phone Lines
			Select Dialing Option	TT	*TT	Touch Tone
				TT/PL		TouchTone alternating with pulse see Section Phone Lines
				PULSE		Pulse dialing
			Rotary Pulse Format	U = 60/40 E = 66/34	*U	Section Phone Lines
			Dial Tone Disabled	Y or N	*N	
			Monitor Line	Y or N	*N	Section Phone Lines
			Answering Machine Bypass	Y or N	*N	Section Phone Lines
			Phone Line Unused	Y or N	*N	Section Phone Lines
			Edit Ethernet	IP Address		
		Subn Mask SubNet				
		Default Gateway				
		DHCP Enable				
		AlarmNet Timers	Ethernet Supervise	75 sec, 90 Sec, 3 min, 5 min, 1 hr, 24 hrs, 30 days, None	*5 Minutes	Section AlarmNet Timers
Cellular Supervise	24Hrs, 30 days, none		*24 Hours			
Old Alarm Time	10 min, 15 min, 30 Minutes, 1 hr, 2 hrs, 4 hrs, 8 hrs, 12 hrs, 24hrs, none		*30 Minutes			

Menu		Options/Defaults				Comments
System Options cont.	Communication Options	Phone Line Gains	Dialing	High	*High	Section AlarmNet Timers
				Low		
				Normal		
		Reporting	Low	*Low		
			Normal			
			High			
	Daytime/Nighttime Sensitivity	Enable/Disable	Yes	*No	Section 9.7	
			No			
		Day Start	Enter time	*6:00AM		
		Night Start	Enter time	*6:00PM		
		Days of the Week	Select days	*-MTWTF-		
	Holiday Days	Holidays 1 to 18	Enter dates	*01/01, 07/04, 12/24, 12/25	Section 9.7	
	Time Options	Water Flow Delay	0 - 90 Seconds	*1 sec	Water Flow delay is the number of seconds before a water flow alarm is generated. Section 9.7	
		Alarm Verify	60 to 250 seconds	*60 sec	Section Alarm Verify	
		Low AC Report Time	0 - 30 hours	*3 hrs	Low AC Report Delay. Section	
		AC Freq:	50 Hz	*60Hz	Section Change AC Line Frequency	
			60 Hz			
		Internal				
	Clock Display Format	AM/PM	*AM/PM	System Clock Format (AM/PM or military). Section		
		MIL				
Auto-resound	4 hours	*24 hours	Section Auto-Resound (4 or 24 hours)			
	24 hours					
Miscellaneous Options	SYNC Strobes when Silenced	Y	*N	Section Strobes Active when Silenced		
		N				
Auto Display Events	Y	*N	Section Auto Display Events			
	N					
Daylight Saving Options	Auto Daylight Saving Time	Y	*Y	Section Automatic Daylight Saving Adjustment		
		N				
	DST Start	Select week: 1st, 2nd, 3rd, 4th or Last	Select month		Section Daylight Saving Time Start and End	
DST End						
Edit Banner	Refer to Appendix B			Section 9.6.7		
SLC Family	IDP			Section 9.6.8		
	SD					
	SK					
Jump Start AutoPrg	Y (Yes) N (No)			Section 9.7		
Restore Defaults	Y (Yes) N (No)			Section 9.8		
Voice Options	VCM Maintenance	PC Connection		Section 9.9		
		Local Recording				
	Edit Voice Settings	Enable Dual Channel System				
*Default						

3. 1. Available on 5815XL External.
4. 2. Available on 6815 External.
5. 3. Available on 6815 Internal.
6. 4. Available with SLC Family as IDP.

7. 5. Available with SLC Family as SK.
8. 6. Available with SLC Family as SD.
9. 7. Requires ECS module programmed into the panel.
10. 8. Requires wireless Gateway.
11. 9. Aux Sync setting is only applicable for the B200S/IV Sounder Base.

Section 9: Programming

This section of the manual describes how to manually program the control panel from the built-in annunciator. Each subsection discusses these menu options in detail. All options described in this section can be performed using the HFSS - Honeywell Fire Software Suite.

IMPORTANT!

Before any customized programming is done, JumpStart AutoProgramming should be run first. After JumpStart is run, thoroughly test the system. The reason the system should be tested after JumpStart AutoProgramming is because JumpStart AutoProgramming automatically programs the system, searching for and configuring all SLC and SBUS devices it finds. JumpStart allows you to confirm the integrity of the installation prior to performing any custom programming. After determining that the hardware is properly installed, custom programming can be performed. Refer to Section 8.

9.1 UL 864 / UL 2572 Programming Requirements

NOTICE TO USERS, INSTALLERS, AUTHORITIES HAVING JURISDICTION, AND OTHER INVOLVED PARTIES: This product incorporates field programmable software. In order for the product to comply with the requirements in the Standard for Control Units and Accessories for Fire Alarm Systems, UL 864, and Stand for Mass Notifications Systems, UL 2572, certain programming features or options must be limited to specific values or not used at all as indicated below.

Programming Option	Menu Item	Permitted in UL 864 (Y/N)	Permitted in UL 2572 (Y/N)	Possible Settings	Settings Permitted in UL 864	Settings Permitted in UL 2572
Time Options	Auto-resound	Yes	Yes	4 hrs, 24hrs	4 hours if using SWIFT devices	4 hours if using SWIFT devices
Time Options	Low AC Report Delay	Yes	Yes	0-30 hours	1-3	1-3
Display Oldest Event	Y (Enabled)	Yes	Yes	Yes & No	Yes	Yes
	N (Disabled)	No	No	Yes & No	No	No
Initial Delay	0-28	Yes	Yes	0-28	3	3
Inter Message Delay	4-32	Yes	Yes	4-32	4-32	4-28
Alarm Verification	Alarm Verification	Yes	Yes	60-250 (confirmation period)	60	60
Auto Reset ECS MIC Triggered Event	Auto Reset ECS Custom Event	Yes	Yes	Never Timer Event Disabled	Never Timer Event Disabled	Never Timer Event Disabled
ECS Input	ECS Input	Yes	Yes	Latching Non-Latching	Latching	Latching
Event Priority	CO Alarm	No	No	Yes & No	No	No

9.2 Modules

This section lists the options available under the module option in the Panel Programming. The following modules are available for the control panel: 5824 serial/parallel/IO printer interface module, RA-2000, RA-1000 & RA-100 LCD remote annunciators, 5815XL SLC Loop expander for SD devices, 6815 SLC Loop Expander for IDP or SK, RPS-1000 power supply, 5496 NAC expander, 5880 LED I/O module, 5865 LED annunciator Module, ECS-50W, ECS-125W, or ECS-INT50W watt voice amplifiers, ECS-AMP audio/voice amplifier, ECS-DUAL50W dual channel amplifier, ECS-VCM voice control module, ECS-NVCM network voice control module, ECS-RVM remote voice module, and SK-NIC network Interface card.

9.2.1 Edit Modules

The features that can be edited when this option is selected are module ID, module name, or features that are specific to the module to be edited.

To edit an existing module:

1. Enter the installer code. The panel will automatically go to the main menu.
2. Select 7 for Panel Programming.



NOTE: If you are working on a networked system you will need to select which panel you want to program.

3. Press 1 to enter module menu.
4. Press 1 to edit a module.
5. Use the up or down arrow key to select the module you wish to edit. Then press ENTER.

Editing Module ID

- Press the up or down arrow key to modify the module ID.



NOTE: Internal devices, SK-NIC and ECS-NVCM are not able to have their module ID edited.

Naming Modules

You can assign an English name to a system hardware module to make it easier to recognize on a display.

- If you wish to edit the module's name, press ENTER on the module's name. Then, press the number keys corresponding to the character for the module's name (or press right arrow key to bypass editing the name).



NOTE: See Appendix B for editing names

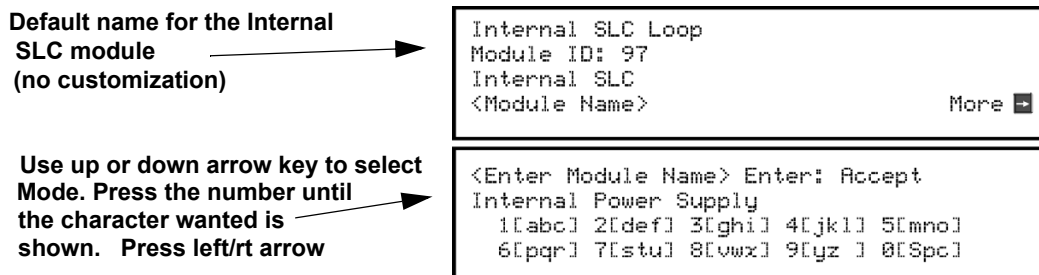

Figure 9.1 Edit module Name Programming Screen Example

Changing Module Options

Each module has a unique set of options that specifically applies to the functionality of the module being edited.

- Use the left and right arrow keys to move between available options.
- Option settings are edited by pressing the up or down arrow key or using the keypad for numerical entry.

9.2.2 Adding a Module

To add a new hardware module to the system, follow these steps:

You must be in the Main Menu to perform this task. If necessary, enter the Installer Code.

- Select 7 for Panel Programming.
- Press 1 to enter module menu.
- Press 2 to add a module.
- From the next screen, select the number that corresponds to the type of module you are adding from the <New Module Type> screen.

The screen will display “Adding module [#]...” for a few moments. You will be returned to the <New Module Type> screen where you can add additional modules if desired.

You must save changes when you exit the Panel Programming or the new module will not be added.



NOTE: If you Add a Module that has not been physically connected, the panel will go into trouble after it reinitializes (when you exit the Panel Programming). When the new module is attached, the trouble will correct itself automatically

9.2.3 Deleting a Module

To delete a module, follow these steps:

You must be in the Main Menu to perform this task. If necessary, enter the Installer Code.

- Select 7 for Panel Programming.
- Press 1 to enter module menu.
- Press 3 to delete a module.
- Select the module to be deleted.
- A warning screen will display. If you want to proceed with deleting the module, select Yes. To cancel, select No.

9.2.4 View Module List

To view a list of all modules, follow these steps:

You must be in the Main Menu to perform this task. If necessary, enter the Installer Code.

- Select 7 for Panel Programming.
- Press 1 to enter module menu.
- Press 4 to view list. Use the up or down arrow key to scroll though list.

9.3 Zone

Through the zone option in Panel Programming you can edit and view zone points. Selections made here affect all detectors and switches in the zone. Up to 999 zones can be used in each panel.

9.3.1 Edit Zone

Features that can be edited through the edit zone option are, edit zone name, zone properties (which includes zone type and detector sensitivity), and zone accessory options.

To edit a zone, follow these steps:

1. Enter the installer code. The panel will automatically go to the main menu.
2. Select 7 for Panel Programming.
3. Press 2 to enter zone menu.
4. Press 1 to edit a zone.
5. Enter the zone number, then press ENTER.

Edit Zone Name

6. Press 1 to edit the selected zone name. You can use words to display a descriptive name for a zone.



NOTE: See Appendix B for editing names

Edit Zone Properties

Zone properties consist of alarm delay characteristics, heat detector sensitivity, and smoke detector sensitivity.

1. Do steps 1 through 5 of Section 9.3.1.
2. Press 2 to edit the properties of the selected zone.

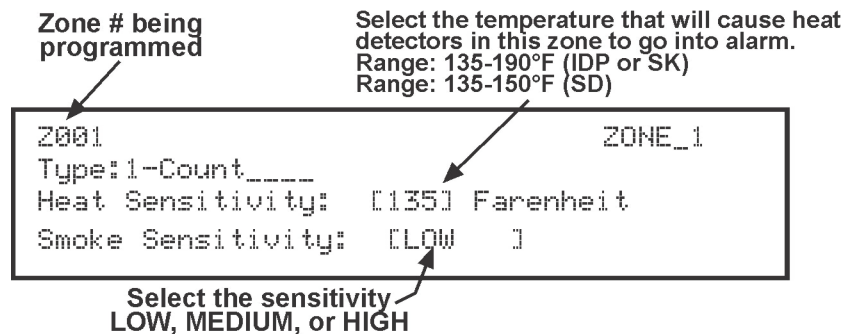

Figure 9.2 Editing Zone Properties



NOTE: You only see smoke sensitivity on the IFP-2100/ECS if the daytime/nighttime sensitivity is off under System Options. (See Section 9.6.2). Otherwise if you have Daytime/Nighttime sensitivity on, this will bring up a Smoke Sens Day and Night, 2 separate widgets with sensitivity selection being either low, med or high for each

■ Alarm Delay Characteristics

The programmed zone type is provided for user reference only. To modify the zone type use the HFSS Software Suite.

Table 9.1 list the detector characteristics and a description of each.

Type of Delay	Description
1-Count	One Count (No Delay). When this option is enabled, an alarm occurs immediately when a single device of any of the following types goes into alarm: detector, manual pull, water flow, Zone Aux1 or Zone Aux2. This is considered the most typical operation and is the default for all zones.
2-Count	When this type of alarm delay is used, two or more detectors within the zone must go into alarm in order for the zone to report an alarm. Switches of type manual pull, Detector switch, water flow, Zone Aux1 and Zone Aux2 are an exception; they will cause an alarm when only one switch is in alarm. When a single detector is in alarm in a 2-Count zone, the system enters a prealarm condition. In a prealarm condition, the touchpad PZT beeps and the annunciator display indicates that a prealarm has occurred. If the zone has been mapped to an output group for the prealarm event, the output group will activate. The prealarm will not be reported to the central station.
Alarm Verification	Alarm verification is an optional false alarm prevention feature that verifies an alarm condition by resetting the smoke detector. If the alarm condition still exists by the time the reset cycle has completed, the detector will go into alarm. If the detector is no longer in alarm, no report will go to the central station. The alarm verification sequence is ignored if the zone is already in alarm.

Table 9.1 Detector Characteristics

Type of Delay	Description
P.A.S.- Positive Alarm Sequence	<p>This option is intended to be used with an acknowledge switch. An alarm is delayed for 15 seconds, giving on-site personnel a chance to investigate the alarm. If the acknowledge switch is not activated within 15 seconds, an alarm occurs automatically.</p> <p>If this option is enabled for a zone, the zone will respond to an alarm condition as follows:</p> <ul style="list-style-type: none"> The zone will not go into alarm for 15 seconds to allow an on-site operator to activate the acknowledge switch. If the operator does not press the acknowledge switch within 15 seconds, the zone will go into alarm. If the operator presses the acknowledge switch within 15 seconds, a 180-second time-frame will begin counting down. This time-frame allows the operator to investigate the cause of the alarm. If the operator performs a reset within 180 seconds, the alarm will not occur. If the operator does not perform a reset within 180 seconds, an alarm will occur automatically. The P.A.S. feature will be overridden if another alarm occurs.
Single Interlock	See Section 10.7.1 for single interlock releasing operation.
Double Interlock	See Section 10.7.2 for double interlock releasing operation.
NOTE: IDP-FIRE-CO, SK-FIRE-CO and other CO detectors can only be installed in a 1 count zone; they will operate as a 1-count point regardless of the programmed zone type (i.e. Alarm Verification, 2 count etc.).	

Table 9.1 Detector Characteristics

■ Heat Detector Sensitivity

Use this feature to set the temperature at which high temperature detectors will respond. All detectors in the zone will respond in the same way. The range for IDP-HEAT-HT or SK-HEAT-HT heat detector is from 135°F to 190°F, for SD505-HEAT the range is 135° to 150°F.

The high temperature IDP or SK heat detectors are absolute temperature devices. This means that they respond to an alarm immediately if the temperature in the zone goes above the programmed temperature.

- Enter the temperature at which the heat detector will respond, or use the up or down arrow key to scroll through the range, or enter directly from the number keys on the annunciator, then press ENTER.

■ Smoke Detector Sensitivity

IMPORTANT!

Drift compensation is automatic for all smoke detectors (photoelectric and ionization). The feature is always in effect, no programming is required. See Section 10.4.11 for information about how to check if a detector is in UL compliance.

All detectors in the zone will respond as programmed in this menu location.

Detector Protocol	Type of Smoke Detector	Choices	Comments	
IDP/SK	PHOTO, ACCLIMATE, & PHOTO-T	Low (3.5% obscurity)	If the day/night sensitivity option is selected, you can have different sensitivity settings during the day and at night. You can program the days of the week that Day/Night Sensitivity will automatically adjust. You can also designate specific days as holidays. Holiday and weekend days use night sensitivity for the entire day.	
		Medium (2.5% obscurity)		
		High (1.5% obscurity)		
	DNR with PHOTOR or Photo	Low (2.5% obscurity)		
		Medium (2.0% obscurity)		
		High (1.5% obscurity)		
SD	SD505-PHOTO	Low	If the day/night sensitivity option is selected, you can have different sensitivity settings during the day and at night. You can program the days of the week that Day/night sensitivity will automatically adjust. You can also designate specific days as holidays. Holiday and weekend days use night sensitivity for the entire day.	
		Medium		
		High		
	SD505-DUCT with SD505-DUCTR	Fixed		Low, Medium and High settings have no effect for photoelectric duct detectors. Photoelectric duct detector sensitivity is always 1.1% per foot. Day and night settings also have no effect on these detectors.
		Fixed		Low, Medium, or High settings have no effect for ionization duct detectors. Ionization duct detector sensitivity is always 75 MIC (0.8%) regardless of Low, Medium or High setting. Day and night settings also have no effect on these detectors.

Table 9.2 IDP/SK and SD Sensitivity Choices

- Automatic drift compensation is always in effect for all detectors. See Section 10.4.11 for information about how to check if a detector is in compliance.

- Use the up or down arrow key to scroll through the range or enter directly from the number keys on the annunciator, then press ENTER.



NOTE: If the SLC protocol is changed from IDP/SK to SD and a zone's sensitivity is higher than the SD limit, the zone sensitivity will be set to the max value, 150, for the SD family.

Zone Accessory Options

- Do steps 1 through 5 of Section 9.3.1.
- Press 3 to edit the Zone's Accessory options.

Single or Multi-Station cadence pattern (choose from Patterns 00 to 02, 23 if using IDP or SK. Choose from 00-16, 23 if using SD devices). See Appendix C.

CO Single and Multistation Cadence (choose from Cadence Patterns 00 to 02, 23 for IDP or SK devices).



NOTE: The B200S / IV Sounder base provides the recommended CO cadence pattern

Local Zone (choose Y or N, for Yes or No).



NOTE: If the SLC protocol is changed from SD to IDP/SK series and the cadence is no longer valid for IDP/SK, the zone cadence will be set to constant on.

9.3.2 View Zone Points

To view the points in a zone, follow these steps:

- Enter the installer code. The panel will automatically go to the main menu.
- Select 7 for Panel Programming.
- Press 2 to enter zone menu.
- Press 2 to view zone points.
- Enter the number of the zone you wish to view, then press ENTER.

9.4 Group

An output group is made up of output points that have been programmed to respond in the same way. Output groups simplify programming because you only have to program the output characteristics that are common to all of the group points once, instead of programming each individual point. Once you have defined the characteristics of output groups, you can assign each point to the appropriate group. All valid output points are assigned to only one output group. Unused points are not assigned to any output group. Up to 999 output groups can be defined per pane

9.4.1 Edit Group

In the edit group option you can program the name of an output group (Section Edit Group Name) and change the properties (Section Edit Group Properties) of that group.

To edit a group, follow these steps:

- Enter the installer code. The panel will automatically go to the main menu.
- Select 7 for Panel Programming.
- Press 3 to enter group menu.
- Press 1 to edit group.
- Enter the number of the group you wish to edit, then press ENTER.

Edit Group Name

- To edit the group name, press 1.

You can use words to display a descriptive name for a group.



NOTE: See Appendix B for editing names

Edit Group Properties

- To edit the group properties, Press 2 from the edit group menu.

The Edit Group Menu allows you to select options for each group for the following items:



NOTE: These settings only apply to non-voice groups

- Select Y for voice group and N for non-voice group.
- Select / Dynamic Activation switch number: used when the group is defined as a voice group; or as a non-voice group where Dynamic Activation is used. This option links the output group with a voice select switch on a VCM, RVM, or switch expander for dynamic activation/deactivation.
- Template Override is shown when set to Yes.
- Dynamic Activation -Is shown if a non-voice group is assigned to a Select/Dynamic Activation switch number

- Dynamic Activation / Template Override Cadence. (This is shown when the Template override is set to Yes and Dynamic Activation is Yes): this setting sets the cadence of the non-voice group mapped to voice select switch when activated using dynamic activation or by a template.

■ Defining Output Group Type

Each output group is defined as either a voice output group or a non-voice output group. Output points that are audio circuits (all circuits on the ECS-50W, ECS-125W, ECS-DUAL50W, ECS-INT50W and ECS-CE4) can only be assigned to voice output groups. Output points that are non-voice circuits (all other points and circuits that are on all modules except the ECS-50W, ECS-125W, ECS-DUAL50W, ECS-INT50W and ECS-CE4) are assigned to non-voice output groups.

Each of the output groups defined as voice can be mapped to a particular switch and LED on the ECS-VCM/ECS-NVMC, ECS-RVM and ECS-SW24. This allows the user to see the state of the voice groups assigned to the switches.

This also lets the user individually select which areas they want to do a live page into. Output groups not defined as voice groups can also be assigned to these switches as long as there is a voice group already assigned to the group. This allows for dynamically activating/deactivating both voice and strobes/other outputs in an area with a single button press. See Activating Output Groups Dynamically.

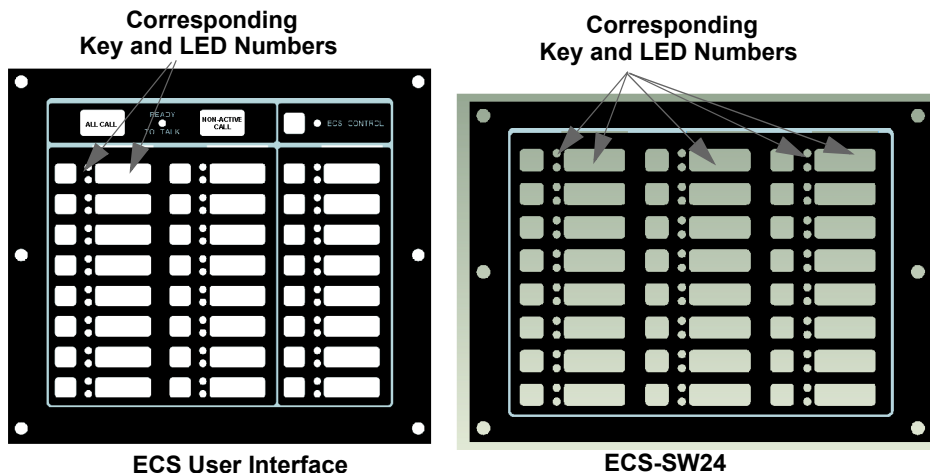

Figure 9.3 Corresponding Key and LED for Mapping Output Groups

■ Silencing Options

The following silencing options are available for each output group.

Optional Timers	Description
Silence Inhibit	Timed Silence after Inhibit. If this option is selected, the output group must be audible for a programmed number of minutes before it can be silenced. If the condition that caused the output to activate has not cleared during the time-frame, the output can be silenced. If you select this option, select the timeframe in the delay field. Range is 0-60 minutes.
Auto Silence	Silenceable. The output group will automatically silence after the timer expires. Range is 0-60 minutes.
Auto Unsilence	If this option is selected, the output group can be silenced for a programmed time-frame. If the condition that caused the output to activate has not cleared during the time-frame, the output reactivates. If you select this option, select the time-frame in the delay field. Range is 0-60 minutes.
Startup Delay	When a alarm is generated, the Output group will not activate until the timer expires assuming the event is still active. Range is 0-120 Seconds

Table 9.3 Silencing Options

9.4.2 View Group Points

1. Enter the installer code. The panel will automatically go to the main menu.
2. Select 7 for Panel Programming.
3. Press 3 to enter group menu.
4. Press 2 to view group points.
5. Enter the group number, then press ENTER.

9.4.3 Edit OPG Template

1. Enter the installer code. The panel will automatically go to the main menu.
2. Select 7 for Panel Programming.
3. Press 3 to enter group menu.
4. Press 3 to edit OPG Template.
5. Enter the Template number, then press ENTER

6. Press ENTER on the template name to edit the name.
You can use words to display a descriptive name for a group.



NOTE: See Appendix B for editing names.

7. Right arrow to the OPG and select YES or NO to select which output groups to include in the template.

9.5 Point

You may need to change characteristics of individual input points (detectors and switches) even after using JumpStart AutoProgramming. This section explains how to change options for: type of input point; latching/non-latching status (switches); and name and zone/group assignment of a point.

9.5.1 Point Programming For 5815XL Module

To program for points on an 5815XL module, follow these steps:

1. Enter the installer code. The panel will automatically go to the main menu.
2. Select 7 for Panel Programming.
3. Press 4 to enter point menu.
4. Press the up or down arrow key to select the desired module. Refer to Section 8.5 Quick Reference Table for available choices. Then press ENTER.
5. Enter the number of the point you wish to edit, then press ENTER.
6. Select the type of device by pressing the up or down arrow key. Refer to Table 9.4 under the column heading “Type Selection” for a list of choices.

Type Selection	Function	Latching Option	Comments
UNUSED			Select for SLC points that are unused.
DETECTOR	PHOTO		Spot photoelectric detectors.
	ION		Spot ionization detector.
	HEAT		Spot heat detector.
	PHOTO DUCT		Duct photoelectric detector.
	ION DUCT		Duct Ion detector.
	2-WIRE SMOKE		2-wire smoke detector.
SUP DET	PHOTO	Latching	Use this option when you want a detector to indicate a supervisory alarm.
	ION	Non Latching	
	HEAT		
	PHOTO DUCT		
	ION DUCT		
SWITCH	MANUAL PULL		Use this switch type for manual pull stations. This input is always latched. The switch can clear only when an alarm is reset. This switch type has the highest fire priority; it overrides any other type of fire alarm.
	WATERFLOW	Latching	Use this switch type for monitoring water flow in a sprinkler system. Switch closure will cause a sprinkler alarm. Water flow switches can be programmed as latching or non-latching. You can program a delay of up to 90 seconds to be used with a water flow switch. The delay allows for normal, brief changes in sprinkler system water pressure. The water flow alarm will not activate unless the switch is active for the programmed delay time. If a delay is used, the system begins counting down when the switch closes. If the switch opens (restores) before the timer expires, a water flow alarm is not generated. If the water flow switch remains closed after the timer expires, a water flow alarm will be generated.
		Non Latching	
	FIRE SUPER-VISORY	Latching	Use this switch type for tamper monitoring of sprinklers and other fire protection devices. If a contact closes, a sprinkler supervisory event will be generated. Supervisory switches can be latching or non-latching.
		Non Latching	
	FIRE DRILL		System-level, non latching switch. This switch is an alternative way of causing a fire drill. It has the same operation as the fire drill option available from the annunciator. When the switch is activated, a fire drill begins; when the switch is de-activated, the fire drill ends.
	SILENCE		This system-level switch is an alternative way to silence the fire system. It has the same effect as pressing the Silence key.
	RESET		This system-level switch is an alternative way to reset the fire system. It has the same effect as pressing the Reset key.
	P.A.S. ACK		Positive acknowledge switch. This switch must be used in zones programmed as Positive Alarm Sequence (see "Edit Zone Properties" on page 130 "Table 9.1 list the detector characteristics and a description of each." on page 130). If an acknowledge switch closes when an alarm or trouble condition is not already in progress, a trouble will occur. You must use a UL listed normally open, momentary switch type. The switch must be rated at 5V, 100 mA (minimum) and be used with an EOL resistor for supervision.
	ZONE AUX1	Latching	Use these switch types if you want to monitor special zone-level conditions (such as dry contact from a remote power supply).
		Non Latching	
	ZONE AUX2	Latching	
		Non Latching	
	SYSTEM AUX1	Latching	Use these switch types if you want to monitor special system-wide conditions (such as dry contact from a remote power supply).
		Non Latching	
	SYSTEM AUX2	Latching	
Non Latching			
DETECTOR		Used to monitor conventional 4-wire detectors, a contact closure will generate a detector alarm event.	

Table 9.4 Programming Options for 5815XL Modules

Type Selection	Function	Latching Option	Comments
SWITCH (cont.)	FIRE TAMPER	Latching	Performs identically to a supervisory switch, but will be indicated as a tamper switch on the LCD annunciator.
		Non Latching	
	MANUAL RELEASE		Manual release switch
	INTERLOCK		Interlock release switch input.
	STATUS POINT		
	ECS INPUT	Latching	User also has ECS Event Number 1-8 option for ECS INPUT. Only available when an ECS-VCM is installed in the system.
		Non Latching	
	ECS TAMPER	Latching	
		Non Latching	
	ECS SUPERVISORY	Latching	
Non Latching			
CO DETECT SWITCH		CO Detector Switch	
CO SUPERVISORY DETECT SWITCH	Latching	CO Supervisory Detector Switch	
	Non Latching		
NOTIF	OUTPUT PT	Select Group	Output point, a general use notification type. Use for driving standard notification appliances.
	AUX CONST		Use constant power for applications that require a constant auxiliary power source. Power is always present at constant circuits.
	AUX RESET		Use for auxiliary power, resettable applications. See Section 4.15.5 for a description of how this option operates.
	AUX DOOR		Use for auxiliary power, door holder applications. For example, if you were using an auxiliary power supply for door holders, you would use this option. See Section Door Holder Power for a description of how this option operates.
RELAY	OUTPUT PT	Select Group	Output point, a general use relay type. Use for applications requiring a relay, such as fan shutdown, elevator recall, and so on.
	AUX RESET		Use for auxiliary power, resettable applications. See Section 4.15.5 for a description of how this option operates.
	AUX DOOR		Use for auxiliary power, door holder applications. For example, if you were using an auxiliary power supply for door holders, you would use this option. See Section Door Holder Power for a description of how this option operates.
SLC LED	LED NUMBER	01-80	For use with SD devices only. 80 sub addresses on LED.
	LED FUNCTION	Unused	
		NOTIF	

Table 9.4 Programming Options for 5815XL Modules

9.5.2 Point Programming For 6815 Module

To program for points on an 6815 module, follow these steps:

1. Enter the installer code. The panel will automatically go to the main menu.
2. Select 7 for Panel Programming.
3. Press 4 to enter point menu.
4. Press the up or down arrow key to select the desired module. Refer to Section 8.5 Quick Reference Table for available choices. Then press ENTER.
5. Select S for sensor or M for module. (IDP or SK Only)
6. Enter the number of the point you wish to edit, then press ENTER.
7. Select the type of device by pressing the up or down arrow key. Refer to Table 9.5 under the column heading “Type Selection” for a list of choices.

Type Selection	Function	Latching Option	Comments
UNUSED			Select for SLC points that are unused.

Table 9.5 Programming Options for 6815 Modules

Type Selection	Function	Latching Option	Comments
DETECTOR	PHOTO		Spot photoelectric detectors.
	ION		Spot ION detectors
	HEAT		Spot heat detector.
	PHOTO DUCT		Duct photoelectric detector.
	ACCLIMATE		Acclimate photoelectric detector.
	HEAT HT		High temperature heat detector.
	PHOTO-HEAT		Photoelectric detector with heat sensor.
	BEAM		Beam smoke detector.
SUP DET	PHOTO	Latching Non Latching	Use this option when you want a detector to indicate a supervisory alarm.
	ION		
	HEAT		
	PHOTO DUCT		
	ACCLIMATE		
	HEAT HT		
	PHOTO-HEAT		
	BEAM		
CO SMOKE DETECTOR	CO ALRM / FIRE ALRM		No Accessory, Sounder base, Relay Base Intelligent Sounder base.
	CO ALRM / FIRE SUPR		
	CO SUPR / FIRE ALRM		
	CO SUPR / FIRE SUPR	Latching Non Latching	Supervisory switches can be latching or non-latching.
W- DETECTOR	PHOTO		Wireless photoelectric detectors.
	ACCLIMATE (IDP)		Wireless acclimate photoelectric detector.
	PHOTO-HEAT (SK)		Wireless heat detector.
	HEAT		
W-SUP DET SWITCH	Same as W- Detector	Latching Non Latching	Wireless photoelectric detectors.
SWITCH (cont.)	MANUAL PULL		Use this switch type for manual pull stations. This input is always latched. The switch can clear only when an alarm is reset. This switch type has the highest fire priority; it overrides any other type of fire alarm.
	WATERFLOW	Latching	Use this switch type for monitoring water flow in a sprinkler system. Switch closure will cause a sprinkler alarm. Water flow switches can be programmed as latching or non-latching. You can program a delay of up to 90 seconds to be used with a water flow switch. The delay allows for normal, brief changes in sprinkler system water pressure. The water flow alarm will not activate unless the switch is active for the programmed delay time. If a delay is used, the system begins counting down when the switch closes. If the switch opens (restores) before the timer expires, a water flow alarm is not generated. If the water flow switch remains closed after the timer expires, a water flow alarm will be generated.
		Non Latching	
	FIRE SUPER- VISORY	Latching	Use this switch type for tamper monitoring of sprinklers and other fire protection devices. If a contact closes, a sprinkler supervisory event will be generated. Supervisory switches can be latching or non-latching.
		Non Latching	
FIRE DRILL		System-level, non latching switch. This switch is an alternative way of causing a fire drill. It has the same operation as the fire drill option available from the annunciator. When the switch is activated, a fire drill begins; when the switch is de-activated, the fire drill ends.	

Table 9.5 Programming Options for 6815 Modules

Type Selection	Function	Latching Option	Comments
SWITCH (cont.)	SILENCE		This system-level switch is an alternative way to silence the fire system. It has the same effect as pressing the Silence key.
	RESET		This system-level switch is an alternative way to reset the fire system. It has the same effect as pressing the Reset key.
	P.A.S. ACK		Positive acknowledge switch. This switch must be used in zones programmed as Positive Alarm Sequence (see Edit Zone Properties). If an acknowledge switch closes when an alarm or trouble condition is not already in progress, a trouble will occur. You must use a UL listed normally open, momentary switch type. The switch must be rated at 5V, 100 mA (minimum) and be used with an EOL resistor for supervision.
	ZONE AUX1	Latching	Use these switch types if you want to monitor special zone-level conditions (such as dry contact from a remote power supply).
		Non Latching	
	ZONE AUX2	Latching	
		Non Latching	
	SYSTEM AUX1	Latching	Use these switch types if you want to monitor special system-wide conditions (such as dry contact from a remote power supply).
		Non Latching	
	SYSTEM AUX2	Latching	
		Non Latching	
	DETECTOR		Used to monitor conventional 4-wire detectors, a contact closure will generate a detector alarm event.
	FIRE TAMPER	Latching	Performs identically to a supervisory switch, but will be indicated as a tamper switch on the LCD annunciator.
		Non Latching	
	MANUAL RELEASE		Manual release switch
	INTERLOCK		Interlock release switch input.
	STATUS POINT		
	ECS INPUT	Latching	User also has ECS Event Number 1-8 option for ECS INPUT.
		Non Latching	
	ECS TAMPER	Latching	Only available when an ECS-VCM or ECS-NVCM is installed in the system.
Non Latching			
ECS SUPERVISORY	Latching		
	Non Latching		
CO DETECT SWITCH		CO Detector Switch	
CO SUPERVISORY DETECT SWITCH	Latching	CO Supervisory Detector Switch	
	Non Latching		
NOTIF	OUTPUT PT	Select Group	Output point, a general use notification type. Use for driving standard notification appliances.
	AUX CONST		Use constant power for applications that require a constant auxiliary power source. Power is always present at constant circuits.
	AUX RESET		Use for auxiliary power, resettable applications. See Section Resettable Power for a description of how this option operates.
	AUX DOOR		Use for auxiliary power, door holder applications. For example, if you were using an auxiliary power supply for door holders, you would use this option. See Section Door Holder Power for a description of how this option operates.

Table 9.5 Programming Options for 6815 Modules

Type Selection	Function	Latching Option	Comments
RELAY	OUTPUT PT	Select Group	Output point, a general use relay type. Use for applications requiring a relay, such as fan shutdown, elevator recall, and so on.
	AUX RESET		Use for auxiliary power, resettable applications. See Section Resettable Power for a description of how this option operates.
	AUX DOOR		Use for auxiliary power, door holder applications. For example, if you were using an auxiliary power supply for door holders, you would use this option. See Section Door Holder Power for a description of how this option operates.
Detector	2-Wire Smoke		
W-Gateway			Wireless Gateway
W-SWITCH	Same as SWITCH		
W-Relay	Same as Relay		When a wireless relay is in use, module device count must be limited to 109 modules per loop. This includes wired and wireless modules that are on the same loop. The module address must be within 1-109.

Table 9.5 Programming Options for 6815 Modules

9.5.3 Point Programming For Internal or External Power Module (RPS-1000)

To program for an internal or external power module points:

1. Enter the installer code. The panel will automatically go to the main menu.
2. Select 7 for Panel Programming.
3. Press 4 to enter point menu.
4. Press the up or down arrow key to select the desired module. Refer to Section 8.5 for available choices, then press ENTER.
5. Enter the number of the circuit or point you wish to edit, then press ENTER.
6. Select the type by pressing the up or down arrow key, then press ENTER.
7. Select the function by pressing the up or down arrow key, then press ENTER.
8. If the point supports latching press the up or down arrow key to select latching or non-latching, then press ENTER.
9. Select the zone or group by pressing the up or down arrow key, then press ENTER.
10. If the point supports not being supervised, press the up or down arrow key to select supervised or non-supervised, then press ENTER.
11. Press ENTER to edit point name. See “Editing Text Using the Built-In Programmer” on page 214. Or, Press right arrow key to skip point name edit.
12. Repeat Steps 1 through 11 for all circuits.

Choices	Type Selections	Function Selections for each Type	Comments
Enter Point			
Select Type	UNUSED		
	B NOTIF	NOTIF OUTPUT	User also has Supervised/Unsupervised option
		CONTROL CIRCUIT	
	A NOTIF	Same as B NOTIF	
	AUX_PWR	CONSTANT	Constant auxiliary power.
		AUX RESET	Resettable auxiliary power.
AUX DOOR		Door holder auxiliary power.	
AUX SYNC			

Table 9.6 Menu choices for Internal/External Power Module

Choices	Type Selections	Function Selections for each Type	Comments
Select Type	B SWITCH	MANUAL PULL	Refer to comments column of Table 9.4 for description of these options. Latch or Non-latching feature only appears for WATERFLOW, FIRE SUPERVISORY, FIRE TAMPER, ZONE AUX1, ZONE AUX2, SYSTEM AUX1, SYSTEM AUX2, ECS INPUT, ECS TAMPER, and ECS SUPERVISORY.
		WATERFLOW	
		FIRE SUPERVISORY	
		FIRE TAMPER	
		FIRE DRILL	
		SILENCE	
		RESET	
		P.A.S. ACK	
		ZONE AUX1	
		ZONE AUX2	
		SYSTEM AUX1	
		SYSTEM AUX2	
		MANUAL RELEASE	
	INTERLOCK		
	STATUS POINT		
	ECS INPUT	User also has ECS Event Number 1-8 option for ECS INPUT. Only available when a ECS-VCM or ECS-NVCM is installed in the system.	
	ECS TAMPER		
	ECS SUPERVISORY		
	A SWITCH	Same as B SWITCH	
	B DETECT	2-WIRE SMOKE	Used for Class B, 2-wire detectors.
4-WIRE SMOKE		Used for Class B, 4-wire detectors.	
CO 4-WIRE DET		Used for Class B, 4-wire CO detectors.	
CO 4-WIRE SUP DET		Latching or Non-latching used for Class B, 4-wire CO Supervisory detectors	
A DETECT	2-WIRE SMOKE	Used for Class A, 2-wire detectors.	
	4-WIRE SMOKE	Used for Class A, 4-wire detectors.	
	CO 4-WIRE DET	Used for Class A, 4-wire CO detectors.	
	CO 4-WIRE SUP DET	Latching or Non-latching used for Class A, 4-wire CO Supervisory detectors	
Select Zone/Group			Group or Zone selection will appear depending on the type selected.
Edit Name			See Appendix B

Table 9.6 Menu choices for Internal/External Power Module

9.5.4 Point Programming For 5880/5865 Modules

To program the 5880/5865 module output points:

1. Enter the installer code. The panel will automatically go to the main menu.
2. Select 7 for Panel Programming.
3. Press 4 to enter point menu.
4. Press the up or down arrow key to select the desired module. Refer to Section 8.5 for available choices. Then press ENTER.

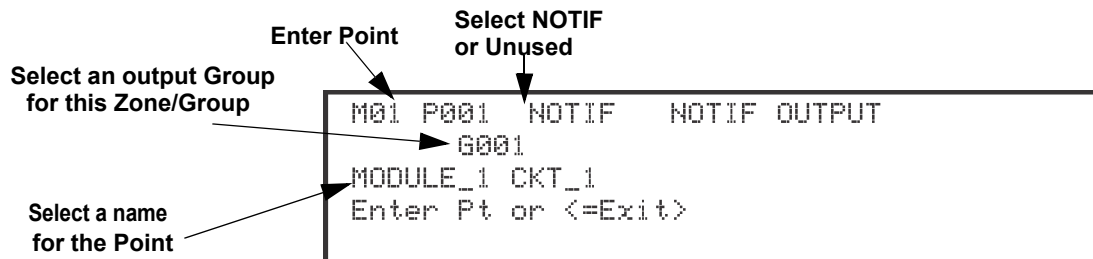

Figure 9.4 Programming Points as Outputs for the 5880 Module

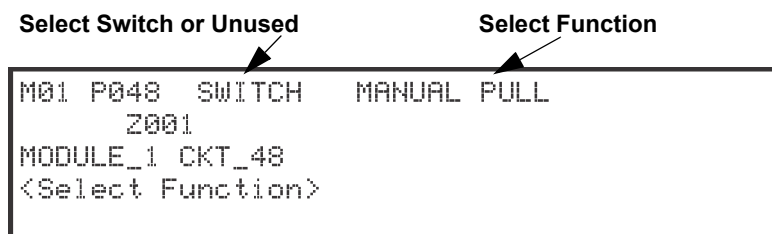

Figure 9.5 Programming Points as Inputs for the 5880 Module

5. Enter the point number, then press ENTER.
6. Press the up or down arrow key to select the type (notification or unused), then press ENTER.
7. Press the up or down arrow key to select the desired group, then press ENTER.
8. Press ENTER to edit point name. See Appendix B. Or, Press right arrow key to skip point name edit.
9. Repeat Steps 1 through 8 for all output points.
10. To use 5880 as Input point, Enter point number 41 - 48. (See Figure 9.5). Then press ENTER.
11. Press the up or down arrow key to select type (switch or unused), then press ENTER.
12. Press the up or down arrow key to select the desired function. (See Figure 9.7), then press ENTER.
13. If the point supports latching press the up or down arrow key to select latching or non-latching, then press ENTER.
14. Press the up or down arrow key to select the desired group/zone, then press ENTER.
15. Edit point name Or Press right arrow key to skip module name edit.
16. Repeat steps 10 through 15 for all input points.

9.5.5 Point Programming for 5496

To program module points:

1. Enter the installer code. The panel will automatically go to the main menu.
2. Select 7 for Panel Programming.
3. Press 4 to enter point menu.
4. Press the up or down arrow key to select the desired module. Refer to Section 8.5 for available choices, then press ENTER.

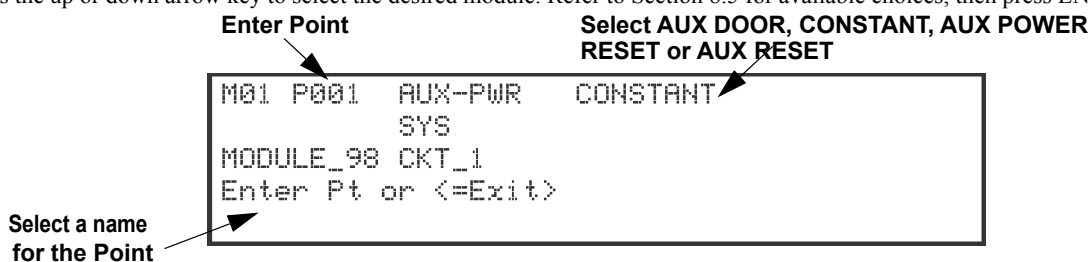

Figure 9.6 Programming Points Screen for the 5496 Module

5. Enter the point number, then press ENTER.
6. Press the up or down arrow key to select the type (See Table 9.6). Then press ENTER.
7. Press ENTER to edit point name. See Appendix B. Or, Press right arrow key to skip point name edit.
8. Repeat Steps 1 through 7 for all points.

9.5.6 Point Programming for ECS-AMP

To program module points:

1. Enter the installer code. The panel will automatically go to the main menu.
2. Select 7 for Panel Programming.
3. Press 4 to enter point menu.

- Press the up or down arrow key to select the desired module. Refer to Section 8.5 for available choices. Then press ENTER.

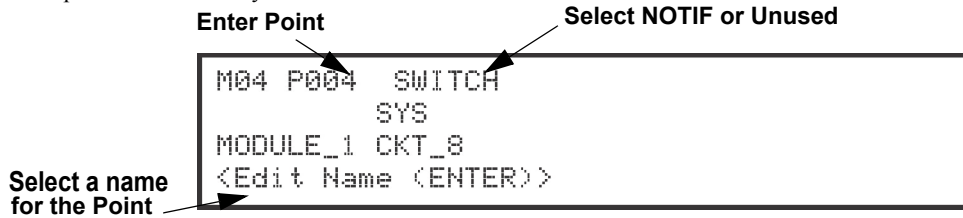

Figure 9.7 Programming Points Screen for the ECS-AMP Module

- Enter the point number, then press ENTER. Points 5-8 on ECS-50W or ECS-125W will not be available unless the ECS-CE4 is installed.
- Press the up or down arrow key to select the type (notification or unused), then press ENTER.
- Press ENTER to edit point name. See Appendix B. Or Press right arrow key to skip point name edit.
- Repeat Steps 1 through 7 for all points.

9.5.7 Point Programming for ECS-VCN, ECS-NVCN or ECS-RVN

To program module points:

- Enter the installer code. The panel will automatically go to the main menu.
- Select 7 for Panel Programming.
- Press 4 to enter point menu.
- Press the up or down arrow key to select the desired module. Refer to Section 8.5 for available choices. Then press ENTER.

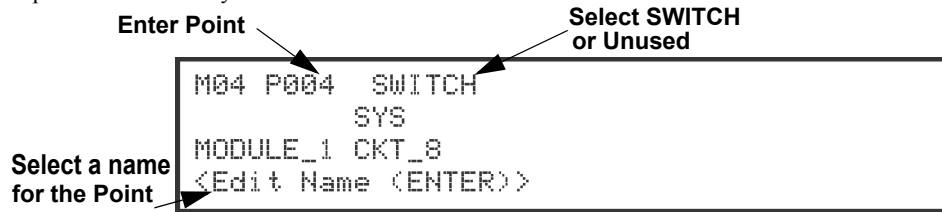

Figure 9.8 Programming Points Screen for the ECS-VCN, ECS-NVCN or ECS-RVN Modules

- Enter the point number. Press ENTER.
- Press the up or down arrow key to select the type (switch or unused). Press ENTER.
- Press the up or down arrow key to select the desired Function (See Table 9.7). Press ENTER.
- Press ENTER to edit point name. See Appendix B or Press right arrow key to skip point name edit.
- Repeat Steps 1 through 8 for all points.

Choices	Type Selections	Function Selections for each Type	Comments
5880 (output)	UNUSED		
	NOTIF (outputs pt 1-40)	NOTIF OUTPUT CONTROL CIRCUIT	
5880 (input 41-48)	SWITCH	MANUAL PULL	Refer to comments column of Table 9.4 for description of these options. Latch or Non-latching feature only appears for WATERFLOW, FIRE SUPERVISORY, FIRE TAMPER, ZONE AUX1, ZONE AUX2, SYSTEM AUX1, SYSTEM AUX2, ECS INPUT, ECS TAMPER, and ECS SUPERVISORY.
		WATERFLOW	
		FIRE SUPERVISORY	
		FIRE TAMPER	
		DETECTOR	
		FIRE DRILL	
		SILENCE	
		RESET	
		P.A.S. ACK	
		ZONE AUX1	
		ZONE AUX2	
		SYSTEM AUX1	
		SYSTEM AUX2	
		MANUAL RELEASE	
		INTERLOCK	
STATUS POINT			
ECS INPUT	User also has ECS Event Number 1-8 option for ECS INPUT, ECS TAMPER, and ECS SUPERVISORY functions in both 5880 and ECS-VCM/ECS-RVM choices. Only available when an ECS-VCM is installed in the system to the ECS-VCM/ECS-RVM choice part.		
ECS TAMPER			
ECS SUPERVISORY			
5496	UNUSED		
	B NOTIF	NOTIF OUTPUT	supervised
		CONTROL CIRCUIT	
	A NOTIF	NOTIF OUTPUT	not supervised
		CONTROL CIRCUIT	
	AUX_PWR	CONSTANT	
		AUX RESET	
AUX DOOR			
AUX SYNC		Can not be supervised	
5865	UNUSED		
	NOTIF	NOTIF OUTPUT CONTROL CIRCUIT	
ECS-AMP	UNUSED		
	NOTIF		

Table 9.7 Choices for Point Programming Modules

Choices	Type Selections	Function Selections for each Type	Comments	
ECS-VCM/ECS-RVM/ECS/NVCM	UNUSED			
	SWITCH	MANUAL PULL	Refer to comments column of Table 9.4 for description of these options. Latch or Non-latching feature only appears for WATERFLOW, FIRE SUPERVISORY, FIRE TAMPER, ZONE AUX1, ZONE AUX2, SYSTEM AUX1, SYSTEM AUX2, ECS INPUT, ECS TAMPER, and ECS SUPERVISORY	
		WATERFLOW		
		FIRE SUPERVISORY		
		FIRE TAMPER		
		FIRE DRILL		
		SILENCE		
		RESET		
		P.A.S. ACK		
		ZONE AUX1		
		ZONE AUX2		
		SYSTEM AUX1		
		SYSTEM AUX2		
		MANUAL RELEASE		
		INTERLOCK		
		STATUS POINT		
		ECS INPUT		User also has ECS Event Number 1-8 option for ECS INPUT.
		ECS TAMPER		Only available when an ECS-VCM or ECS-NVCM is installed in the system to the ECS-VCM or ECS-NVCM or ECS-RVM choice part.
		ECS SUPERVISORY		
VOICE AUX STATUS 1-2				
BACKGROUND MUSIC				
VOICE AUX ECS 1-4				

Table 9.7 Choices for Point Programming Modules

9.6 System Options

This section of the manual explains how to customize software options that affect general operation of the system. This includes such items as: Communication Options, Daytime/Nighttime Sensitivity, Holiday Days, Time Options, Miscellaneous Options, Daylight Saving Options, Edit Banner, and SLC Family. Refer to each individual subsection for complete instructions.

9.6.1 Communication Options

Auto Test Time

To access the Auto Test Time screen:

1. Enter the installer code. The panel will automatically go to the main menu.
2. Select 7 for Panel Programming.
3. Select 5 for System Options.
4. From the next menu, select 1 for Communication Options.
5. Select 1 for Auto Test Time.
6. Enter the hour you desire the control panel to send an automatic test report (or press the up or down arrow key), then press ENTER.
7. Enter the minutes (or press the up or down arrow key), then press ENTER.
8. Select AM or PM by pressing the up or down arrow key, then press ENTER.
9. Select Report Time Interval by pressing the up or down arrow key, then press ENTER. Time Interval selections are 24hr, 12hr, 6hr and 4 hr.



NOTE: AM and PM are only available if the panel "Clock Options" are set for AMPM mode. Otherwise the clock is in military time and AMPM is not selectable

Phone Lines

To access the phone lines screen:

1. Enter the installer code. The panel will automatically go to the main menu.
2. Select 7 for Panel Programming.
3. Select 5 for System Options.
4. From the next menu, select 1 for Communication Options.

5. Select 2 for the phone Lines.
6. Select Phone Line to be edited (1 or 2) by pressing the up or down arrow key, then press ENTER.

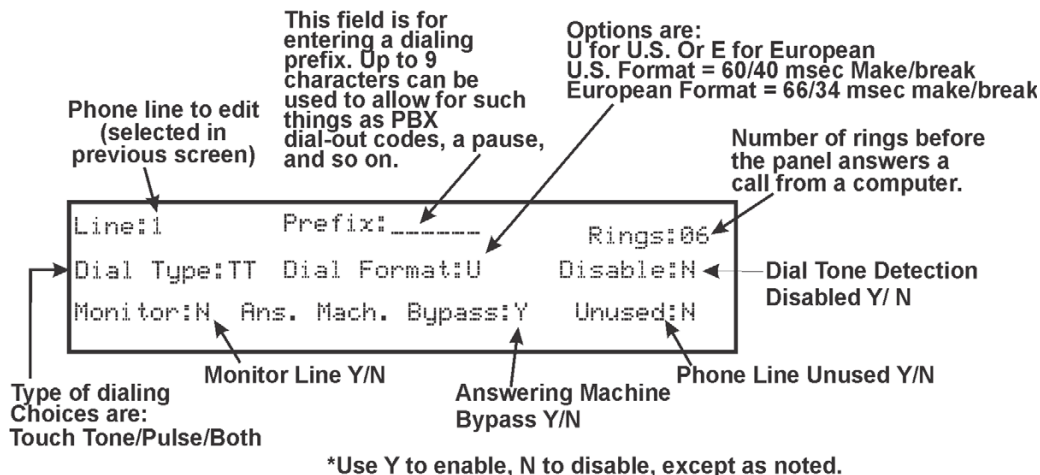

Figure 9.9 Phone Lines Editing Screen

■ Dialing Prefix

Enter up to 9 characters to be used for such things as PBX dial-out codes, a pause, and so on. The following special characters are available:

#	Pound (or number) key on the telephone
*	Star key on the telephone
,	Comma (character for 2-second pause)

Use the number buttons on the annunciator or the up- and down-arrow keys to select special characters. Special characters begin displaying after “9”.

7. Enter a dialing prefix (if needed), then press ENTER. Or Press the right arrow to bypass the dialing prefix option.

■ Number of Answer Rings

This option is used in conjunction with HFSS Honeywell Fire Software Suite. Use this option to determine the number of rings before the panel answers a call from the computer. Range is 00-15 rings. This option is factory-programmed as 06 rings, which should be compatible for most installations where the answering machine bypass feature is used. You may need to adjust it depending on the installation’s telephone system.

The selection made here must match the programming for this option in the Communication Configuration dialog box of HFSS.

8. Enter the desired number of answer rings, then press ENTER.

■ Dial Option (TouchTone or Pulse, or TT/PL)

9. Press the up or down arrow key to select the dial option, then press ENTER.

Dial Option	Description
PULSE	If this option is selected, only pulse dialing will be used for this phone line.
TT	TouchTone dialing. If this option is selected, only TouchTone dialing will be used for this phone line.
TT/PL	TouchTone alternating with pulse. If this option is selected, the communicator will first attempt to use TouchTone. It will switch to pulse if TouchTone is not successful on the first attempt. It will continue to alternate between TT and pulse for additional attempts.

■ Dial Format

10. Press the up or down arrow key to select the pulse ratio for rotary dialing option, then press ENTER.

Options are:

U	U.S. standard format. Uses the 60 msec / 40 msec make/break ratio.
E	European format. Uses the 66 msec / 34 msec make/break ratio.

■ Dial Tone Detection Disabled

11. Select Y (do disable) or N (don’t disable) by pressing the up or down arrow key, then press ENTER.

■ Monitor Line

Enable the line monitor for each phone line that will be used. See “Phone Lines Editing Screen” on page 145 for location of this field on the phone lines screen. When the phone line monitor has been enabled for a phone line, a trouble condition will occur if the line is not connected. If a phone line will not be used, it must be disabled.

12. Select Y (monitor line) or N (don't monitor line) by pressing the up or down arrow key, then press ENTER.

■ Answering Machine Bypass

This option is used in conjunction with HFSS Honeywell Fire Software Suite. This feature ensures that an answering machine will not interfere with communication between the panel and the computer. If an answering machine is used at the panel site, enable this feature; if an answering machine is not used, disable the feature.

This option is factory-programmed as No (disabled).

The selection made here must match the programming for this option in the Communication Configuration dialog box of HFSS.

13. Select Y (answering machine bypass enabled) or N (answering machine bypass disabled) by pressing the up or down arrow key, then press ENTER.

■ Phone Line Unused

This option is used so that you can set unused phones lines to “Yes”, so no auto-test will be sent through that line.

This option is factory programmed as No.

14. Select Y or N by pressing the up or down arrow key, then press ENTER.

Edit Ethernet

1. Enter the installer code. The panel will automatically go to the main menu.
2. Select 7 for Panel Programming.
3. Select 5 for System Options.
4. From the next menu, select 1 for Communication Options.
5. Select 3 for Edit Ethernet.

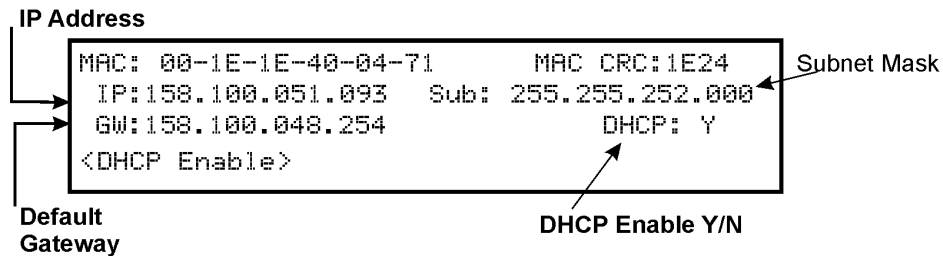

Figure 9.10 Edit Ethernet Message

AlarmNet Timers

1. Enter the installer code. The panel will automatically go to the main menu.
2. Select 7 for Panel Programming.
3. Select 5 for System Options.
4. From the next menu, select 1 for Communication Options.
5. Select 4 for AlarmNet Timers.
6. The available options for AlarmNet Timers are as follows: *default
 - Ethernet: None, 75 seconds, 90 seconds, 3 minutes, *5 minutes, 1 hour, 24 hours,30 days.
 - Cellular: None, *24 hours, 30 days
 - Old Alarm: None, 10 minutes, 15 Minutes,*30 Minutes, 1 Hour, 2 Hours, 4 Hours, 6 Hours, 12 Hours, 24 Hours. (Sets how long an undeliverable alarm is retried for delivery to the central station. If the message is not validated, it is retried until the old alarm time is reached or the message is validated).

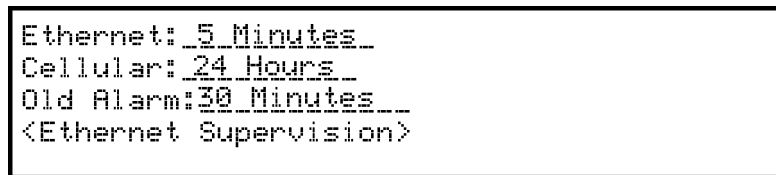

Figure 9.11 AlarmNet Timers

Phone Line Gains

1. Enter the installer code. The panel will automatically go to the main menu.
2. Select 7 for Panel Programming.

3. Select 5 for System Options.
4. From the next menu, select 1 for Communication Options.
5. Select 5 for Phone Line Gains
6. The available options: *default
 - Dialing Gain:
 - Low = 9 DB Attenuation
 - Normal = 6 DB Attenuation
 - *High = 3 DB Attenuation
 - Reporting Gain:
 - *Low = 9 DB Attenuation
 - Normal = 6 DB Attenuation
 - High = 3 DB Attenuation

9.6.2 Daytime/Nighttime Sensitivity

If you need to change the time that sensitivity levels take effect (that is, the time that “Day” and “Night” begin), follow these steps.

1. Enter the installer code. The panel will automatically go to the main menu.
2. Select 7 for Panel Programming.
3. Select 5 for System Options.
4. Select 2 for Daytime/Nighttime Sensitivity.

A screen similar to the one shown in Figure 9.12 will display.

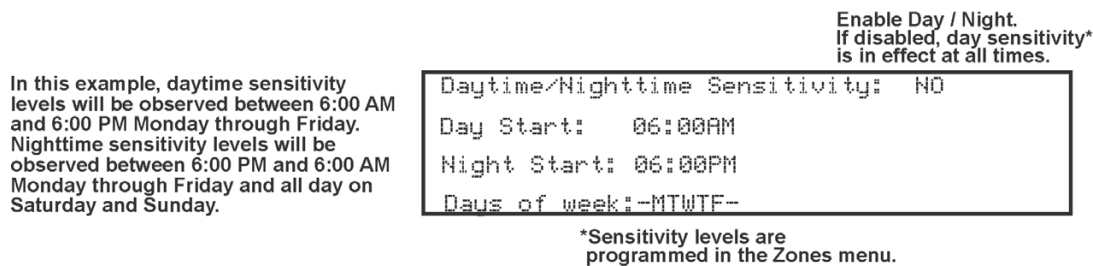

Figure 9.12 Changing Day/Night Sensitivity Time

9.6.3 Holiday Days

Up to 18 dates can be designated as holidays. When day/night sensitivity is enabled, all photoelectric smoke detectors in the system will use night sensitivity for the entire day on days designated as holidays.

To add or change a holiday, follow these steps:

1. Enter the installer code. The panel will automatically go to the main menu.
2. Select 7 for Panel Programming.
3. Select 5 for System Options.
4. Select 3 for Holiday Days. A screen similar to that shown in Figure 9.13 will display.
5. Edit the holiday schedules you wish to change or add holidays as needed in the programmable holiday locations.

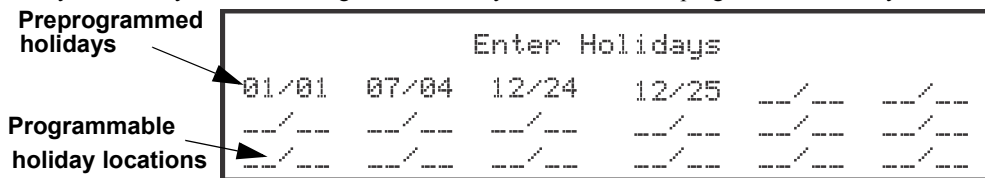

Figure 9.13 Edit Holidays Screen

6. Enter the month of the holiday, then press ENTER. Enter the day of the month for the holiday, then press ENTER.
7. Repeat steps 6 for any remaining holidays you wish to program.

9.6.4 Time Options

Through this programming option you can set the water flow delay time, alarm verification time, AC report delay, AC-Frequency, Auto-Resound, and Clock Format.

Water Flow Delay

You can program a delay of 0-90 seconds (zero means no delay) to be used in conjunction with a water flow switch. The delay is system-wide. All water flow switches on the system will use the same delay period.

To access the screen for programming water flow delay, follow these steps:

1. Enter the installer code. The panel will automatically go to the main menu.
2. Select 7 for Panel Programming.
3. Select 5 for System Options.
4. Select 4 for Time Options.

A screen similar to the one shown in Figure 9.14 will display.

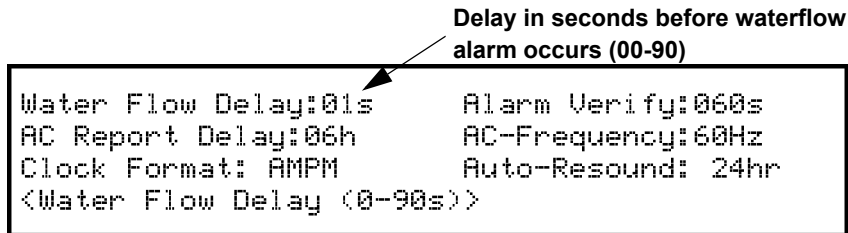

Figure 9.14 Water Flow Delay Programming Screen

5. Enter the number of seconds (0 to 90) to delay a water flow switch alarm, then press ENTER.

Alarm Verify

You can set the alarm verification time from 60 to 250 seconds (default is 60 seconds).

To set the alarm verification:

6. Enter the desired number of seconds for the alarm verification time.
7. Press right arrow key or ENTER to make your selection and move to the next programming option.

AC Report Delay



NOTE: You must select 1-3 hours in UL central station installations and UL remote signaling installations.

You can adjust the number of hours before a low AC report will be sent to the central station.

To program low AC report delay, follow these steps continued from step 7.

8. Enter the number of hours (0-30) before a low AC report will be sent to the central station, then press ENTER.

Change AC Line Frequency

The panel's AC line frequency is selectable for 50, 60 Hz, or Internal. AC Frequency feature dictates how the control panel will calculate time based on the AC line frequency used in the installation site. The "Internal" option can be used in areas where the AC line frequency is not dependable and you want the panel to calculate time from the internal crystal. The internal crystal is not as accurate as the AC power source and internal 60 Hz or 50 Hz should normally be selected. The panel defaults to the 60 Hz selection.

To change the AC line frequency:

9. Select 50Hz, 60Hz or Intl, by pressing the up or down arrow key, then press ENTER.

Clock Format (AM/PM or Military)

To change the system clock display format:

10. Select AMPM (for AM/PM display format) or MIL (for military or 24 hr display format) by pressing the up or down arrow key, then press ENTER.

Auto-Resound (4 or 24 hours)

The system resound time period can be modified from the default value 24 hours to 4 hours. This setting adjusts when the FACP will automatically resound events after being silenced. Set this option to 4 hours when using SWIFT devices

9.6.5 Miscellaneous Options

Through this programming option you can do strobe synchronization during silence, and auto display event.

To edit Miscellaneous options:

1. Enter the installer code. The panel will automatically go to the main menu.
2. Select 7 for Panel Programming.
3. Select 5 for System Options.
4. Select 5 for Miscellaneous Options

Strobes Active when Silenced

When “SYNC Strobe:” is selected as Y (Yes), the strobes will continue to flash when the system is silenced and will stop flashing when the system is reset.



NOTE: The “SYNC Strobe:” only functions with outputs that use a synchronized output pattern.

5. Press the up or down arrow key to toggle this selection between Y (Yes) or N (No).
6. Press right arrow key or ENTER to make your selection and move to the next programming option.

Auto Display Events

When this feature is programmed Y (Yes), the highest priority event of the system in control will automatically display on the control panel and remote annunciators after there has been no activity on any system touch pad for two minutes.

7. Press the up or down arrow key to toggle this selection between Y (Yes) or N (No).
8. Press right arrow key or ENTER to make your selection and move to the next programming option.

9.6.6 Daylight Saving Options

To edit Daylight Saving Time:

1. Enter the installer code. The panel will automatically go to the main menu.
2. Select 7 for Panel Programming.
3. Select 5 for System Options.
4. Select 6 for Daylight Saving Option.

Automatic Daylight Saving Adjustment

The control panel has an automatic DST (Daylight Saving Time) adjustment feature. If this feature is not enabled (set to *No*), the Daylight Saving Time change is not made to the system clock.

To enable or disable DST adjustment continue programming:

5. Select Y (enabled) or N (disabled) by pressing the up or down arrow key, then press ENTER.

Daylight Saving Time Start and End

This option lets you to adjust the week and month Daylight Saving Time (DST) starts and ends. For this feature to work, you must enable (set to *Yes*) the Automatic Daylight Savings Adjustment option under Daylight Savings Options. The default values for the DST Start and End are:

DST Start: The second Sunday in March

DST End: The first Sunday in November

To set the start and end for Daylight Saving Time:

6. Press the up or down arrow key to select the week (1st, 2nd, etc.) Daylight Saving Time starts, then press ENTER to make your selection and move to the month setting.
7. Press the up or down arrow key to select the month (January – December) Daylight Saving Time starts, then press ENTER to make your selection and move to the DST End option.
8. Press the up or down arrow key to select the week (1st, 2nd, etc.) Daylight Saving Time ends, then press ENTER to make your selection and move to the month setting.
9. Press the up or down arrow key to select the month (January – December) Daylight Saving Time ends, then press ENTER.

9.6.7 Edit Banner

The banner is the message that displays on the panel LCD when the system is normal; that is, when no alarms or troubles exist and the system menus are not in use. A custom banner of up to 40 characters can be created. This will automatically be centered when shown.

If a custom message is not created, the system will use the internal banner. You cannot change the internal banner.

To customize the banner display message:

1. Enter the installer code. The panel will automatically go to the main menu.
2. Select 7 for Panel Programming.
3. Select 5 for System Options.
4. Select 7 for Edit Banner. (See Appendix B for instructions on how to edit the banner)
5. Select each letter by pressing the up or down arrow key to change modes and using the number keys to select characters, then press right arrow key to move to the next character.
6. When done, press ENTER to save the custom banner.

9.6.8 SLC Family

The IFP-2100/ECS supports SD series, SK Series or IDP (Intelligent Device Protocol) series SLC devices. You must configure the IFP-2100/ECS to accept the family of the devices you are installing.



NOTE: You cannot mix SD, SK and IDP series SLC devices on the same system.

1. Enter the installer code. The panel will automatically go to the main menu.
2. Select 7 for Program Menu.
3. Select 5 for System Options.
4. Press 8 to edit SLC Family.
5. Press UP arrow to select the desired SLC family.
6. Press ENTER to accept the displayed SLC family.

■ **When changing SLC type the following message will appear:**

```

Changing the SLC family will set all
SLC points to UNUSED

←Back                               [Enter] to Accept

```

Figure 9.15 SLC family change



NOTE: Message appears when changing SLC family from IDP or SK to SD: "Changing to this SLC family will remove all external 6815s"

NOTE: Message appears when changing from SD to IDP or SK "SLC family will remove all 5815XLs on the system"

9.7 JumpStart® AutoProgramming

IMPORTANT!

JumpStart AutoProgramming is used to auto learn the system hardware after devices have been added or removed from the system. Hardware devices which remain the same between repeat JumpStarts will retain any customized text or options associated with the device. It is best to carefully consider the network ID setting for each panel before the first JumpStart AutoProgramming is performed. Once this is done the panel must be defaulted back to factory defaults if the network ID settings need to change.

To run JumpStart:

1. Enter the installer code. The panel will automatically go to the main menu.
2. Select 7 for Panel Programming.
3. Select 6 for JumpStart®.
4. Press ENTER to accept the warning screen.
5. Follow the remaining on screen instructions.
6. Press ENTER to confirm. See Section 8.1.3.

9.8 Restore Defaults

This option allows you to restore the panel back to factory defaults. All programming will be lost.

1. Enter the installer code. The panel will automatically go to the main menu.
2. Select 7 for Panel Programming.
3. Select 7 for Restore Defaults.
4. Press the up or down arrow key to select YES or NO from the warning screen. Then press ENTER.

9.9 Voice Options

Through this programming menu you can modify the messages programmed into an VCM. You can also modify other voice settings.

9.9.1 VCM Maintenance

The VCM Maintenance menu is used to program custom messages into the VCM. Messages can be recorded locally using the microphone.

1. Select 7 for Panel Programming.
2. Select 8 for Voice Options.
3. Select 1 for VCM Maintenance.

9.9.2 Voice Settings

1. Select 7 for Panel Programming.
2. Select 8 for Voice Options.
3. Select 2 for Voice Settings.

Enable Dual Channel System

This option allows you to select whether dual channel is enabled in the system. For dual channel capabilities the system must only contain dual channel voice hardware.

1. Press the up or down arrow key to select YES or NO for enabling the system as dual channel. Then press ENTER.

Section 10: System Operation

Operation of the control panel is user friendly. Menu guide you step-by-step through operations. This section of the manual is an overview of the operation menus. Please read this entire section carefully before operating the panel.



NOTE: See Section 6.2.5 for information on how to modify user access code profiles.

10.1 Default User and Installer Codes

Installer Code: Factory-programmed as 123456.

Multi-site Installer Code: Factory-programmed as 654321.

10.2 Annunciator Description

Figure 10.1 shows the annunciator that is part of the control panel board assembly.

Five LEDs indicate system status.

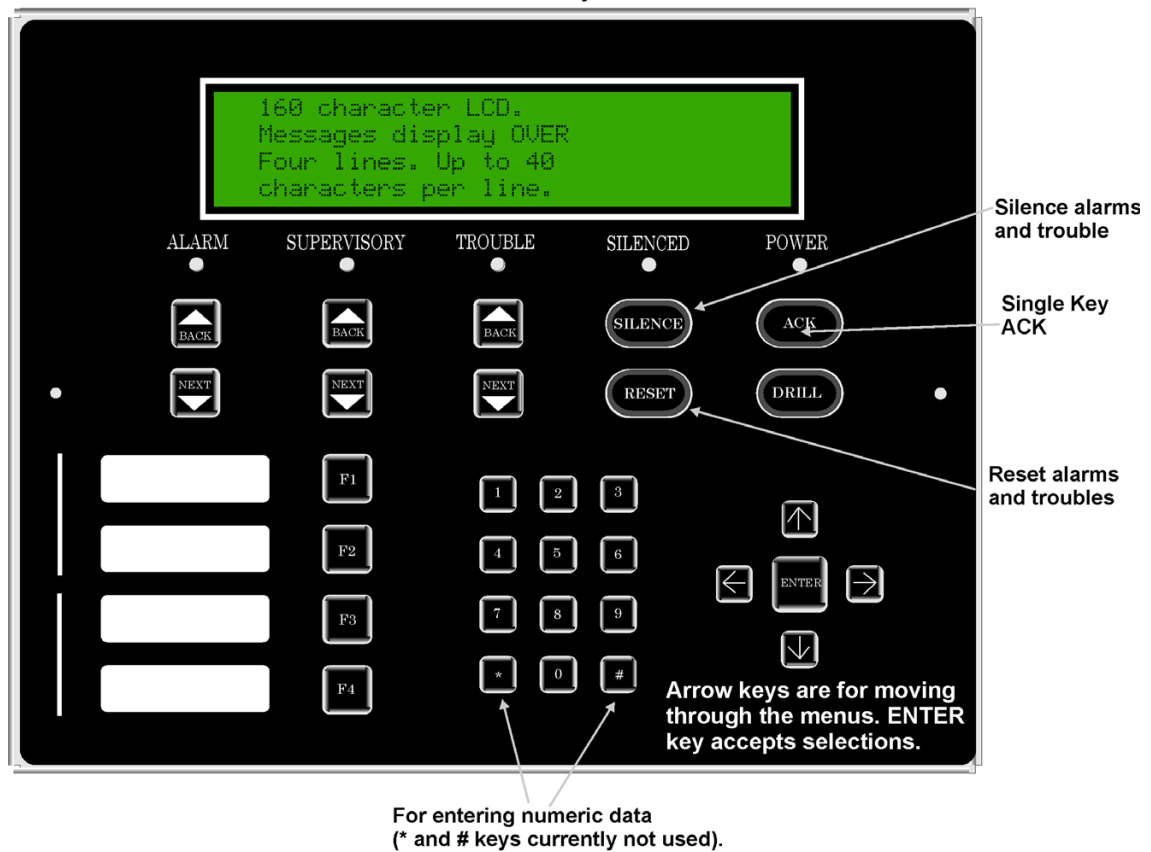

Figure 10.1 Control Panel Annunciator

10.2.1 LCD Display

The control panel LCD displays system messages, annunciates alarms, supervisories and troubles, provides status information, and prompts for input. These messages can be up to 160 characters, displaying over four lines of 40 characters each. Annunciator keys beep when they are pressed.

10.2.2 Banner

The banner is the message that displays on the control panel when the system is in normal mode (no alarm or trouble condition exists and menus are not in use). A customize message can be created that will display instead of the internal (default) message. See Section 9.7 for information on editing the banner.

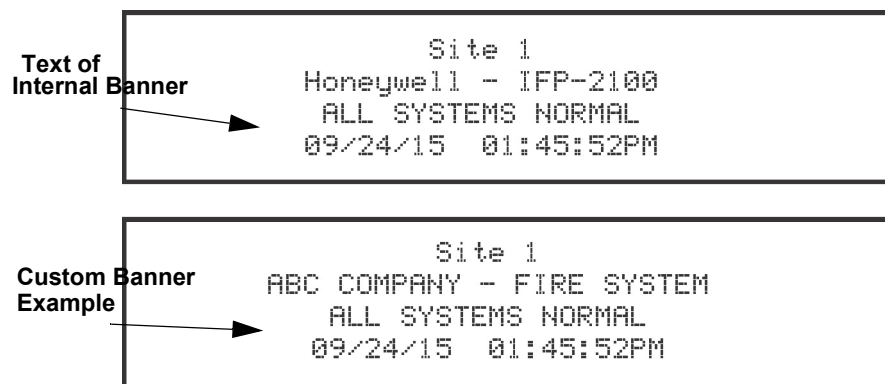

Figure 10.2 Banner Display Examples

Single Key Acknowledge

This feature allows the user to press the ACK and display the oldest un-acknowledged event in the system. Pressing ACK again will acknowledge the event, then display the next oldest un-acknowledged event without pressing the arrow keys.

10.3 Menu System

The control panel is easy to operate from the Main Menu. To view the Main Menu press the ENTER or right arrow key on the control panel or remote annunciator. The Main Menu will appear as shown in Section 10.3.1. Select the desired option. You will be prompted for an access code if required.

The control panel supports up to 20 access codes. The profile for each access code (or user) can be modified through the network programming option (see Section 6.2.5 for access code programming).

10.3.1 Main Menu Overview

The chart below is a brief overview of the Main Menu. These options are described in greater detail throughout this section of the manual.

Main Menu Options	Description
1- System Tests	Access to Fire Drill, Indicator Test, Walk Tests, Communicator Test, Clear History Buffer, Manual AlarmNet Registration and Manual Communicator Reset.
2- Point Functions	Enable/disable points, Point Status, SLC Single Device Locator, SLC Multiple Device Locator, and I/O Point Control.
3- Event History	Display event history on the LCD. See Section 10.4.3 for more information.
4- Set Time & Date	Set time and date for the system.
5- Network Diagnostics	Ping Panel, Data Network Status and Voice Network Status.
6- Network Programming	Access Learn Network, Edit Network Names, Edit Panel ID, Computer Access, Access Codes, Communicator Options, Voice Options, Sync Network Options.
7- Panel Programming	Brings up a set of menus for programming the panel. These options are described in detail in "Programming" on page 128.
8- System Information	Menus to view information about the panel such as model, ID, serial number, revision, send or receive firmware updates and feature registration activation.

10.3.2 Using the Menus

To move through the menus:	Use the up or down arrow key to move through the options in a menu.
To select an option:	Enter the number of the option, OR press ENTER if the option has the = symbol next to it.
Exit Menu	Left arrow

10.4 Basic Operation

10.4.1 Setting Time and Date

1. Select 4 for Set Date & Time.
2. Make changes in the fields on the screen. Use right arrow to move through the fields. Use the up or down arrow key to select options in the fields.
3. When the date and time are correct, press ENTER.

10.4.2 Disable / Enable a Point

1. Select 2 for Point Functions.
2. Select 1 for Disable/Enable Point.

Disable / Enable NACs by Template

1. Press 1 for Disable NACs by Template, or press 2 to Enable NACs by Template.
2. Use the up or down arrow key to move through the list of templates. Press ENTER to select the current template.

Disable / Enable NACs by Group

1. Press 3 to Disable NACs by Group, or press 4 to Enable NACs by Group.
2. Use the up or down arrow key to move through the list of groups. Press ENTER to select the group highlighted.

Disable / Enable Zone Points

1. Press 5 to Disable Zone Points, press 6 to Enable Zone Points.
2. Use the up or down arrow key to move through the list of zones. Press ENTER to select the zone highlighted.

Disable / Enable Point

1. Press 7 to Disable /Enable Point.
2. Choose Module.
3. Use the up or down arrow key to choose point and press ENTER.
4. Press right arrow to disable or enable point.

Inhibit Output Group

Inhibiting an output group prevents the group from being utilized by system mapping. While inhibited no event in the system can activate the output group.

1. Press 8 to inhibit output group.
2. Use the up or down arrow key to select the group to be inhibited.
3. Press right arrow to inhibit the group.
4. Press right arrow again to enable the group.

10.4.3 View Event History

Use the View Event History feature to display events on LCD. From the Main Menu, press 3 to select Event History. Events will begin displaying with most recent events first.

The panel can store up to 1000 events. When it reaches its 1000-event capacity, it will delete the oldest events to make room for the new events as they occur. In networked setups, each panel stores up to 1000 of its own events. When viewing Event History in the panel, the newest 500 events from every panel in the site will be displayed. When using HFSS Honeywell Fire Software Suite, all 1000 events from every panel in the network will be uploaded.

On multi-site displays, pressing ENTER or right arrow brings you directly into View Event History and allows you to view the Event History from every panel in each of the sites that the multi-site display is assigned to.

To clear the event history

From the Installer menu select 1 for System Tests. From the test menu select 6 Clear History Buffer. In network systems, this clears the History Buffer of all panels in the site.

10.4.4 Conduct a Fire Drill

This system test initiates a Fire Drill alarm and activates Fire Drill mapping for 10 minutes or until a user manually exits the fire drill.

1. From the Main Menu, press 1 for System Tests.
2. Press 1 for Fire Drill. You will be prompted to press ENTER.
3. The drill will begin immediately after you press ENTER.

- Press any key to end the drill. (If you do not press any key to end the fire drill manually, it will time out automatically after ten minutes.)

If a fire drill switch has been installed, activating the switch will begin the drill; deactivating the switch will end the drill.

10.4.5 Conduct an Indicator Test

The indicator test checks the annunciator LEDs, PZT, and LCD display.

- From the Main Menu, press 1 for System Tests.
- Press 2 for Indicator Test. The system turns on each LED several times, beeping the PZT as it does so. At the same time it scrolls each available character across the LCD. A problem is indicated if any of the following occurs:
 - An LED does not turn on.
 - You do not hear a beep.
 - All four lines of the LCD are not full.

This test will run for approximately 15 minutes or until the user manually exits. You can press any key to end manually while the test is still in progress. When the test ends, you will be returned to the <Test Menu>.

10.4.6 Conduct a Walk Test

Walk Test is a feature which allows one person to test the fire alarm system. The Walk Test will run for 4 hours or until the user manually exits. If an alarm or pre-alarm condition is occurring in the system, you will not be able to enter the walk test. A walk test may only be initiated if the test is enabled in the user profile.

- From the Main Menu, press 1 for System Tests.

IMPORTANT

If any alarm verification zones are being used, the user will be asked if they wish to disable alarm verification during walk test. This occurs for either walk test option.

- Select 3 for Walk Test-No Report. The LCD will display “WALK TEST STOPPED” on Line 1 and “ENTER = start test” on Line 3. Enter the time period you wish the NAC circuit to be active for each alarm (06 to 180 second), if you select this option, central station reporting will be disabled while the test is in progress.

Select 4 for Walk Test-with Report. The LCD will display “WALK TEST STOPPED” on Line 1 and “ENTER = start test” on Line 3. Enter the time period you wish the NAC circuit to be active for each alarm (06 to 180 seconds) If you select this option, central station reporting will occur as normal during the walk test.

The panel generates a TEST report to the central station when the walk test begins. During a walk test, the panel’s normal fire alarm function is completely disabled, placing the panel in a local trouble condition. All zones respond as 1-Count zones (respond when a single detector is in alarm) during a walk test. Each alarm initiated during the walk test will be reported and stored in the event history buffer.

- Press ENTER to end the walk test. The system will reset. The panel will send a “TEST RESTORE” report to the central station.



NOTE: The panel does not do a full 30 second reset on resettable power outputs. As soon as the device is back to normal, the panel is ready to go to the next device.

10.4.7 Conduct a Communicator Test

- From the Main Menu, press 1 for System Tests.
- Select 5 for Communicator Test. The screen will display “Manual communicator test started”. When the test is completed, you will be returned to the <Test Menu>. A manual communicator test requires that at least one daily test in the network be enabled in communicator programming.
- The Manual communicator test will be communicated out both Phone Lines and Ethernet/Cellular paths if they are all programmed. Each manual communicator test will alternate between one of the Phone Line paths and one of the AlarmNet paths.

10.4.8 Manual AlarmNet Registration

- From the Main Menu, press 1 for System Tests.
- Select 8 for Register AlarmNet. The screen will display and ask for confirmation. Feedback will be given if the command was sent or not.

10.4.9 Silence Alarms or Troubles

Press SILENCE to turn off silenceable outputs and annunciator PZTs. If an external silence switch has been installed, activating the switch will silence alarms or troubles. If you are already using system menus when you press SILENCE, you will not need to enter your code.



NOTE: Alarm and trouble signals that have been silenced, but the detector remains un-restored, will un-silence every 4 or 24 hours depending on user selection (see section Auto-Resound (4 or 24 hours) until the detector is restored.

NOTE: Multi-Site displays do not allow for silencing multiple sites. Pressing SILENCE will only locally silence the PZT built into the annunciator. To silence a site, enter a multi-site access password, select a site, and then press SILENCE.

NOTE: For ECS systems, pressing silence at an LOC will only silence the System in Control. See Section 10.5.1

10.4.10 Reset Alarms

Press RESET to perform a control panel reset. If an external reset switch has been installed, activating the switch will reset fire alarms.



NOTE: Multi-Site displays do not allow for resetting multiple sites. To reset a site, enter a multi-site access password, select a site, and then press RESET.

NOTE: For ECS systems, pressing reset at an LOC will prompt the user for which system they desire to reset. See Section 10.5.1

Reset Communicator

This options allows the user to Reset the communicator. The LCD will display:

“Resetting Communicator... Please Wait“

You will be returned to the Main Menu when the reset is complete.

The communicator is not allowed to be reset when alarms or supervisories are active. Communicator reset is not allowed if any of the following are active:

- Fire Alarm
- Fire Supervisory
- Fire Pre-Alarm
- CO Alarm
- CO Supervisory
- ECS Alarm
- ECS Supervisory

10.4.11 Check Detector Sensitivity Through Point Status

The control panel constantly monitors smoke detectors to ensure that sensitivity levels are in compliance with NFPA 72. Detectors are sampled every three hours.

If sensitivity for a detector is not in compliance, the panel goes into trouble, generating a Calibration Trouble condition. A detector enters a Calibration Maintenance state to indicate that it is approaching an out of compliance condition (but is currently still in compliance).

When a Calibration Trouble condition occurs, the central station receives a detector trouble report (“373” + Zone # for Contact ID format; “FT” + Zone # in SIA format).

To check sensitivity for an individual detector, follow the steps below.

1. From the Main Menu, press 2 for Point Functions.
2. Press 2 for Point Status.
3. Select the module where the point you want to check is located.
4. Enter the number of the point you want to check and press ENTER.

5. A screen similar to those shown in “Checking Detector Sensitivity Compliance” on page 157 will display.

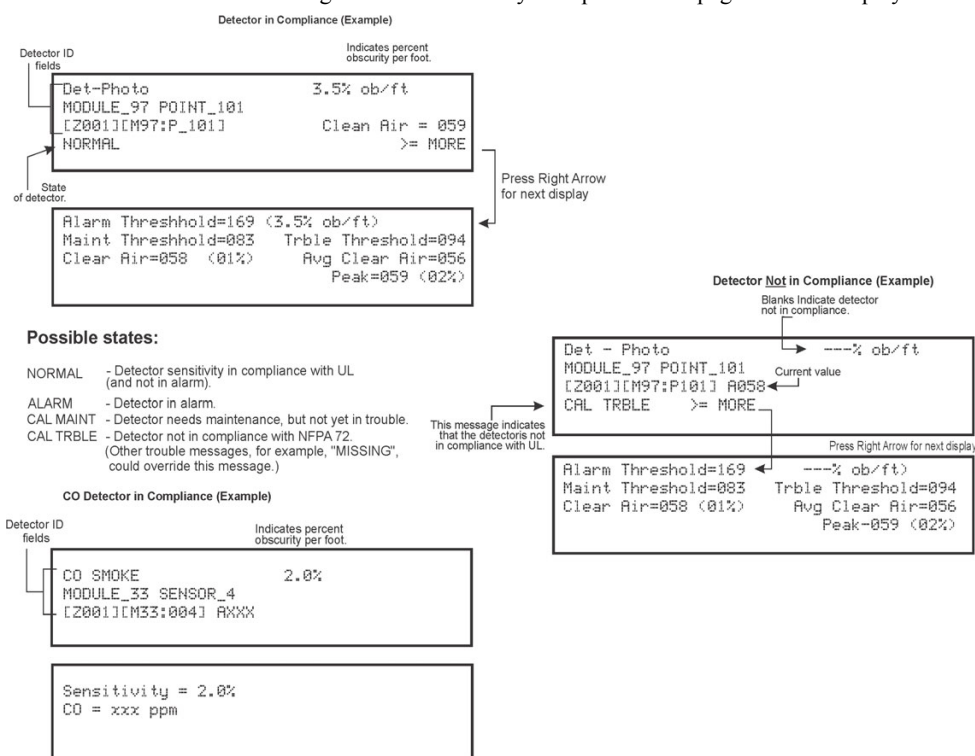

Figure 10.3 Checking Detector Sensitivity Compliance

You can print detector status by uploading the detector status to and printing from HFSS Honeywell Fire Software Suite.

10.4.12 View Status of a Point

- From the Main Menu, press 2 for Point Status.
- From the list that displays, press ENTER to select the module where this point is located. The screen that displays will show you if the point has a trouble and will provide sensitivity compliance information. (See Section 10.4.11 for complete information about detector sensitivity compliance.)

10.4.13 View Alarms or Troubles

When the system is in alarm or trouble, you can press down arrow to view the location of an alarm or trouble.

10.4.14 System Information

- From the Main Menu, press 8 to access the System Information menu.

■ About Panel

Press 1 to access About Panel to view the panel model, serial number and system version number and date.

■ Send/Receive firmware updates

The IFP-2100/ECS or RFP-2100 has the ability to be updated in the field. The latest IFP-2100/ECS or RFP-2100 Firmware Update Utility can be downloaded from the Farenhyt Web Site. Once a panel has been updated using the Firmware Update Utility, you can use Send/Receive firmware updates to propagate the firmware to the other panels in the network.

- Press 2 to send a firmware update or press 3 to receive a firmware update from the System Information menu. Available panels are listed in the menu.
- Use the up or down arrow key to select a panel to send/receive an update to/from. Press ENTER to start the update process.

■ Feature Activation

This menu is used to activate/register additional features.

- Press 4 from the System Information menu. This will bring up the Feature Activation menu.
- Press 1 to enter a six digit activation code or press 2 to review features already activated in this panel.

■ Ethernet Info

1. Press 5 from the System Information menu for Ethernet Information.

```

>Ethernet Info>
MAC Address 00-D0-2D-20-68-94 MAC CRC0000
IP:000.000.000.000 Sub: 000.000.000.000
GW:000.000.000.000 DHCP: Y

```

■ AlarmNet Info

1. Press 6 from the System Information menu for AlarmNet Info
2. Cell Strength: 0 to 100%
3. Status: Registered/Not Registered

■ AlarmNet Temporary PIN

1. Press 7 from the System Information menu for AlarmNet Temporary PIN. This is used in case the FACP is replaced on the CCP.

10.5 Event Priority

This section goes over how event activations are handled by the control panel with regards to priority.

10.5.1 System Control

The IFP-2100/ECS control panel integrates both a fire and emergency system into one. When events are active from both systems the control panel makes intelligent decisions to determine which system should be controlling outputs. This is called System Control. This manual will refer to the fire or emergency systems having System Control, this means that the system has an active alarm or supervisory event that has a higher event priority than an active alarm or supervisory event from the other system. For this consideration, the control panel looks at the highest priority event active on each system. When both systems are active, the system with control will activate System Override. System Override is activated on the lower priority, non-System Control panel system (fire or emergency system.)

10.5.2 System Override

System Override temporarily disengages output group activations from the system being overridden. This is done to not provide conflicting messages and signaling and help with reducing confusion of the building occupants.

When output groups are supposed to be active but are not because System Control has activated System Override, they are re-activated every 30 seconds for 2-3 seconds to indicate to the building occupants that there is still an event active. This will only occur when the system with System Control is not using the output group. The System Override option is programmable for non-voice output groups on a per output group basis through the panel output group programming menus and in HFSS Honeywell Fire Software Suite. In these places the option is called Allow System Override and defaults to YES. It is also possible to not reactivate the output groups every 30 seconds when System Override is active on a per system basis. This option is programmable in HFSS.

There are times when you would not want to allow System Override for an output group. For example: fire is programmed to an elevator relay to bring the elevator to the bottom floor for fire only. If fire and ECS are active with ECS being the higher priority event, you still need the elevator to move to the bottom floor and only audible and visual notification appliances must be overridden. In this case, the output group assigned to the relay would be set to NO on the Allow System Override setting. See Section to edit group properties.

10.5.3 Event Priority

Each event type (see Table 10.1) has a priority level assigned to it. When more than one event type is active, the panel uses the Event Priority Table to determine which event mapping to use to control output groups. The Event Priority Table can be modified using HFSS Honeywell Fire Software Suite. It is strongly recommended that before each installation a risk analysis is done by the stake holders (property owners, AHJ, occupants, etc...) to determine which events take precedence over others.

The Emergency LOC Alarm entry in the Event Priority Table encompasses all ECS Alarm Events that can be activated from an LOC (LOC Mic Triggered ECS Alarm and LOC ECS 1 Alarm through LOC ECS 8 Alarm). By default, these events do not have a priority - they can be activated in any order. A programming option in HFSS exists to force a priority scheme for the LOC ECS Alarm Events. When this option is enabled, the lower numbered the ECS event is, the higher priority it has (e.g. LOC ECS 1 Alarm is higher priority than LOC ECS 8 Alarm). With this priority scheme, once a higher priority ECS Event has been activated, an ECS reset must be performed before a lower priority ECS Event can be activated.

The Event Priority Table contains the following events for modification:

Fire System	Emergency System
Fire Manual Pull Alarm	Emergency LOC Alarm
Fire Detector Alarm	Emergency 1 Point Alarm
Fire Water Flow Alarm	Emergency 2 Point Alarm
Fire Interlock Release Alarm	Emergency 3 Point Alarm

Table 10.1 : Event Priority Table

Fire Zone Aux 1 Alarm	Emergency 4 Point Alarm
Fire Zone Aux 2 Alarm	Emergency 5 Point Alarm
Fire System Aux 1 Alarm	Emergency 6 Point Alarm
Fire System Aux 2 Alarm	Emergency 7 Point Alarm
	Emergency 8 Point Alarm
	Emergency Voice Aux 1 Alarm
	Emergency Voice Aux 2 Alarm
	Emergency Voice Aux 3 Alarm
	Emergency Voice Aux 4 Alarm
CO Alarm	
Fire Pre-Alarm	
Fire Interlock Alert	
	Emergency Supervisory
Fire Supervisory	
CO Supervisory	
Trouble	
Site F Key Status	
System Status	

Table 10.1 : Event Priority Table



NOTE: Status Points, Status Voice Aux 1, Status Voice Aux 2, and Background Music are contained within the System Status event priority.

NOTE: All fire, emergency and system troubles are prioritized into the Trouble event priority

10.5.4 Priority Rules

1. Event priorities can be changed only within, not between, priority levels (defined by bold lines in “: Event Priority Table” on page 158).
2. Emergency LOC Alarm must always higher than Emergency 1-8 Point Alarm and Emergency Voice Aux 1-4 Alarm.
3. ECS events do not need to be in order by ECS number.

10.5.5 Other Priority Considerations

There are other considerations to take into account when the same event is acting on the same output group (an event being mapped to an output group.) These are prioritized in order of appearance:

- For voice system utilizing dual channel, normal mapping takes priority over alert mapping. Example: Zone 1 Manual Pull is mapped to Voice Group 1 as an Alert 1 mapping and Zone 2 Manual Pull is mapped to Voice Group 1 as a normal mapping. If Zone 1 and Zone 2 Manual Pull events are active, Voice Group 1 will annunciate the Fire Alarm message defined in the Voice Settings for the panel's assigned site.
- Event priority is considered here based on the Event Priority Table.
- If an output group is mapped both directly and through an output group template to an event, the direct map gets priority. Example: Template 1 Contains Group 1. Zone 1 Manual Pull is mapped to Template 1 and Group 1 using constant and ANSI patterns respectively. If Zone 1 Manual Pull is active, Group 1 will output ANSI.
- When an event is mapped to an output group from multiple zones, the lower numbered zone gets priority. Example: Zone 1 Manual Pull and Zone 2 Manual Pull are mapped to Group 1 using constant and ANSI patterns respectively. If Zone 1 and Zone 2 Manual Pull events are active, Group 1 will output constant.

NOTE: Status Points, Status Voice Aux 1, Status Voice Aux 2, and Background Music are contained within the System Status event priority.

NOTE: All fire, emergency and system troubles are prioritized into the Trouble event priority.

10.6 Operation Mode Behavior

The control panel can be in one or more of seven conditions at any given moment: Normal, Alarm, Prealarm, Supervisory, Trouble, Silenced, and Reset. “: Operations Mode Behavior” on page 160 describes the behavior of the panel in each of these modes.

When looking at the LCD, the screen will display FS for the “Fire System”, or CO for the “CO System”. The highest priority event will display first and include the event count (see “Highest Priority Event Display” on page 160).

Press the down arrow to view the location and type of alarm supervisory or trouble. If the panel is programmed to Auto Display Event, information describing the highest priority active event will display on the first two lines.

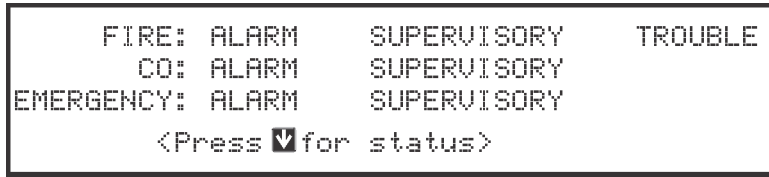

Figure 10.4 Highest Priority Event Display

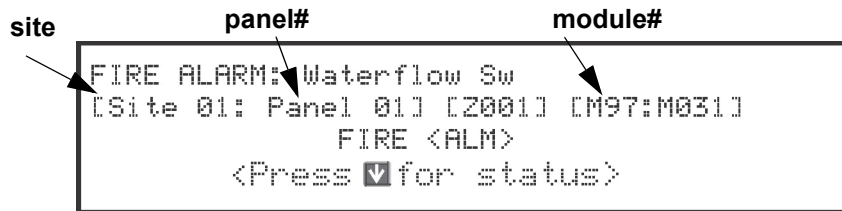

Figure 10.5 Event Display after Two Minutes Sitting idle

Operation Mode	Occurs When	System Behavior	In This Mode You Can
Normal	No alarm or trouble condition exists and menus are not in use.	SYSTEM POWER LED is on. The All Systems Normal display indicates that the system is in normal mode. The current date and time display on the last line of the LCD.	Enter the appropriate code to activate the User or Installer Menu.
Alarm	<p>A smoke detector goes into alarm or a pull station is activated.</p> <p>CO detector goes into alarm</p> <p>If more than 3 categories are active at a single time and ECS is enabled.</p>	<p>The system seizes control and will the central station.</p> <p>The on-board annunciator will sound loud, steady beeps to distinguish Alarm signals. For Fire Alarm, the sequence is a loud steady beep.(Any notification devices attached to the system will also sound). For ECS Alarm, the sequence is four seconds on, one second off. GENERAL ALARM LED is on.</p> <p>The LCD displays a screen similar to this one.</p> <div style="border: 1px solid black; padding: 5px; width: fit-content; margin: 5px auto;"> <pre> Site 1 FIRE: ALARM EMERGENCY: ALARM <Press [down arrow] for status> </pre> </div> <div style="border: 1px solid black; padding: 5px; width: fit-content; margin: 5px auto;"> <pre> CO: ALARM Site 1 <Press [down arrow] for status> </pre> </div> <p>Press the down arrow to view the type and location of alarm. (Message alternates with the date/time display).</p> <div style="border: 1px solid black; padding: 5px; width: fit-content; margin: 5px auto;"> <pre> FIRE: ALARM SUPERVISORY TROUBLE CO: ALARM SUPERVISORY EMERGENCY: ALARM SUPERVISORY SYSTEM: TROUBLE </pre> </div>	<p>Press the down arrow to view the alarm. A screen similar to this one displays.</p> <div style="border: 1px solid black; padding: 5px; width: fit-content; margin: 5px auto;"> <pre> Site 1 Panel 1 FIRE ALARM: Waterflow Sw SBUS 97 MODULE 31 05/27/16 01:45:52PM 1 of 1 </pre> </div> <p>Time/Date</p> <p>Press SILENCE to silence the annunciator (and any notification devices attached to the system). When the alarm condition clears, press RESET to restore the panel to normal.</p>

Table 10.2 : Operations Mode Behavior

Operation Mode	Occurs When	System Behavior	In This Mode You Can
Supervisory	<p>The system detects a supervisory condition.</p> <p>A Supervisory with a CO detector.</p>	<p>The system seizes control and will the central station. The on-board annunciator sounds a loud, pulsing beep to distinguish supervisory signals. For Fire Supervisory the sequence is two seconds on, two seconds off. For ECS Supervisory, the sequence is two seconds on, three seconds off. SUPERVISORY LED is on. The LCD displays a screen similar to this one.</p> <div data-bbox="565 489 979 625" style="border: 1px solid black; padding: 5px; margin-bottom: 10px;"> <p style="text-align: right;">Site 1</p> <p>FIRE: SUPERVISORY</p> <p style="text-align: center;"><Press for status></p> </div> <div data-bbox="565 678 979 793" style="border: 1px solid black; padding: 5px;"> <p style="text-align: right;">Site 1</p> <p>CO: SUPERVISORY</p> <p style="text-align: center;"><Press for status></p> </div>	<p>Press down arrow to view the fire supervisory condition. A screen similar to this one displays.</p> <div data-bbox="1027 268 1466 384" style="border: 1px solid black; padding: 5px; margin-bottom: 10px;"> <p style="text-align: right;">Device type</p> <p>Site 1 Panel 1 FIRE SUPERVISORY: Supervisory Sw SBUS 97 MODULE 32 6/17/16 12:54:10PM 1 of 1</p> </div> <p>Press SILENCE to silence the annunciator.</p>
Trouble	<p>A system trouble condition occurs.</p> <p>Trouble condition with a CO detector</p>	<p>The system seizes control and will the central station. The on-board annunciator sounds a loud, pulsing beep in the sequence ¾ of second on, eight seconds off. SYSTEM TROUBLE LED is on. The LCD displays a screen similar to this one.</p> <div data-bbox="565 1024 979 1119" style="border: 1px solid black; padding: 5px; margin-bottom: 10px;"> <p style="text-align: right;">Site 1</p> <p>FIRE: TROUBLE</p> <p style="text-align: center;"><Press for status></p> </div> <p style="text-align: center; font-size: small;">Press the down arrow to view the type and location of fire trouble condition. (This message alternates with the date / time display.)</p> <div data-bbox="565 1245 979 1339" style="border: 1px solid black; padding: 5px;"> <p style="text-align: right;">Site 1</p> <p>CO: TROUBLE</p> <p style="text-align: center;"><Press for status></p> </div> <p style="text-align: center; font-size: small;">Press the down arrow to view the type and location of fire trouble condition. (This message alternates with the date / time display.)</p>	<p>Press down arrow to view the fire trouble. A screen similar to this one displays.</p> <div data-bbox="1027 909 1466 1003" style="border: 1px solid black; padding: 5px; margin-bottom: 10px;"> <p>Site 1 Panel 1 FIRE TROUBLE: Supervisory Sw SBUS 97 MODULE 32 06/17/16 01:16:15PM</p> </div> <p>Press SILENCE to silence the annunciator. Once the trouble condition has been fixed, the system will restore itself automatically.</p>
Prealarm	<p>A single detector trips in a 2-Count zone. (2-Count means two detectors must trip before an alarm is reported.)</p>	<p>Touchpad PZT beeps. The LCD displays a screen similar to this one.</p> <div data-bbox="565 1507 979 1602" style="border: 1px solid black; padding: 5px; margin-bottom: 10px;"> <p style="text-align: right;">Site 1</p> <p>FIRE: PREALARM</p> <p style="text-align: center;"><Press for status></p> </div> <p style="text-align: center; font-size: small;">Press the down arrow to view the type and location of prealarm. (This message alternates with the date / time display.)</p>	<p>Press down arrow to view the Prealarm. A screen similar to this one.</p> <div data-bbox="1027 1507 1466 1633" style="border: 1px solid black; padding: 5px; margin-bottom: 10px;"> <p>Site 1 Panel 2 FIRE PREALARM: Det-Photo SBUS_97 SENSOR_33 06/13/16 12:54:10PM 1 of 1</p> </div> <p>All system operations are available in this mode.</p>
Reset	<p>The RESET button is pressed followed by a valid code, if necessary.</p>	<p>All LEDs are on briefly then the LCD displays "RESET IN PROGRESS". If the reset process completes normally, the date and time normal mode screen displays.</p>	<p>Menus are not available during the reset process.</p>

Table 10.2 : Operations Mode Behavior

Operation Mode	Occurs When	System Behavior	In This Mode You Can
Silenced	An alarm or trouble condition has been silenced but still exists. To silence alarms and troubles, press SILENCE followed by the Installer or User Code, if necessary.	SYSTEM SILENCE LED is on. SYSTEM TROUBLE, SUPERVISORY and/or GENERAL ALARM LED (depending on condition) is on. The annunciator (and any notification devices attached to the system) will be silenced.	Press down arrow to view the location of the alarm, supervisory or trouble. When the condition no longer exists, the SYSTEM SILENCED and SYSTEM TROUBLE LED, SUPERVISORY and/or GENERAL ALARM LEDs turn off.

Table 10.2 : Operations Mode Behavior

10.6.1 Multi-Site Annunciator and Multi-Site User Access

Multi-site Annunciators are unique as they can display the status and event history of all sites they are assigned to. These displays can be especially useful in guard shacks or security centers. A multi-site display is indicated by the words “Multi-Site Display” at the top of the idle screen.

- The ACK, DRILL, RESET and F-Macro keys are disabled until a multi-site user access code has been entered and a specific site has been selected.
- Multi-site Annunciator silencing rules:
 - If any of the assigned sites are silenced, the Silenced LED will be lit.
 - Silence key will only silence the sound from the multi-site annunciator on which the silence key was pressed. This is called being Locally Silenced. If Locally Silenced is enabled on a multi-site annunciator, it will be indicated by a blinking Silenced LED.
 - If any new troubles, supervisory, pre-alarms, or alarms are triggered in any assigned sites, Locally Silenced annunciator will resound.
 - If a multi-site annunciator is locally silenced for 4 or 24 hours depending on user selection (see section Auto-Resound (4 or 24 hours)), the locally silenced annunciator will resound.
- The IFP-2100/ECS menu system is disabled on a multi-site annunciator. Pressing the Right or Enter keys will bring you straight into event history for assigned sites. To get into the menu system, a multi-site user password must be entered and then a site must be selected from the site selection menu. Once this is done you will have access to the idle screen of that site and the annunciator will temporarily act like a single site annunciator.
- A multi-site annunciator will sound the highest priority tone from the sites it is assigned to.

NOTE: A multi-site display is created in Module programming in the edit properties menu for an annunciator. See section 9.2.1.

NOTE: An annunciator cannot be programmed as a multi-site display when it is associated with an ECS-VCM, NVCM or RVM in a ECS system.

NOTE: Status Points, Status Voice Aux 1, Status Voice Aux 2, and Background Music are contained within the System Status event priority.

NOTE: All fire, emergency and system troubles are prioritized into the Trouble event priority.

10.7 Releasing Operations

The control panel supports two types of releasing: Double Interlock Zone, and Single Interlock Zone. The Double Interlock Zone operation requires an interlock switch input in the system, and the Single Interlock Zone does not. An interlock switch is typically a dry-contact pressure switch.

When Single or Double Interlock Zone releasing is selected using HFSS Honeywell Fire Software Suite, the software suite will automatically default the following system parameters:

NOTE: The defaults created can be modified through programming if desired.

- Output Group 2 is created. Output Group 2 will be defaulted as a “Detector Alarm” output group for all releasing zones. NAC [98:001] is assigned to Output Group 2.
- Output Group 3 is created. Output Group 3 will be defaulted as a “Interlock Release Alert” output group for all releasing zones. NAC [98:002] is assigned to Output Group 3.
- Output Group 4 is created. Output Group 4 will be defaulted as “Interlock Release Alarm” output group for all releasing zones. NAC circuit [98:003] is assigned to Output Group 4.

NOTE: The installer must define which input points will be used for detectors, manual release switches, or interlock/pressure switches.

NOTE: For manual release operation, Installer must use an FM approved/ UL listed releasing manual station.

Manufacturer	Part Number	Rated Voltage, DC	Rated Current, Milliamp
Asco	T8210A107	24 VDC	700
	8210G207	24 VDC	442
	HV2740607	24 VDC	375
	HV2838521	24 VDC	375
	HV2740608	24 VDC	375
Honeywell/Skinner	701X7028	24 VDC	917
Barnbrook System	EA45	24 VDC	200
Kidde Fenwal	890181	24 VDC	2000
	486500	24 VDC	290
	895630	24 VDC	2000
	897494	24 VDC	1500
Minimax	88 7363	24 VDC	1040
	88 5738	24 VDC	1040
	88 9323	24 VDC	500
Nohmi Bosai	R85M10	24 VDC	1200
Parker Hannifin	70610006	24 VDC	417
	10610707	24 VDC	417
Snap-tite	2823A-2NB-A4F6	24 VDC	458
	2823A-2NB-A4F5	12 VDC	917
TLX	PA0036-A	24 VDC	600
Versa Valves	CGS-4232-NB3-S2	24 VDC	438
VICTAULIC	753E	24 VDC	364
	767	24 VDC	364
Viking	11591	24 VDC	417
	11595	24 VDC	417
	11592NC	24 VDC	416
	16360	24VDC	500

Table 10.3 : Approved Releasing Solenoids

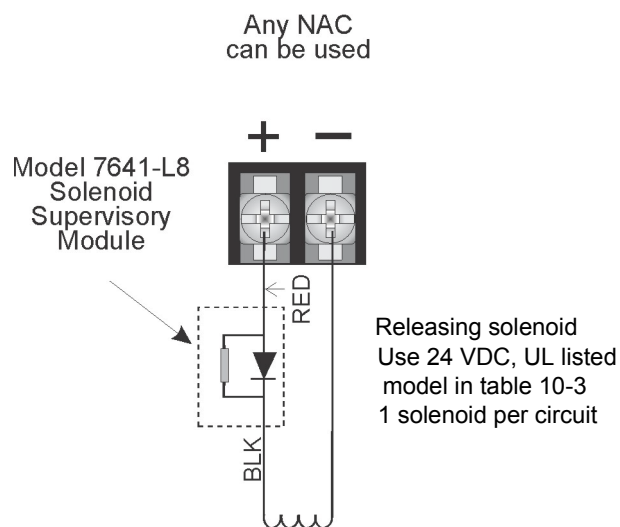

Figure 10.6 Wiring Configuration for Solenoid

*When ordering, order as P/N 7641-L8

10.7.1 Single Interlock Zone Releasing

A single interlock zone utilizes a minimum of two addressable detectors and a designated manual release switch.

Important!
Only addressable detectors can be used. No conventional detectors can be used.
Each Single Interlock Zone input requires at least one manual release switch.

■ Conditions Required for an Interlock Release Alert Output Activation

If any single addressable detector is activated, the “Interlock Release Alert” output will activate. This alerts the user that the initial stages required for a release condition are present. (Also refer to Table 10.4).

■ Conditions required for a Detector Alarm and Interlock Release Alarm Output Activation

If two or more addressable detectors, or a manual release switch activate, the “Detector Alarm” and “Interlock Release Alarm” outputs will activate. (Also refer to Table 10.4).

Inputs	Output Results								
1st Addressable Detector		X			X		X		X
2nd Addressable Detector			X		X			X	X
Manual Release Station						X		X	X
	Normal	Interlock Release Alert	Interlock Release Alert	Interlock Release Alarm and Detector Alarm	Interlock Release Alarm and Detector Alarm	Interlock Release Alarm and Detector Alarm	Interlock Release Alarm and Detector Alarm	Interlock Release Alarm and Detector Alarm	Interlock Release Alarm and Detector Alarm

Table 10.4 : Single Interlock Zone Operation

10.7.2 Double Interlock Zone Releasing

A Double Interlock Zone uses a minimum of two addressable detectors, a designated manual release switch, and an interlock switch input. An interlock switch is typically a dry-contact pressure switch and will be referred to as an interlock/pressure switch in this document.

Important!
Only addressable detectors can be used. No conventional detectors can be used.
Each Double Interlock Zone input requires at least one Interlock/pressure switch and at least one manual release switch.

■ Conditions Required for a Interlock Release Alert Output Activation

If any single addressable detector is activated, the “Interlock Release Alert” output will activate. This alerts the user that the initial stages required for a release condition are present.

■ Conditions Required for a Detector Alarm Output Activation

If two addressable detectors, a manual release switch is activated, or an interlock switch is active, the “Interlock Release Alert”, and “Detector Alarm” outputs will activate.

■ Conditions Required for a Interlock Release Alarm Output Activation

Any release requires the activation of an interlock switch, and either a manual release switch or 2 activated addressable detectors. When these conditions are met, the “Interlock Release Alarm” and “Detector Alarm” outputs will activate, and the “Interlock Release Alert” outputs will deactivate.

Inputs	Output Results													
1st Addressable Detector		X		X		X		X		X		X		X
2nd Addressable Detector			X	X			X	X			X	X		X

Table 10.5 Double Interlock Zone Operation

Inputs		Output Results														
Manual Release Station					X	X	X	X					X	X	X	X
Interlock/Pressure Switch									X	X	X	X	X	X	X	X
	Normal	Interlock Release Alert	Interlock Release Alert	Interlock Release Alert and Detector Alarm	Interlock Release Alert and Detector Alarm	Interlock Release Alert and Detector Alarm	Interlock Release Alert and Detector Alarm	Interlock Release Alert and Detector Alarm	Interlock Release Alert and Detector Alarm	Interlock Release Alert and Detector Alarm	Interlock Release Alert and Detector Alarm	Interlock Release Alert and Detector Alarm	Interlock Release Alarm and Detector Alarm	Interlock Release Alarm and Detector Alarm	Interlock Release Alarm and Detector Alarm	Interlock Release Alarm and Detector Alarm

Table 10.5 Double Interlock Zone Operation

10.8 Smoke Alarm Verification

Figure 10.7 illustrates how the Smoke Alarm Verification cycle operates.

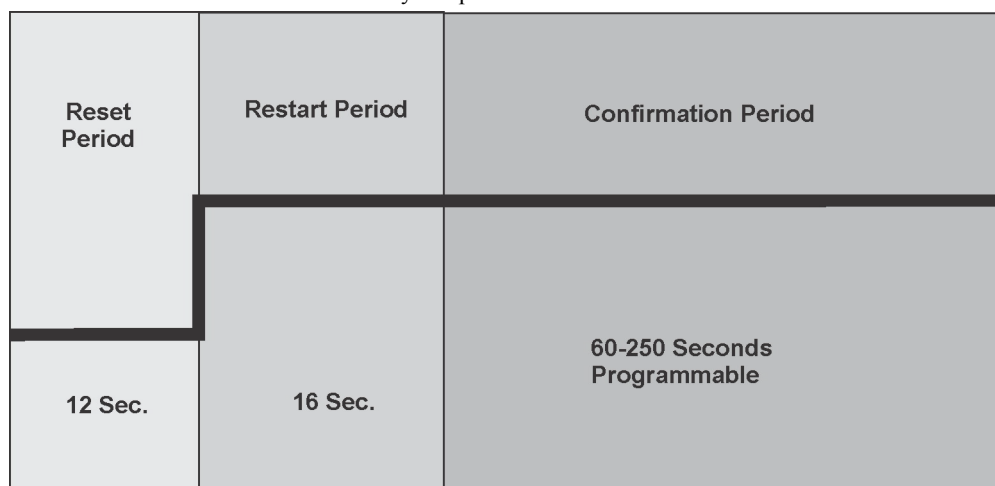

Figure 10.7 Smoke Verification Cycle

During the Confirmation Period if there is no alarm indication then the system will return to normal operation.

10.9 Function Keys

The function keys on the IFP-2100/ECS have multiple features. Their macro key functionality can simplify the disabling, activating, or inhibiting points or groups respectively. They can also be used as a status type activation event and for activating Map Inhibit. Each F-Key macro can hold 50 events.

■ **To access the F-Key Recording menu:**

1. From the idle screen, press and hold the F-Key for 5 seconds.
2. Enter a PIN with F-Key macro recording privileges, if prompted.

10.9.1 Recording an F-Key Macro

1. Access the F-Key Recording menu and select the ‘Start FKEY Recording’ option.
2. The panel will return to the idle screen. Notice the 4th line on the display now alternates with <F# Key Recording>, where # is the number of the F-Key being recorded.

3. Any Disabling or Activating of points, output groups, or templates from the site at this point will be programmed into the macro. Do this by going to any annunciator within the site and entering Main Menu -> Point Functions and use Disable/Enable Point or use I/O Point Control to: disable output groups or individual points, or activate individual points.
4. Once you are finished with disabling or activating points/output groups, enter the F-Key Recording Menu again and select the 'End F-KEY Recording' option.
5. The panel will return to the idle screen.

10.9.2 Aborting an F-Key Macro Recording Session

1. After an F-Key macro recording session has been started, the session can be canceled at any time by accessing the F-Key Recording menu and selecting 'Abort F-KEY Recording' option.
2. The panel will return to the idle screen.

10.9.3 Erasing an F-Key Macro

1. If an F-Key macro has already been recorded, you can erase it by accessing the F-Key Recording menu and selecting the 'Erase F-KEY Macro' option.
2. The panel will return to the idle screen.

10.9.4 Using a Recorded F-Key Macro

1. From the idle screen on any annunciator in the site, press the F-Key you want to activate.
2. Once finished, to de-activate the macro press the F-Key again.

10.9.5 F-Key Status Event

When an F-Key is enabled, it activates its corresponding F-Key Active event. This is a status type event that can activate outputs without showing any status on annunciator displays. This should be used for ancillary purposes only.

10.9.6 F-Key Map Inhibit

The F-Keys have the ability to disable event - output group mapping for the purpose of simulating that the map doesn't exist. This can be setup to allow for testing purposes where notification of an entire building is not desired during the test. This option is programmable for each output group map through HFSS Honeywell Fire Software Suite.

When an F-Key is active and a map in the system is set to be disabled by Map Inhibit, the system will show a trouble event indicating it as such.

Section 11: Emergency Communication System Operation

11.1 Overview

The IFP-2100/ECS control panel and accessories provides features to meet the requirements for a Mass Notification Systems as described in NFPA 72 and is compliant with the UL 2572 standard. The ECS (Emergency Communication System) is integrated with the fire alarm and voice evacuation functions of the control panel. In a networked panel system, only one panel can be chosen to be the voice evacuation/ECS panel for the site.

There are two ways for activating ECS in the IFP-2100/ECS panel:

■ ECS Point Activations

ECS Point Activation involves using pre-determined ECS Alarm input points to activate ECS Alarm events. These events cause output areas to activate based on mapping that is programmed into the system at installation. This is very similar to the traditional mapping that the fire system has utilized to date.

■ Manual LOC Activations

Manual LOC Activation involves using the LOC ECS interface to activate ECS Events, choose output areas, and speak through a microphone. These selections are not pre-determined and allow the user to make system functionality decisions when the event is actually happening. This requires the activation of Manual ECS State which bypasses ECS Point Activations. See section 11.2.3.

11.2 LOC Functionality

An LOC (Local Operating Console) consists of either the ECS series panel (ECS-VCM Voice Control Module, or ECS-NVCM Network Voice Control Module, and the Alarm Control Panel), or the ECS-LOC Local Operating Console (ECS-RVM Remote Voice Module and its associated RA-2000 keypad.) An LOC is created by adding a VCM, NVCM or RVM to the system and associating a keypad to it. The LOC provides eight buttons for activating the ECS messages, a button to gain and request ECS Control, and a microphone for live paging. There can be up to 16 LOC devices in the system. In a networked panel system, all of the LOCs must be connected through SBUS to the panel that includes the VCM or NVCM.

11.2.1 Keys and LEDs

This section outlines the functionality of the keys and LEDs on the ECS-VCM or ECS-NVCM and ECS-RVM expander modules.

ECS Control Key

Pressing the ECS Control Key will do one of two things:

1. Enter Message Mode of the LOC ECS interface (including trying to gain ECS Control if the user doesn't have it already).
2. Relinquish ECS Control if pressed while in Message Mode.

ECS Control LED

The ECS Control LED is used to indicate the status of ECS Control in the system. When the LED is on solid, the LOC has ECS Control within the system. When the LED is blinking, another LOC has gained ECS Control in the system.

ECS Message Keys

ECS Message Keys are used in Message Mode to select which ECS Message is to be played. If pressed when the LOC does not have ECS Control, the system will automatically try to gain ECS Control before allowing the ECS Event to be activated. See section 11.2.2.

ECS Message LEDs

The red ECS Message LEDs indicate the active ECS Message and any previously active ECS messages. The green LEDs indicate the ECS Message was selected in message mode and that the LOC has ECS control.

1. For ECS Point Activation, the red ECS Message LEDs will illuminate on each LOC to indicate which ECS messages have been activated in automatic ECS state.
2. In Manual ECS State, the red ECS Message LEDs will indicate which ECS message has been activated at an LOC. See section 11.2.3.
3. The green ECS Message LEDs will activate for the LOC that activated the ECS Message.

Select Keys

The Select Keys are used to toggle which output areas are active.

1. If Message Mode is active (see Section 11.2.3), the Select Keys will activate output which areas for the active message to be played in (also activates the red Select Key LED).



NOTE: For LOC activated emergency alarm events, if an area is programmed through mapping to be active that area is automatically selected and can not be deactivated using the Select Keys

2. If Microphone Mode is active (see Section 11.2.3), the Select Keys will toggle which areas the microphone audio is distributed to (also toggles the green Select Key LED).

Select Key LEDs

The Select Key LEDs are used to indicate which output areas are active for a microphone page (see Section Paging) or system events.

1. Green LEDs: active areas for microphone paging.



NOTE: These are only active when the microphone PTT (Push To Talk) is engaged. Blinking indicates one or more associated network page destination panels are unable to output the page.

2. Red LEDs: active areas for system events.



NOTE: When system is Dual Channel Enabled, blinking indicates the area is active for an alert message

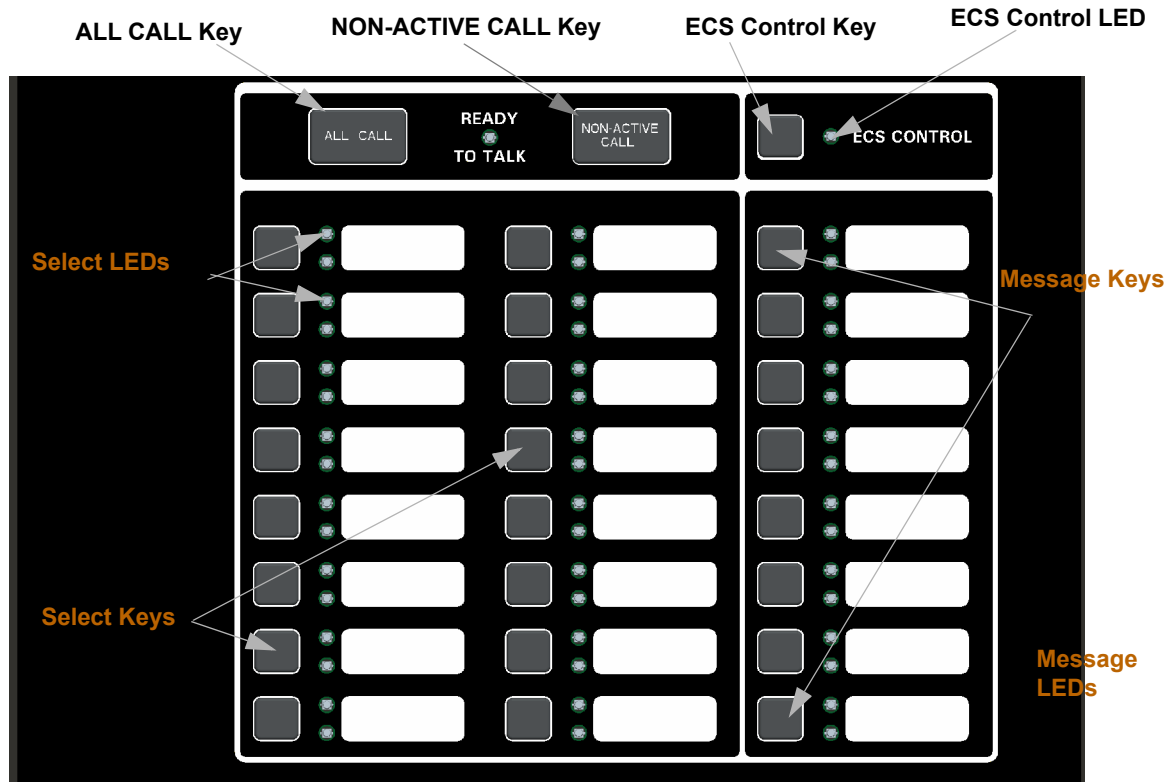

Figure 11.1 ECS-VCM or ECS-NVCM / ECS-RVM Front View

11.2.2 Gaining ECS Control

When attempting to gain ECS Control, there are three things that govern whether or not ECS Control can be obtained:

1. LOC Priority.
2. LOC Lockout.
3. User profile access control.

LOC Priority

LOCs are assigned (through panel or HFSS Honeywell Fire Software Suite of the ECS-VCM, ECS-NVCM or ECS-RVM) an LOC priority of low, normal, or high. LOCs with a higher priority are always able to gain control from a lower priority LOC.

LOC Lockout

When LOCs are programmed to the same priority, the setting LOC lockout applies. LOC lockout will not allow an LOC to gain ECS Control from the LOC with ECS Control until one of three things happen:

1. The LOC lockout timer expires. Once the LOC lockout timer expires, an attempt to gain ECS Control can be made again.



NOTE: The lockout timer must be programmed to expire sometime other than Never.

2. The user at the second LOC requests ECS Control from the LOC with ECS Control and that LOC grants the request. (See Section 11.2.7). If the ECS lockout timer expires while an ECS Control request is in progress, the system will automatically pass ECS Control to the requesting LOC.
3. The user at the second LOC enters an access code with the ECS Super User profile option.

The LOC lockout timer can be set between immediate and 12 hours in increments of 1 second or it can be set to never expire. The default setting is 30 seconds. The LOC lockout timer is restarted upon any key press at the LOC with ECS control. The LOC lockout timer is cleared when ECS Control is relinquished.

User Profile Access Control

The user will need to enter an access code containing the ECS Control Request or ECS Super User profile option to gain ECS Control. ECS Control Request and ECS Super User profile options will be mutually exclusive to the system. If the access code has ECS Super User, the ECS Control Request is ignored and activations by that user are always as ECS Super User.

11.2.3 Manual ECS

After gaining ECS Control the system enters the LOC ECS interface which allows you to activate the Emergency System and allows for Emergency Paging. Once an emergency event has been activated the panel enters a Manual ECS State. In this state, all ECS Alarm programmed points that are currently in alarm in the system are changed to an active state. The display status screen reflects this when viewing the system for status. Any outputs that were activated by the ECS Alarm programmed points are deactivated until Manual ECS state is exited. Only an ECS Reset can exit the Manual ECS State. If a user gains ECS Control at an LOC and does not activate an ECS message, the system will automatically generate an ECS Supervisory indicating such. This prevents an LOC from being in an undesired state of ECS Control when an actual event emerges.

There are two modes for interacting with the LOC ECS interface when in Manual ECS State:

1. Message Mode
2. Microphone Mode

These two modes allow you to quickly toggle areas of output for a desired message or to speak to a microphone for ECS Paging.

After gaining ECS Control, the system is in Message Mode of the Manual ECS State.

Switching between Microphone Mode and Message Mode

At any time while in ECS Control, you can switch between Microphone Mode and Message Mode. Microphone Mode is entered by simply engaging the microphone.

1. Message Mode: Use the ECS Message keys to toggle which message/event to output to the system. Use the Select Keys to toggle output areas to play the current ECS Message in. The Select Key's red LED will toggle on/off with the activation/deactivation of the area is now receiving the message. Any non-voice groups assigned to this Select Key will also toggle with their Activation Cadence. See Section Activating Output Groups Dynamically.
2. Microphone Mode: Use the Select Keys while the microphone is active to toggle which areas to do an ECS Microphone Page to. The Select Key's green LED will toggle on/off with the activation/deactivation of the ECS Microphone Page to the area.

Activating Output Groups Dynamically

This method allows the system to be setup with minimal or no system mapping. When in Manual ECS State and operating in Message Mode the user can dynamically activate/deactivate output areas for system notification to take place in. The Select Key red LED will become lit and the circuits in the output group(s) will become active and play the currently active ECS event message when activated. When deactivated, the Select Key red LED will become unlit and the circuits in the output group(s) will become inactive. Non-voice output groups can also be assigned to Select Keys and will toggle on/off using the activation cadence assigned to it in output group programming. This is available in the panel and in HFSS Honeywell Fire Software Suite. See Section Edit Group Properties.

11.2.4 Microphone Mode

Microphone Mode allows the user to press the Select Keys to toggle which output areas to speak to over the microphone. The green LEDs next to the Select Keys will activate or deactivate.

```

MICROPHONE MODE
SELECT KEYS: Toggle Output Areas
Microphone Active
Release Microphone for MESSAGE MODE

```

11.2.5 Message Mode

In Message Mode, the user is able to press the ECS message Keys to choose a message and press the Select Keys to activate or deactivate which output areas the message will be played. This will activate or deactivate the green and red LEDs next to the ECS Message Keys and the red LEDs next to the Select Keys.

11.2.6 Custom ECS Event

Custom ECS events allows the user to generate an ECS event and speak a custom message using the microphone. Once the user is done speaking the message, the tone and any associated strobes will continue to be active in the output areas.

To generate a Custom ECS Event:

1. Gain ECS Control using the ECS Control Key when there is not an ECS Event active.
2. Activate the microphone.
3. Choose desired output areas using the Select Keys.

4. Speak custom message into microphone.

11.2.7 Passing ECS Control

Passing of ECS Control is allowed when two LOCs have the same priority. When it is possible to pass control, a prompt (similar to Figure 11.2) will display in which the user can: request control from the LOC with ECS Control, enter an access code with the ECS Super User profile option to override the other LOC, or wait for the lockout timer to expire (if applicable).

```
GAIN ECS CONTROL OPTIONS MENU
1=Request ECS Control From LOC
2 Gain ECS Control as ECS Super User
3 Wait for Lockout Timer to Expire 30
```

Figure 11.2 Request ECS Control with Lockout Timer Active

When passing ECS Control between two ECS Super Users, the user is not shown the prompt screen. Instead, a request for ECS Control is automatically made. Additionally, the lockout timer does not apply for ECS Super User.

When a request for ECS Control is made, the LOC with ECS Control will be shown a screen (similar to Figure 11.3), even when in another menu, except programming menus, indicating that another LOC is requesting ECS Control. The piezo buzzer on the LOC with ECS Control sound when an ECS Control request is active to alert a nearby operator of the request.

```
Another LOC is Requesting ECS Control:
                ECS-LOC 01
1=Grant, Pass ECS Control
2 Deny, Keep ECS Control
```

Figure 11.3 ECS Control Request on LOC with ECS Control

Once ECS Control is passed to another LOC, the new user will assume the system AS IS. This means that the event that was set to be playing at the previous LOC and all output areas it was playing in do not change.

11.2.8 Exit ECS Control Menu

The user can exit the LOC ECS interface by pressing the left arrow key. The user will be returned to the idle screen which indicates that the LOC still has ECS control.

11.2.9 Relinquish ECS Control

Relinquishing ECS Control is accomplished by pressing the ECS Control Key from within Message Mode. A screen will be displayed to ensure the user wants to relinquish ECS Control. ECS Control will be automatically relinquished after a time-out on this screen. When ECS Control is relinquished, the system stays in the Manual ECS State. ECS Control can then be gained by another LOC or again at the same LOC.

```
Relinquish ECS Control
Automatic ECS Timer: 30
1=Cancel, Keep ECS Control
2 Accept, Relinquish ECS Control
```

Figure 11.4 Relinquish ECS Control Screen

11.2.10 ECS Reset

An ECS reset is accomplished by pressing the RESET button from an LOC. The user will be prompted to reset either the fire system or emergency system. After an ECS reset, the LOC will automatically exit the LOC ECS interface.



NOTE: In order to perform an ECS reset, the display must be associated with the ECS-VCM or ECS-NVCM / ECS-RVM. See Section 11.6.2

11.3 ECS Super User

The ECS Super User access code profile function provides the ability to override all ECS Control rules and gain ECS Control. The ECS Super User is the highest priority user in the system. The ECS Super User has several features that differ from the normal user:

1. Any alarm activated while under ECS Super User Control needs to be reset using an ECS Super User function enabled access code.

2. LOC priority and LOC lockout timer are ignored when passing ECS Control between ECS Super Users at LOCs. If another ECS Super User attempts to gain ECS Control from an LOC, an ECS Control request is presented to the ECS Super User at the LOC that currently has ECS Control.

11.4 ECS Point Functionality

Any input point in the system can be configured as an ECS input. The Point ECS 1-8 Alarm input types can be used to trigger predetermined ECS events for output areas. ECS-VCM, ECS-NVCM or ECS-RVM points can be programmed to trigger Voice Aux events that can allow external audio to be played through the emergency system.

11.4.1 ECS Point Activations

ECS points can only activate outputs and be placed into an alarm state if the system is not in Manual ECS State. ECS points have no priority and all are allowed to be activated. If the ECS point is a higher priority than the Fire System, then the system will play the highest event message through all ECS mapped outputs.

For example: Emergency 1 Point Alarm is higher priority than Emergency 2 Point Alarm. Emergency 1 Point Alarm has message 1 mapped to through groups 1 and 2. Emergency 2 Point Alarm has message 2 playing through groups 2 and 3. If a point for Emergency 1 Point Alarm and a point for Emergency 2 Point Alarm are both active, the system will play message 1 through groups 1, 2, and 3.

Once Manual ECS State is active, points in Alarm state switch to an Active state. When the points are changed to the Active state, they do not activate any system mapping or turn any outputs on. Any points that are activated while in Manual ECS are also placed into the Active state and are not allowed to activate any mapping. The system idle screen will show an ECS Alarm for any points in the Active state, and the detailed description of the point will show the point as Active.

After an ECS Reset, any ECS points that are still active will again be put into Alarm.

11.4.2 ECS-VCM, ECS-NVCM & ECS-RVM Points

The ECS-VCM, ECS-NVCM & ECS-RVM modules contain two programmable input points. These can be programmed as any conventional switch input type. These also have the ability to be programmed as a trigger for bringing external audio into the system. These special point types are: ECS Voice Aux In 1-4 Alarm, Voice Aux In 1-2 Status, Background Music. When activated if the event has the highest Event Priority of all activated events, it will activate the Aux In input to all outputs defined by the respective event program mapping.

NOTE: Background Music is only allowed to be mapped to circuit 8 of the ECS-DUAL50W amplifiers to ensure correct active supervision.

11.5 Amplifier Programming

11.5.1 Adding an Amplifier

To add a new amplifier to the system, follow these steps:

1. Enter the installer code. The panel will automatically go to the main menu.
2. Select 7 for Panel Programming menu.
3. Press 1 to enter Module menu.
4. Press 2 to add a module.
5. From the next screen, add an ECS-AMP.

The screen will display "Adding module [#]..." for a few moments. You will be returned to the <New Module Type> screen where you can select another a name for the module(s) if desired.

You must save changes when you exit the Program Menu or the new module will not be added. For more information see section 9.2.2.

If you Add a Module that has not been physically connected, the panel will go into trouble after it re-initializes (when you exit the Program Menu with changes accepted). When the new module is attached, the trouble will restore automatically the next time you power up the FACP.

11.5.2 Editing an Amplifier

When editing AMPs, the features that may be edited are: module ID, module name, amplifier mod, ECS-CE4 installed (Yes or No), and output voltage. To edit an existing module:

1. Enter the installer code. The panel will automatically go to the main menu.
2. Select 7 for Program Menu.
3. Press 1 to enter module menu.
4. Press 1 to edit a module.
5. Use the up or down arrow key to select the module you wish to edit.
6. Press the right arrow key or ENTER to move to next selection.

11.6 LOC Programming

LOC Priority is a programmable option for the following ECS devices:

- ECS-VCM
- ECS-NVCM
- ECS-RVM

11.6.1 Adding an LOC

To add new LOCs to the system, follow these steps:

1. Enter the installer code. The panel will automatically go to the main menu.
2. Select 7 for Panel Programming menu.
3. Press 1 to enter Module menu.
4. Press 2 to add a module.
5. From the next screen, add either an ECS-VCM or ECS-NVCM* or ECS-RVM**.

* *Only 1 ECS-VCM or ECS-NVCM may be installed per site.*

** *Up to 15 ECS-RVMs may be installed per site.*

The screen will display “Adding module [#]...” for a few moments. You will be returned to the <New Module Type> screen where you can select another a name for the module(s) if desired.

6. Add a compatible LCD Annunciator, if desired, to associate with each ECS-VCM, ECS-NVCM or ECS-RVM.

You must save changes when you exit the Program Menu or the new module will not be added. For more information see section 9.2.2.



NOTE: If you Add a Module that has not been physically connected, the panel will go into trouble after it re-initializes (when you exit the Program Menu). When the new module is attached, the trouble will restore automatically the next time you power up the system.

11.6.2 Editing an LOC

Settings that are specific to an LOC are modified by editing the ECS-VCM, ECS-NVCM or ECS-RVM expander module of the LOC. These options may include: number of switch expanders installed, microphone type, microphone gain, auxiliary gain, tone gain, message gain, keypad priority, associated keypad, Port 1 used, Port 2 used, Select Switch, Panel, and Network Paging.



NOTE: An LOC specific name can also be editing using HFSS Honeywell Fire Software Suite.

To edit an existing module:

1. Enter the installer code. The panel will automatically go to the main menu.
2. Select 7 for Program Menu.
3. Press 1 to enter module menu.
4. Press 1 to edit a module.
5. Use the up or down arrow key to select the module you wish to edit.
6. Press the right arrow key or ENTER to move to next selection.

LOC Priority

Each device is assigned a Priority level: Low, Normal, or High. This is modified by editing the LOC’s ECS-VCM, ECS-NVCM or ECS-RVM module. By default, the ECS-VCM or ECS-NVCM has a high LOC priority. The ECS-RVM is defaulted to normal LOC priority.

LOC Association

In order to created an LOC, an annunciator must be associated to an ECS-VCM, ECS-NVCM or ECS-RVM. This done by editing the ECS-VCM, ECS-NVCM or ECS-RVM module and selecting the correct annunciator for the associated device. During JumpStart, the ECS-VCM or ECS-NVCM is automatically associated with the internal annunciator. The association for other LOCs in the system must be performed in programming.

11.7 Using the Microphone

11.7.1 Microphone Functionality

Each microphone in the system is capable of providing convenience, fire or emergency paging. A convenience or fire page can be made anytime the emergency system does have System Control (see Section 10.5.1). When the emergency system has been activated and has System Control, the user must gain ECS Control to do an emergency page.

The microphones are housed within the ECS-Series panel enclosure and the ECS-LOC/ECS-RPU cabinets. A maximum of 16 microphones can be installed in the system.

11.7.2 Custom ECS Event

This event is activated by gaining ECS Control at a LOC and using the microphone without any ECS event already active in the Manual ECS State. In this case, the Mic Triggered ECS Alarm mapping and General ECS Alarm mapping will be activated and stay activated until a different ECS event is activated at the LOC or the user resets the Emergency Communication System.

11.7.3 Fire Page

A fire page can only occur when:

1. Only the fire system is active.

- Both fire and the emergency systems are active and the highest priority active fire event is programmed to be of higher priority than the highest priority active emergency event.
- Only the fire system is active, the user has gained ECS Control, and custom ECS event is a lower priority than the fire alarm.



NOTE: If fire and emergency systems are active and emergency system is of a higher priority, a fire page is NOT allowed. An LOC must gain ECS Control in order to do any live voice.

11.7.4 Emergency Page

An emergency page can occur when:

- Only the emergency system is active and the user has gained ECS Control.
- Both fire and the emergency systems are active and the highest priority active emergency event is programmed to be of higher priority than the highest priority active fire event and the user has gained ECS Control.
- Only fire system is active, the Emergency LOC Alarm priority is higher than the active fire system event and the user has gained ECS Control.
 - This will trigger the ECS system and enable mapping for 'Mic Triggered ECS Alarm' and 'General ECS Alarm'.

Paging

If there are no active emergency or fire system events, the microphone at an LOC can be used for paging by following these steps:

- Push the PTT (push to talk) button on the microphone.
- Use the Select Keys on the LOC to toggle the output areas to page to with the microphone (illuminates the green LEDs).

NOTE: The Ready to Talk LED will illuminate after an output area has been activated.

- Speak into the microphone.
- Release PTT button when finished.

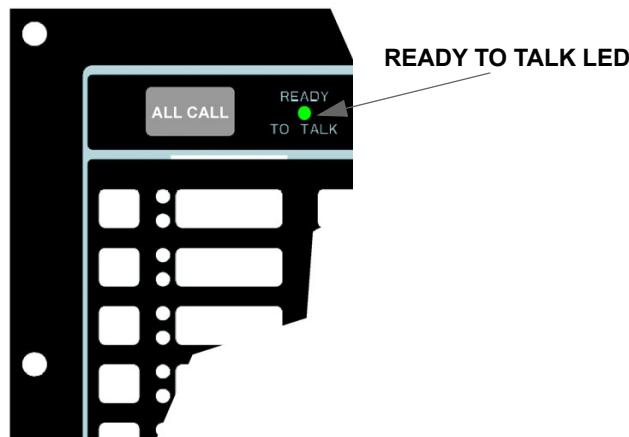

11.8 Recording Custom Messages

The ECS-Series VCM or ECS-NVCM comes with 15 recordable message slots. Message 1-15 can be recorded from: the microphone, Aux Input, or by using the ECS Message Management utility of HFSS Honeywell Fire Software Suite. All messages can be a maximum of one minute.

When in the record mode, the ECS-VCM or ECS-NVCM keys will function as follows:

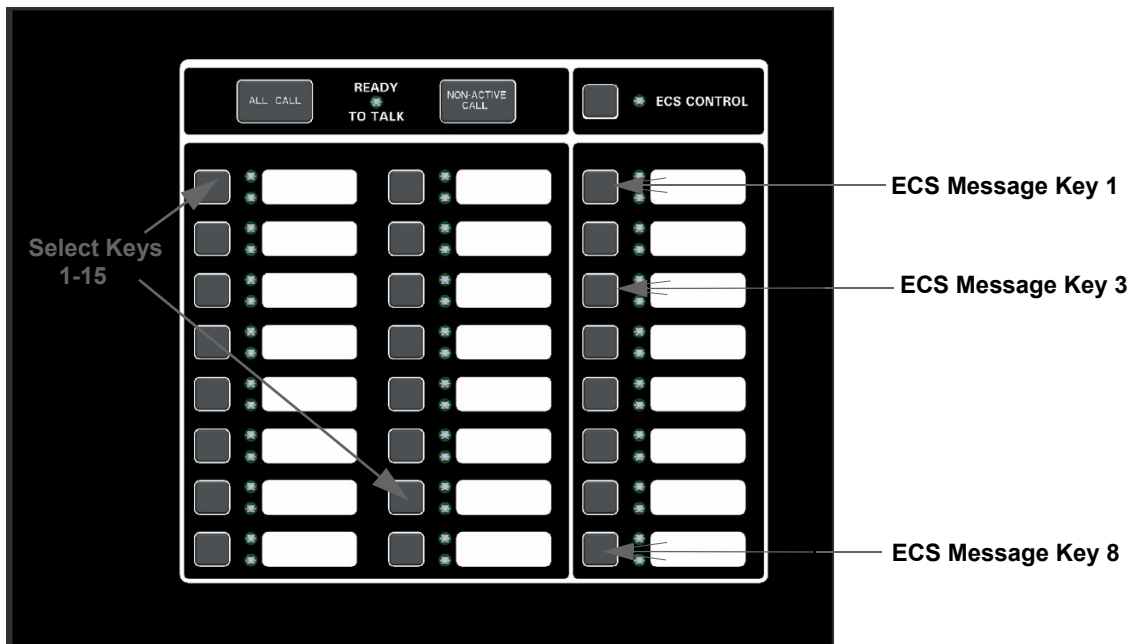

Key	Function
ECS Message Key 1	Select message slot to record to.
ECS Message Key 3	Start and stop recording from Aux. Audio Input
ECS Message Key 8	Erase user message 1-15
Select Keys 1-15	Message slot 1-15

While in the Local Record mode, Select Keys 1-15 will be used to reference message slots 1-15. The associated green Select Key LED will indicate that a message is currently programmed in the corresponding slot. When there is no message recorded (or the message is erased), the associated green Select Key LED will be off. While recording a particular message, the associated red Select Key LED will turn on until recording is completed. The Select Key 1-15 will be used to playback a recorded message or to select the message slot to record to or erase.

When in the Local Record mode, the ECS-VCM or ECS-NVCM LEDs will function as follows:

LED	LED State	Meaning
Select Key 1-15 Green LED	On	Message is currently programmed in this slot
Select Key 1-15 Red LED	On	Message recording is in progress
Select Key 1-15 Green/Red LED	Off/Off	Message slot is empty
Select Key 1-15 Red LED	Flashing	Message is being played back or message is selected for recording

Table 11.1 LED Functions During Programming

11.8.1 Recording Messages 1-15 Using Aux Audio Input

Recording messages from the Aux Audio Input enables you to load customized, pre-recorded messages into an ECS message location. Follow these steps to record a user message using Aux Audio Input:



NOTE: Refer to section 9 for detailed programming information.

1. Wire a speaker cable with 1/8" mini plug to the Aux AUDIO GND and IN terminals. Refer to Figure 11.5.

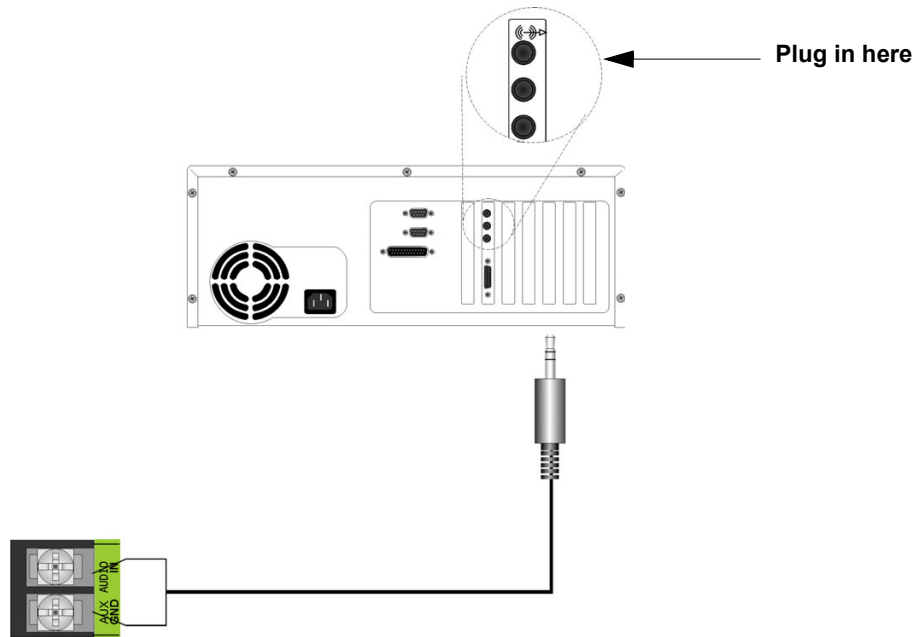

Figure 11.5 Aux Audio Connection for Recording

2. Plug the mini plug into the Line Out/Headphone jack on a PC or laptop. See Figure 11.5.
3. Enter programming mode at main control panel.
4. Select 8 for Voice Options.
5. Select 1 for VCM Maintenance.
6. Select 2 Local Recording.
7. Select the amplifier and circuit for the audio to play through during programming. A user would generally pick the audio circuit that is in closest proximity to them.



NOTE: The VCM will light the green Select Key LED for message slots that are occupied. If a message is already stored in the desired slot, then you must erase the message first. (see Section 11.8.3).

8. Press ECS Message Key 1 to enter the message slot selection mode. Then, press the Select Key 1-15 that corresponds to the message slot that you wish to record to. The associated Select Key red LED will begin flashing, indicating that the message slot is ready for recording.
9. Simultaneously press ECS Message Key 3 and start playing the audio source on the PC or laptop.
10. When the audio file from the PC is finished playing, press ECS Message Key 3 again to stop the recording. The Select Key green LED will come on.
11. To playback the recorded message, press the Select Key 1-15 that was just recorded to.

■ Recording with Aux Audio Input Example:

The user wants to record into memory slot 2 via the Aux Audio Input channel.

Upon entering the Local Recording mode via the keypad menu, the VCM will light the Select Key green LEDs 1-15 for each occupied message slot.

If a message already exists in message slot 2, it must first be erased. Press ECS Message Key 8, then press Select Key 2, (see Section 11.8.3). When the message has been erased Select Key 2's green LED will turn off.

To record a message, press ECS Message Key 1, then press Select Key 2 (this will use message slot 2 for the recording). Select Key 2's red LED will begin flashing.

Press ECS Message Key 3 while simultaneously pressing play on the PC to start recording the Aux Audio Input. When the PC message is done, press ECS Message Key 3 to stop recording. Select Key 2's red LED will stay on until processing is completed. Select Key 2's green LED comes on after the recording is completed.

Pressing Select Key 2 will start a playback of the recorded message.

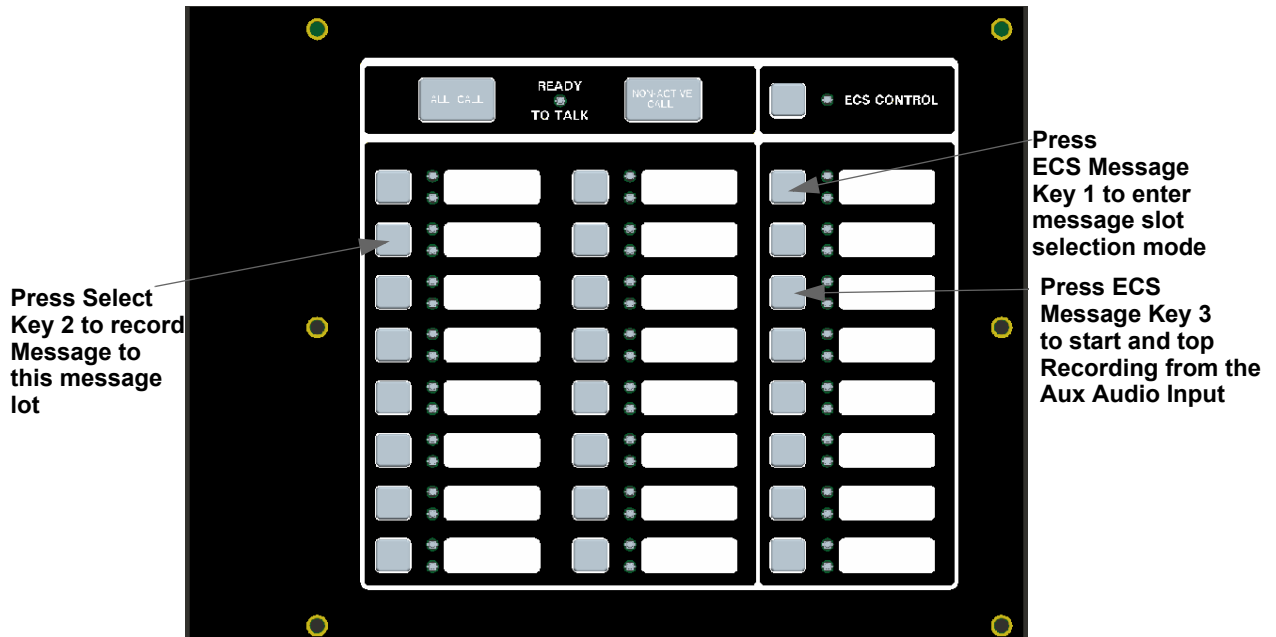

Figure 11.6 Aux Audio Input Example

11.8.2 Recording Messages 1-15 Using the Microphone

Messages can be recorded into the ECS system by using the on-board microphone.

Follow these steps to use the microphone to record your message:

1. Enter programming mode at main control panel.
2. Select 8 for Voice Options.
3. Select 1 for VCM Maintenance.
4. Select 2 Local Recording.
5. Select the amplifier and circuit for the audio to play through during programming. A user would generally pick the audio circuit that is in closest proximity to them.



NOTE: The VCM will light the green Select Key LED for message slots that are occupied. If a message is already stored in the desired slot, then you must erase the message first. (see Section 11.8.3).

6. Press ECS Message Key 1 to enter the message slot selection mode. Then, press the Select Key 1-15 that corresponds to the message slot that you wish to record to. The associated Select Key red LED will begin flashing, indicating that the message slot is ready for recording.
7. Press the push-to-talk (PTT) button on the microphone and speak your message.
8. Release the PTT button on the microphone to save your message. The Select Key green LED for this location will turn on.
9. To playback the recorded message, press the Select Key 1-15 that was just recorded to.
10. If you are not satisfied with the recorded message, erase it (see Section 11.8.3) and then repeat steps 1 through 7.

■ Recording with Microphone Example:

User wants to record a message to message slot 5 via the microphone.

Upon entering the Local Recording mode via the keypad menu, the VCM will light the Select Key green LEDs for 1-15 for each occupied message slot.

If a message already exists in message slot 5, it must first be erased. Press ECS Message key 8, then press Select Key 5, (see Section 11.8.3). When the message has been erased Select Key 5's green LED will turn off.

To record a message, press ECS Message Key 1, press Select Key 5 (this will use message slot 5 for the recording). Select Key 5's red LED will begin flashing.

Press the push-to-talk button on the microphone and speak your message. Release the PTT button to save your message. Select Key 5's red LED stays on until processing is completed. Select Key 5's green LED comes on after the recording is completed.

Pressing Select Key 5 will start a playback of the recorded message.

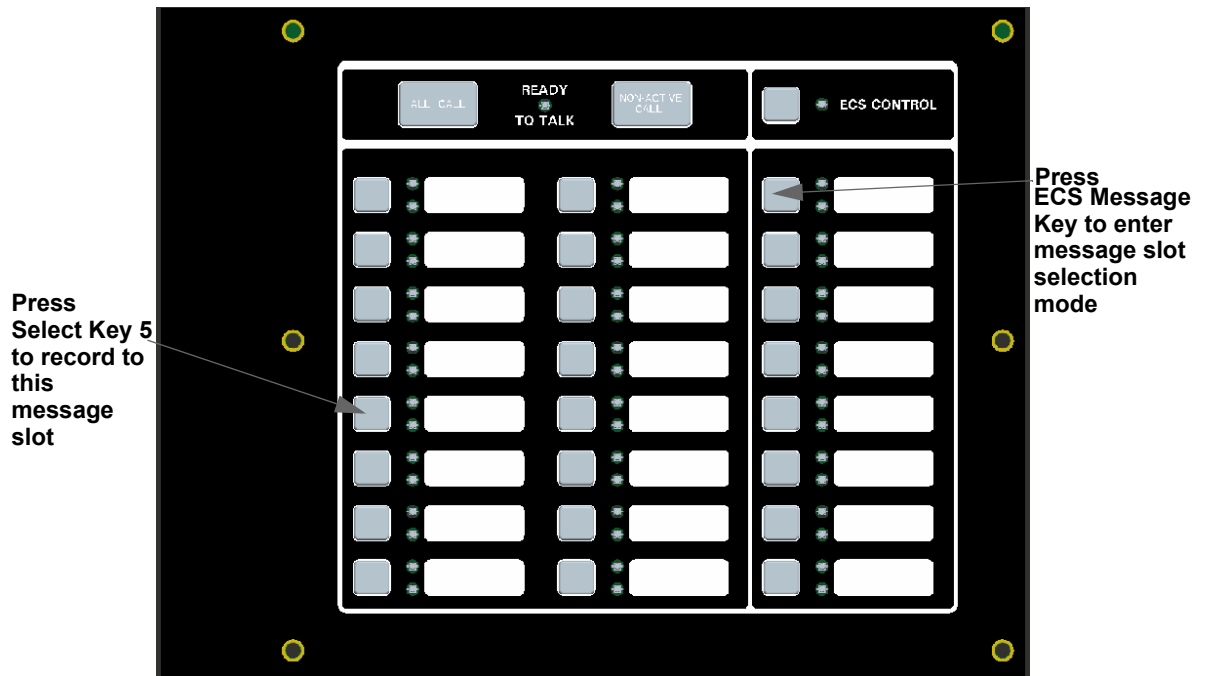

Figure 11.7 Recording with Microphone Example

11.8.3 Erasing User Message

To erase the message stored in message slot 1-15, follow these steps:

1. Enter programming mode at main control panel.
2. Select 8 for Voice Options.
3. Select 1 for VCM Maintenance.



NOTE: The VCM will light the green Select Key LEDs for message slots that are occupied (can be erased).

4. Select 2 Local Recording.
5. Select the amplifier and circuit for the audio to play through during programming. A user would generally pick the audio circuit that is in closest proximity to them.
6. Press ECS Message Key 8 on the VCM, press the Select Key 1-15 that you wish to erase. The Select Key red LED will stay on until the erase is done. When erased, the Select Key green LED by corresponding to the message slot you erased will go off.

11.8.4 Using HFSS Voice Message Load Software

The HFSS Voice Message Load Software is a software support utility that is used to download recorded messages (in .SKE format stored on your PC hard drive) to the various message locations of the ECS-Series VCM or ECS-NVCM. Messages can be uploaded from the ECS-VCM or ECS-NVCM, stored, and used again in similar installations.

To read/write .SKE formatted messages to and from the main panel, follow these steps:

1. Make sure that panel is in Normal mode.

2. Connect the PC to the FACP USB port using a standard USB cable. ECS-NVCM will use the USB on the FACP (See Figure 11.8). ECS-VCM will use the USB port on the ECS-VCM.

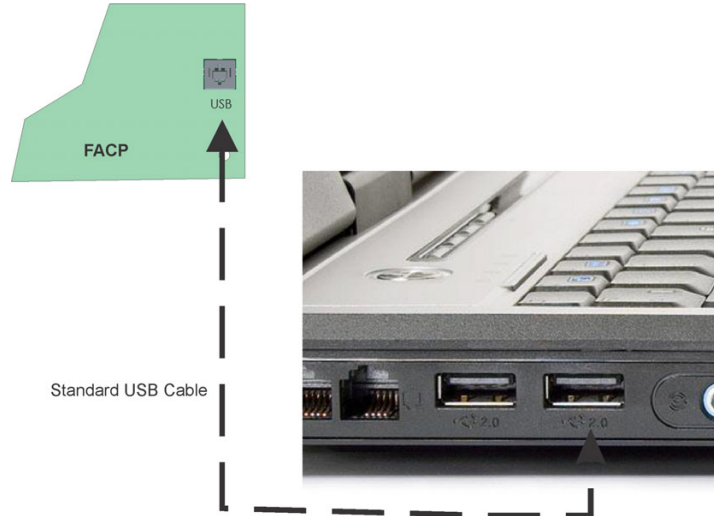

Figure 11.8 USB Cable Connections

3. Run the Voice Message Load software.
4. Select “Read from Panel” to read a message and store onto your hard drive, or “Write to Panel” to transfer a .SKE formatted message to the panel.
5. Select the appropriate message location you wish to read/write.
6. Enter the file name you wish to transfer (Press “Browse” to display a list of files.)
7. Press “Start” to start the transfer.

11.9 Network Paging

For Network Paging Network paging allows live voice paging between panels across the network. The ECS-NVCM, Network Voice Control Module, is needed for network paging. For more information see ECS-Series installation manual P/N 151455.

The network paging source panel is the panel in the network that the microphone network paging audio is originating from. One panel in the network can be the source panel at a time.

A network paging destination panel is a panel in the network that is receiving the network paging. Many panels can be selected as a destination panel for the network paging. Network paging functions as an all call on the destination panel(s) - all speaker circuits will be activated with the network paging audio on a destination panel.the following need to be considered:

Priority

1. Local microphone is higher priority than network paging (a user can page from their local panel even if the local panel is currently receiving a network voice page).
2. Network Paging is higher priority than alarm and alert messages/tones
3. Network paging uses a VBus channel. In a dual channel system, network paging will use either VBus 1 or VBus 2. If both buses are in use, network paging will overtake one of them.

Configuration

1. The ECS-NVCM Select Switches need to be programmed for network paging.
 - Program the switches to select one or more panels as destination panels.
 - Each switch can only be programmed for either output group activation or network paging activation.
2. To use network paging: Cue the microphone and press the Select Switch(es) that correspond to the panel(s) desired to receive network paging
 - Only one panel can source network paging at a time. The first panel to activate network paging is the source until that panel discontinues use of network paging
3. The panel that is the Network Paging source will continue to play any alarms that are active as long as the alarm circuits aren't outputting the microphone page

Section 12: Reporting

This section lists receivers that are compatible with this control panel, and the reporting codes sent by the control panel for SIA and Contact ID formats.

12.1 Receivers Compatible with the Control Panel

Table 12.1 shows receivers compatible with the control panel.

Manufacturer	Model	Format
Silent Knight by Honeywell	Model 9800	SIA and Contact ID
	Model 9000 (SIA formats)	SIA
Honeywell Security	AlarmNet 7810-ir	IP and Cellular Receiver, Contact ID only
Ademco	MX8000	SIA and Contact ID
Ademco	Model 685 (Contact ID)	Contact ID
Sur-Gard	SG-MLR2-DG (V. 1.64 or higher)	SIA and Contact ID
Osborne Hoffman	Quickalert	SIA and Contact ID

Table 12.1 Receivers Compatible with the Control Panel

Event Description	SIA Reporting Format				Contact ID Reporting Format			
	Module ID # (If Any)	SIA Event Codes	Parameter	SIA IFP-2100/ECS	Qualifier	Event Code	Group #	Contact #
				Fixed Length Format NN - panel ID XX- SBUS ID ZZZ- Zone # PPPP- Point # GGG- Group # E- Emergency # RRRR-Receiver #				
System Events	System Events are reported when either "Report by Point" or Report by Zone is selected							
AC power low trouble		AT	0	ATNN000000	1	301	00	000
AC power low trouble restore		AR	0	ARNN000000	3	301	00	000
Auto dialer test communications trouble line 1		YC	1	YCNN000001	1	350	Receiver #	001
Auto dialer test communications trouble line 1 restore		YK	1	YKNN000001	3	350	Receiver #	001
Auto dialer test communications trouble line 2		YC	2	YCNN000002	1	350	Receiver #	002
Auto dialer test communications trouble line 2 restore		YK	2	YKNN000002	3	350	Receiver #	002
Automatic test normal		RP	0	RPNN000000	1	602	00	000
Automatic test off normal		RY	0	RYNN000000	1	608	00	000
Battery voltage trouble		YT	Exp. ID	YTNNXX0000	1	302	Exp. ID	000
Battery voltage trouble restore		YR	Exp. ID	YRNNXX0000	3	302	Exp. ID	000
Date changed event		JD	0	JDNN000000	1	625	00	000
ECS Reset		OR	1	ORNN000001	1	401	00	001
Emergency System Overridden		QS	0	QSNN000000	1	244	00	000
Emergency System Overridden Restore		QR	0	QRNN000000	3	244	00	000
Fire drill has begun		FI	0	FINN000000	1	604	00	000
Fire drill has ended		FK	0	FKNN000000	3	604	00	000
F1 Mapping Inhibited		FT	2001	FTNN002001	1	570	00	001
F1 Mapping Inhibited Restoral		FJ	2001	FJNN002001	3	570	00	001
F2 Mapping Inhibited		FT	2002	FTNN002002	1	570	00	002
F2 Mapping Inhibited Restoral		FJ	2002	FJNN002002	3	570	00	002

Table 12.3 Reporting Formats Table

	SIA Reporting Format				Contact ID Reporting Format			
	SIA pi Modifier			SIA IFF-2100/ECS	Qualifier	Event Code	Group #	Contact #
Event Description	Module ID # (If Any)	SIA Event Codes	Parameter	Fixed Length Format NN - panel ID XX- SBUS ID ZZZ- Zone # PPPP- Point # GGG- Group # E- Emergency # RRRR-Receiver #				
F3 Mapping Inhibited		FT	2003	FTNN002003	1	570	00	003
F3 Mapping Inhibited Restoral		FJ	2003	FJNN002003	3	570	00	003
F4 Mapping Inhibited		FT	2004	FTNN002004	1	570	00	004
F4 Mapping Inhibited Restoral		FJ	2004	FJNN002004	3	570	00	004
Fire Reset		OR	0	ORNN000000	1	401	00	000
Fire System Overridden		FS	0	FSNN000000	1	245	00	000
Fire System Override Restore		FR	0	FRNN000000	3	245	00	000
Ground fault condition trouble		YP	Exp. ID	YPNNXX0000	1	310	Exp. ID	000
Ground fault condition trouble restore		YQ	Exp. ID	YQNNXX0000	3	310	Exp. ID	000
Initial power up		RR	0	RRNN000000	1	305	00	000
Local programming aborted or ended with errors		LU	0	LUNN000000	1	628	00	000
Local programming begin		LB	0	LBNN000000	1	627	00	000
Local programming ended normally		LS	0	LSNN000000	1	628	00	000
Network node trouble (panel missing)		EM	Panel ID	EMNNNN0000	1	334	Panel ID	000
Network node trouble restore (panel no longer missing)		EN	Panel ID	ENNNNN0000	3	334	Panel ID	000
OPG Inhibit Trouble		FT	Group # + 1000	FTNN001GGG	1	320	00	Group #
OPG Inhibit Trouble Restore		FJ	Group # + 1000	FJNN001GGG	3	320	00	Group #
OPG Inhibit of Releasing Group		SS	Group # + 1000	SSNN001GGG	1	203	00	Group #
OPG Inhibit of Releasing Group Restore		SR	Group # + 1000	SRNN001GGG	3	203	00	Group #
Phone line 1 trouble detected		LT	1	LTNN000001	1	351	00	000
Phone line 1 trouble restore		LR	1	LRNN000001	3	351	00	000
Phone line 2 trouble detected		LT	2	LTNN000002	1	352	00	000
Phone line 2 trouble restore		LR	2	LRNN000002	3	352	00	000
Printer is off-line trouble		VZ	Exp. ID	VZNNXX0000	1	336	Exp. ID	000
Printer is off-line trouble restore		VY	Exp. ID	VYNNXX0000	3	336	Exp. ID	000
Printer is out of paper trouble		VO	Exp. ID	VONNXX0000	1	335	Exp. ID	000
Printer is out of paper trouble restore		VI	Exp. ID	VINNXX0000	3	335	Exp. ID	000
Releasing Notif/Control Circuit Disabled	pi Exp. ID	SS	Point #	SSNNXXPPPP	1	203	Exp. ID	Point #
Releasing Notif/Control Circuit enabled	pi Exp. ID	SR	Point #	SRNNXXPPPP	3	203	Exp. ID	Point #
Remote programming aborted or ended with errors		RU	0	RUNN000000	1	413	00	000
Remote programming ended normally		RS	0	RSNN000000	1	412	00	000
Repeater ground fault trouble		EM	0103	EMNN000103	1	334	Panel ID	103

Table 12.3 Reporting Formats Table

	SIA Reporting Format				Contact ID Reporting Format			
	SIA pi Modifier			SIA IFP-2100/ECS	Qualifier	Event Code	Group #	Contact #
Event Description	Module ID # (If Any)	SIA Event Codes	Parameter	Fixed Length Format NN - panel ID XX- SBUS ID ZZZ- Zone # PPPP- Point # GGG- Group # E- Emergency # RRRR-Receiver #				
Repeater ground fault trouble restore		EN	0103	ENNN000103	3	334	Panel ID	103
Repeater missing trouble		EM	0100	EMNN000100	1	334	Panel ID	100
Repeater missing trouble restore		EN	0100	ENNN000100	3	334	Panel ID	100
Repeater Rx1 communication trouble		EM	0101	EMNN000101	1	334	Panel ID	101
Repeater Rx1 communication trouble restore		EN	0101	ENNN000101	3	334	Panel ID	101
Repeater Rx2 communication trouble		EM	0102	EMNN000102	1	334	Panel ID	102
Repeater Rx2 communication trouble restore		EN	0102	ENNN000102	3	334	Panel ID	102
SBUS Class A supervision lost		ET	Exp. ID	ETNNXX0000	1	333	Exp. ID	000
SBUS Class A supervision restore		ER	Exp. ID	ERNNXX0000	3	333	Exp. ID	000
SBUS expander trouble		ET	Exp. ID	ETNNXX0000	1	333	Exp. ID	000
SBUS expander trouble restore		ER	Exp. ID	ERNNXX0000	3	333	Exp. ID	000
SLC class A supervision trouble		ET	Exp. ID	ETNNXX0000	1	331	Exp. ID	000
SLC class A supervision trouble restore		ER	Exp. ID	ERNNXX0000	3	331	Exp. ID	000
SLC programming ended, system active		TE	0	TENN000000	3	607	00	000
SLC programming started, system shut down		TS	0	TSNN000000	1	607	00	000
SLC short circuit trouble		ET	Exp. ID	ETNNXX0000	1	332	Exp. ID	000
SLC short circuit trouble restore		ER	Exp. ID	ERNNXX0000	3	332	Exp. ID	000
Time changed event		JT	0	JTNN000000	1	625	00	000
Unable to report to account trouble		RT	Receiver #	RTNN00RRRR	1	354	00	Receiver #
Unable to report to account trouble restore		YK	Receiver #	YKNN00RRRR	3	354	00	Receiver #
User access code changed		JV	0	JVNN000000	1	602	00	000
User initiated manual dialer test		RX	0	RXNN000000	1	601	00	000
Walk test begin		TS	0	TSNN000000	1	607	00	000
Walk test end		TE	0	TENN000000	3	607	00	000
Table 12.2 Zone Events	Note: Zone events are reported only when "Report by Zone" is selected							
Auxiliary power trouble		FT	0000	FTNN000000	1	320	00	000
Auxiliary power trouble restore		FJ	0000	FJNN000000	3	320	00	000
CO Detector Alarm		GA	Zone #	GANN000ZZZ	1	162	00	Zone #
CO Detector Alarm Restore		GH	Zone #	GHNN000ZZZ	3	162	00	Zone #
CO Detector Supervisory Alarm		GS	Zone #	GSNN000ZZZ	1	200	00	Zone #
CO Detector Supervisory Alarm Restore		GR	Zone #	GRNN000ZZZ	3	200	00	Zone #
CO Detector Trouble		GT	Zone #	GTNN000ZZZ	1	373	00	Zone #
CO Detector Trouble Restore		GJ	Zone #	GJNN000ZZZ	3	373	00	Zone #

Table 12.3 Reporting Formats Table

	SIA Reporting Format				Contact ID Reporting Format			
	SIA pi Modifier			SIA IFP-2100/ECS	Qualifier	Event Code	Group #	Contact #
Event Description	Module ID # (If Any)	SIA Event Codes	Parameter	Fixed Length Format NN - panel ID XX- SBUS ID ZZZ- Zone # PPPP- Point # GGG- Group # E- Emergency # RRRR-Receiver #				
Detector Alarm		FA	Zone #	FANN000ZZZ	1	110	00	Zone #
Detector Alarm Restore		FH	Zone #	FHNN000ZZZ	3	110	00	Zone #
Detector trouble		FT	Zone #	FTNN000ZZZ	1	373	00	Zone #
Detector trouble restore		FJ	Zone #	FJNN000ZZZ	3	373	00	Zone #
ECS Switch Trouble		QT	0	QTNN000000	1	242	00	000
ECS Switch Trouble Restore		QJ	0	QJNN000000	3	242	00	000
ECS Supervisory/Tamper Alarm		QS	0	QSNN000000	1	241	00	000
ECS Supervisory/Tamper Alarm Restore		QR	0	QRNN000000	3	241	00	000
ECS Output Group Trouble		QT	Group # +1000	QTNN001GGG	1	320	00	Group #
ECS Output Group Trouble Restore		QJ	Group # +1000	QJNN001GGG	3	320	00	Group #
External Reset/Silence/Fire Drill switch trouble		UT	0000	UTNN000000	1	373	00	000
External Reset/Silence/Fire Drill switch trouble restore		UJ	0000	UJNN000000	3	373	00	000
LOC Mic Activated ECS Alarm		QA	0	QANN000000	1	220	00	000
LOC Mic Activated ECS Alarm Restore		QH	0	QHNN000000	3	220	00	000
LOC/Point ECS # Alarm		QA	Emergency #	QANN0E0000	1	220 + Emergency #	00	000
LOC/Point ECS # Alarm Restore		QH	Emergency #	QHNN0E0000	3	220 + Emergency #	00	000
Manual pull switch alarm		FA	Zone #	FANN000ZZZ	1	115	00	Zone #
Manual pull switch alarm restore		FH	Zone #	FHNN000ZZZ	3	115	00	Zone #
Manual pull switch trouble		FT	Zone #	FTNN000ZZZ	1	373	00	Zone #
Manual pull switch trouble restore		FJ	Zone #	FJNN000ZZZ	3	373	00	Zone #
Notification output trouble		FT	Group # + 1000	FTNN001GGG	1	320	00	Group #
Notification output trouble restore		FJ	Group # + 1000	FJNN001GGG	3	320	00	Group #
Positive Alarm Sequence acknowledge switch trouble		FT	Zone #	FTNN000ZZZ	1	373	00	Zone #
Positive Alarm Sequence acknowledge switch trouble restore		FJ	Zone #	FJNN000ZZZ	3	373	00	Zone #
SLC LED Module trouble		ET	0000	ETNN000000	1	333	00	000
SLC LED Module trouble restore		ER	0000	ERNN000000	3	333	00	000
Status Point Types Trouble		UT	0	UTNN000000	1	379	00	000
Status Point Types Trouble Restore		UJ	0	UJNN000000	3	379	00	000
Supervisory Detector Alarm		FS	Zone #	FSNN000ZZZ	1	200	00	Zone #
Supervisory Detector Alarm Restore		FR	Zone #	FRNN000ZZZ	3	200	00	Zone #

Table 12.3 Reporting Formats Table

	SIA Reporting Format				Contact ID Reporting Format			
	SIA pi Modifier			SIA IFP-2100/ECS	Qualifier	Event Code	Group #	Contact #
Event Description	Module ID # (If Any)	SIA Event Codes	Parameter	Fixed Length Format NN - panel ID XX- SBUS ID ZZZ- Zone # PPPP- Point # GGG- Group # E- Emergency # RRRR-Receiver #				
Supervisory/Tamper Alarm		FS	Zone #	FSNN000ZZZ	1	200	00	Zone #
Supervisory/Tamper alarm condition restore		FR	Zone #	FRNN000ZZZ	3	200	00	Zone #
Supervisory/Tamper switch trouble		FT	Zone #	FTNN000ZZZ	1	373	00	Zone #
Supervisory/Tamper switch trouble restore		FJ	Zone #	FJNN000ZZZ	3	373	00	Zone #
System-based AUX1 switch alarm		UA	1000	UANN001000	1	140	01	000
System-based AUX1 switch alarm restore		UH	1000	UHNN001000	3	140	01	000
System-based AUX1 switch trouble		UT	1000	UTNN001000	1	373	01	000
System-based AUX1 switch trouble restore		UJ	1000	UJNN001000	3	373	01	000
System-based AUX2 switch alarm		UA	2000	UANN002000	1	140	02	000
System-based AUX2 switch alarm restore		UH	2000	UHNN002000	3	140	02	000
System-based AUX2 switch trouble		UT	2000	UTNN002000	1	373	02	000
System-based AUX2 switch trouble restore		UJ	2000	UJNN002000	3	373	02	000
Voice Aux ECS 1 Alarm		UA	3	UANN003000	1	171	00	000
Voice Aux ECS 1 Alarm Restore		UH	3	UHNN003000	3	171	00	000
Voice Aux ECS 2 Alarm		UA	4	UANN004000	1	172	00	000
Voice Aux ECS 2 Alarm Restore		UH	4	UHNN004000	3	172	00	000
Voice Aux ECS 3 Alarm		UA	5	UANN005000	1	173	00	000
Voice Aux ECS 3 Alarm Restore		UH	5	UHNN005000	3	173	00	000
Voice Aux ECS 4 Alarm		UA	6	UANN006000	1	174	00	000
Voice Aux ECS 4 Alarm Restore		UH	6	UHNN006000	3	174	00	000
Water flow switch alarm		SA	Zone #	SANN000ZZZ	1	113	00	Zone #
Water flow switch alarm Restore		SH	Zone #	SHNN000ZZZ	3	113	00	Zone #
Water flow switch trouble		ST	Zone #	STNN000ZZZ	1	373	00	Zone #
Water flow switch trouble Restore		SJ	Zone #	SJNN000ZZZ	3	373	00	Zone #
Zone-based AUX1 switch alarm		UA	Zone # + 1000	UANN001ZZZ	1	140	01	Zone #
Zone-based AUX1 switch alarm restore		UH	Zone # + 1000	UHNN001ZZZ	3	140	01	Zone #
Zone-based AUX1 switch trouble		UT	Zone # + 1000	UTNN001ZZZ	1	373	01	Zone #
Zone-based AUX1 switch trouble restore		UJ	Zone # + 1000	UJNN001ZZZ	3	373	01	Zone #
Zone-based AUX2 switch alarm		UA	Zone # + 2000	UANN002ZZZ	1	140	02	Zone #

Table 12.3 Reporting Formats Table

	SIA Reporting Format				Contact ID Reporting Format			
	SIA pi Modifier			SIA IFF-2100/ECS	Qualifier	Event Code	Group #	Contact #
Event Description	Module ID # (If Any)	SIA Event Codes	Parameter	Fixed Length Format NN - panel ID XX- SBUS ID ZZZ- Zone # PPPP- Point # GGG- Group # E- Emergency # RRRR-Receiver #				
Zone-based AUX2 switch alarm restore		UH	Zone # + 2000	UHNN002ZZZ	3	140	02	Zone #
Zone-based AUX2 switch trouble		UT	Zone # + 2000	UTNN002ZZZ	1	373	02	Zone #
Zone-based AUX2 switch trouble restore		UJ	Zone # + 2000	UJNN002ZZZ	3	373	02	Zone #
Point Event: For IDP or SK devices, sensors 1–159 are reported as Points 1–159, modules 1–159 are reported as Points 201–359.								
An unexpected SLC device has been detected	pi Exp. ID	XE	Point #	XENNXXPPPP	1	380	Exp. ID	Point #
An unexpected SLC device has been removed	pi Exp. ID	XI	Point #	XINNXXPPPP	3	380	Exp. ID	Point #
Auxiliary power disabled	pi Exp. ID	FB	Point #	FBNNXXPPPP	1	571	Exp. ID	Point #
Auxiliary power enabled	pi Exp. ID	FU	Point #	FUNNXXPPPP	3	571	Exp. ID	Point #
Auxiliary power Trouble	pi Exp. ID	FT	Point #	FTNNXXPPPP	1	320	Exp. ID	Point #
Auxiliary power trouble restore	pi Exp. ID	FJ	Point #	FJNNXXPPPP	3	320	Exp. ID	Point #
Background Music Switch is Trouble	pi Exp. ID	UT	Point #	UTNNXXPPPP	1	379	Exp. ID	Point #
Background Music Switch is Trouble Restored	pi Exp. ID	UJ	Point #	UJNNXXPPPP	3	379	Exp. ID	Point #
Background Music Switch is Disabled	pi Exp. ID	UB	Point #	UBNNXXPPPP	1	580	Exp. ID	Point #
Background Music Switch is Enabled	pi Exp. ID	UU	Point #	UUNNXXPPPP	3	580	Exp. ID	Point #
CO Detector Trouble	pi Exp. ID	GT	Point #	GTNNXXPPPP	1	373	Exp. ID	Point #
CO Detector Trouble Restore	pi Exp. ID	GJ	Point #	GJNNXXPPPP	3	373	Exp. ID	Point #
CO Detector Disabled	pi Exp. ID	GB	Point #	GBNNXXPPPP	1	571	Exp. ID	Point #
CO Detector Enabled	pi Exp. ID	GU	Point #	GUNNXXPPPP	3	571	Exp. ID	Point #
Detector Alarm	pi Exp. ID	FA	Point #	FANNXXPPPP	1	110	Exp. ID	Point #
Detector Alarm restore	pi Exp. ID	FH	Point #	FHNNXXPPPP	3	110	Exp. ID	Point #
Detector Disabled	pi Exp. ID	FB	Point #	FBNNXXPPPP	1	571	Exp. ID	Point #
Detector Enabled	pi Exp. ID	FU	Point #	FUNNXXPPPP	3	571	Exp. ID	Point #
Detector Trouble	pi Exp. ID	FT	Point #	FTNNXXPPPP	1	373	Exp. ID	Point #
Detector Trouble restore	pi Exp. ID	FJ	Point #	FJNNXXPPPP	3	373	Exp. ID	Point #
Detector CO Alarm	pi Exp. ID	GA	Point #	GANNXXPPPP	1	162	Exp. ID	Point #
Detector CO Alarm Restore	pi Exp. ID	GH	Point #	GHNNXXPPPP	3	162	Exp. ID	Point #
Detector CO Supervisory Alarm	pi Exp. ID	GS	Point #	GSNNXXPPPP	1	200	Exp. ID	Point #
Detector CO Supervisory Alarm Restore	pi Exp. ID	GR	Point #	GRNNXXPPPP	3	200	Exp. ID	Point #
ECS Alarm # Point Alarm	pi Exp. ID	QA	(EPPP)E - Emergency # PPP - Point #	QANNXXEPPP	1	220 + Emergency #	Exp. ID	Point #

Table 12.3 Reporting Formats Table

	SIA Reporting Format				Contact ID Reporting Format			
	SIA pi Modifier			SIA IFF-2100/ECS	Qualifier	Event Code	Group #	Contact #
Event Description	Module ID # (If Any)	SIA Event Codes	Parameter	Fixed Length Format NN - panel ID XX- SBUS ID ZZZ- Zone # PPPP- Point # GGG- Group # E- Emergency # RRRR-Receiver #				
ECS Alarm # Point Alarm Restore	pi Exp. ID	QH	(EPPP)E - Emergency # PPP - Point #	QHNNXXEPPP	3	220 + Emergency #	Exp. ID	Point #
ECS Alarm # Point Trouble	pi Exp. ID	QT	Point #	QTNNXXPPPP	1	242	Exp. ID	Point #
ECS Alarm # Point Trouble Restore	pi Exp. ID	QJ	Point #	QJNNXXPPPP	3	242	Exp. ID	Point #
ECS Alarm # Point Disabled	pi Exp. ID	QB	Point #	QBNNXXPPPP	1	243	Exp. ID	Point #
ECS Alarm # Point Enabled	pi Exp. ID	QU	Point #	QUNNXXPPPP	3	243	Exp. ID	Point #
ECS Supervisory/Tamper Alarm	pi Exp. ID	QS	Point #	QSNNXXPPPP	1	241	Exp. ID	Point #
ECS Supervisory/Tamper Alarm Restore	pi Exp. ID	QR	Point #	QRNNXXPPPP	3	241	Exp. ID	Point #
ECS Supervisory/Tamper Trouble	pi Exp. ID	QT	Point #	QTNNXXPPPP	1	242	Exp. ID	Point #
ECS Supervisory/Tamper Trouble Restore	pi Exp. ID	QJ	Point #	QJNNXXPPPP	3	242	Exp. ID	Point #
ECS Supervisory/Tamper Disabled	pi Exp. ID	QB	Point #	QBNNXXPPPP	1	243	Exp. ID	Point #
ECS Supervisory/Tamper Enabled	pi Exp. ID	QU	Point #	QUNNXXPPPP	3	243	Exp. ID	Point #
ECS NAC Trouble	pi Exp. ID	QT	Point #	QTNNXXPPPP	1	320	Exp. ID	Point #
ECS NAC Trouble Restored	pi Exp. ID	QJ	Point #	QJNNXXPPPP	3	320	Exp. ID	Point #
ECS Control Circuit Trouble	pi Exp. ID	QT	Point #	QTNNXXPPPP	1	320	Exp. ID	Point #
ECS Control Circuit Trouble Restored	pi Exp. ID	QJ	Point #	QJNNXXPPPP	3	320	Exp. ID	Point #
ECS Relay Trouble	pi Exp. ID	QT	Point #	QTNNXXPPPP	1	320	Exp. ID	Point #
ECS Relay Trouble Restored	pi Exp. ID	QJ	Point #	QJNNXXPPPP	3	320	Exp. ID	Point #
ECS Notification Trouble	pi Exp. ID	QT	Point #	QTNNXXPPPP	1	320	Exp. ID	Point #
ECS Notification Trouble Restored	pi Exp. ID	QJ	Point #	QJNNXXPPPP	3	320	Exp. ID	Point #
External Reset/Silence/Fire Drill switch disabled	pi Exp. ID	UB	Point #	UBNNXXPPPP	1	571	Exp. ID	Point #
External Reset/Silence/Fire Drill switch enabled	pi Exp. ID	UU	Point #	UUNNXXPPPP	3	571	Exp. ID	Point #
External Reset/Silence/Fire Drill switch trouble	pi Exp. ID	UT	Point #	UTNNXXPPPP	1	373	Exp. ID	Point #
External Reset/Silence/Fire Drill switch trouble restore	pi Exp. ID	UJ	Point #	UJNNXXPPPP	3	373	Exp. ID	Point #
Interlock switch alarm (Water Release Zone)	pi Exp. ID	FA	Point #	FANNXXPPPP	1	110	Exp. ID	Point #
Interlock switch alarm restore (Water Release Zone)	pi Exp. ID	FH	Point #	FHNNXXPPPP	3	110	Exp. ID	Point #
Interlock switch disabled	pi Exp. ID	FB	Point #	FBNNXXPPPP	1	571	Exp. ID	Point #
Interlock switch enabled	pi Exp. ID	FU	Point #	FUNNXXPPPP	3	571	Exp. ID	Point #

Table 12.3 Reporting Formats Table

	SIA Reporting Format				Contact ID Reporting Format			
	SIA pi Modifier			SIA IFF-2100/ECS	Qualifier	Event Code	Group #	Contact #
Event Description	Module ID # (If Any)	SIA Event Codes	Parameter	Fixed Length Format NN - panel ID XX- SBUS ID ZZZ- Zone # PPPP- Point # GGG- Group # E- Emergency # RRRR-Receiver #				
Interlock switch trouble (Water Release Zone)	pi Exp. ID	FT	Point #	FTNNXXPPPP	1	373	Exp. ID	Point #
Interlock switch trouble restore (Water Release Zone)	pi Exp. ID	FJ	Point #	FJNNXXPPPP	3	373	Exp. ID	Point #
LOC Mic Activated ECS Alarm	pi Exp. ID	QA	0	QANNXX0000	1	220	Exp. ID	000
LOC Mic Activated ECS Alarm Restore	pi Exp. ID	QH	0	QHNNXX0000	3	220	Exp. ID	000
LOC ECS # Alarm	pi Exp. ID	QA	Emergency #	QANNXXE000	1	220 + Emergency #	Exp. ID	000
LOC ECS # Alarm Restore	pi Exp. ID	QH	Emergency #	QHNNXXE000	3	220 + Emergency #	Exp. ID	000
Manual pull switch alarm	pi Exp. ID	FA	Point #	FANNXXPPPP	1	115	Exp. ID	Point #
Manual pull switch alarm restore	pi Exp. ID	FH	Point #	FHNNXXPPPP	3	115	Exp. ID	Point #
Manual pull switch disabled	pi Exp. ID	FB	Point #	FBNNXXPPPP	1	571	Exp. ID	Point #
Manual pull switch enabled	pi Exp. ID	FU	Point #	FUNNXXPPPP	3	571	Exp. ID	Point #
Manual pull switch trouble	pi Exp. ID	FT	Point #	FTNNXXPPPP	1	373	Exp. ID	Point #
Manual pull switch trouble restore	pi Exp. ID	FJ	Point #	FJNNXXPPPP	3	373	Exp. ID	Point #
Manual release switch alarm (Water Release Zone)	pi Exp. ID	FA	Point #	FANNXXPPPP	1	110	Exp. ID	Point #
Manual release switch alarm restore (Water Release Zone)	pi Exp. ID	FH	Point #	FHNNXXPPPP	3	110	Exp. ID	Point #
Manual release switch disabled	pi Exp. ID	FB	Point #	FBNNXXPPPP	1	571	Exp. ID	Point #
Manual release switch enabled	pi Exp. ID	FU	Point #	FUNNXXPPPP	3	571	Exp. ID	Point #
Manual release switch trouble (Water Release Zone)	pi Exp. ID	FT	Point #	FTNNXXPPPP	1	373	Exp. ID	Point #
Manual release switch trouble restore (Water Release Zone)	pi Exp. ID	FJ	Point #	FJNNXXPPPP	3	373	Exp. ID	Point #
Notification output point disabled	pi Exp. ID	FB	Point #	FBNNXXPPPP	1	571	Exp. ID	Point #
Notification output point enabled	pi Exp. ID	FU	Point #	FUNNXXPPPP	3	571	Exp. ID	Point #
Notification output point trouble	pi Exp. ID	FT	Point #	FTNNXXPPPP	1	320	Exp. ID	Point #
Notification output point trouble restore	pi Exp. ID	FJ	Point #	FJNNXXPPPP	3	320	Exp. ID	Point #
Positive Alarm Sequence acknowledge switch disabled	pi Exp. ID	FB	Point #	FBNNXXPPPP	1	571	Exp. ID	Point #
Positive Alarm Sequence acknowledge switch enabled	pi Exp. ID	FU	Point #	FUNNXXPPPP	3	571	Exp. ID	Point #
Positive Alarm Sequence acknowledge switch trouble	pi Exp. ID	FT	Point #	FTNNXXPPPP	1	373	Exp. ID	Point #
Positive Alarm Sequence acknowledge switch trouble restore	pi Exp. ID	FJ	Point #	FJNNXXPPPP	3	373	Exp. ID	Point #
Status Point Trouble	pi Exp. ID	UT	Point #	UTNNXXPPPP	1	379	Exp. ID	Point #
Status Point Trouble Restored	pi Exp. ID	UJ	Point #	UJNNXXPPPP	3	379	Exp. ID	Point #
Status Point is Disabled	pi Exp. ID	UB	Point #	UBNNXXPPPP	1	580	Exp. ID	Point #
Status Point is Enabled	pi Exp. ID	UU	Point #	UUNNXXPPPP	3	580	Exp. ID	Point #

Table 12.3 Reporting Formats Table

	SIA Reporting Format				Contact ID Reporting Format			
	SIA pi Modifier			SIA IFF-2100/ECS	Qualifier	Event Code	Group #	Contact #
Event Description	Module ID # (If Any)	SIA Event Codes	Parameter	Fixed Length Format NN - panel ID XX- SBUS ID ZZZ- Zone # PPPP- Point # GGG- Group # E- Emergency # RRRR-Receiver #				
Supervisory/Tamper Alarm	pi Exp. ID	FS	Point #	FSNNXXPPPP	1	200	Exp. ID	Point #
Supervisory/Tamper Alarm Restore	pi Exp. ID	FR	Point #	FRNNXXPPPP	3	200	Exp. ID	Point #
Supervisory/Tamper point disabled	pi Exp. ID	FB	Point #	FBNNXXPPPP	1	571	Exp. ID	Point #
Supervisory/Tamper point enabled	pi Exp. ID	FU	Point #	FUNNXXPPPP	3	571	Exp. ID	Point #
Supervisory/Tamper point trouble	pi Exp. ID	FT	Point #	FTNNXXPPPP	1	373	Exp. ID	Point #
Supervisory/Tamper point trouble restore	pi Exp. ID	FJ	Point #	FJNNXXPPPP	3	373	Exp. ID	Point #
System-based AUX1 switch alarm	pi Exp. ID	UA	Point #	UANNXXPPPP	1	140	Exp. ID	Point #
System-based AUX1 switch alarm restore	pi Exp. ID	UH	Point #	UHNNXXPPPP	3	140	Exp. ID	Point #
System-based AUX1 switch disabled	pi Exp. ID	UB	Point #	UBNNXXPPPP	1	571	Exp. ID	Point #
System-based AUX1 switch enabled	pi Exp. ID	UU	Point #	UUNNXXPPPP	3	571	Exp. ID	Point #
System-based AUX1 switch trouble	pi Exp. ID	UT	Point #	UTNNXXPPPP	1	373	Exp. ID	Point #
System-based AUX1 switch trouble restore	pi Exp. ID	UJ	Point #	UJNNXXPPPP	3	373	Exp. ID	Point #
System-based AUX2 switch alarm	pi Exp. ID	UA	Point #	UANNXXPPPP	1	140	Exp. ID	Point #
System-based AUX2 switch alarm restore	pi Exp. ID	UH	Point #	UHNNXXPPPP	3	140	Exp. ID	Point #
System-based AUX2 switch disabled	pi Exp. ID	UB	Point #	UBNNXXPPPP	1	571	Exp. ID	Point #
System-based AUX2 switch enabled	pi Exp. ID	UU	Point #	UUNNXXPPPP	3	571	Exp. ID	Point #
System-based AUX2 switch trouble	pi Exp. ID	UT	Point #	UTNNXXPPPP	1	373	Exp. ID	Point #
System-based AUX2 switch trouble restore	pi Exp. ID	UJ	Point #	UJNNXXPPPP	3	373	Exp. ID	Point #
Voice Aux ECS 1 Point Alarm	pi Exp. ID	UA	(3PPP) PPP - Point #	UANNXX3PPP	1	171	Exp. ID	Point #
Voice Aux ECS 1 Point Alarm Restore	pi Exp. ID	UH	(3PPP) PPP - Point #	UHNNXX3PPP	3	171	Exp. ID	Point #
Voice Aux ECS 2 Point Alarm	pi Exp. ID	UA	(4PPP) PPP - Point #	UANNXX4PPP	1	172	Exp. ID	Point #
Voice Aux ECS 2 Point Alarm Restore	pi Exp. ID	UH	(4PPP) PPP - Point #	UHNNXX4PPP	3	172	Exp. ID	Point #

Table 12.3 Reporting Formats Table

Event Description	SIA Reporting Format				Contact ID Reporting Format			
	SIA pi Modifier		SIA IFF-2100/ECS		Qualifier	Event Code	Group #	Contact #
Module ID # (If Any)	SIA Event Codes	Parameter	Fixed Length Format NN - panel ID XX- SBUS ID ZZZ- Zone # PPPP- Point # GGG- Group # E- Emergency # RRRR-Receiver #					
Voice Aux ECS 3 Point Alarm	pi Exp. ID	UA	(5PPP) PPP - Point #	UANNXX5PPP	1	173	Exp. ID	Point #
Voice Aux ECS 3 Point Alarm Restore	pi Exp. ID	UH	(5PPP) PPP - Point #	UHNNXX5PPP	3	173	Exp. ID	Point #
Voice Aux ECS 4 Point Alarm	pi Exp. ID	UA	(6PPP) PPP - Point #	UANNXX6PPP	1	174	Exp. ID	Point #
Voice Aux ECS 4 Point Alarm Restore	pi Exp. ID	UH	(6PPP) PPP - Point #	UHNNXX6PPP	3	174	Exp. ID	Point #
Voice Aux ECS Point Trouble	pi Exp. ID	UT	Point #	UTNNXXPPPP	1	379	Exp. ID	Point #
Voice Aux ECS Point Trouble Restore	pi Exp. ID	UJ	Point #	UJNNXXPPPP	3	379	Exp. ID	Point #
Voice Aux ECS Point Disabled	pi Exp. ID	UB	Point #	UBNNXXPPPP	1	580	Exp. ID	Point #
Voice Aux ECS Point Enabled	pi Exp. ID	UU	Point #	UUNNXXPPPP	3	580	Exp. ID	Point #
Voice Aux Status 1 Switch is Trouble	pi Exp. ID	UT	Point #	UTNNXXPPPP	1	379	Exp. ID	Point #
Voice Aux Status 1 Switch is Trouble Restored	pi Exp. ID	UJ	Point #	UJNNXXPPPP	3	379	Exp. ID	Point #
Voice Aux Status 1 Switch is Disabled	pi Exp. ID	UB	Point #	UBNXXPPPP	1	580	Exp. ID	Point #
Voice Aux Status 1 Switch is Enabled	pi Exp. ID	UU	Point #	UUNXXPPPP	3	580	Exp. ID	Point #
Voice Aux Status 2 Switch is Trouble	pi Exp. ID	UT	Point #	UTNNXXPPPP	1	379	Exp. ID	Point #
Voice Aux Status 2 Switch is Trouble Restored	pi Exp. ID	UJ	Point #	UJNNXXPPPP	3	379	Exp. ID	Point #
Voice Aux Status 2 Switch is Disabled	pi Exp. ID	UB	Point #	UBNNXXPPPP	1	580	Exp. ID	Point #
Voice Aux Status 2 Switch is Enabled	pi Exp. ID	UU	Point #	UUNNXXPPPP	3	580	Exp. ID	Point #
Water flow switch alarm	pi Exp. ID	SA	Point #	SANNXXPPPP	1	113	Exp. ID	Point #
Water flow switch alarm restore	pi Exp. ID	SH	Point #	SHNNXXPPPP	3	113	Exp. ID	Point #
Water flow switch disabled	pi Exp. ID	SB	Point #	SBNNXXPPPP	1	571	Exp. ID	Point #
Water flow switch enabled	pi Exp. ID	SU	Point #	SUNNXXPPPP	3	571	Exp. ID	Point #
Water flow switch trouble	pi Exp. ID	ST	Point #	STNNXXPPPP	1	373	Exp. ID	Point #
Water flow switch trouble restore	pi Exp. ID	SJ	Point #	SJNNXXPPPP	3	373	Exp. ID	Point #
Zone-based AUX1 switch alarm	pi Exp. ID	UA	Point #	UANNXXPPPP	1	140	Exp. ID	Point #
Zone-based AUX1 switch alarm restore	pi Exp. ID	UH	Point #	UHNNXXPPPP	3	140	Exp. ID	Point #
Zone-based AUX1 switch disabled	pi Exp. ID	UB	Point #	UBNNXXPPPP	1	571	Exp. ID	Point #
Zone-based AUX1 switch enabled	pi Exp. ID	UU	Point #	UUNNXXPPPP	3	571	Exp. ID	Point #
Zone-based AUX1 switch trouble	pi Exp. ID	UT	Point #	UTNNXXPPPP	1	373	Exp. ID	Point #

Table 12.3 Reporting Formats Table

	SIA Reporting Format				Contact ID Reporting Format			
	SIA pi Modifier		SIA IFP-2100/ECS		Qualifier	Event Code	Group #	Contact #
Event Description	Module ID # (If Any)	SIA Event Codes	Parameter	Fixed Length Format NN - panel ID XX- SBUS ID ZZZ- Zone # PPPP- Point # GGG- Group # E- Emergency # RRRR-Receiver #				
Zone-based AUX1 switch trouble restore	pi Exp. ID	UJ	Point #	UJNNXXPPPP	3	373	Exp. ID	Point #
Zone-based AUX2 switch alarm	pi Exp. ID	UA	Point #	UANNXXPPPP	1	140	Exp. ID	Point #
Zone-based AUX2 switch alarm restore	pi Exp. ID	UH	Point #	UHNNXXPPPP	3	140	Exp. ID	Point #
Zone-based AUX2 switch disabled	pi Exp. ID	UB	Point #	UBNNXXPPPP	1	571	Exp. ID	Point #
Zone-based AUX2 switch enabled	pi Exp. ID	UU	Point #	UUNNXXPPPP	3	571	Exp. ID	Point #
Zone-based AUX2 switch trouble	pi Exp. ID	UT	Point #	UTNNXXPPPP	1	373	Exp. ID	Point #
Zone-based AUX2 switch trouble restore	pi Exp. ID	UJ	Point #	UJNNXXPPPP	3	373	Exp. ID	Point #
System-based Wireless Gateway Trouble	pi Exp. ID	UT	Point #	UTNNXXPPPP	1	373	Exp. ID	Point #
System-based Wireless Gateway Trouble - restore	pi Exp. ID	UJ	Point #	UJNNXXPPPP	3	373	Exp. ID	Point #
Wireless Gateway Trouble	pi Exp. ID	UT	Point #	UTNNXXPPPP	1	373	Exp. ID	Point #
Wireless Gateway Trouble re-store	pi Exp. ID	UJ	Point #	UJNNXXPPPP	3	373	Exp. ID	Point #

Table 12.3 Reporting Formats Table

12.2 SIA - IntelliKnight / IFP-2100/ECS Panels PI Modifier Reporting:

Events are sent to the central station as a variable length string:

The event format is:

EEZZZZ

Where:

EE Event code (2 characters)

ZZZZ Event parameter (up to four digits – not zero filled)

1. The account number is sent using an account block that is separate from the event block
2. Multiple events can be sent within a single event block. Events are separated by a “/” character.
3. Event parameter can be either a zone, point or module number.
4. When reporting by point is enabled, the communicator uses a “pi” event to supersedes the actual point event to report the module the point is linked to.
5. Panel ID is not sent in the SIA event parameters.

For Example see Table 12.4:

Event	Report Zone/ Point	Panel ID	Module	Zone ZZZZ	Point ZZZZ	Fields Sent	SIA Event Data
Fire Alarm-Zone	Zone	n/a	n/a97	15	n/a	EE-ZZ	FA15
Fire Alarm-Zone	Zone	n/a	n/a	05	n/a	EE-Z	FA5
Fire Alarm-Point	Point	n/a	01	n/a	123	EE-ZZ /EE-ZZZ	pi01/FA123

Table 12.4 SIA- IntelliKnight / IFP-2100/ECS Panels - PI Modifier Reporting Examples

Event	Report Zone/ Point	Panel ID	Module	Zone ZZZZ	Point ZZZZ	Fields Sent	SIA Event Data
Fire Alarm-Point	Point	n/a	33	n/a	203	EE-ZZ /EE-ZZZ	pi11/FA203
Expander Trouble	n/a	n/a	11	n/a	n/a	EE-ZZ	ET11
Auto Test	n/a	n/a	n/a	n/a	n/a	EE-Z	RP0
Battery Trouble-Panel 32	n/a	n/a	98	n/a	n/a	EE-ZZ	YT98
Battery Trouble-Expander 18	n/a	n/a	18	n/a	n/a	EE-ZZ	YT18
SLC Loop Shorted	n/a	n/a	44	n/a	n/a	EE-ZZ	ET44
Program Begin Panel ID=32	n/a	n/a	n/a	n/a	n/a	EE-Z	LB0
Program Begin Panel ID=22	n/a	n/a	n/a	n/a	n/a	EE-Z	LB0
AC Power Loss - Panel 22	n/a	n/a	98	n/a	n/a	EE-Z	AT0
Fire Trouble	Point	n/a	97	n/a	200	EE-ZZ /EE-ZZZ	pi97/FT200
Fire Trouble	Zone	n/a	97	01	n/a	EE-Z	FT1
Fire Trouble-Nac	Point	n/a	98	n/a	Nac Circuit 7	EE-ZZ /EE-Z	pi98/FT7 Z=Pt. #
Fire Trouble-Nac	Zone	n/a	98	n/a	Nac Circuit 7	EE-ZZZ	FT400 ZZZ=OPG#

Table 12.4 SIA- IntelliKnight / IFP-2100/ECS Panels - PI Modifier Reporting Examples

12.3 SIA – IFP-2100/ECS Panel Communicator:

(Differences/additional features are underlined>)

Events are sent to the Central Station Receiver as a fixed length string:

The event format is:

EEPPMMZZZZ

Where

EE Event code (2 characters)

PP Panel number (2 digits – Zero Filled) (valid range from 1 to 64)

MM Module number (2 digits – Zero Filled) (valid range from 1 to 98, typically Module information)

ZZZZ Event parameter (4 digits – Zero Filled) (typically Point, Zone or Circuit information)

1. The Event field will contain 10 digits including the 2 digit event code (EE), 2 digit panel ID (PP), 2 digit Module Number (MM) and a 4 digit Event Parameter (ZZZZ).
2. Based on the actual Event Code, the Module Number or Event Parameter fields might not contain pertinent information. In that case the field will contain zeros.
3. The account number is sent using an account block that is separate from the event block.
4. Multiple events can be sent within a single event block. Events are separated by a “/” character.
5. Event parameter can be a Zone, Point or Circuit Number.
6. “pi” modifier event is not used.
7. Panel can be set to report by either Point or Zone.

For examples see Table 12.5.

Event	Report Zone/ Point	Panel ID PP	Module MM	Zone ZZZZ	Point ZZZZ	Fields Sent	SIA Event Data
Fire Alarm-Zone	Zone	32	n/a	15	n/a	EE-PP-MM-ZZZZ	FA32000015
Fire Alarm-Zone	Zone	32	n/a	05	n/a	EE-PP-MM-ZZZZ	FA32000005
Fire Alarm-Point	Point	32	01	n/a	123	EE-PP-MM-ZZZZ	FA32010123

Table 12.5 IFP-2100/ECS SIA REPORTING EXAMPLES

Fire Alarm-Point	Point	21	33	n/a	203	EE-PP-MM-ZZZZ	FA21330203
Expander Trouble	n/a	15	11	n/a	n/a	EE-PP-MM-ZZZZ	ET15110000
Auto Test	n/a	32	n/a	n/a	n/a	EE-PP-MM-ZZZZ	RP32000000
Battery Trouble-Panel 32	n/a	32	98	n/a	n/a	EE-PP-MM-ZZZZ	YT32980000
Battery Trouble-Expander 18	n/a	32	18	n/a	n/a	EE-PP-MM-ZZZZ	YT32180000
SLC Loop Shorted	n/a	01	44	n/a	n/a	EE-PP-MM-ZZZZ	ET01440000
Program Begin	n/a	32	n/a	n/a	n/a	EE-PP-MM-ZZZZ	LB32000000
Program Begin	n/a	22	n/a	n/a	n/a	EE-PP-MM-ZZZZ	LB22000000
AC Power Loss- Panel 22	n/a	22	98	n/a	n/a	EE-PP-MM-ZZZZ	AT22980000 MM = 00
Fire Trouble	Point	22	97	n/a	200	EE-PP-MM-ZZZZ	FT22970200
Fire Trouble	Zone	22	97	1	n/a	EE-PP-MM-ZZZZ	FT22970001 MM = 00
Fire Trouble-NAC	Point	22	98	n/a	NAC Circuit 7	EE-PP-MM-ZZZZ	FT22980007 ZZZZ=Pt. #
Fire Trouble-NAC	Zone	22	98	n/a	NAC Circuit 7	EE-PP-MM-ZZZZ	FT22980007 ZZZZ=OPG #

Table 12.5 IFP-2100/ECS SIA REPORTING EXAMPLES

Section 13: Testing and Troubleshooting

13.1 Troubleshooting

This section of the manual offers suggestions for troubleshooting hardware problems. Please read this section if you encounter a problem when installing the control panel. If these suggestions do not solve your problem or if you encounter a problem that is not listed here, contact Technical Support at 800-446-6444 for assistance. Common Problems

Problem	Possible Cause / Suggested Actions
Trouble message "DBL ADDR" (Double Address) displays on LCD.	An address has been assigned to more than one detector. Correct the address following the procedure described in Section 7.9 if using SD devices or Section 7.7 if using IDP devices
Auxiliary power or notification circuits have incorrect polarity.	Correct polarity. For notification and auxiliary power circuits: When in alarm or powered, terminals labeled "X" are positive, terminals labeled "O" are negative.
SLC devices are not being recognized (trouble message "Missing" displays).	Check hardware connections. If devices are physically connected, make sure wiring is correct (see Section 7.8 if using SD devices or Section 7.7 if using IDP or SK devices). For 6815 devices, make sure the device connects to the 6815 via the SLC OUT terminals. There can be only one SLC loop on the main panel and on each 6815 module. Do not connect devices to terminals labeled SLC IN.
	Make sure SLC devices have been addressed properly following the procedure described in Section 7.9 if using SD devices or Section 7.7 if using IDP or SK devices.
	Make sure correct polarity has been observed for SLC device wiring. See Section 7.8 if using SD devices or Section 7.7 for IDP or SK devices.
SLC devices are not being recognized (trouble message "Missing" displays on the annunciator).	<p>Check that SLC loop impedance is within the required range. To measure impedance, use the following procedure:</p> <ol style="list-style-type: none"> 1. Disconnect both wires from the terminal block at the panel (SLC devices can remain connected). 2. Measure the impedance from positive to negative and from negative to positive. Both measurements should be greater than 500 K ohms. If the installation uses T-taps, test each T-tap individually. 3. Temporarily connect the positive wire to the negative wire of the SLC loop at the point farthest from the panel (SLC devices can remain connected). 4. Measure the impedance from positive to negative and from negative to positive wires that were disconnected from the panel in step 1. Both measurements must be less than 50 ohms.
The panel indicates a ground fault trouble condition (trouble message "GROUND FAULT" displays).	An earth ground fault occurs when the panel senses an unexpected flow of current from one or more of its terminals to the earth connection (Terminal 2). Isolate the wiring that is causing the fault by removing wiring connections one at a time until the earth fault is no longer present. Pause at least five seconds after removing a wire before removing the next one.
5815XL module that has been physically connected to the panel but is not being recognized.	<p>Check the status of the 5815XL green LED. If it flashes in the pattern .5 sec. on / .5 sec. off, it is likely that the 5815XL has not been added to the system through programming. JumpStart will add any 5815XLs connected to the panel. 5815XLs can be added manually (see Section 9.2.2).</p> <p>Check that the correct ID for the 5815XL module has been set through the DIP switches. Assign ID#1 to the first 5815XL and ID#2 to the second 5815XL. See Section 4.13.1 for complete details.</p> <p>If the wiring between the 5815XL and the panel is correct, measure the voltage from 5815XL Terminal (+) to Terminal (-). Voltage should be in the range 27.2-27.4V when AC power is present.</p> <p>If the green LED is not flashing, the likely cause is incorrect wiring from between the 5815XL and the panel. See Section 4.8.1 for wiring details.</p> <p>*5815XL will only support SD devices</p>

Problem	Possible Cause / Suggested Actions
6815 module that has been physically connected to the panel but is not being recognized.	<p>Check the status of the 6815 green LED. If it flashes in the pattern .5 sec. on / .5 sec. off, it is likely that the 6815 has not been added to the system through programming. JumpStart will add any 6815s connected to the panel. 6815s can be added manually (see Section 9.2.2).</p> <p>Check that the correct ID for the 6815 module has been set through the DIP switches. Assign ID#1 to the first 6815 and ID#2 to the second 6815. See Section 4.13.1 for complete details.</p> <p>If the wiring between the 6815 and the panel is correct, measure the voltage from 6815 Terminal (+) to Terminal (-). Voltage should be in the range 27.2-27.4V when AC power is present.</p> <p>If the green LED is not flashing, the likely cause is incorrect wiring from between the 6815 and the panel. See Section 4.8.1 for wiring details.</p>

13.2 Periodic Testing and Maintenance

To ensure proper and reliable operation, it is recommended that system inspection and testing be scheduled monthly or as required by national and/or local fire codes. Testing should be done by a qualified service representative if a malfunction is encountered.

■ Before testing:

1. Notify the fire department and/or central alarm receiving station.
2. Notify facility personnel of a test so that alarm sounding devices are ignored during the test period.
3. When necessary, activation of Notification Appliances can be prevented by the DISABLE function.

■ Testing:

1. Activate a input via an alarm initiating device and check that the correct outputs activate (Notification Appliances sound/flash, relays activate, alarm indicator lights). Reset system. Repeat for each alarm initiating device.
2. Momentarily open the following circuits one at a time and check for a trouble sign:
 - Notification Appliance Circuits
 - Initiating devices
3. If new batteries were installed, wait 48 hours before completing this step. Remove AC power, activate initiating device and check that:
 - The alarm indicator lights
 - All active Notification Appliances sound

Measure battery voltage while the Notification Appliances are sounding. Replace any battery with terminal voltage less than 85% of rating. Reapply AC power and reset the system.

13.3 Event History

The event history can be useful for tracking or recalling a trouble condition.

To view event history:

1. Press 3 to select Event History.
2. Press the up or down arrow key to view events in the history buffer.

13.4 Built-in Troubleshooting and Testing Tools

The fire control panel has several built-in testing and troubleshooting tools that can be utilized to save time while testing and troubleshooting points and SLC devices.

13.4.1 SLC Device Locator

SLC device locator can be used to locate a device on a SLC loop.

Follow these steps to locate a particular SLC device:

1. Select 2 for Point Functions from the Main Menu.
2. Select 4 for SLC Single Device Locator.

A message similar to the one shown in Figure 13.1 will display.

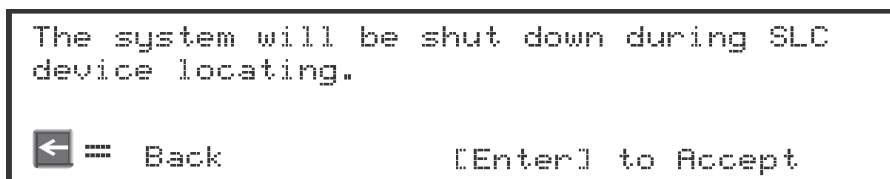

Figure 13.1 Shut Down Warning

3. Press ENTER to accept, or left arrow to Exit.

If left arrow is chosen you will exit back to the Point Function menu.

If ENTER is chosen the system will cease normal operation leaving the premise unprotected.

4. Select the SLC loop.
5. Enter the SLC address of the device you wish to locate.
The LED on the selected device will start flashing.
6. Press left arrow key to exit the SLC Device Locator.



NOTE: Once you exit, the system will resume normal operation.

13.4.2 SLC Multiple Device Locator

This feature is the same as SLC Single Device Locator, except you can locate up to 8 devices on a single search.

Follow these instructions to locate multiple SLC devices:

1. Select 2 for Point Functions from the Main Menu.
2. Select 5 for SLC Multiple Device Locator.

A message similar to the one shown in Figure 13.2 will display.

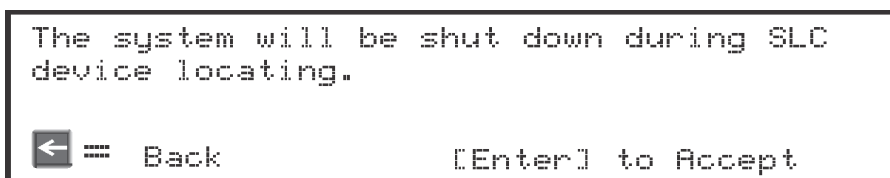

Figure 13.2 Shut Down Warning

3. Press ENTER to accept, or left arrow to Exit.
If left arrow is chosen you will exit back to the Point Function menu.
If ENTER is chosen the system will cease normal operation leaving the premise unprotected.
4. Select the SLC loop.
5. Enter up to 8 SLC addresses for the devices you wish to locate.
The LEDs on the selected devices will start flashing.
6. Press the left arrow key to exit SLC Multiple Device Locator.



NOTE: Once you exit, the system will resume normal operation.

13.4.3 I/O Point Control

This feature allows you to toggle any output on or off and trip any input device. This can be useful to test a point's output mapping. I/O Point Control shall only be allowed to be accessed if enabled by the user profile.

Follow these steps to control an I/O point:

1. Select 2 (Point Functions) from the Main Menu.
2. Select 6 (I/O Point Control).
3. Select the module the point is on.
4. Make any selections specific to the module selected in the previous step.
5. Use the up or down arrow key to select the point you wish to test.
6. Press ENTER to toggle (Active/Inactive) Output.
7. Press the left arrow key to exit.

13.4.4 Earth Fault Resistance

Table 13.1 lists the earth fault resistance detection for each applicable terminal on the FACP.

Function	Terminal Label		Low Biased		High Biased	
	(Values in Ohms)		High Trip	High Restore	Low Trip	Low Restore
Flexput™ Notification Circuits	X	I/O 8	-	-	0	0
	O		0	0	-	-
	X	I/O 7	-	-	0	0
	O		0	0	-	-
	X	I/O 6	-	-	0	0
	O		0	0	-	-
	X	I/O 5	-	-	0	0
	O		0	0	-	-
	X	I/O 4	-	-	0	0
	O		0	0	-	-
	X	I/O 3	-	-	0	0
	O		0	0	-	-
	X	I/O 2	-	-	0	0
	O		0	0	-	-
	X	I/O 1	-	-	0	0
	O		0	0	-	-
SBUS Communication	B	SBUS1 OUT	-	-	0	0
	A		-	-	0	0
SBUS Power	+		0	0	-	-
	-		-	-	0	0
SBUS Communication	B	SBUS1 IN	-	-	0	0
	A		-	-	0	0
SBUS Power	+		0	0	-	-
	-		-	-	0	0
SBUS Communication	B	SBUS2 OUT	-	-	0	0
	A		-	-	0	0
SBUS Power	+		0	0	-	-
	-		-	-	0	0
SBUS Communication	B	SBUS 2 IN	-	-	0	0
	A		-	-	0	0
SBUS Power	+		0	0	-	-
	-		-	-	0	0
SLC Terminals	-	SLC OUT	-	-	0	0
	+		0	0	-	-
	-	SLC IN	-	-	0	0
	+		0	0	-	-

Any wire to wire fault impedance is 0 ohms

Table 13.1 Earth Fault Resistance Values by Terminal

Section 14: Installation Records

This section of the manual is for you to use if you wish to track how points, zones, and groups have been programmed.

14.1 Detector and Module Point Record

If installing IDP or SK SLC devices, use Table 14.1 to record detector points (up to 159 per SLC loop) installed on the on-board SLC loop and make a copy of Table 14.2 to record installed modules (up to 159 per SLC loop).

Module	Addr	Zone / Group	Description	Module	Addr	Zone/ Group	Description
On-board	1			On-board	31		
On-board	2			On-board	32		
On-board	3			On-board	33		
On-board	4			On-board	34		
On-board	5			On-board	35		
On-board	6			On-board	36		
On-board	7			On-board	37		
On-board	8			On-board	38		
On-board	9			On-board	39		
On-board	10			On-board	40		
On-board	11			On-board	41		
On-board	12			On-board	42		
On-board	13			On-board	43		
On-board	14			On-board	44		
On-board	15			On-board	45		
On-board	16			On-board	46		
On-board	17			On-board	47		
On-board	18			On-board	48		
On-board	19			On-board	49		
On-board	20			On-board	50		
On-board	21			On-board	51		
On-board	22			On-board	52		
On-board	23			On-board	53		
On-board	24			On-board	54		
On-board	25			On-board	55		
On-board	26			On-board	56		
On-board	27			On-board	57		
On-board	28			On-board	58		
On-board	29			On-board	59		
On-board	30			On-board	60		
On-board	60			On-board	104		
On-board	61			On-board	105		
On-board	62			On-board	106		
On-board	63			On-board	107		
On-board	64			On-board	108		
On-board	65			On-board	109		
On-board	66			On-board	110		
On-board	67			On-board	111		
On-board	68			On-board	112		
On-board	69			On-board	113		
On-board	70			On-board	114		
On-board	71			On-board	115		
On-board	72			On-board	116		
On-board	73			On-board	117		
On-board	74			On-board	118		
On-board	75			On-board	119		

Table 14.1 Installation Record of Onboard Devices

14.2 Conventional Output Point Record

This chart can be used to keep track of how conventional output points (circuits) have been configured.

Point/Circuit	Group	Description
1		
2		
3		
4		
5		
6		
7		
8		

Appendix A: Compatible Devices

A.1 Notification Appliances

For proper operation, you must use polarized devices with a 4.7k ohm EOL resistor on each loop. All supervised notification appliances used with the control panel must be polarized.



NOTE: Not all devices can use the Sync feature, be sure to check table below to ensure the device you have chosen will work with this feature. This control is UL listed for panel wide Synchronization.

Table below lists notification appliances compatible with the fire alarm control panel. Appliances which can be synchronized indicate the type of SYNC available in the columns marked Audio and Visual.

Manufacturer	Model	Audio	Visual	Type
AMSECO	SH24W-153075	x	x	Horn/Strobe
	SAD24-153075		x	Strobe
	SAD24-75110		x	Strobe
	SL24W-75110		x	Strobe
	SL24C-3075110		x	Strobe
	SLB24-75		x	Strobe
	RSD24-153075		x	Strobe
	RSD24-75110		x	Strobe
	SH24W-75110	x	x	Horn/Strobe
	SH24W-3075110	x	x	Horn/Strobe
	SHB24-75	x	x	Horn/Strobe
	SCM24W-153075	x		Chimes/Strobe
	SCM24W-75110	x		Chimes/Strobe
	SCM24C-3075110	x		Chimes/Strobe
	SCM24C-177	x		Chimes/Strobe
	H24W	x		Horn
	H24R	x		Horn
FCI	S2415-FC		x	Strobe
	S241575-FC		x	Strobe
	S2430-FC		x	Strobe
	130-3117C	x		Mini Horn
	130-3147C	x		Mini Horn
	BLV-6	x		Vibrating Bell
	BLV-10	x		Vibrating Bell
	BLVCH	x		Vibrating Chime
	H12/24-FC	x		Horn
	H12/24W-FC	x		Horn
	H12/24K-FC	x		Horn
	HC12/24-FC	x		Horn

Table A.1 Compatible Notification Appliances

Manufacturer	Model	Audio	Visual	Type	
FCI (cont.)	HC12/24W-FC	X		Horn	
	HC12/24K-FC	X		Horn	
	P2415-FC	X	X	Horn/Strobe	
	P2415W-FC	X	X	Horn/Strobe	
	P2415K-FC	X	X	Horn/Strobe	
	P241575-FC	X	X	Horn/Strobe	
	P241575W-FC	X	X	Horn/Strobe	
	P241575F-FC	X	X	Horn/Strobe	
	P241575K-FC	X	X	Horn/Strobe	
	P2430-FC	X	X	Horn/Strobe	
	P2430W-FC	X	X	Horn/Strobe	
	P2430K-FC	X	X	Horn/Strobe	
	P2475-FC	X	X	Horn/Strobe	
	P2475W-FC	X	X	Horn/Strobe	
	P2475K-FC	X	X	Horn/Strobe	
	P24110-FC	X	X	Horn/Strobe	
	P24110W-FC	X	X	Horn/Strobe	
	P24110K-FC	X	X	Horn/Strobe	
	S2430W-FC			X	Strobe
	S2430K-FC			X	Strobe
	S2475-FC			X	Strobe
	S2475W-FC			X	Strobe
	S2475K-FC			X	Strobe
	S24110-FC			X	Strobe
S24110W-FC			X	Strobe	
S24110K-FC			X	Strobe	
Federal Signal	450	X		Horn	
	VALS	X	X	Horn/Strobe	

Table A.1 Compatible Notification Appliances

Manufacturer	Model	Audio	Visual	Type
Gentex	GEC-24-15	X	X	Horn/Strobe
	GEC-24-30	X	X	Horn/Strobe
	GEC-24-60	X	X	Horn/Strobe
	GEC-24-75	X	X	Horn/Strobe
	GEC-24-177	X	X	Horn/Strobe
	GEC-24-110	X	X	Horn/Strobe
	GEC-24-15/75	X	X	Horn/Strobe
	GX91	X		MiniHorn Steady Tone
	GX93	X		MiniHorn Temporal Tone
	HG124	X		Horn
	HS24-15	X	X	Horn/Strobe
	HS24-30	X	X	Horn/Strobe
	HS24-60	X	X	Horn/Strobe
	HS24-75	X	X	Horn/Strobe
	HS24-110	X	X	Horn/Strobe
	HS24-1575	X	X	Horn/Strobe
	GCC24	X	X	Multi Candella Horn/Strobe Ceiling Mount
	GCCR24		X	Multi Candella Horn/Strobe Ceiling Mount
	GCS24		X	Multi Candella Strobe Ceiling Mount
	GCSR24		X	Multi Candella Strobe Ceiling Mount
	GECR-24	X	X	Multi Candella Horn/Strobe
	GES24-15		X	Strobe
	GES24-30		X	Strobe
	GES24-60		X	Strobe
	GES24-75		X	Strobe
	GES24-110		X	Strobe
	GES24-15/75		X	Strobe
	GES24-177		X	Strobe
	GES3-24		X	Multi Candella Strobe
	GESR-24		X	Multi Candella Strobe
	GEH-24	X		Horn
	ST24-30		X	Strobe
	ST24-60		X	Strobe
ST24-75		X	Strobe	
ST24-110		X	Strobe	
Gentex (cont.)	ST24-1575		X	Strobe
	WGEC24-75W	X	X	Weatherproof Horn/Strobe
	WGES24-75W		X	Weatherproof Strobe
	WGMS-24-X	X	X	Horn/Strobe

Table A.1 Compatible Notification Appliances

Manufacturer	Model	Audio	Visual	Type
System Sensor	CHR	x		Chime
	CHW	x		Chime
	CHSR	x	x	2-Wire Chime/Strobe
	CHSW	x	x	2-Wire Chime/Strobe
	HR	x	x	Horn
	HW		x	Horn
	HRK		x	Horn
	HWL		x	Horn WHT Wall 4x4
	HRL		x	Horn Red Wall 4x4
	HGRL		x	Horn Red Wall 2x4
	HGWL		x	Horn WHT Wall 2x4
	CHWL	x		Chime WHT Wall 4x4
	CHRL	x		Chime Red Wall 4x4
	CHSRL	x	x	Chime/Strobe Red Wall 4x4
	CHSWL	x	x	Chime/Strobe WHT Wall 4x4
	CHSCRL	x	x	Chime/Strobe Red Ceil 4x4
	CHSCWL	x	x	Chime/Strobe WHT Ceil 4x4
	P2R	x	x	2-Wire Horn/Strobe
	P2R-P	x	x	2-Wire Horn/Strobe
	PC2R	x	x	2-Wire Horn/Strobe
	PC2R-P	x	x	2-Wire Horn/Strobe
	P2RH	x	x	2-Wire Horn/Strobe High Candela
	P2RH-P	x	x	2-Wire Horn/Strobe High Candela
	PC2RH	x	x	2-Wire Horn/Strobe High Candela
	PC2RH-P	x	x	2-Wire Horn/Strobe High Candela
	P2W	x	x	2-Wire Horn/Strobe
	P2W-P	x	x	2-Wire Horn/Strobe
	PC2W	x	x	2-Wire Horn/Strobe
	PC2W-P	x	x	2-Wire Horn/Strobe
	P2WH	x	x	2-Wire Horn/Strobe High Candela
	P2WH-P	x	x	2-Wire Horn/Strobe High Candela
	PC2WH	x	x	2-Wire Horn/Strobe High Candela
	PC2WH-P	x	x	2-Wire Horn/Strobe High Candela
	P2RK	x	x	2-Wire Horn/Strobe
	PC2RK	x	x	2-Wire Horn/Strobe
	P2RHK	x	x	2-Wire Horn/Strobe High Candela
PC2RHK	x	x	2-Wire Horn/Strobe High Candela	
P4R	x	x	4-Wire Horn/Strobe	
PC4R	x	x	4-Wire Horn/Strobe	
P4RH	x	x	4-Wire Horn/Strobe High Candela	

Table A.1 Compatible Notification Appliances

Manufacturer	Model	Audio	Visual	Type
System Sensor (cont.)	P4W	X	X	4-Wire Horn/Strobe
	PC4W	X	X	4-Wire Horn/Strobe
	P4WH	X	X	4-Wire Horn/Strobe High Candela
	PC4WH	X	X	4-Wire Horn/Strobe High Candela
	P4RK	X	X	4-Wire Horn/Strobe
	PC4RK	X	X	4-Wire Horn/Strobe
	P4RHK	X	X	4-Wire Horn/Strobe High Candela
	PC4RHK	X	X	4-Wire Horn/Strobe High Candela
	PC4RH	X	X	4-Wire Horn/Strobe High Candela
	P2RL, P2RL-P, P2RL-SP*	X	X	Horn/Strobe 2W Red Wall 4x4
	P2WL, P2WL-P, P2WL-SP*	X	X	Horn/Strobe 2W WHT Wall 4x4
	PC2RL	X	X	Horn/Strobe 2W Red Ceil 4x4
	PC2WL	X	X	Horn/Strobe 2W WHT Ceil 4x4
	P2GRL	X	X	Horn/Strobe 2W Red Wall 2x4
	P2GWL	X	X	Horn/Strobe 2W WHT Wall 2x4
	P4RL	X	X	Horn/Strobe 4W Red Wall 4X4
	P4WL	X	X	Horn/Strobe 4W WHT Wall 4X4
	PC4RL	X	X	Horn/Strobe 4W Red Ceil 4X4
	PC4WL	X	X	Horn/Strobe 4W WHT Ceil 4X4
	SR		X	Strobe
	SR-P		X	Strobe
	SCR		X	Strobe
	SCR-P		X	Strobe
	SRH		X	Strobe High Candela
	SRH-P		X	Strobe High Candela
	SCRH		X	Strobe High Candela
	SCRH-P		X	Strobe High Candela
	SW		X	Strobe
	SW-P		X	Strobe
	SCW		X	Strobe
	SCW-P		X	Strobe
	SWH		X	Strobe High Candela
	SWH-P		X	Strobe High Candela
	SCWH		X	Strobe High Candela
	SCWH-P		X	Strobe High Candela
	SRK		X	Strobe
	SCRK		X	Strobe
	SRHK		X	Strobe High Candela
	SCRHK		X	Strobe High Candela
	SRL, SRL-P, SRL-SP*		X	Strobe Red Wall 4x4
	SWL, SWL-P, SWL-ALERT SWL-CLR-ALERT*		X	Strobe White Wall 4x4
	SCRL		X	Strobe Red Ceil 4x4
	SCWL		X	Strobe White Ceil 4x4
	SCWL-CLR-ALERT		X	Strobe WHT Ceil CLR Lens 4x4
	SGRL		X	Strobe Red Wall 2x4
	SGWL		X	Strobe White Wall 2x4
	P2RH-LF	X	X	2-Wire Low Frequency Sounder Strobe
	P2WH-LF	X	X	2-Wire Low Frequency Sounder Strobe
	HR-LF	X		Low Frequency Sounder

Table A.1 Compatible Notification Appliances

Manufacturer	Model	Audio	Visual	Type
System Sensor (cont.)	HW-LF	X		Low Frequency Sounder
	SEP-SPSWL**			Universal Expander Plate, Amber Lens, White, ALERT
	SEP-SPSWL-P**			Universal Expander Plate, White, Plain
	SEP-BBSWL**			Universal Expander Plate Back Box Skirt, White
* P=Plain, ALERT=Pad Printing ALERT, SP=Fuego				
** Expander plates are for vertical wall mounting only. Indoor applications. Must be mounted in the correct orientation. "UP" is indicated on the part to designate the top of the plate				
Wheelock	AH-12	X		Horn
	AH-24	X		Horn
	AH-12WP	X		Horn Weatherproof
	AH-24WP	X		Horn Weatherproof
	AMT-241575W	X	X	Multi-Tone Horn Strobe
	AMT-24MCW		X	Multi-Tone Horn Strobe
	AMT-241575W-NYC	X	X	Multi-Tone Horn Strobe
	AMT-12/24	X		Multi-tone Horn
	AMT-12/24 NYC	X		Multi-tone Horn
	AS-121575W		X	Horn/Strobe
	NH-12/24	X	X	Horn
	AS-241575W	X	X	Horn/Strobe
	AS-24MCC	X	X	Horn/Strobe
	AS-24MCCH	X	X	Horn/Strobe
	AS-24MCW	X	X	Horn/Strobe
	AS-24MCWH	X	X	Horn/Strobe
	ASWP-2475W	X	X	Horn/Strobe Weatherproof
	ASWP-2475C	X	X	Horn/Strobe Weatherproof
	ASWP-24MCWH	X	X	Horn/Strobe
	ASWP-24MCCH	X	X	Horn/Strobe
	CH-70	X		Chime
	CH-90	X		Chime
	CH70-241575W		X	Chime/Strobe
	CH70-24MCW		X	Chime/Strobe
	CH70-24MCWH		X	Chime/Strobe
	CH90-24MCC		X	Chime/Strobe
CH90-24MCCH		X	Chime/Strobe	

Table A.1 Compatible Notification Appliances

Manufacturer	Model	Audio	Visual	Type
Wheelock (cont.)	HS-24	X		Horn
	HS4-241575W	X	X	Horn/Strobe
	HS4-24MCW	X	X	Horn/Strobe
	HS4-24MCWH	X	X	Horn/Strobe
	HS4-24MCC	X	X	Horn/Strobe
	MIZ-24S	X	X	Mini Horn Strobe
	MT-121575W		X	MultitoneHorn Strobe
	MT-241575W	X	X	Multitone Horn Strobe
	MT-24MCW		X	Multitone Horn Strobe
	MTWP-2475W		X	Multitone Horn Strobe
	MTWP-2475C		X	Multitone Horn Strobe
	MTG-121575W	X	X	Multitone Horn Strobe
	MTR-121575W	X	X	Multitone Horn Strobe
	MTWPA-2475W	X	X	Multitone Horn Strobe
	MTWPB-2475W	X	X	Multitone Horn Strobe
	MTWPG-2475W	X	X	Multitone Horn Strobe
	MTWPR-2475W	X	X	Multitone Horn Strobe
	MTWPA-24MCCH	X	X	Multitone Horn Strobe
	ZNH	X		Horn
	NS-121575W	X	X	Horn/Strobe
	NS-241575W	X	X	Horn/Strobe
	NS-24MCW	X	X	Horn/Strobe
	NS-24MCC	X	X	Horn/Strobe
	NS-24MCCH	X	X	Horn/Strobe
	ZNS-MCW	X	X	Horn/Strobe
	ZNS-MCWH	X	X	Horn/Strobe
	ZNS-24MCC	X	X	Horn/Strobe
	ZNS-24MCCH	X	X	Horn/Strobe
	RSS-121575W		X	Strobe
	RSS-241575W		X	Strobe
	RSS-24MCC		X	Strobe
	RSS-24MCCR		X	Strobe
	RSS-24MCCH		X	Strobe
	RSS-24MCCHR		X	Strobe
	RSS-24MCW		X	Strobe
	RSS-24MCWH		X	Strobe
	RSSP-121575W		X	Strobe
	RSSP-241575W		X	Strobe
	RSSR-2415W		X	Strobe
	RSSR-2415C		X	Strobe

Table A.1 Compatible Notification Appliances

Manufacturer	Model	Audio	Visual	Type
Wheelock (cont.)	RSSR-2475W		x	Strobe
	RSSR-2475C		x	Strobe
	RSSR-24110C		x	Strobe
	RSSA-24110W		x	Strobe
	RSSB-24110W		x	Strobe
	RSSG-24110W		x	Strobe
	RSSR-24110W		x	Strobe
	RSSA-24MCC		x	Multi-Cd Strobe
	RSSB-24MCC		x	Multi-Cd Strobe
	RSSG-24MCC		x	Multi-Cd Strobe
	RSSR-24MCC		x	Multi-Cd Strobe
	RSSWPA-2475W		x	Strobe Weatherproof
	RSSWPA-24MCCH		x	Strobe Weatherproof
	RSSWPG-24MCCH		x	Strobe Weatherproof
	RSSWPR-24MCCH		x	Strobe Weatherproof
	RSSWP-2475W		x	Strobe Weatherproof
	RSSWP-2475C		x	Strobe Weatherproof
	RSSWP-24MCWH		x	Strobe Weatherproof
	ZRS-MCWH		x	Strobe
	ZRS-24MCC		x	Strobe
	ZRS-24MCCH		x	Strobe
	MB-G6-24	x		Motor Bell
	MB-G10-24	x		Motor Bell
	MB-G6-12	x		Motor Bell
	MB-G10-12	x		Motor Bell
	MIZ-24-R	x		Mini-Horn
	MT-12/24-R	x	x	Multitone Horn
	MT4-12/2z	x	x	Multitone Horn
	ZRS-MCW		x	Strobe
	MTWPR-24MCCH	x	x	Multitone Horn Strobe
	NH-12/24R	x		Horn
	HSR		x	Horn/Strobe
	HSW		x	Horn/Strobe
	STR		x	Strobe
	STW		x	Strobe
	HNR		x	Horn
HNW		x	Horn	

Table A.1 Compatible Notification Appliances

A.2 Two Wire Detectors

Table A.2 lists two-wire smoke detectors that are compatible with the fire control panel. The table is organized by manufacturer. The columns show the number of detectors per loop that can be used..

	IFP-2100/ECS
Identifier	24H
Operating voltage Range	17.1 - 27.3 VDC



NOTE: The maximum number of smoke detectors per zone is determined by both the current draw and the impedance of the smoke detector. If too many smoke detectors are used on any zone, false alarms could occur.

NOTE: Do not mix different models of detectors on any zone; false alarms could occur.

NOTE: Control unit Smoke Reset Time must be programmed for a number greater than or equal to the maximum reset time of the smoke detector

Manufacturer	Model Name or Number (Base model name or number in parenthesis.)	Compatibility ID		# per Loop
		Head	Base	
Apollo	55000-350 (45681-200)	55000-350	45681-200	15 / loop
	55000-250 (45681-200)	55000-250	45681-200	24 / loop
	55000-225	55000-225	45681-255, 256	15 / loop for Ion Detectors
	55000-226	55000-226	45681-200, 220, 232, 251, 252	
	55000-227	55000-227		15 / loop for Photo Electric Detectors
	55000-325	55000-325		
	55000-326	55000-326		
	55000-327	55000-327		
55000-328	55000-328			
Hochiki	SLR-24	HD-3	HSC-220R(HB-72) NS6-220 OR NS4-220 (HB-3)	15 / loop
	SLR-24H			
	SLR-24V			
	SLR-835	HD-3		14 / loop
	SLR-835H	HD-5		
System Sensor	1400	A	N/A	16 / loop
	1451 (B401B)	A	N/A	16 / loop
	2100	A	N/A	20 / loop
	2100T	A	N/A	20 / loop
	2151 (B401)	A	N/A	16 / loop
	2151T (B401)	A	N/A	16 / loop
	2400	A	N/A	16 / loop
	2400TH	A	N/A	16 / loop
	2451 (B401B)	A	N/A	16 / loop
	2451TH (B401B)	A	N/A	16 / loop
	2W-B	A	N/A	20 / loop
	2WT-B	A	N/A	20 / loop
	2WTA-B	A	N/A	20 / loop
	2WTR-B	A	N/A	20 / loop

Table A.2 Compatible Two-Wire Smoke Detectors

A.3 Four-Wire Smoke Detectors/Devices (UL Listed)

Smoke Detector/Base	Detector Type	Max Standby Current (mA)	Alarm Current (mA)
Fenwal CPD-7021 (w/70-201000-005 Base)	Ionization	0.10	*
Fenwal PSD-7125	Photoelectric	0.10	*
Fenwal PSD-7126 (w/70-201000-005 Base)	Photoelectric	0.10	*
Fire-Lite BLP-12-4W	Base	*	*
Gentex 824	Photoelectric	0.50	*
Gentex 824T	Photoelectric	0.50	*
Gentex 824CP	Photoelectric	0.50	*
Gentex 824CPT	Photoelectric	0.50	*
Hochiki HSC-4R	Base	*	*
Hochiki SPB-24	Projected Beam	0.25	*
System Sensor B112LP	Base	0.12	36
System Sensor B114LP	Base	*	*
System Sensor B404B	Base	*	*
System Sensor DH100ACDC	Photoelectric	0.15	0.70
System Sensor DH100ACDCLP	Photoelectric	0.15	0.70
System Sensor DH100ACDCLWP	Photoelectric	0.15	0.70
System Sensor DH400ACDCI	Ionization Duct	25	95
System Sensor DH400ACDCP	Photoelectric Duct	25	95
System Sensor 1112/24/D	Ionization	0.05	50
System Sensor 1424	Ionization	0.10	41
System Sensor 1451 (w/B402B Base)	Ionization	0.10	39
System Sensor 2112/24ATR	Photoelectric	0.50	60/70
System Sensor 2112/24AITR	Photoelectric	0.50	60/70
System Sensor 2112/24/D	Photoelectric	0.05	50
System Sensor 2112/24R	Photoelectric	0.50	60/70
System Sensor 2112/24TR	Photoelectric	0.50	60/70
System Sensor 2112/24T/D	Photoelectric w/135° Thermal	0.05	50
System Sensor 2112/24TSRB	Photoelectric w/135° Thermal Supervisory Relay	15	45
System Sensor 2312/24TB	Photoelectric	0.12	50
System Sensor 2412 (12 volt)	Photoelectric	0.12	77
System Sensor 2412AT (12 volt)	Photoelectric	0.12	58
System Sensor 2412TH (12 volt)	Photoelectric	0.12	77
System Sensor 2424	Photoelectric	0.10	41
System Sensor 2424TH	Photoelectric	0.10	41
System Sensor 2451	Photoelectric	0.10	39
System Sensor 2451TH (with/B402B Base)	Photoelectric	0.10	39
System Sensor 2W-MOD	Loop Test/Maintenance Mod.	30	50
System Sensor 4W-B (12/24 Volt)	Photoelectric I ³	.05	23
System Sensor 4WT-B (12/24 Volt)	Photoelectric I ³ w/Therm	.05	23
System Sensor 4WTA-B (12/24 Volt)	I ³ Photo w/ Therm Sounder	.05	35
System Sensor 4WTR-B (12/24 Volt)	I ³ Photo w/ Therm/Relay	.05	35
System Sensor 4WTAR-B (12/24 Volt)	I ³ Photo w/ Therm/Sounder/Relay	.05	50
System Sensor 4WITAR-B (12/24 Volt)	I ³ Photo w/ Isolated Therm/Sounder/Relay	.05	50
System Sensor 2W-MOD2	I ³ Loop Test/Maintenance Mod.	.05	*
System Sensor RRS-MOD	I ³ Reversing Relay/Sync Module	.05	*
System Sensor 6424	Projected Beam	10	28.4
System Sensor Beam 1224(S)	Projected Beam	17	38.5

* Contact manufacturer for current draws

Table A.3 Compatible Four-Wire Smoke Detectors

A.4 Door Holders (UL Listed)

The below lists door holders that are compatible with the fire control panel.

Manufacturer	Model	Type	Current (mA)
Edwards	DH150A	Floor Mount	96
Edwards	DH154A	Flush Mount	96
Edwards	DH158A	Surface Mount	96
Rixon Firemark	FM-980	Floor Mount, single	68
Rixon Firemark	FM-996	Surface Wiring	68
Rixon Firemark	FM-998	Concealed Wiring	68

Table A.4

A.5 Relays (UL Listed)

The below table lists relays compatible with the fire control panel.

Manufacturer	Model	Current (mA)
Air Products & Controls, LTD	MR-101/C	15
	MR-201/C	35
	PAM-1	15
	PAM-2	15
	PAM-SD	15
System Sensor	A77-716B	20
	PR-1	15
	PR-2	30
	PR-3	30
	EOLR-1	30
	R-10T	23
	R-14T	23
	R-20T	40
	R-24T	40
	R-10E	23
	R-14E	23
R-20E	40	
R-24E	40	

Table A.5

A.6 Compatible 520Hz Signaling Speakers

Model Number	Description
SPR	Wall High-Fidelity Speaker, Red
SPW	Wall High-Fidelity Speaker, White
SPCR	Ceiling High-Fidelity Speaker, Red
SPCW	Ceiling High-Fidelity Speaker, White
SPSR	Wall High-Fidelity Speaker Strobe, Red
SPSRH	Wall High-Fidelity Speaker Strobe, High Candela, Red
SPSW	Wall High-Fidelity Speaker Strobe, White
SPSCR	Ceiling High-Fidelity Speaker Strobe, Red
SPSCW	Ceiling High-Fidelity Speaker Strobe, White
SPSCWH	Ceiling High-Fidelity Speaker Strobe, High Candela, White
SPSCRH	Ceiling High-Fidelity Speaker Strobe, High Candela, Red
SPSCW-CLR-ALERT	Ceiling High-Fidelity Speaker Strobe, Clear Lens, ALERT, White
SPSCW-P	Ceiling High-Fidelity Speaker Strobe, Plain, White
SPSCWH-P	Ceiling High-Fidelity Speaker Strobe, High Candela, Plain, White
SPSR-P	Wall High-Fidelity Speaker Strobe, Plain, Red
SPSRH-P	Wall High-Fidelity Speaker Strobe, High Candela, Plain, Red
SPSCWH-P	Ceiling High-Fidelity Speaker Strobe, High Candela, Plain, White
SPSW-ALERT	Wall High-Fidelity Speaker Strobe, Amber Lens, ALERT, White
SPSW-CLR-ALERT	Wall High-Fidelity Speaker Strobe, Clear Lens, ALERT, White
SPSW-P	Wall High-Fidelity Speaker Strobe, Plain, Red
SPSWH	Wall High-Fidelity Speaker Strobe, High Candela, White
SPSWH-P	Wall High-Fidelity Speaker Strobe, High Candela, Plain, Red
SPRL	Wall High-Fidelity Speaker, Red
SPWL	Wall High-Fidelity Speaker, White
SPCRL	Ceiling High-Fidelity Speaker, Red
SPCWL	Ceiling High-Fidelity Speaker, White
SPSCRL	Ceiling High-Fidelity Speaker Strobe, Red
SPSCWL	Ceiling High-Fidelity Speaker Strobe, White
SPSRL	Wall High-Fidelity Speaker Strobe, Red
SPSRL-SP	Wall High-Fidelity Speaker Strobe-FUEGO
SPSWL	Wall High-Fidelity Speaker Strobe, White
SPSCWL-P	Ceiling High-Fidelity Speaker Strobe, Standard, White, Plain
SPSRL-P	Ceiling High-Fidelity Speaker Strobe, Standard, Red, Plain
SPSWL-P	Wall High-Fidelity Speaker Strobe, Standard, White, Plain
SPSCWL-CLR-ALERT	Ceiling High-Fidelity Speaker Strobe, Clear Lens, Standard, White, ALERT
SPSWL-ALERT	Wall High-Fidelity Speaker Strobe, Amber Lens, ALERT, White
SPSWL-CLR-ALERT	Wall High-Fidelity Speaker Strobe, Clear Lens, Standard, ALERT, White
*F=FIRE, P=PLAIN, AL=ALERT, AG=AGENT, EV=EVAC, SP=FUEGO, PG=FOGO	

Table A.6

A.7 Compatible 520Hz Low Frequency Bases

Model Number	Description
B200S-LF-WH / IV	Low Frequency Intelligent Sounder Base. White or Ivory
B200SR-LF-WH / IV	Low Frequency Intelligent Sounder Base. White or Ivory
IV = Ivory color	

Table A.7

Appendix B: Editing Text Using the Built-In Programmer

This section contains tables of programmable characters that may be used for device, module, site, template, group, and zone names or phone numbers. T9 style editing is used.

B.1 Characters Used for Editing Text

Table B.1 lists the available characters and their associated numeric designator. When programming:

1. Use the Up or Down arrow key to scroll to the mode wanted.
2. Press the number shown in Table B.1 until the character wanted is shown.
3. Arrow left and right for position, and press enter to accept.

Lower Case Letters			
abc1	def2	ghi3	jkl4
mno5	pqr6	stu7	vwx8
yz9	Spc0		
Upper Case Letters			
ABC1	DEF2	GHI3	JKL4
MNO5	PQR6	STU7	VWX8
YZ9	Spc0		
Numbers and Special Characters			
1 []1	2 ()2	3 . ,3	4 : ;4
5 ' "5	6 ? !6	7 ' /7	8 - +8
9 = -9	0 0	* & @ *	# \$ #

Table B.1 : Character Table

B.2 Example Name Edit

1. Press the up or down arrow to select upper case letters mode, Press 2 until "F" appears.
2. Press the up or down arrow to change mode to lower case letters, Press 3 until "i" appears.
3. Press 6 until "r" appears.
4. Press 2 until "e" appears.
5. Press 0 to space, then continue to next word using the same process.
6. Press ENTER to accept.



NOTE: After three seconds of no change, letter will automatically be accepted. Also pressing next number will automatically accept previous choice

```

<Module Name>      Enter: Accept
Fire_Door_____
 1[abc] 2[def] 3[ghi] 4[jkl] 5[mno]
 6[pqr] 7[stu] 8[vwx] 9[yz ] 0[Spc]
  
```

Figure B.1 Edit Name Example

Appendix C: Cadence Patterns

The cadence patterns shown in Appendix C are available for use with the control panel.





#	Name	Pattern Description																										
00	Constant	Continuous sound Patterns repeat until condition is cleared. <small>Note: This is the only pattern that can be used for relay circuits. The system will override any other choice.</small>																										
01	March Code	 .5 sec on .5 sec off																										
02	ANSI 3.41																											
03	Single Stroke																											
04	California																											
05 ⋮ 16	Zone Coded	<table border="1" style="width: 100%; border-collapse: collapse;"> <thead> <tr> <th>Pattern#</th> <th>Zone</th> </tr> </thead> <tbody> <tr><td>5</td><td>Zone 1</td></tr> <tr><td>6</td><td>Zone 2</td></tr> <tr><td>7</td><td>Zone 3</td></tr> <tr><td>8</td><td>Zone 4</td></tr> <tr><td>9</td><td>Zone 5</td></tr> <tr><td>10</td><td>Zone 6</td></tr> <tr><td>11</td><td>Zone 7</td></tr> <tr><td>12</td><td>Zone 8</td></tr> <tr><td>13</td><td>Custom 1</td></tr> <tr><td>14</td><td>Custom 2</td></tr> <tr><td>15</td><td>Custom 3</td></tr> <tr><td>16</td><td>Custom 4</td></tr> </tbody> </table>  EXAMPLE: Pattern 06, Zone 2 coded 	Pattern#	Zone	5	Zone 1	6	Zone 2	7	Zone 3	8	Zone 4	9	Zone 5	10	Zone 6	11	Zone 7	12	Zone 8	13	Custom 1	14	Custom 2	15	Custom 3	16	Custom 4
Pattern#	Zone																											
5	Zone 1																											
6	Zone 2																											
7	Zone 3																											
8	Zone 4																											
9	Zone 5																											
10	Zone 6																											
11	Zone 7																											
12	Zone 8																											
13	Custom 1																											
14	Custom 2																											
15	Custom 3																											
16	Custom 4																											
17 ⋮ 21	<table border="1" style="width: 100%; border-collapse: collapse;"> <thead> <tr> <th>Pattern #</th> <th>Sync Type</th> </tr> </thead> <tbody> <tr><td>17</td><td>Faraday- not allowed</td></tr> <tr><td>18</td><td>Gentex</td></tr> <tr><td>19</td><td>System Sensor</td></tr> <tr><td>20</td><td>Wheelock</td></tr> <tr><td>21</td><td>Amesco</td></tr> </tbody> </table>	Pattern #	Sync Type	17	Faraday- not allowed	18	Gentex	19	System Sensor	20	Wheelock	21	Amesco	These outputs provide synchronization for AMSECO, Gentex, System Sensor, or Wheelock synchronized appliances.														
Pattern #	Sync Type																											
17	Faraday- not allowed																											
18	Gentex																											
19	System Sensor																											
20	Wheelock																											
21	Amesco																											
22	Power Isolated	Disconnected, no voltage at terminals																										
23	Temporal 4																											

Figure C.1 Cadence Patterns Available with the Control Panel

Appendix D: Expanded Receiver/Panel Relationship

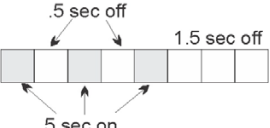
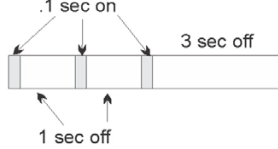
The available receiver number will correspond with what panel number you entered. Receiver numbers are populated based on panel number and audited to allow only the 4 appropriate receivers. See Section 6.2.6.

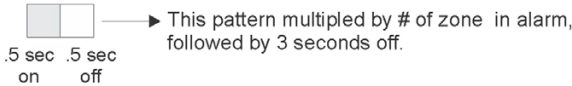
Panel	Available receiver numbers			
1	1	2	3	4
2	5	6	7	8
3	9	10	11	12
4	13	14	15	16
5	17	18	19	20
6	21	22	23	24
7	25	26	27	28
8	29	30	31	32
9	33	34	35	36
10	37	38	39	40
11	41	42	43	44
12	45	46	47	48
13	49	50	51	52
14	53	54	55	56
15	57	58	59	60
16	61	62	63	64
17	65	66	67	68
18	69	70	71	72
19	73	74	75	76
20	77	78	79	80
21	81	82	83	84
22	85	86	87	88
23	89	90	91	92
24	93	94	95	96
25	97	98	99	100
26	101	102	103	104
27	105	106	107	108
28	109	110	111	112
29	113	114	115	116
30	117	118	119	120
31	121	122	123	124
32	125	126	127	128

Table D.1 Receiver/panel relationship

Appendix E: Panel Security

E.1 Panel installation / maintenance security checklist

System Description: _____

System Location: _____

Installer: _____ Date: _____

Complete the following Cyber security tasks for each panel Install

- Install the panel in a secure location considering both software and hardware vulnerabilities.
- Change the default password to a unique password
- Securely configure networks and firewalls
- Assess security risks
- Develop a Disaster and Recovery Plan
- Develop a Backup and Recovery Strategy
- Install, configure and keep anti virus software updated on all computers which access the panel
- Keep operating system updated on all computers which access the panel
- Deliver all required system information upon delivery to the system owner
- Train end-users on security maintenance tasks upon system delivery
- For decommissioning, dispose of data securely.
- Ensure the Ethernet cable is removed from the FACP when not being utilized for configuration or for reporting purposes.

Security and Data Protection

Communication Security - Level 1

Stored Data Security - Level 0

Physical Security - Level 1

Access Control Security - Level 1

Manufacturer Warranties and Limitation of Liability

Manufacturer Warranties. Subject to the limitations set forth herein, Manufacturer warrants that the Products manufactured by it in its Northford, Connecticut facility and sold by it to its authorized Distributors shall be free, under normal use and service, from defects in material and workmanship for a period of thirty six months (36) months from the date of manufacture (effective Jan. 1, 2009). The Products manufactured and sold by Manufacturer are date stamped at the time of production. Manufacturer does not warrant Products that are not manufactured by it in its Northford, Connecticut facility but assigns to its Distributor, to the extent possible, any warranty offered by the manufacturer of such product. This warranty shall be void if a Product is altered, serviced or repaired by anyone other than Manufacturer or its authorized Distributors. This warranty shall also be void if there is a failure to maintain the Products and the systems in which they operate in proper working conditions.

MANUFACTURER MAKES NO FURTHER WARRANTIES, AND DISCLAIMS ANY AND ALL OTHER WARRANTIES, EITHER EXPRESSED OR IMPLIED, WITH RESPECT TO THE PRODUCTS, TRADEMARKS, PROGRAMS AND SERVICES RENDERED BY MANUFACTURER INCLUDING WITHOUT LIMITATION, INFRINGEMENT, TITLE, MERCHANTABILITY, OR FITNESS FOR ANY PARTICULAR PURPOSE. MANUFACTURER SHALL NOT BE LIABLE FOR ANY PERSONAL INJURY OR DEATH WHICH MAY ARISE IN THE COURSE OF, OR AS A RESULT OF, PERSONAL, COMMERCIAL OR INDUSTRIAL USES OF ITS PRODUCTS.

This document constitutes the only warranty made by Manufacturer with respect to its products and replaces all previous warranties and is the only warranty made by Manufacturer. No increase or alteration, written or verbal, of the obligation of this warranty is authorized. Manufacturer does not represent that its products will prevent any loss by fire or otherwise.

Warranty Claims. Manufacturer shall replace or repair, at Manufacturer's discretion, each part returned by its authorized Distributor and acknowledged by Manufacturer to be defective, provided that such part shall have been returned to Manufacturer with all charges prepaid and the authorized Distributor has completed Manufacturer's Return Material Authorization form. The replacement part shall come from Manufacturer's stock and may be new or refurbished. THE FOREGOING IS DISTRIBUTOR'S SOLE AND EXCLUSIVE REMEDY IN THE EVENT OF A WARRANTY CLAIM.

Warn-HL-08-2009.fm

Model IFP-2100 Basic Operating Instructions



These instructions must be framed and displayed next to the IFP-2100 panel in accordance with NFPA 72 fire code for Local Protected Fire Alarm Systems. Test the system in accordance to NFPA 72.

Operation	Task to Perform
Silence Alarms and Troubles	Press SILENCE then enter a code if prompted. Silence LED will light.
Reset Alarms	Press RESET then enter a code if prompted.
View Alarms, Supervisories, and Troubles	For each type of condition, press the up or down arrow associated with Alarm, Supervisory, or Trouble. <div style="border: 1px solid black; padding: 5px; margin: 10px auto; width: fit-content;"> <pre style="font-family: monospace; text-align: center;"> FIRE: ALARM SUPERVISORY TROUBLE CO: ALARM SUPERVISORY SYSTEM: TROUBLE </pre> </div>
View status of Point	<ol style="list-style-type: none"> 1. Enter the installer code. The panel will automatically go to the main menu. 2. Press 2 to select Point Functions. 3. Enter code if prompted, then press 2 to select Point Status. 4. Select the module the device is located on by using the up or down arrow. Then press ENTER. 5. Enter the point number.
Conduct a Fire Drill	<p>Hold the DRILL button and then enter a code if prompted. OR</p> <ol style="list-style-type: none"> 1. Enter the installer code. The panel will automatically go to the main menu. 2. Press 1 to select System Tests. 3. Enter code if prompted, then press 1 to select Fire Drill. 4. Press ENTER to start the fire drill., and Press ENTER to end the fire drill.
Check Detector Sensitivity	<ol style="list-style-type: none"> 1. Follow steps 1 through 5 for viewing a point's status. 2. Press the right arrow to view detector sensitivity.
Set Time and Date	<ol style="list-style-type: none"> 1. Enter the installer code. The panel will automatically go to the main menu. 2. Press 4 to select Set Time & Date. Enter a code if prompted. 3. Make changes to the fields on the screen as necessary. 4. Press ENTER if you wish to keep the changes. 5. Press ENTER to set the entered time and date.
Enable / Disable a Point	<ol style="list-style-type: none"> 1. Enter the installer code. The panel will automatically go to the main menu. 2. Press 2 to select Point Functions. 3. Press 1 to select Disable / Enable Point. 4. Press 7 to select Disable/Enable Point. 5. Select the module the point is located on by using the up or down arrow. Then press ENTER. 6. Enter the point number then press ENTER. 7. Press the right arrow to Disable/Enable Point.
View Event History	<ol style="list-style-type: none"> 1. Enter the installer code. The panel will automatically go to the main menu. 2. Press 3 to select Event History. 3. Enter code if prompted. 4. Press the up or down arrow to view events in the history buffer.
For Service call:	

Cut Along the Dotted Line

Cut Along the Dotted Line



Model IFP-2100ECS Basic Operating Instructions

These instructions must be framed and displayed next to the IFP-2100ECS panel in accordance with NFPA 72 fire code for Local Protected Fire Alarm Systems.

FS = Fire System ECS = Emergency Communication System

Operation	Task to Perform
Silence Alarms and Troubles	Press SILENCE then enter a code if prompted. Silence LED will light.
Reset Alarms	<ol style="list-style-type: none"> 1. Press RESET. 2. Press 1 to Reset Fire System. 3. Press 2 to Reset Emergency Communication. System. <p><i>Note: To reset ECS at an LOC, the user must gain ECS Control (See Figure 1).</i></p>
View all active alarms, troubles, and supervisory signals	<p>The highest priority event will display first. Press the Down arrow to view location and type of alarm or trouble.</p> <div style="border: 1px solid black; padding: 5px; text-align: center; margin: 10px auto; width: fit-content;"> <pre style="font-family: monospace; font-size: 0.8em;"> FIRE: ALARM SUPERVISORY TROUBLE CO: ALARM SUPERVISORY EMERGENCY: ALARM SUPERVISORY <Press [Down Arrow] for status> </pre> </div>
View a Point's Status	<ol style="list-style-type: none"> 1. Press ENTER to access Main Menu. 2. Press 2 to select Point Functions. 3. Then press 2 to select Point Status. 4. Select the module the device is located on by using the Up or Down button. Then press ENTER. 5. Enter the point number.
Conduct a Fire Drill	<p>Hold the DRILL button and then enter a code if prompted. OR</p> <ol style="list-style-type: none"> 1. Enter the installer code. The panel will automatically go to the main menu. 2. Press 1 to select System Tests. 3. Enter code if prompted, then press 1 to select Fire Drill. 4. Press ENTER to start the fire drill, and Press ENTER to end the fire drill.
Set Time and Date	<ol style="list-style-type: none"> 1. Enter the installer code. The panel will automatically go to the main menu. 2. Press 4 to select Set Time & Date. Enter a code if prompted. 3. Make changes to the fields on the screen as necessary. 4. Press ENTER if you wish to keep the changes. 5. Press ENTER to set the entered time and date.
Enable / Disable a Point	<ol style="list-style-type: none"> 1. Enter the installer code. The panel will automatically go to the main menu. 2. Press 2 to select Point Functions. 3. Enter code if prompted, then press 1 to select Disable / Enable Point. 4. Press 7 to select Disable/Enable Point. 5. Select the module the point is located on by using the up or down arrow. Then press ENTER. 6. Enter the point number then press ENTER. 7. Press the right arrow to Disable/Enable Point.
To Gain /Request ECS Control	<ol style="list-style-type: none"> 1. Press the  Button and follow the on-screen Instructions. <p><i>Note: When ECS Control LED is blinking, another LOC has ECS Control. ECS Control LED is on steady when the LOC has ECS Control.</i></p>
For Service call:	

Cut Along the Dotted Line

Cut Along the Dotted Line

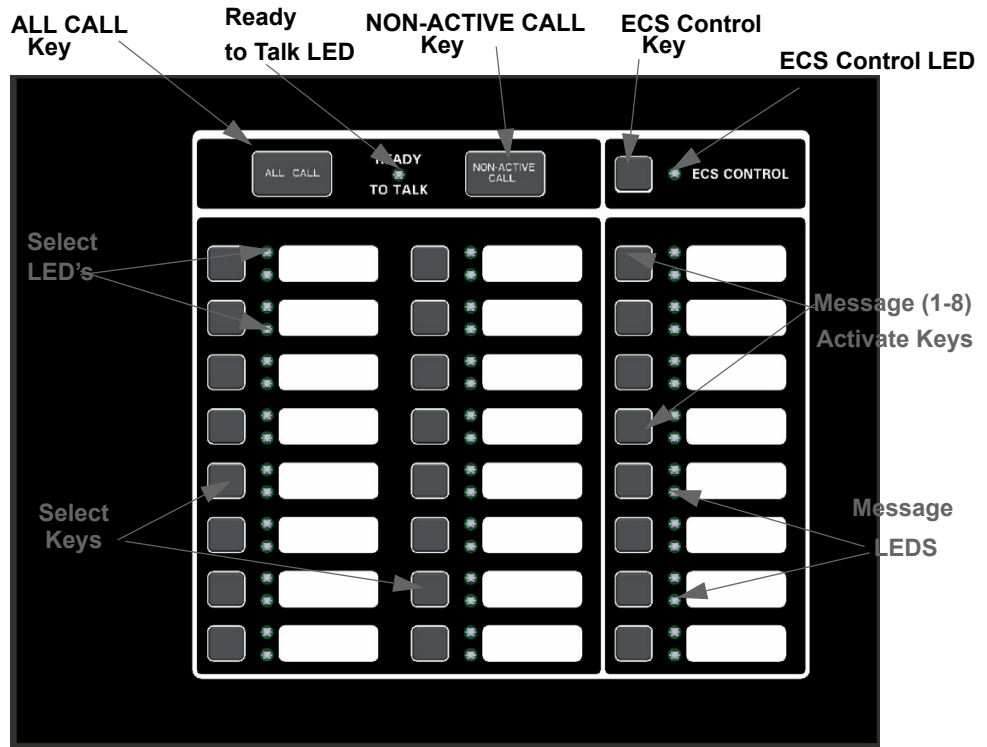

Figure 1-1: ECS Front view

Table 1-1: LED Conditions

LED	Color	States	Meaning
Select Keys	Red	On	The corresponding area is active for the currently playing ECS message.
		Off	The corresponding area is not active.
	Green	On	The corresponding area is active for the microphone.
		Off	The corresponding area is not active for the microphone.
		Blink	One or more associated network page destination panels are unable to output the page.
ECS Control LED	Green	Blink	When this LED is blinking, someone has requested control of the ECS System.
		On	LOC has ECS Control and the user is able to make changes to the ECS.
		Off	LOC does not have ECS Control.
ECS Message LED	Red	On	The corresponding ECS event was activated by an ECS device.
		Off	The corresponding ECS event was not activated from this LOC.
	Green	On	The corresponding ECS event is active and was generated from the LOC (or was activated from another LOC, but this LOC now has ECS Control).

Cut Along the Dotted Line

Table 1-2: ECS Control Request

Operation	Task
Gain ECS Control at an LOC	Press the ECS Control Key and enter a code if prompted. If ECS Control is available, the ECS Control LED will illuminate. If another LOC has ECS Control, the display will be similar to the one shown. Press 1 to request control. The LOC with ECS Control will then be able to allow or deny the request.
Gain ECS Control as ECS Super User at an LOC (only one ECS Super User is allowed ECS Control in the system at a time).	From the idle screen, enter an ECS Super User access code and then press the ECS Control Key. If ECS Control as Super User is available, the ECS Control LED will illuminate. If another LOC has Super User ECS Control, a request for Super User ECS Control will automatically be made to the LOC with control. The LOC with Super User ECS Control will then be able to allow or deny the request. (See Figure 1-2 for screen display example).
Select all output group for microphone override	Key the microphone, wait for the Ready-to-Talk LED to light, press the All Call Key, and then deliver your verbal message.
Select all non-activated output groups for microphone override	Key the microphone, wait for the Ready-to-Talk LED to light, press the Non-Active Call Key, and then deliver your verbal message.

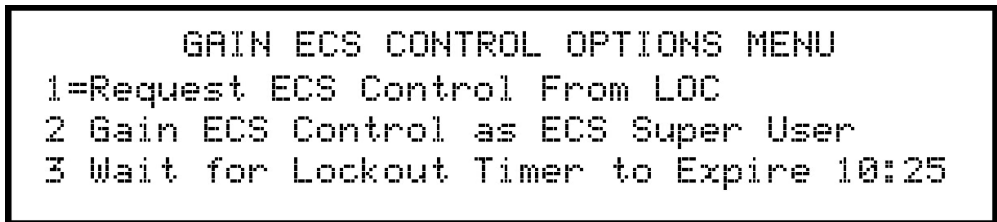

Figure 1-2: Gain ECS Control as ECS Super User Screen

How to Operate the Microphone:

1. Press the ECS Control button
2. Key the Microphone
3. Press the All Call button

How to Reset the ECS System

1. Press The Reset Button
2. Select 2 to Reset the Emergency system

ECS-LOC2100 Operating Instruction

For Live Message

1. Key the Microphone.
2. Press the All Call Key or select desired output area using select keys.
3. Deliver your verbal message.

For Pre-recorded Message

1. Select desired ECS Message Key 1-8.
 - If ECS Control LED is on steady, the LOC has ECS Control.
 - If ECS Control LED is Blinking, another LOC has ECS Control.

Cut Along the Dotted Line

Cut Along the Dotted Line

Honeywell Security & Fire
12 Clintonville Road
Northford, CT 06472-1610
203-484-7161
www.farenhyt.com

LS10143-001SK-E | C | 12/17
©2017 Honeywell International Inc.

Honeywell