

UNIFIED FACILITIES CRITERIA (UFC)

DESIGN AND O&M: MASS NOTIFICATION SYSTEMS



APPROVED FOR PUBLIC RELEASE; DISTRIBUTION UNLIMITED

UNIFIED FACILITIES CRITERIA (UFC)

MASS NOTIFICATION SYSTEMS

Any copyrighted material included in this UFC is identified at its point of use. Use of the copyrighted material apart from this UFC must have the permission of the copyright holder.

AIR FORCE CIVIL ENGINEER SUPPORT AGENCY (Preparing Activity)

NAVAL FACILITIES ENGINEERING COMMAND

U.S. ARMY CORPS OF ENGINEERS

Record of Changes (changes are indicated by \1\.../1/).

Change No.	Date	Location

FOREWORD

The Unified Facilities Criteria (UFC) system is prescribed by MIL-STD 3007 and provides planning, design, construction, sustainment, restoration, and modernization criteria, and applies to the Military Departments, the Defense Agencies, and the DoD Field Activities in accordance with [USD\(AT&L\) Memorandum](#) dated 29 May 2002. UFC will be used for all DoD projects and work for other customers where appropriate. All construction outside of the United States is also governed by Status of Forces Agreements (SOFA), Host Nation Funded Construction Agreements (HNFA), and in some instances, Bilateral Infrastructure Agreements (BIA). Therefore, the acquisition team must ensure compliance with the more stringent of the UFC, the SOFA, the HNFA, and the BIA, as applicable.

UFC are living documents and will be periodically reviewed, updated, and made available to users as part of the Services' responsibility for providing technical criteria for military construction. Headquarters, U.S. Army Corps of Engineers (HQUSACE), Naval Facilities Engineering Command (NAVFAC), and Air Force Civil Engineer Support Agency (AFCESA) are responsible for administration of the UFC system. Defense agencies should contact the preparing service for document interpretation and improvements. Technical content of UFC is the responsibility of the cognizant DoD working group. Recommended changes with supporting rationale should be sent to the respective service proponent office by the following electronic form: [Criteria Change Request \(CCR\)](#). The form is also accessible from the Internet sites listed below.

UFC are effective upon issuance and are distributed only in electronic media from the following source:

- Whole Building Design Guide web site <http://dod.wbdg.org/>.

Hard copies of UFC printed from electronic media should be checked against the current electronic version prior to use to ensure that they are current.

AUTHORIZED BY:

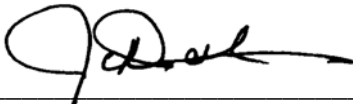

JAMES C. DALTON, P.E.
Chief, Engineering and Construction
U.S. Army Corps of Engineers



PAUL A. PARKER
The Deputy Civil Engineer
DCS/Logistics, Installations & Mission Support
Department of the Air Force



JOSEPH E. GOTT, P.E.
Chief Engineer and Director,
Capital Improvements, Acting
Naval Facilities Engineering Command

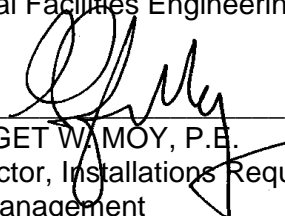

Dr. GET W. MOY, P.E.
Director, Installations Requirements and
Management
Office of the Deputy Under Secretary of Defense
(Installations and Environment)

**UNIFIED FACILITIES CRITERIA (UFC)
REVISION SUMMARY SHEET**

Document: UFC 4-021-01

Superseding: UFC 4-021-01, dated 18 December 2002

Description of Changes: This revision to UFC 4-021-01 incorporates new mass notification system (MNS) design requirements for the Air Force, Army, Marine Corps, and Navy. Design figures were changed accordingly. Criteria were added approving the use of combined MNS and fire alarm systems in some facilities. Chapters were added on wide area MNS, operational characteristics, and special considerations. Sample pre-recorded MNS messages were added in Appendix B. Progress towards incorporation of Internet capability into DOD mass notification is discussed in Appendix C.

Reasons for Changes:

- Incorporate lessons learned from field experience since the initial revision of this UFC in 2002.
- Achieve consistency with new national consensus standards for MNS.
- Incorporate Marine Corps MNS requirements into one consolidated manual.
- Comply with the new format for Security Engineering UFC series documents.

Impact: There are negligible cost impacts; however, these benefits should be realized:

- Simplify construction and avoid installation costs in many new and renovated facilities by permitting combined MNS and fire alarm systems.
- Simplify procurement of MNS equipment by requiring consistency with national consensus standards for MNS.
- Ensure that future MNS will coordinate with the new national “public alert and warning system” required by Executive Order 13407 of 28 June 2006.

CONTENTS

	<u>Page</u>
CHAPTER 1: INTRODUCTION.....	1
1-1 BACKGROUND	1
1-2 PURPOSE	1
1-3 SCOPE	1
1-3.1 Applicability.....	1
1-3.2 Service Exception	1
1-3.3 Compliance with Technical Criteria.....	2
1-3.4 Authority having Jurisdiction (AHJ)	2
1-3.5 Waivers.....	2
1-3.6 Implementation	2
1-3.7 Responsibilities	2
1-3.8 Retroactivity	3
1-4 REFERENCES	3
1-5 QUALIFICATIONS OF SUPPLIERS AND CONTRACTORS	3
1-5.1 System Integrators and Contractors	3
1-5.2 Mass Notification System Component Products and Manufacturers	3
1-5.3 Performance and Acceptance Testing	3
1-5.4 Installation Records	3
1-6 SECURITY ENGINEERING UFC SERIES	3
1-6.1 DOD Minimum Antiterrorism Standards for Buildings	4
1-6.2 Security Engineering Facilities Planning Manual	4
1-6.3 Security Engineering Facilities Design Manual	4
1-6.4 Security Engineering Support Manuals.....	4
CHAPTER 2: OVERVIEW OF SYSTEMS.....	6
2-1 SCOPE	6
2-2 CAPABILITY	6
2-3 LIFE SAFETY SYSTEMS	6
2-4 ACCESSIBILITY	6
2-5 PUBLIC ALERT AND WARNING SYSTEM	6
2-6 SYSTEM TYPES	6
2-6.1 Wide Area MNS	6
2-6.2 Individual Building MNS	7
CHAPTER 3: WIDE AREA MNS	9
3-1 SCOPE	9
3-2 REQUIREMENTS FOR SYSTEM DESIGNERS.....	9
3-2.1 Designer Qualifications	9
3-2.2 System Integrators and Contractors	9
3-3 SYSTEM SIGNALS.....	10
3-3.1 Voice Signals	10
3-3.2 Music	10
3-3.3 Tones.....	10

3-4	SUBSYSTEMS	10
3-4.1	Central Control Stations.....	10
3-4.2	HPSA	10
3-4.3	Communications Links.....	10
3-4.4	Ancillary Equipment.....	10
3-5	CENTRAL CONTROL STATIONS.....	10
3-5.1	Locations	10
3-5.2	On-Installation Control	11
3-5.3	Off-Installation Interfaces.....	11
3-5.4	Central Control Station Requirements	11
3-6	HPSA	14
3-6.1	Arrangement in Zones	14
3-6.2	Directional Characteristics	14
3-6.3	Outdoor Areas	14
3-6.4	Special Outdoor Areas (Army and Air Force Projects).....	15
3-6.5	Occupational Noise Exposure.....	16
3-6.6	Noise Pollution.....	16
3-6.7	HPSA Inside of Buildings.....	17
3-6.8	HPSA Speaker Sites.....	17
3-6.9	HPSA Performance.....	17
3-6.10	Temperature Rating.....	19
3-6.11	Battery Backup Power	19
3-6.12	Connection to Portable Electrical Power Generator.....	19
3-6.13	Elevated Supporting Structure	19
3-6.14	HPSA Attached to Buildings	20
3-7	COMMUNICATIONS LINKS	20
3-7.1	Primary Communications Link	20
3-7.2	Redundant Communications Link	21
3-7.3	Off-the-Shelf Equipment	21
3-7.4	Supervision	22
3-7.5	Diagnostics	22
3-7.6	Interfaces with Other Systems	22
CHAPTER 4: INDIVIDUAL BUILDING MNS FOR NEW CONSTRUCTION PROJECTS.....		23
4-1	SCOPE	23
4-2	REQUIREMENTS FOR SYSTEM DESIGNERS.....	23
4-3	SYSTEM OVERVIEW	23
4-3.1	Subsystems	23
4-3.2	ACU	24
4-3.3	LOC	24
4-3.4	Notification Appliance Network	24
4-3.5	Interfaces with the Wide Area MNS	25
4-3.6	Logical Block Diagrams	25
4-4	ACU	29
4-4.1	Locations	29
4-4.2	Design Features	29

4-4.3	Off-the-Shelf Equipment	32
4-4.4	Programming Codes	32
4-4.5	Power Supply Features.....	32
4-5	LOC	32
4-5.1	Locations	32
4-5.2	Design Features	33
4-6	NOTIFICATION APPLIANCE NETWORK	34
4-6.1	Audible Appliance Network.....	34
4-6.2	Visual Appliance Network	37
4-7	INTERFACES WITH WIDE AREA MNS	38
CHAPTER 5: INDIVIDUAL BUILDING MNS FOR RENOVATION PROJECTS		39
5-1	SCOPE	39
5-2	REQUIREMENTS FOR SYSTEM DESIGNERS.....	39
5-3	USE OF NEW CONSTRUCTION CRITERIA.....	39
5-3.1	FACP Replacement: No Existing MNS in Building.....	39
5-3.2	FACP Replacement: Existing MNS in Building	39
5-3.3	MNS Installation Projects.....	40
5-4	SYSTEM OVERVIEW	40
5-4.1	Subsystems	40
5-4.2	ACU	40
5-4.3	LOC	40
5-4.4	Notification Appliance Network	40
5-4.5	Interfaces with Facility FACP	41
5-4.6	Interfaces with Facility PA System.....	42
5-4.7	Interfaces with the Wide Area MNS	42
5-4.8	Logical Block Diagrams	43
5-5	ACU	51
5-5.1	Location	51
5-5.2	Design Features	51
5-5.3	Off-the-Shelf Equipment	53
5-5.4	Programming Codes.....	54
5-5.5	Power Supply Features.....	54
5-6	LOC	54
5-6.1	Locations	54
5-6.2	Design Features	55
5-7	NOTIFICATION APPLIANCE NETWORK	56
5-7.1	Audible Appliance Network.....	56
5-7.2	Visual Appliance Network	58
5-8	INTERFACES WITH WIDE AREA MNS	60
CHAPTER 6: SPECIAL CONSIDERATIONS.....		61
6-1	OVERVIEW.....	61
6-2	IMPLEMENTATION PLAN.....	61
6-3	GIANT VOICE SYSTEM	61
6-4	TELEPHONE ALERTING SYSTEM.....	61
6-5	SPECIAL OCCUPANCIES.....	62
6-5.1	No Self-Preservation Capability	62

6-5.2	Not Occupied by Hearing Impaired Persons	62
6-5.3	Housing and Lodging Facilities	62
CHAPTER 7: OPERATIONAL CHARACTERISTICS		64
7-1	INTRODUCTION	64
7-2	WIDE AREA MNS	64
7-2.1	Central Control Stations	64
7-2.2	Regional or National Command Centers	64
7-2.3	Public Alert and Warning System	64
7-2.4	HPSA	64
7-2.5	Supplemental Mass Notification Delivery Systems	65
7-3	INDIVIDUAL BUILDING MNS	65
7-3.1	Combined Systems	65
7-3.2	LOC	65
7-3.3	ACU	65
7-3.4	Notification Appliances	65
CHAPTER 8: MAINTENANCE		67
8-1	INTRODUCTION	67
8-2	MAINTENANCE RESPONSIBILITIES	67
8-2.1	Air Force	67
8-2.2	Marine Corps	67
8-3	QUALIFICATIONS OF MAINTENANCE PERSONNEL	67
8-3.1	Inspection, Testing, and Maintenance Tasks	67
8-3.2	Other Inspections	68
8-3.3	Maintenance Records	68
8-4	INDIVIDUAL BUILDING MNS	68
8-5	WIDE AREA MNS	68
GLOSSARY		71
APPENDIX A: REFERENCES		75
APPENDIX B: SAMPLE PRE-RECORDED MESSAGES		79
APPENDIX C: NET-CENTRIC ALERTING SYSTEMS (NCAS)		84

FIGURES

Figure 4-1. Individual Building Mass Notification System: Combination Fire Alarm System and MNS (Navy)	27
Figure 4-2. Individual Building Mass Notification System: Combination Fire Alarm System and MNS (Army and Air Force)	28
Figure 5-1. Individual Building Mass Notification System: Separate Fire Alarm System and MNS (Navy)	44
Figure 5-2. Individual Building Mass Notification System: Separate Fire Alarm System and MNS (Army and Air Force)	45

Figure 5-3. Individual Building Mass Notification System: Separate Fire Alarm System and MNS (Marine Corps) 46

Figure 5-4. Individual Building Mass Notification System: Speakers Shared by Fire Alarm System and MNS (Navy) 47

Figure 5-5. Individual Building Mass Notification System: Speakers Shared by Fire Alarm System and MNS (Army and Air Force)..... 48

Figure 5-6. Use of Existing Public Address System: Navy 49

Figure 5-7. Use of Existing Public Address System: Army and Air Force..... 50

TABLES

Table 8-1. Central Control Unit Maintenance 68

Table 8-2. Communications Network Maintenance 70

CHAPTER 1

INTRODUCTION

1-1 **BACKGROUND.** Mass notification provides real-time information and instructions to people in a building, area, site, or installation using intelligible voice communications along with visible signals, text, and graphics, and possibly including tactile or other communication methods. The purpose of mass notification is to protect life by indicating the existence of an emergency situation and instructing people of the necessary and appropriate response and action.

This Unified Facilities Criteria (UFC) was developed by collecting and refining criteria from Department of Defense (DOD) antiterrorism guidance, examining previous mass notification system (MNS) evaluation reports, and reviewing the capabilities of representative, commercially available MNS and products.

1-2 **PURPOSE.** This UFC provides technical criteria for systems that will:

- Implement mass notification in compliance with the DOD antiterrorism requirements as specified in UFC 4-010-01
- Implement national design standards and recommendations for mass notification systems as provided in National Fire Protection Association (NFPA) Standard 72 (including Annex E)
- Achieve coordination of DOD mass notification capabilities with national systems as required by Executive Order 13407

1-3 **SCOPE.** This UFC provides the design, operation, and maintenance requirements of MNS for DOD facilities. The requirement for a MNS is established by UFC 04-010-01. This document is intended to assist in the design of systems that meet the requirement established by UFC 04-010-01 and to give guidance to commanders, architects, engineers, and end users on design, operation, and maintenance of MNS.

1-3.1 **Applicability.** This UFC applies to new construction, major renovations, and leased buildings and must be used in accordance with the applicability requirements of UFC 4-010-01 or as directed by service guidance. See UFC 4-010-01 for more information on the applicability requirements.

1-3.2 **Service Exception.** Where one or more service's criteria vary from the other services' criteria, it is noted in the text with the  (Service Exception) symbol.

1-3.3 **Compliance with Technical Criteria.** Do not deviate from the technical criteria of this UFC without prior approval from the component office of responsibility:

- U.S. Air Force: Air Force Civil Engineer Support Agency, Operations and Programs Support Directorate (HQ AFCESA/CEO)
- U.S. Army: U.S. Army Corps of Engineers, Directorate of Civil Works, Engineering and Construction (HQ USACE/CECW-CE)
- U.S. Navy: Naval Facilities Engineering Command, Headquarters Chief Engineer's Office (NAVFACENGCOM HQ Code CHE)
- U.S. Marine Corps (HQMC), Code PS and Code LFF-1
- Defense Logistics Agency Director (HQ DLA-D) through Support Services (DLA-DES-SE)
- National Geospatial-Intelligence Agency (NGA), Security and Installations
- Other DOD components: the Office of the Deputy Under Secretary of Defense (Installations & Environment) (DUSD [I&E]) via the DOD Committee on Fire Protection Engineering

1-3.4 **Authority having Jurisdiction (AHJ).** The component office of responsibility listed in paragraph 1-3.3 is also referred to in this UFC as the AHJ.

1-3.5 **Waivers and Exemptions.** The AHJ may approve waivers and exemptions to the technical criteria of this UFC only. Waivers and exemptions shall comply with the requirements of military standard (MIL-STD) 3007.

1-3.6 **Implementation.** Implementation of an effective MNS will require the coordinated efforts of engineering, communications, and security personnel. Fire protection engineering personnel are needed for the successful implementation of this UFC because they bring a special expertise in life safety evaluations, building evacuation systems, and the design of public notification systems. Coordination with communications personnel is required when the MNS is connected to the DOD installation's communications infrastructure. The designated first responders of the DOD installation are ultimately responsible for the protection of building occupants, and will be the primary users of an individual building MNS. Designated security or command personnel will be the primary users of a wide area MNS and should recommend installation projects, oversee access control, update central control system mapping and, as necessary, develop associated local recipient groups for targeted notification.

1-3.7 **Responsibilities.** DOD does not mandate which organizations are responsible for funding, operation, or maintenance of MNS installed in accordance with UFC 4-010-01; each DOD component must assign those

responsibilities.

1-3.8 **Retroactivity.** Existing MNS installed in compliance with an earlier version of this UFC do not have to be modified to meet the requirements of the current edition of this UFC; however, any alteration or any installation of new equipment shall meet, as nearly as practicable, the requirements for new MNS.

1-4 **REFERENCES.** See Appendix A.

1-5 **QUALIFICATIONS OF SUPPLIERS AND CONTRACTORS**

1-5.1 **System Integrators and Contractors.** Use system integrators and contractors that are able to demonstrate a full knowledge and understanding of systems used for mass notification, and that have factory-trained personnel to perform system design, installation, testing, training, and maintenance.

1-5.2 **MNS Component Products and Manufacturers.** Only accept products from manufacturers that can meet the design criteria of this UFC and can demonstrate five years of experience in producing products similar to those required for mass notification. Use products of current manufacture with replacement parts and components available for a minimum of ten years.

1-5.3 **Performance and Acceptance Testing**

1-5.3.1 Upon completion of the installation, the contractor must complete performance testing of the MNS for compliance with this UFC. Verification of performance testing will be checked by local representatives of the AHJ. Performance results, including the required sound pressure levels and intelligibility values, shall be documented and submitted to the AHJ with notation of any deficiencies and corrective actions.

Note: The AHJ are those component offices of responsibility listed in paragraph 1-3.3 (see paragraph 1-3.4).

1-5.3.2 Upon successful completion of performance testing, the contractor must complete a witnessed acceptance test. Acceptance testing will be witnessed by local representatives of the AHJ. (See paragraph 1-3.4 for more information on the AHJ.)

1-5.4 **Installation Records.** The contractor must provide a complete set of record drawings and operations and maintenance manuals for the MNS. Record drawings and operations and maintenance manuals must provide information for troubleshooting, preventive maintenance, and corrective maintenance.

1-6 **SECURITY ENGINEERING UFC SERIES.** This UFC is one of a series of security engineering UFC documents that cover minimum standards, planning, preliminary design, and detailed design for security and antiterrorism. The manuals in this series are designed to be used sequentially by a diverse audience to facilitate development of projects throughout the design cycle. The

manuals in this series include:

1-6.1 DOD Minimum Antiterrorism Standards for Buildings.

UFC 4-010-01 and 4-010-02 establish standards that provide minimum levels of protection against terrorist attacks for the occupants of all inhabited DOD buildings. These UFC are intended to be used by security and antiterrorism personnel and design teams to identify the minimum requirements that must be incorporated into the design of all new construction and major renovations of inhabited DOD buildings. These UFC also include recommendations for designs that should be, but are not required to be, incorporated into all such buildings.

1-6.2 Security Engineering Facilities Planning Manual. UFC 4-020-01FA presents processes for developing the design criteria necessary to incorporate security and antiterrorism measures into DOD facilities and for identifying the cost implications of applying those design criteria. These design criteria may be limited to the requirements of the minimum standards, or they may include protection of assets other than those addressed in the minimum standards (people), aggressor tactics that are not addressed in the minimum standards, or levels of protection beyond those required by the minimum standards. The cost implications for security and antiterrorism are addressed as cost increases over conventional construction for common construction types. The changes in construction represented by those cost increases are tabulated for reference, but they represent only representative construction that will meet the requirements of the design criteria. The manual also addresses the tradeoffs between cost and risk. UFC 4-020-01FA is intended to be used by planners as well as security and antiterrorism personnel with support from planning team members.

1-6.3 Security Engineering Facilities Design Manual. UFC 4-020-02FA provides interdisciplinary design guidance for developing preliminary systems of protective measures to implement the design criteria established in UFC 4-020-01FA. Those protective measures include building and site elements, equipment, and the supporting manpower and procedures necessary to make them work as a system. The information in UFC 4-020-02FA is in sufficient detail to support concept-level project development, and as such can provide a good basis for a more detailed design. The manual also provides a process for assessing the impact of protective measures on risk. The primary audience for UFC 4-020-02FA is the design team, but the UFC can also be used by security and antiterrorism personnel.

1-6.4 Security Engineering Support Manuals. In addition to the standards, planning, and design UFC discussed in paragraphs 1-6.1 through 1-6.3, a series of additional UFC documents is planned that will provide detailed design guidance for developing final designs based on the preliminary designs developed using UFC 4-020-02FA. These support manuals will provide specialized, discipline-specific design guidance. Some will address specific tactics such as direct-fire weapons, forced entry, or airborne contamination. Others will address limited aspects of design such as resistance to progressive collapse or the design of portions of buildings such as mailrooms. Still others will

address details of designs for specific protective measures such as vehicle barriers or fences. The security engineering support manuals are intended to be used by the design team during the development of final design packages.

CHAPTER 2

OVERVIEW OF SYSTEMS

2-1 **SCOPE.** This chapter includes important definitions and provides an overview of MNS.

2-2 **CAPABILITY.** Mass notification provides real-time information and instructions to people in a building, area, site, or DOD installation using intelligible voice communications along with visible signals, text, and graphics, and possibly including tactile or other communication methods. MNS are intended to protect life by indicating the existence of an emergency situation and instructing people of the necessary and appropriate response and action.

2-3 **LIFE SAFETY SYSTEMS.** MNS are designated as life safety systems in a manner similar to DOD-required fire protection systems.

2-4 **ACCESSIBILITY.** Compliance with Uniform Federal Accessibility Standards (UFAS) for MNS is required. Visual alarm notification appliances shall be provided inside of buildings for hearing impaired persons when new MNS are installed. Providing visual alarm notification appliances is required for DOD compliance with Executive Order 13347.

2-5 **PUBLIC ALERT AND WARNING SYSTEM.** Coordination of MNS with national alert and warning systems is required for DOD compliance with Executive Order 13407.

2-6 **SYSTEM TYPES**

Note: See Appendix C for a discussion of Internet-based alerting systems.

2-6.1 **Wide Area MNS.** Wide area MNS are installed to provide real-time information to outdoor areas of a DOD installation. These systems are normally provided with and operated from two or more central control stations. Communications between central control stations and individual building MNS is provided. Communications between the central control stations and regional or national command systems may also be provided. The requirements to install wide area MNS are specific to each DOD component. A general DOD requirement to install these systems on all DOD installations has not yet been established.

2-6.1.1 **Interconnection with Individual Building MNS.** The wide area MNS manufacturer shall provide a standard interface method (such as an audio line-level output and multiple relay contacts) or supply the necessary digital communication protocols to permit the DOD installation to select more than one manufacturer of individual building MNS. Depending on system architecture, the

manufacturer may be required to provide a system Internet Protocol (IP) interface capable of allowing data transfer from an outside source to internal mass notification functions via a common data communications protocol.

2-6.1.2 **Army Installations.** Wide area MNS shall be installed on Army installations in accordance with Army Chief of Staff antiterrorism guidance.

2-6.1.3 **Air Force Installations.** A wide area MNS shall be a component of and connected to the installation notification and warning system (INWS) as defined by Air Force instruction (AFI) 10-2501. The INWS typically includes a “giant voice” system for outdoor notification of personnel.

2-6.1.4 **Marine Corps Installations.** Wide area MNS shall be installed on Marine Corps installations in accordance with the most current edition of Marine Corps Order (MCO) 5530.14 and MCO 3302.1.

Note: Marine Corps designs use central control stations shared by both the wide area MNS and the individual building MNS.

2-6.1.5 **Navy Installations.** Wide area MNS shall be installed on Navy installations in accordance with Chief of Naval Operations (CNO) antiterrorism guidance.

2-6.2 **Individual Building MNS.** Individual building MNS are installed to provide real-time information to all building occupants or personnel in the immediate vicinity of a building, including exterior egress and gathering areas. These systems are designed to operate from one or more locations in the building, and operate with or without connection to a wide area MNS—but must be connected to with the wide area MNS if one is provided on the DOD installation. All DOD components are required to provide individual building mass notification capability.

 Marine Corps individual building MNS are not required to provide the capability to initiate messages from any location within the individual building.

Note: Marine Corps designs use central control stations shared by both the wide area MNS and the individual building MNS.

2-6.2.1 **DOD Requirements.** The DOD must provide mass notification for new and existing buildings when required by UFC 4-010-01. Mass notification is required in all new inhabited buildings, including new primary gathering buildings and new billeting. Mass notification is required in existing primary gathering buildings and existing billeting when implementing a project exceeding the replacement cost threshold specified in UFC 4-010-01 or when prioritized by local command personnel. Mass notification is recommended in other existing inhabited buildings when implementing a project not exceeding the replacement cost threshold. Mass notification is required for leased buildings, building additions, and expeditionary and temporary structures.

Note: UFC 4-010-01 provides specific definitions of inhabited buildings, primary gathering buildings, and billeting for application of antiterrorism requirements.

CHAPTER 3

WIDE AREA MNS

3-1 **SCOPE.** Wide area MNS are intended to provide real-time information to outdoor areas of a DOD installation. Small facilities that are exempted by UFC 4-010-01 from providing individual building MNS could be covered by a wide area MNS. These facilities could include buildings such as single-family and duplex military family housing, individual lodging buildings housing 10 occupants or less, shoppettes, automobile service stations, storage buildings with very low density of occupancy, and military family campgrounds. The requirements to install wide area MNS are specific to each DOD component. A general DOD requirement to install these systems on all DOD installations has not been established.

3-2 REQUIREMENTS FOR SYSTEM DESIGNERS

3-2.1 **Designer Qualifications.** The wide area MNS shall be designed under the supervision of a registered professional engineer with a minimum of four years' current work experience in fire protection, electrical, and communication-electronics engineering areas specific to wide area MNS. Alternately, the wide area MNS may be designed by an engineering technologist verified by the National Institute for Certification in Engineering Technologies (NICET) as certified at Level IV in low voltage electronic-communications systems or Level IV in fire alarm systems, plus this engineering technologist shall possess a minimum of four years' current work experience specific to wide area MNS communications-electronics. Alternately, the wide area MNS may be designed by an engineering technologist that possesses a minimum of ten years' documented current work experience specific to wide area MNS communications-electronics. The speaker array supporting structure shall be designed by a registered professional structural engineer to resist all environmental loads, including site-specific wind and seismic forces. The individual's name, signature, and professional engineer number or NICET certification number (when applicable) shall be included on all final design documents.

3-2.2 **System Integrators and Contractors.** Use system integrators and contractors that can demonstrate a full knowledge and understanding of systems used for mass notification, and that have factory-trained personnel to perform system design, installation, testing, training, and maintenance.

Note: The MNS designer should have demonstrated expertise in audio system design, sound pressure and intelligibility measurement and evaluation, radio communications systems, audible and visual notification appliances, and central control station designs.

3-3 **SYSTEM SIGNALS.** Wide area MNS shall include an outdoor speaker and siren system providing voice signals, music, and alarm tones.

3-3.1 **Voice Signals.** Wide area MNS shall be capable of providing intelligible live and pre-recorded voice signals.

3-3.2 **Music.** Wide area MNS shall be capable of providing music such as the national anthem and other musical signals such as Attention to Colors, Reveille, and Taps.

3-3.3 **Tones.** Wide area MNS shall be provided with standard Federal Emergency Management Agency (FEMA) weather warning tones. Military-specific warning tones shall be provided as specified by the DOD installation, and should include tones for conventional attack warning, non-conventional attack warning, all clear, and a system test tone. Such tones should be similar to Civil Defense tones originally developed during World War II and the Cold War era.

3-4 **SUBSYSTEMS.** Wide area MNS includes several subsystems: central control stations; high power speaker arrays (HPSA); communication links; and ancillary equipment.

3-4.1 **Central Control Stations.** These stations operate and control the system.

3-4.2 **HPSA.** The speakers are used to provide the sound signals to the outdoor locations on the DOD installation.

3-4.3 **Communications Links.** Communications links are used for sending signals between the central control stations and the HPSA, and between the central control stations and regional or national command centers. A redundant (backup) means of communication shall be provided unless the primary means of communication is highly reliable, well protected, and constantly monitored by the central control station for operational status.

Note: See Appendix C for a discussion of requirements for Internet-based communication systems (under development).

3-4.4 **Ancillary Equipment.** This equipment includes items such as aircraft obstruction lights, anti-nesting spikes, and meters to meet local DOD installation requirements.

3-5 **CENTRAL CONTROL STATIONS.** The wide area MNS shall be provided with at least one primary and one redundant central control station.

3-5.1 **Locations.** The locations of the central control stations shall be coordinated with the first responders on each DOD installation. The primary central control station should be located at the installation control center (ICC),

command post, emergency operations center (EOC), or similar location. The redundant central control center should be located at a physically separate location such as a security forces building, military police station, fire station, or director of emergency services office.

SE Marine Corps primary central control stations should be located at a security forces or military police dispatch center, and the redundant central control center should be located at the ICC, EOC, operations center, or similar location.

3-5.2 On-Installation Control. The central control stations shall control the operation of outdoor speakers on the DOD installation. Communications shall be provided between the central control stations and individual building MNS. The wide area MNS shall have the capability to communicate with other notification systems on the DOD installation such as the telephone alerting system, paging system, commander's channel on public access television stations, and highway advisory radio and sign control system (used for dynamic control of radio information and traffic signs for emergency information and traffic management).

SE Communication with other notification systems is not required for Marine Corps systems.

3-5.3 Off-Installation Interfaces. Communications between the central control stations and regional or national command systems shall be provided. This shall include the receipt, recording, and distributing of voice messages and alert signals received from the Commander in Chief through the national public alert and warning system.

3-5.4 Central Control Station Requirements. The central control unit shall consist of these components and features:

3-5.4.1 Graphical User Interface (GUI). This should be a computer interface with sufficient capability to operate the system with easy point and click operations.

3-5.4.2 Backup Power. Each central control station shall be equipped with batteries to supply power for a minimum of 4 hours of full-load operation when the central control station is provided with a permanently installed backup electrical power generator. This electrical power generator need not be dedicated solely to the central control station but may be intended to supply other important electrical loads in addition to the central control station. If not provided with a permanently installed backup electrical power generator, a portable backup electrical power generator may be used if procedures are established that ensure that the central control station is provided with electrical power within 4 hours.

3-5.4.3 Inputs. The central control station must provide capability for at least these features:

3-5.4.3.1 Total, zone, and single voice activations

3-5.4.3.2 Total, zone, and single tone activations

3-5.4.3.3 Total, zone, and single music activations

3-5.4.3.4 Total, zone, and single tests

3-5.4.3.5 Total, zone, and single signal cancellations

3-5.4.3.6 Automatic status reporting for each HPSA and for all activations and the status of the activations

3-5.4.3.7 Alarm summary report that provides a historical report for, at least, all changes of status, including all troubles, equipment failure, power system trouble (including normal and emergency power), unsolicited messages, tamper/supervision of the enclosure for the HPSA electronics, amplifier status, last activation and synchronization error, operator log on and log off, and configurable reports for time-based events such as "report all troubles from 1/01/04 to 6/30/04."

3-5.4.3.8 Communications logs in tabular format

3-5.4.3.9 Screen displays of the customized DOD installation maps showing the general status of the speakers or remote equipment. This GUI shall provide for easy uploading of DOD installation-specific plan changes and for interactive operation.

Note: The DOD installation should specify the source of maps used by the GUI.

Note: Automatic recognition and display of new speakers, new remote equipment, and newly connected individual building MNS is available for some digital control systems. This feature, if provided, can significantly reduce system maintenance costs for the DOD installation.

3-5.4.3.10 Global Positioning System (GPS) coordinates of HPSA and facilities provided with an individual building MNS

3-5.4.3.11 Multiple levels of password protection, including levels for system operators, maintainers, supervisors, and military commanders, at a minimum

3-5.4.3.12 The ability to record and send digital messages to the HPSA via the primary (and redundant, if provided) communication link and to receive confirmation that the messages were received and stored at the HPSA. Alternately, the DOD installation may authorize use of fixed, pre-recorded emergency messages that are physically installed in each HPSA (typically by installing an erasable programmable read-only memory (EPROM) or flash memory device).

3-5.4.3.13 The capability to connect to and control message signs to direct vehicular traffic on roadways

 Not required for Marine Corps systems

3-5.4.3.14 The capability to deliver at least two essentially concurrent voice messages: one for threatened areas or buildings and one for adjacent areas or buildings. This includes the capability for two pre-recorded voice messages, or one live and one pre-recorded voice message.

 Marine Corps systems may deliver sequential voice messages (at least 2) instead of at least 2 concurrent voice messages.

3-5.4.3.15 The capability to target specific messages to any individual HPSA, zone of HPSAs, or to all areas on the DOD installation

3-5.4.3.16 Means for dynamic or “on-the-fly” configuration of zoning, with a minimum of 8 zones available

3-5.4.3.17 Secure method for easily creating or modifying recorded messages

3-5.4.3.18 The capability to store at least 60 minutes of pre-recorded messages

3-5.4.3.19 The capability to deliver text pager messages to pager stations

 Not required for Marine Corps systems

3-5.4.3.20 The capability to deliver faxes

 Not required for Marine Corps systems

3-5.4.3.21 The capability to connect to Reverse 911® systems and other telephone dialing/notification systems

 Not required for Marine Corps systems

3-5.4.3.22 Microphone for live voice announcements

3-5.4.3.23 The capability to perform silent tests, including a test of the amplifiers, controllers, and sound drivers, and tests to verify that communications are operational

3-5.4.3.24 The capability to control individual speaker zones of those HPSAs designated by the DOD installation

 Not required for Marine Corps systems

3-5.4.3.25 The capability to receive, record, and broadcast throughout the DOD installation all voice messages and alert signals received from the Commander-in-Chief through the national public alert and warning system. This

will include the capability to immediately broadcast the messages and signals without a noticeable time delay, and the capability to delay the broadcast so not to interfere with operational requirements when so authorized by the DOD installation commander.

3-6 HPSA

3-6.1 **Arrangement in Zones.** HPSAs shall be arranged into zones so that each zone can be individually controlled by the control station.

3-6.2 **Directional Characteristics.** HPSAs shall be designed with directional characteristics that will minimize the distortion of voice signals by interface from other zones, and will minimize the transmission of voice, siren, or other sound signals into environmentally sensitive areas or off the DOD installation.

Note: HPSAs with omnidirectional (i.e., approximately spherical shape) sound transmission characteristics may be considered for specific areas of the installation but should be used only for isolated areas having minimal concern for mutual interference between HPSA zones, when local operation of the HPSA is not required by the DOD installation, when Occupational Safety and Health Administration (OSHA) noise exposure levels will not be exceeded beneath the HPSA, and when omnidirectional speakers can be shown to be the most cost effective design.

 Marine Corps systems will primarily use omnidirectional, 360-degree coverage HPSAs and speaker towers to maximize the alerting coverage area; however, directional speaker towers may be used as needed to minimize off-base or host nation disturbances.

3-6.3 **Outdoor Areas.** HPSAs shall be designed to maintain the intelligibility of voice signals within the zone at a level no less than 0.7 on the Common Intelligibility Scale (CIS) or 0.5 on the Speech Transmission Index (STI) measure in outdoor areas during normal weather conditions. Intelligibility may be less than 0.7 CIS in areas of the zone if personnel can determine that a voice signal is being broadcast and they could walk less than 50 meters (m) (164 feet (ft)) to find a location in the zone with at least 0.7 CIS.

Note: Values of 0.65 through 0.74 will be rounded to 0.7.

Note: Physical limitations in outdoor sound propagation normally limit the maximum distance of personnel from the sound system speaker to the range of about 550 to 610 m (1800 to 2000 ft) for the receipt of an intelligible voice message. Increases in speaker output power may extend the sound wave propagation distance but often cause excessive distortion of the voice message and decrease intelligibility to unacceptably low levels.

Note: Commercially available test instrumentation should be used to measure intelligibility using the CIS as specified by International Electrotechnical

Commission (IEC) 60849 and IEC 60268-16. Alternately, trained human speakers and listeners may be used to measure intelligibility using the STI as specified in American National Standards Institute (ANSI) 3.2. The mean value of at least 3 readings is required to compute the intelligibility score at each test location when using the test instrumentation method.

Note: Normal weather conditions should be specified by the DOD installation as appropriate for its geographic location. Intelligibility meters with internal compensation should be used to adjust CIS measurements for other than normal weather conditions. Weather data for the DOD is maintained by the Air Force Combat Climatology Center and may be accessed for all DOD locations at <https://www2.afccc.af.mil/>. This site contains a database of engineering weather data that may be searched by installation or city name. Use of the average wind speed and direction data from the “Dry Bulb Temperature” section of the “Design Criteria Data” table is recommended.

3-6.4 Special Outdoor Areas (Army and Air Force Projects). HPSAs shall be designed to maintain the intelligibility of voice signals within the zone at a level no less than 0.8 CIS or 0.7 STI during normal weather conditions in special outdoor areas such as those with a high concentration of multi-story buildings in close proximity. Parade grounds, training fields, and similar outdoor areas should also be provided with this higher intelligibility. Many DOD installations contain one or more special outdoor areas. The boundaries of special outdoor areas shall be established by the DOD installation. Intelligibility may be less than 0.8 CIS in areas of the zone if personnel can determine that a voice signal is being broadcast and could walk less than 25 m (82 ft) to find a location in the zone with a CIS score of at least 0.8.

Note: Values of 0.75 through 0.84 will be rounded to 0.8.

Note: In special outdoor areas (such as in industrial areas with many multi-story buildings), the maximum distance of personnel from an outdoor speaker often has to be significantly reduced to retain acceptable intelligibility of the voice message. Speakers that provide directional capability should be used. These may be mounted on building exteriors if the speakers do not radiate unacceptable levels of sound into the building on which they are mounted.

Note: Physical limitations in outdoor sound propagation normally limit the maximum distance of personnel from the sound system speaker to the range of about 550 to 610 m (1800 to 2000 ft) for the receipt of an intelligible voice message. Increases in speaker output power may extend the sound wave propagation distance but often cause excessive distortion of the voice message and decrease intelligibility to unacceptably low levels.

Note: Commercially available test instrumentation should be used to measure intelligibility using the CIS as specified by IEC 60849 and IEC 60268-16. Alternately, trained human speakers and listeners may be used to measure intelligibility using the STI as specified in ANSI 3.2. The mean value of at least

three readings is required to compute the intelligibility score at each test location when using the test instrumentation method.

Note: Normal weather conditions should be specified by the DOD installation as appropriate for its geographic location. Intelligibility meters with internal compensation should be used to adjust CIS measurements for other than normal weather conditions. Weather data for the DOD is maintained by the Air Force Combat Climatology Center and may be accessed for all DOD locations at <https://www2.afccc.af.mil/>. This site contains a database of engineering weather data that may be searched by installation or city name. Use of the average wind speed and direction data from the “Dry Bulb Temperature” section of the “Design Criteria Data” table is recommended.

3-6.5 **Occupational Noise Exposure.** It is necessary to control the occupational noise exposure to personnel from the HPSA to comply with Federal regulations (Title 29, Code of Federal Regulations, Parts 1910.95 and 1926.52). Sound levels at any location where personnel may be located, including directly underneath the HPSA, shall not exceed 120 decibels (adjusted) (dBA) when measured on the A-scale of a standard sound level meter at slow response. Do not exceed 85 dBA at the location of the individual HPSA equipment cabinet for those HPSAs designated by the DOD installation to be furnished with a local microphone.

Note: The 120-dBA maximum is based on the assumption that the wide area MNS will expose personnel on the ground to a sound level of 120 dBA for no more than a total of 7.5 minutes out of any 24-hour period. This noise exposure limit should accommodate most anticipated daily messages and the occasional antiterrorism exercise without exceeding OSHA limits. DOD installations that anticipate that personnel will receive a longer time of noise exposure at this sound level must establish a lower maximum value (e.g., 90 dBA will permit up to an 8-hour noise exposure, 100 dBA for 2 hours' exposure, 110 dBA for 30 minutes' exposure) or provide hearing protection.

3-6.6 **Noise Pollution.** At some DOD installations, it is necessary to control the amount of sound that propagates in undesirable directions, such as into civilian communities adjacent to the DOD installation boundaries or into wildlife areas with protected or endangered animal species. Additionally, in some areas it might be necessary to mount wide area MNS speakers on the side of a building while simultaneously preventing an unacceptable increase in that building's interior noise levels.

3-6.6.1 **Design Goals.** Use speakers designed to minimize back-plane emissions for HPSA zones where the speakers will be mounted directly to an occupiable building, or where noise pollution is a concern for off-installation populated areas or sensitive wildlife areas.

3-6.6.2 **Speakers Attached to Buildings.** Speakers attached to occupiable buildings shall be capable of using phase shifting and filtering to help eliminate unwanted “spillover” emissions and back-plane noise.

3-6.6.3 **Measuring Noise in Buildings.** Back-plane noise transmitted inside of occupiable buildings shall be no more than 15 dBA above ambient noise.

3-6.7 **HPSA inside of Buildings.** HPSA zones shall not be used to provide mass notification inside any structures when UFC 4-010-01 would require an individual building MNS if the structure were built new or renovated.

3-6.8 **HPSA Speaker Sites.** Each HPSA site for each zone shall include a field-mounted local control unit, microprocessor, amplifier, standby batteries, charger, power supply, radio, mounting brackets and loudspeaker assembly for pole or building mounting. Those HPSA sites designated by the DOD installation shall be capable of microphone input and shall be provided with a microphone designed to prevent feedback at that particular microphone location.

3-6.8.1 **Locations of Sites.** Locations of the HPSA sites shall be verified and recorded with GPS coordinates. These locations shall be established prior to the installation of speaker array supporting structures as part of a site survey conducted jointly by the installing contractor and the DOD installation.

3-6.8.2 **Equipment Cabinets.** All equipment for each HPSA speaker site shall be housed in modular, mountable cabinets suitable for the local environmental conditions, including space heaters and ventilation fans, as appropriate.

Note: Enclosures qualified to the requirements of National Electrical Manufacturers Association (NEMA) 3R (rain tight), NEMA 4 (wash-down areas), or NEMA 4X (harsh environments) should be used for all outdoor applications.

3-6.8.3 **Surge Suppression.** All external conductors (conductors passing outside of the HPSA equipment cabinet) shall be provided with surge suppression tested to Underwriters Laboratories, Inc. (UL) standards as specified by UFC 3-520-01.

3-6.9 **HPSA Performance.** The HPSA control units shall provide at least these components and features:

3-6.9.1 A digitally addressable controller

3-6.9.2 The ability to receive and store messages via the primary (and redundant, if required) communication link with a confirmation signal sent back to the primary and redundant central control stations. Alternately, the DOD installation may authorize use of fixed, pre-recorded emergency messages that are physically installed in each HPSA (typically by installing an EPROM or flash memory device).

3-6.9.3 A charger/ power supply that will accept alternating current (AC) input,

backup electrical power generator input, battery input, or solar power cell input

3-6.9.4 The capability of storing at least 60 minutes of pre-recorded messages

3-6.9.5 The capability of providing a minimum of 7 standard tones. In addition, the systems shall have the capability to provide custom tones.

 Marine Corps systems require a minimum of 6 standard tones.

3-6.9.6 The ability to accept and play an auxiliary input from a digital recording device such as a compact disk (CD) player or Moving Picture Experts Group (MPEG) Layer 3 player

3-6.9.7 An amplifier efficiency of not less than 90 percent. The amplifier shall have not more than 0.1 percent total harmonic distortion (THD). The amplifier frequency response shall be at least 200 hertz (Hz) to 10,000 Hz. There shall be no more than 2 percent THD at the speaker at 1000 Hz.

Note: Some outdoor warning systems use amplifiers that are rated for as little as 30 minutes of continuous operation. These amplifiers are often of low efficiency and may be damaged by heat buildup. Such amplifiers may be adequate for many non-emergency applications; however, higher efficiency amplifiers with improved cooling capabilities should be used to provide the capability needed for antiterrorism operations.

3-6.9.8 The capability for local control at those HPSAs designated by the DOD installation. Designated HPSAs shall be able to function independently of the central control station. Designated HPSAs shall be furnished complete with a local microphone and local controls. The local microphone shall be designed to prevent feedback at that particular microphone location.

Note: Local control capability should be designated for all HPSAs where an on-scene commander is expected to be located during emergencies. This capability should also be designated for areas used for troop formations, parade fields, parks and sports fields, areas opened to the public for air shows or fireworks displays, and any other areas where an individual HPSA could be used by the DOD installation in lieu of providing a temporary public address (PA) system.

3-6.9.9 A headphone output port to permit private listening of the system broadcast at each HPSA designated by the DOD installation for testing purposes

 Not required for Marine Corps systems

3-6.9.10 An input port for connecting a laptop computer or digital device to make field changes. Alternately, the DOD installation may authorize use of fixed, pre-recorded emergency messages that are created elsewhere and physically installed in the HPSA (typically by installing an EPROM or flash memory device).

 Not required for Marine Corps systems

3-6.9.11 A tamper switch that will signal the central control station that the HPSA enclosure door is open

3-6.10 **Temperature Rating.** Speakers shall be able to operate between temperatures of -40 degrees Celsius (C) (-40 degrees Fahrenheit (F)) to +60 degrees C (+140 degrees F). Enclosures shall protect the HPSA control unit from external temperatures ranging from -40 degrees C (-40 degrees F) to +60 degrees C (+140 degrees F). The DOD installation should specify an upper external temperature limit of +80 degrees C (+175 degrees F) in those geographic locations subject to extreme heat.

3-6.11 **Battery Backup Power.** Each HPSA site shall be equipped with backup batteries to supply power for a minimum of 72 hours of electrical supervision following the loss of normal charging power, followed by a total of 60 minutes of full load operation at the end of the supervisory period.

Note: The DOD installation should specify the temperature to be used to size the backup batteries for the HPSA. Weather data for the DOD is maintained by the Air Force Combat Climatology Center and may be accessed for all DOD locations at <https://www2.afccc.af.mil/>. This site contains a database of engineering weather data that may be searched by installation or city name. Use of the lowest mean minimum temperature from the “Annual Summary of Temperatures” graph is recommended. Alternately, use the minimum design temperature of the HPSA control unit enclosure if internal heating is provided within the enclosure.

3-6.12 **Connection to Portable Electrical Power Generator.** Each HPSA site so designated by the DOD installation shall be capable of direct connection to a commercially available portable electrical power generator or a military-approved mobile electrical power (MEP) generator.

3-6.13 **Elevated Supporting Structure**

3-6.13.1 **Required.** An elevated supporting structure (e.g., pole, tower) shall be provided at each HPSA site other than those attached directly to a building.

3-6.13.2 **Structural Loads, Wind and Seismic Design.** The supporting structure shall be designed for the structural loads listed in UFC 3-310-01, except that the design wind speed shall be not less than 100 miles per hour (mph) (161 kilometers per hour (km/h), 86.8 knots). The supporting structure shall be sized to accommodate the static and dynamic loads produced by the sound systems and all attachments.

3-6.13.3 **Mounting Height.** The HPSA shall be attached to the elevated supporting structure. The minimum mounting height of the speakers shall be based on the rated output of the speakers and shall prevent hearing damage to

anyone directly below the speakers. Do not exceed noise exposure limits as specified in paragraph 3-6.5. The height shall not be less than 9 m (30 ft) or greater than 18 m (60 ft) above ground level. Ensure that the location and height of HPSA supporting structures do not interfere with aircraft flight operations.

3-6.13.4 **Mounting of Cabinets.** HPSA equipment cabinets shall be mounted on the elevated supporting structure with the top of the enclosure no more than 3 m (10 ft) above ground level. The equipment cabinet and power boxes must be capable of being locked shut.

3-6.14 **HPSA attached to Buildings**

3-6.14.1 **Mounting Height.** The HPSA shall be mounted at a minimum mounting height that is based on the rated output of the HPSA and shall prevent hearing damage to anyone directly below the speakers. Do not exceed noise exposure limits as specified in paragraph 3-6.5.

3-6.14.2 **Structural Loads, Wind and Seismic Design.** The mounting of the HPSA shall be designed for the structural loads listed in UFC 3-310-01, except that the design wind speed shall be not less than 100 mph (161 km/h, 86.8 knots). The mounting shall be sized to accommodate the static and dynamic loads produced by the sound systems and all attachments.

3-6.14.3 **Sound into Building.** If attached to an occupiable building, the HPSA shall not permit unacceptable levels of sound into the building. (See paragraph 3-6.6.3.)

3-6.14.4 **Noise Exposure under HPSA.** Do not exceed the OSHA occupational noise exposure limits specified in paragraph 3-6.5.

3-7 **COMMUNICATIONS LINKS**

3-7.1 **Primary Communications Link.** Primary communications shall use radio frequency-type systems that comply with National Telecommunications and Information Administration (NTIA) requirements. The systems shall be designed to minimize the potential for interference, jamming, eavesdropping, and spoofing.

Note: See Appendix C for a discussion of requirements for Internet-based communication systems (under development).

3-7.1.1 **Licensed Radio Frequency Systems.** An approved DD Form 1494 for the system is required prior to operation. When available, use systems designed for secure digital communication standards such as the Association of Public-Safety Communications Officials (APCO) Standard 25.

Note: APCO 25 is an industry-wide effort to set the recommended voluntary standards of uniform digital two-way radio technology for public safety organizations.

Note: Receiving a new radio frequency assignment often takes a relatively long time. Be sure to request the frequency assignment early in the design process.

3-7.1.2 Non-licensed Radio Frequency Systems. When authorized by the DOD installation commander, the NTIA permits the use in the continental United States (CONUS) of non-licensed radio frequency-type devices that conform to Federal Communications Commission (FCC) rules and regulations (47 CFR 15); however, all transmitting devices on a military installation require an approved DD Form 1494 prior to installation. In locations outside of the continental United States (OCONUS), confirm that the devices conform to host-country regulations and obtain the approval from the DOD installation commander prior to using non-licensed radio frequency-type devices. In all cases, request permission from the spectrum manager for the local area. Provide GPS coordinates of installed transmitters when required by the spectrum manager.

Note: Non-licensed devices operate at very low power levels, have no vested or recognized right to any part of the radio frequency spectrum, and are not required to provide any immunity to interference. If a non-licensed system is selected, be sure the system compensates for these limitations by providing suitable radio signal modulation features (e.g., spread spectrum and frequency hopping) and that propagation distance parameters for the radio signals are not exceeded.

3-7.2 Redundant Communications Link. Redundant communication means (when required) should be established using several alternate wireless radio frequency paths to the radios. In some cases, the redundant communication means might be accomplished by using the DOD installation's communications backbone network (e.g., optical fiber cable). In this case, the central control units should accomplish this by being directly connected to the backbone network.

Note: All software and hardware to be installed on DOD Ethernet or Internet systems must first successfully complete an accreditation process. Accreditation often takes a relatively long time.

Note: See Appendix C for a discussion of requirements for Internet-based communication systems (under development).

3-7.3 Off-the-Shelf Equipment. Communications equipment furnished as part of the wide area MNS shall be commercial off-the-shelf (COTS). All programming codes or passwords required to access, update, modify, and maintain the communications equipment shall be provided to the DOD installation no later than the date of final system acceptance.

Note: Receiving authorization to operate any communications equipment often takes a relatively long time. Be sure to request approval early in the design process. At some DOD installations, a certificate to operate (CTO) or certificate of worthiness (CON) is required.

3-7.4 **Supervision.** Full system supervision shall be provided. Notification of system alarm, supervisory, and trouble signals shall be provided to the central control stations within a time period not to exceed 200 seconds.

3-7.5 **Diagnostics.** The communications systems shall provide self-test and diagnostics capabilities. Local diagnostics information shall be transmitted to the central control stations.

3-7.6 **Interfaces with Other Systems.** The communications systems shall be capable of interfacing with existing fire alarm systems, existing PA systems, and existing telephone dialing systems on the DOD installation. The communications systems shall be designed with an established protocol that is provided to the DOD installation to allow existing and future individual building MNS from other manufacturers to interface with the wide area MNS. The wide area MNS manufacturer shall provide a standard interface method (such as an audio line-level output and multiple relay contacts) or supply the necessary digital communication protocols to permit the DOD installation to select more than one manufacturer of individual building MNS.

 Marine Corps systems will interface with the telephone dialer system that has been approved by the AHJ. (See paragraph 1-3.4 for more information on the AHJ).

CHAPTER 4

INDIVIDUAL BUILDING MNS FOR NEW CONSTRUCTION PROJECTS

4-1 **SCOPE.** Individual building MNS are intended to provide real-time information to personnel within and in the immediate vicinity of buildings on a DOD installation. These systems are required by UFC 4-010-01 for new construction and renovation of existing buildings. This chapter provides the design criteria for new construction projects. It discusses the requirements of the individual building MNS that is installed in new construction as part of a combined MNS/fire alarm system.

Note: In most cases, the simplest and most economical approach for new construction will be to install a combined system that performs both as an individual building MNS and as the building fire alarm/voice evacuation system.

4-2 **REQUIREMENTS FOR SYSTEM DESIGNERS.** The individual building MNS shall be designed under the supervision of a registered fire protection engineer, by a registered professional engineer having at least four years of current experience in the design of fire protection and detection systems, or by an engineering technologist qualified at NICET Level IV in fire alarm systems. The individual's name, signature, and professional engineer number or NICET certification number shall be included on all final design documents.

SE Navy systems shall be designed only by a registered fire protection engineer who has passed the fire protection engineering written examination administered by the National Council of Examiners for Engineering and Surveys (NCEES).

4-3 **SYSTEM OVERVIEW.** A combined system is required by the Navy and is highly recommended by the Army and Air Force. The combined system design may be used by the Marine Corps when specifically approved by the AHJ based on the class and size of the building requiring the MNS. Otherwise, Marine Corps projects will use the technical criteria of Chapter 5. If an Army or Air Force installation approves use of a separate MNS and separate building fire alarm system in a new construction project, use the technical criteria of Chapter 5.

SE A separate MNS may be installed in Navy projects for a building not provided with a fire alarm system. See Chapter 5.

Note: See paragraph 6-5 for MNS requirements for special occupancies such as medical facilities and facilities intended for occupancy by persons not capable of self-preservation.

4-3.1 **Subsystems.** An individual building MNS for new construction projects includes several subsystems: autonomous control unit (ACU); local operating consoles (LOC); notification appliance network; and interface with the wide area MNS on the DOD installation. System design and wiring is designed to meet

NFPA 72 requirements for MNS and fire alarm systems.

4-3.2 ACU

4-3.2.1 **Functions.** The ACU is used to monitor and control the notification appliance network. At the ACU, personnel in the building can initiate delivery of pre-recorded voice messages, provide live voice messages and instructions, and initiate visual strobe and alphanumeric message notification appliances. Actions taken at the ACU take precedence over actions taken at any other location, including the LOC, or inputs from the wide area MNS on the DOD installation.

4-3.2.2 **Combined System.** For new construction, the ACU shall be integrated with the building fire alarm control panel (FACP) to form one combined system that performs both functions. The building PA system for smaller buildings may be integrated with the combined system so that all three functions—mass notification, fire alarm, and PA—are provided by one building system. In large buildings, however, combining the PA system will typically require the design of very complex speaker switching matrices and is not recommended. Combined systems shall meet the requirements of NFPA 72.

Note: A combined system may include an ACU and FACP supplied from different manufacturers or placed in separate equipment enclosures; however, the ACU and FACP must be integrated in their controls and performance to meet the requirements of NFPA 72 and this UFC.

Note: The Army and Air Force permit the MNS and fire alarm system to be installed as separate systems if mandated by the DOD installation. The Marine Corps normally requires the MNS and fire alarm system to be installed as separate systems unless specifically permitted by the AHJ. See Chapter 5 for technical criteria for this design approach.

4-3.3 **LOC.** A LOC is a unit designed to allow emergency response forces and building occupants to operate the individual building MNS, including initiating delivery of pre-recorded voice messages, providing live voice messages and instructions, initiating visual strobe and alphanumeric message notification appliances, overriding external voice announcements, and terminating mass notification functions. A LOC is usually contained in a small, wall-mounted enclosure. Not all functions that could be performed at the ACU are necessarily available at a LOC.

4-3.4 **Notification Appliance Network.** A notification appliance network consists of a set of audio speakers, strobes, and text signs (when required) that are located to alert occupants and provide intelligible voice and visual instructions.

4-3.4.1 **Audio Appliance Network.** Speakers are provided at all locations in the building and also around the building at entrances/exits and other outdoor areas (such as courtyards) commonly used by the building occupants. Important

design considerations for the audio speakers include intelligibility and audio intensity.

Note: Outside notification more than 5 m (16 ft) from the building should be provided by the wide area MNS.

4-3.4.1.1 Intelligibility is defined in NFPA 72. Commercially available test instrumentation shall be used to verify intelligibility.

4-3.4.1.2 Effective voice communication within buildings occurs by using a system design of many speakers, each with low audio intensity.

4-3.4.2 **Visual Appliance Network.** Strobes are provided at all locations inside the building to meet the accessibility requirements of UFAS for persons with hearing disabilities. Strobes are provided at the same locations in a building that would be required for a fire alarm system notification appliance. Combined MNS/FACP systems may use either one strobe (clear) or two strobes (clear for fire and amber for MNS) as specified by the AHJ.

4-3.4.2.1 Navy installations shall use one clear strobe and also shall provide text signs. Text signs are required over the door to each egress stairwell and over (or adjacent to) the substantial means of egress from the level of discharge. Exterior exit doors from a single room (e.g., mechanical or electrical rooms) do not require a text sign.

4-3.4.2.2 Army and Air Force installations shall use a clear strobe for fire and an amber strobe for MNS. Use of text signs is optional and at the discretion of the DOD installation. If provided, text signs shall be located over the door to each egress stairwell and over (or adjacent to) the substantial means of egress from the level of discharge. Exterior exit doors from a single room (e.g., mechanical or electrical rooms) do not require a text sign.

4-3.4.2.3 Marine Corps installations shall contact the AHJ for guidance on visual notification appliances.

4-3.5 **Interfaces with the Wide Area MNS.** If a wide area MNS is provided on the DOD installation, the individual building MNS communicates with the central control units of the wide area MNS to provide status information, receive commands, activate pre-recorded messages, and originate live voice messages. If no wide area MNS is provided on the DOD installation, at a minimum, the individual building MNS shall be able to receive an audio line-level input.

4-3.6 **Logical Block Diagrams.** Figures 4-1 and 4-2 show the logical block diagrams for acceptable configurations of the individual building MNS for new construction.

Note: These diagrams are intended to show only the functional relationships of the major components. They are not intended to serve as wiring diagrams. Many

essential design features for an operational system, such as end-of-line resistors, are not shown.

**Figure 4-1. Individual Building Mass Notification System:
Combination Fire Alarm System and MNS (Navy)**

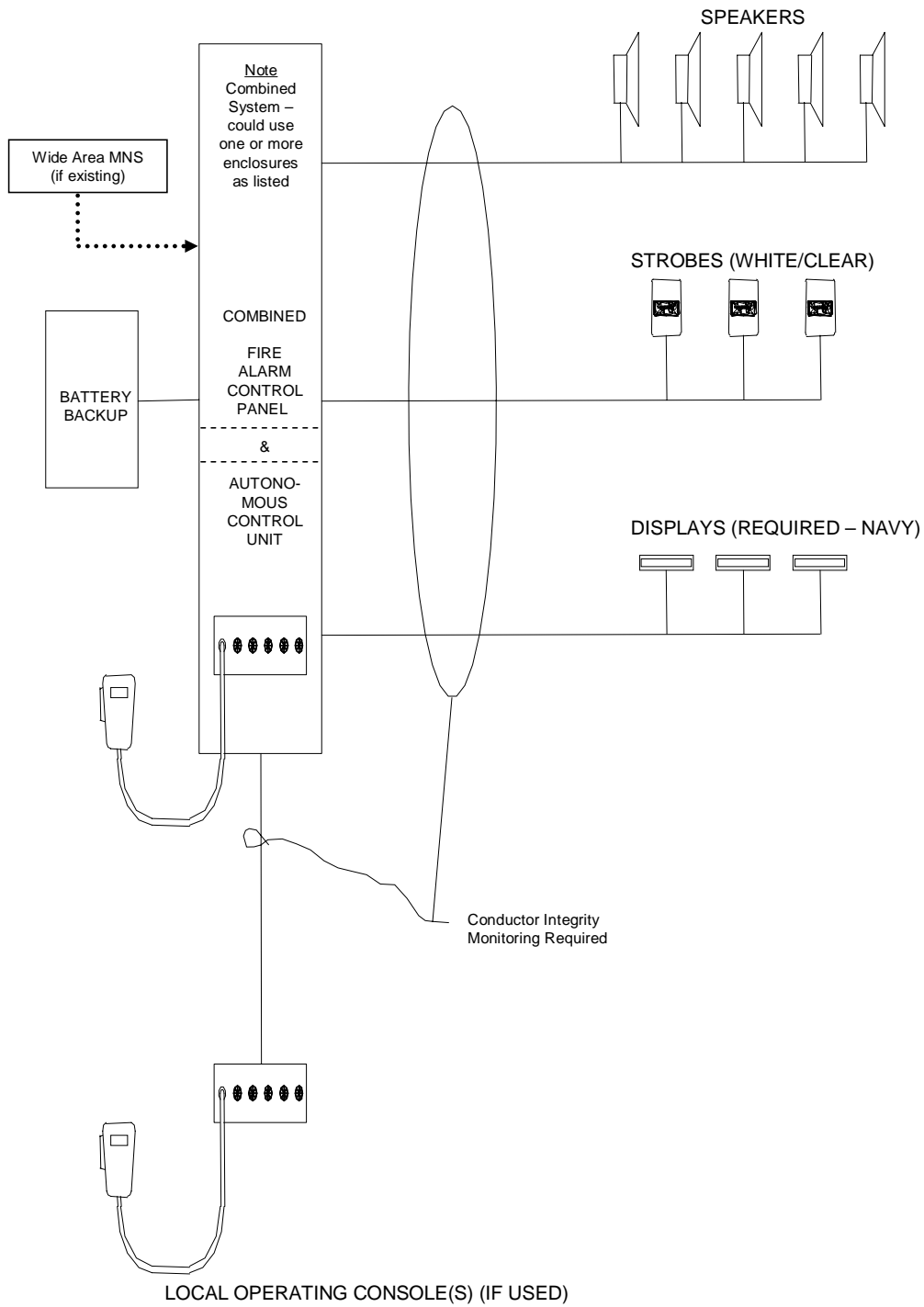

**Figure 4-2. Individual Building Mass Notification System:
Combination Fire Alarm System and MNS (Army and Air Force)**

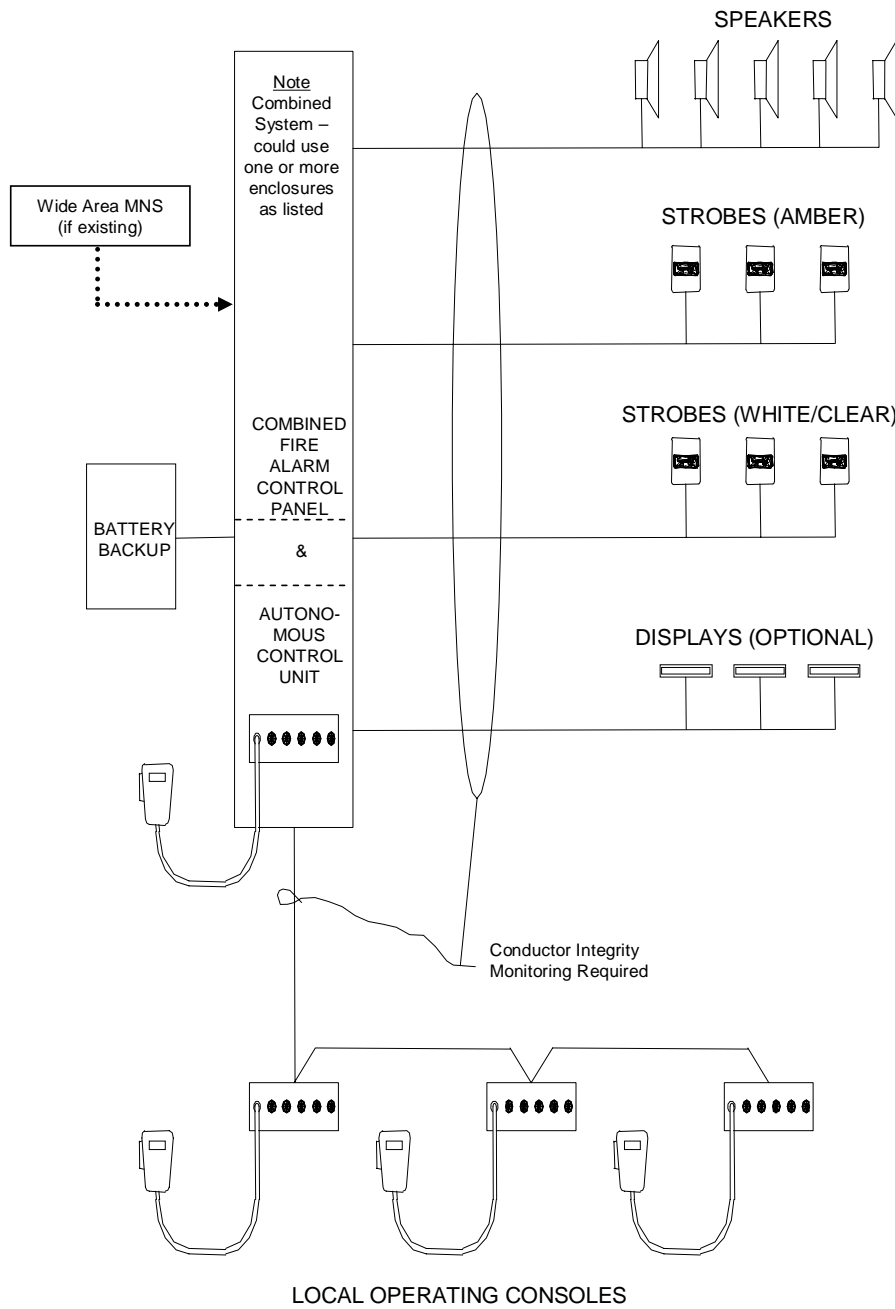

4-4 ACU

4-4.1 **Locations.** The ACU shall form a combined system with the FACP. These control panels may be co-located in the same enclosure or may be physically separated. If they are located in the same enclosure, install the enclosure at the location normally specified by the DOD component AHJ for a stand-alone FACP.

4-4.2 **Design Features.** The ACU shall:

- Be able to function independently upon failure of the wide area MNS (if provided on the DOD installation).
- Be a listed combination system with the fire alarm system as described in NFPA 72 and meeting UL Standard 864 and the specific requirements of this UFC. The listing evaluation shall be accomplished by UL, Factory Mutual Research Corporation (FM), or another nationally recognized testing laboratory (NRTL).

Note: Systems designed to UL 2017 instead of UL 864 may not be used for a combination system. Systems designed to UL 2017 are permitted for a MNS separate from the fire alarm system (see Chapter 5).

- Be able to activate strobes and text signs:
 - Navy: Energize clear strobe lights marked “ALERT” along with light-emitting diode (LED)-type text signs. Text signs are required over the door to each egress stairwell and over (or adjacent to) the substantial means of egress from the level of discharge. Exterior exit doors from a single room (e.g., mechanical or electrical rooms) do not require a text sign. Strobes shall meet all UL listing requirements for fire alarm system strobes except for the marking “ALERT.”
 - Marine Corps: Contact the AHJ for guidance on visual notification appliances.
 - Army and Air Force: Energize either one set of clear strobe lights marked “FIRE” for the fire alarm system or a separate set of amber strobe lights marked “ALERT” for the MNS as appropriate for the emergency. Energize LED-type text signs if required by the DOD installation.
- Make general paging or other non-emergency messages available without the activation of strobes. A separate microphone must be provided for this purpose.

- Have the ability to interrupt PA system announcements and to silence building background music while delivering voice messages.
- Be able to accept voice messages from the DOD installation telephone system
- Have conductor connections that comply with NFPA 72.

Note: Ethernet or IP connections for initiating and indicating circuits are not currently available that will meet NFPA 72 requirements and, therefore, may not be used. Additionally, all software and hardware to be installed on DOD Ethernet or Internet systems must first successfully complete an accreditation process. Accreditation often takes a relatively long time.

- Have conductor integrity monitoring for strobes, speaker wiring, power supplies, and connections to the LOC.
- Be able to switch between MNS and fire alarm notification functions without generating trouble alarms in either system.
- Have the capacity for multiple pre-recorded messages (at least eight, but more if required by the DOD installation). Pre-recorded messages shall be passed in the English language and, for OCONUS locations, also in the predominant language(s) used by the host nation. Pre-recorded messages, if used, should address at least these subjects:
 - Bomb threat or actual bomb within/around the building
 - Intruder/hostile person sighted within/around the building
 - Directions to occupants to take cover within the building
 - Evacuation of the building using exits other than the normal main entrance/exit (since the front entrance/exit is often a location targeted by terrorists)
 - Emergency weather conditions appropriate for the local area
 - “All Clear” message
 - A test message intended for verifying functionality of the system.

 The Marine Corps AHJ will determine the number and content of pre-recorded messages.

- Be able to deliver messages quickly.

- Be able to automatically repeat pre-recorded messages until they are terminated.
 - Have a microphone for delivering live voice messages.
 - Have adequate discrete outputs to initiate text signs and initiate strobes.
 - Interface to the LOC for initiating recorded messages and delivering live voice messages from locations in the building other than at the ACU.
 - Establish priority for passing messages to prevent interference between the ACU, LOC, and the wide area MNS on the DOD installation.
 - Allow the MNS to temporarily override fire alarm audible messages and visual signals, and to provide intelligible voice commands during simultaneous fire and terrorist events. All other features of the fire alarm system, including the transmission of signals to the fire department, shall function properly. MNS messages shall take priority and continue to override fire alarm audible messages until the MNS message is either manually or automatically ended. If not manually ended, the MNS message will automatically end after 10 minutes.
 - Provide a supervisory signal if the MNS is used to override fire alarm audible messages and visible signals during simultaneous fire and terrorist events. The supervisory signal shall be annunciated at the FACP and any remote fire alarm annunciators and be transmitted to the fire department. The visual annunciation of the separate supervisory signal shall be distinctly labeled or otherwise clearly identified.
-  The Army requires that this supervisory signal be separate from other fire alarm system supervisory signals.
- Remote monitoring of trouble, supervisory, and alarm functions to a constantly occupied location meeting the requirements of NFPA 72
 - Have a single switch or operating mechanism capable of shutting down all heating, ventilating, and air conditioning (HVAC) equipment in the facility in accordance with the requirements of UFC 4-010-01. If permitted by the DOD installation, this shutdown capability may be provided at a LOC or be deleted entirely if the capability is otherwise provided at a location readily accessible to building occupants.
 - Provide a complete set of self-diagnostics for the controller and appliance network.

- Have a local diagnostic information display.
- Provide a local system event log file.

4-4.3 **Off-the-Shelf Equipment.** ACU equipment furnished as part of the individual building MNS shall be COTS and shall be tested to the standards of UL or FM by a NRTL.

4-4.4 **Programming Codes.** All programming codes or passwords required to access, update, modify, and maintain the ACU shall be provided to the DOD installation no later than the date of final system acceptance.

4-4.5 **Power Supply Features.** The power supply shall:

- Be capable of accepting 120/240 VAC, 50/60 Hz.
- Be appropriate for a MNS/FACP system that meets at least the minimum NFPA 72 requirements for standby power capacity. In addition, secondary (standby) power should be provided as follows: immediately upon loss of normal AC power, the standby source of power shall provide a minimum of 60 minutes of mass notification at the maximum connected load.
- Disable use of any microphones intended solely for general paging or other non-emergency messages upon loss of normal AC power.
- Conform to applicable sections of NFPA 72.
- Use only COTS components.
- Provide surge protection in accordance with UFC 3-520-01.

4-5 **LOC**

4-5.1 **Locations.** Provide a LOC to allow emergency response forces and building occupants to access the MNS and originate messages in emergency situations from locations in the building other than from the ACU. Follow these requirements:

- Provide a separate LOC for use by the fire department near the building FACP (or fire command center) unless this is also the location of the ACU.
- Do not place a LOC inside a locked room or closet (with the possible exception of the LOC intended for use by the fire department near the FACP).

- Install a LOC at those facility entrances/exits that will be used when building access is limited because of elevated terrorism threat levels.

Note: This LOC is intended to enable immediate notification of building occupants when unauthorized building access is threatened or has occurred at this location.

- Army and Air Force: Provide a LOC so that occupants do not need to travel more than 61 m (200 ft) horizontally or to travel to other floors to access a LOC.
- Army and Air Force: Make a LOC available for use by visitors in those facilities open to unescorted visitors or to the public.
- Navy: Provide no more than one LOC (if necessary) in addition to the ACU. Locate the LOC as directed by the responsible fire protection engineer.
- Marine Corps: Provide no more than one LOC (if necessary) in addition to the ACU. Locate the LOC as directed by the AHJ.

4-5.2 **Design Features.** The LOC shall:

- Have a remote microphone station that emulates operation of the MNS from the ACU.
- Have an easy method (such as individual manual activation push buttons) of activating the MNS pre-recorded messages. Signage shall be provided to allow rapid recognition of the means of initiating the pre-recorded messages.

 Activation of MNS pre-recorded messages is not required for Marine Corps LOC.

- Provide a single switch or operating mechanism capable of shutting down all HVAC equipment in the facility in accordance with the requirements of UFC 4-010-01. If permitted by the DOD installation, this shutdown capability may be provided at only one LOC when multiple LOCs are installed, or be deleted from all LOCs if the capability is otherwise provided at a location readily accessible to building occupants.
- Be protected in a small, wall-mounted enclosure.
- Have supplemental heating and ventilation for those enclosures located outdoors or in areas where the LOC will be exposed to temperatures or humidity outside of the manufacturer's design limits.

- Be protected from tampering by use of a break-glass, thumb-lock, tamper wire, tamper alarm, or equivalent protection. This is not required in those facilities with limited access so that unauthorized use would not reasonably be expected to occur. Enclosures that can be opened only by a key shall not be used.

SE Marine Corps LOC may use key-operated locks when emergency response forces are provided with immediate access (e.g., master key, Knox-box®)

- Have signage on the outside of the enclosure similar to “Mass Notification” and “HVAC Emergency Shutdown” (if applicable).

4-6 NOTIFICATION APPLIANCE NETWORK

Note: Also see paragraph 6-5 for notification appliance requirements in special occupancies.

4-6.1 **Audible Appliance Network.** These are the requirements of the audible appliance network:

- Provide appliances capable of satisfying all UFAS and Americans with Disabilities Act Accessibility Guidelines (ADAAG).
- Use speakers suitable for the intended climatic and environmental conditions.
- Use speakers suitable for installation in commercial/industrial applications with consideration of electrically hazardous (classified) locations.
- Provide speakers and installation methods compliant with Director of Central Intelligence Directive (DCID) 6/9 for areas classified as sensitive, compartmented information facilities (SCIF).
- Speakers shall meet the listing requirements of UL Standard 1480.
- System design shall comply with NFPA 72.
- Provide speakers at all locations inside a building where the building fire alarm must be audible.
- Provide speakers mounted on the exterior of the building to provide notification of any areas commonly used by building occupants. These include courtyards, covered break areas, designated smoking areas, and sidewalks leading from the building’s exit doors to a public street or from parking areas for a distance up to 5 m (16 ft) from the building. Use speakers with directional characteristics that transmit minimal

backplane noise when mounted on the sides of the building. Generally, the speakers should be located near entrance/exit doors.

- Provide an effective voice communication within buildings using a design including many speakers, each with low audio intensity.
- Install speakers with field-adjustable tap settings to allow adjustment after installation to meet audibility and intelligibility requirements.
- Do not use speakers exceeding 15 watts (W) for indoor applications without prior approval of the AHJ.
- Wiring methods shall comply with NFPA 72. Class B wiring is permitted unless Class A wiring is required for fire alarms systems on the DOD installation.

4-6.1.1 **Speaker Design Recommendations**

- Speakers rated at 2 W or less and with multiple tap settings to adjust the output power can often provide acceptable sound quality in most occupied areas.
- Speakers rated at 8 W or less and with multiple tap settings can often provide acceptable sound quality for most large or very noisy areas.
- Speakers rated at 8 to 10 W for interior distribution should be used when the speakers are also intended to meet the better sound quality normally expected from PA systems. These speakers should be capable of a frequency response over the range at least 200 Hz to 10,000 Hz.

Note: Such speakers are often adjusted to operate at a tap setting of 2 W or less, but are used because their sound quality is greatly superior to the small speakers typically used in fire alarm systems.

4-6.1.2 **Navy- and Marine Corps-Specific Requirements**

- Verify intelligibility by measurement after installation.
- Ensure that a CIS score greater than 0.7 is provided in each area where building occupants normally could be found.
- Areas of the building provided with hard wall and ceiling surfaces (such as metal or concrete) that are found to cause excessive sound reflections may be permitted to have a CIS score less than 0.7 if approved by the DOD installation, and if building occupants in these areas can determine that a voice signal is being broadcast and they must walk no more than 10 m (33 ft) to find a location with at least a 0.7 CIS.

- Areas of the building where occupants are not expected to be normally present are permitted to have a CIS score less than 0.7 if personnel can determine that a voice signal is being broadcast and they must walk no more than 15 m (50 ft) to a location with at least a 0.7 CIS.
- Measurements should be taken near the head level applicable for most personnel in the space under normal conditions (e.g., standing, sitting, sleeping, as appropriate).
- Commercially available test instrumentation shall be used to measure intelligibility as specified by IEC 60849 and IEC 60268-16. The mean value of at least three readings shall be used to compute the intelligibility score at each test location.

Note: An STI score of 0.5 is considered equivalent to a CIS score of 0.7.

4-6.1.3 **Army- and Air Force-Specific Requirements**

- Verify intelligibility by measurement after installation.
- Ensure that a CIS score greater than 0.8 is provided in each area where building occupants normally could be found. Note: Values of 0.75 through 0.84 will be rounded to 0.8.
- Areas of the building provided with hard wall and ceiling surfaces (such as metal or concrete) that are found to cause excessive sound reflections may be permitted to have a CIS score less than 0.8 if approved by the DOD installation, and if building occupants in these areas can determine that a voice signal is being broadcast and they must walk no more than 10 m (33 ft) to find a location with a CIS score of at least 0.8.
- Areas of the building where occupants are not expected to be normally present are permitted to have a CIS score less than 0.8 if personnel can determine that a voice signal is being broadcast and they must walk no more than 15 m (50 ft) to a location with a CIS score of at least 0.8.
- Measurements should be taken near the head level applicable for most personnel in the space under normal conditions (e.g., standing, sitting, sleeping, as appropriate).
- Commercially available test instrumentation shall be used to measure intelligibility as specified by IEC 60849 and IEC 60268-16. The mean value of at least three readings shall be used to compute the intelligibility score at each test location.

Note: An STI score of 0.7 is considered equivalent to a CIS score of 0.8.

4-6.2 **Visual Appliance Network.** These are the requirements for the visual appliance network:

- Provide visual appliances capable of satisfying all UFAS and ADAAG.
- Use visual appliances suitable for the intended climatic and environmental conditions.
- Use visual appliances suitable for installation in commercial/industrial applications with consideration of electrically hazardous (classified) locations.
- Strobes shall meet the listing requirements of UL Standards 1638 and 1971. Text signs shall comply with UL Standard 48.
- Strobes are not required outside the building.
- Where more than two visible notification appliances are in any field of view, they shall flash in synchronization.
- Wiring methods shall comply with NFPA 72. Class B wiring is permitted unless required otherwise by the local AHJ.

4-6.2.1 **Navy-Specific Requirements**

- Provide clear strobes marked with the word “ALERT” for shared use by the building’s combination MNS/FACP.
- Provide LED text signs. Text signs are required over the door to each egress stairwell and over (or adjacent to) the substantial means of egress from the level of discharge. Exterior exit doors from a single room (e.g., mechanical or electrical rooms) do not require a text sign. (See Chapter 7 for operational requirements and information on message content.)

4-6.2.2 **Marine Corps-Specific Requirements**

- Contact the AHJ for guidance on visual notification appliances.

4-6.2.3 **Army- and Air Force-Specific Requirements**

- Provide amber-colored strobes marked with the word “ALERT” to alert the hearing impaired. Provide these strobes in addition to existing clear strobes provided for the building fire alarm system.
- Amber strobes activated in conjunction with the delivery of a pre-recorded voice message shall operate continuously until message termination. Amber strobes activated in conjunction with the delivery of

a live voice message shall operate during the message and for not less than 15 seconds after the message ends.

- Clear/white strobes activated by the fire alarm system shall not operate during those periods when the amber strobes are in operation, but otherwise shall operate continuously until the fire alarm system is reset.

4-7 **INTERFACES WITH WIDE AREA MNS.** The individual building MNS shall be capable of being interoperable with an existing wide area MNS. If a wide area MNS is not presently provided on the DOD installation, the individual building MNS shall be designed to allow future interface with a wide area MNS procured from another manufacturer. The electrical requirements, computer codes, or other protocols that are needed to interface the systems shall be provided to the DOD installation.

Note: When a wide area MNS is provided on the DOD installation, the system manufacturer should provide a standard method (such as an audio line-level output and multiple relay contacts) or supply the necessary digital communication protocols to permit the DOD installation to select more than one manufacturer of individual building MNS. Depending on system architecture, the manufacturer may be required to provide a system IP interface capable of allowing data transfer from an outside source to internal mass notification functions via a common data communications protocol.

CHAPTER 5

INDIVIDUAL BUILDING MNS FOR RENOVATION PROJECTS

5-1 **SCOPE.** Individual building MNS are intended to provide real-time information to personnel within and in the immediate vicinity of buildings on a DOD installation. These systems are required by UFC 4-010-01 for new construction and renovation of existing building. This chapter provides the design criteria for renovation projects, including the installation of MNS in existing buildings. This chapter should be used for new Marine Corps projects unless combination systems (see Chapter 4) are specifically approved by the AHJ. This chapter should also be used when an Army or Air Force installation approves the use of a separate MNS and separate building fire alarm system in a new construction project.

Note: See paragraph 6-5 for MNS requirements for special occupancies such as medical facilities and facilities intended for occupancy by persons not capable of self-preservation.

5-2 **REQUIREMENTS FOR SYSTEM DESIGNERS.** The individual building MNS shall be designed under the supervision of a registered professional engineer with a minimum of four years of current work experience in fire protection, electrical, and communication-electronics engineering areas specific to individual building MNS. Alternately, the individual building MNS may be designed by an engineering technologist verified by NICET as certified at Level IV in low voltage electronic-communications systems or at Level IV in fire alarm systems, plus this engineering technologist shall possess a minimum of four years current work experience specific to individual building MNS communications-electronics. Alternately, the individual building MNS may be designed by an engineering technologist that possesses a minimum of ten years of documented current work experience specific to individual building MNS communications-electronics. The individual's name, signature, and professional engineer number or NICET certification number (when applicable) shall be included on all final design documents.

5-3 USE OF NEW CONSTRUCTION CRITERIA

5-3.1 **FACP Replacement: No Existing MNS in Building.** When replacing a FACP in a building without an existing MNS, provide a combination mass notification and fire alarm system meeting the requirements for new construction projects (see Chapter 4).

5-3.2 **FACP Replacement: Existing MNS in Building.** When replacing a FACP in a building with an existing separate MNS, removal of both systems and installation of a combination system meeting new construction criteria is recommended but not required. Consider the age and condition of the MNS and the life-cycle costs of keeping the existing MNS when determining whether to

install a new combined system or remain with separate systems.

5-3.3 MNS Installation Projects. When installing a MNS in a building with an existing separate FACP, removal of both systems and installation of a combination system meeting new construction criteria is recommended but not required. Consider the age and condition of the FACP and the life-cycle costs of keeping the existing FACP when determining whether to install a new combined system or remain with separate systems.

SE Separate systems are required for Marine Corps projects unless a combination system is specifically permitted by the AHJ.

5-4 SYSTEM OVERVIEW

5-4.1 Subsystems. An individual building MNS for renovation projects includes several subsystems: ACU; LOC; notification appliance network; interface with facility FACP; interface with facility PA system; and interface with the wide area MNS on the DOD installation. System design and wiring must meet NFPA 72 requirements for MNS and fire alarm systems.

SE Individual building MNS for Marine Corps projects shall serve as a subsystem of the wide area MNS.

5-4.2 ACU. The ACU is used to monitor and control the notification appliance network. At the ACU, personnel in the building can initiate delivery of pre-recorded voice messages, provide live voice messages and instructions, initiate visual strobe and alphanumeric message notification appliances, and temporarily silence fire alarm system visual and audible notification appliances.

SE Marine Corps MNS designs are not required to use an ACU.

5-4.3 LOC. A LOC is a unit designed to allow emergency response forces and building occupants to operate the individual building MNS, including initiating delivery of pre-recorded voice messages, providing live voice messages and instructions, initiating visual strobe and alphanumeric message notification appliances, temporarily silencing fire alarm system visual and audible notification appliances, overriding external voice announcements, and terminating mass notification functions. A LOC is usually contained in a small, wall-mounted enclosure. Not all functions that could be performed at the ACU are necessarily available at a LOC.

SE Marine Corps MNS designs are not required to use a LOC.

5-4.4 Notification Appliance Network. A notification appliance network consists of a set of audio speakers, strobes, and text signs (when required by the AHJ) located to alert occupants and provide intelligible voice and written instructions. When required, text signs are installed over the door to each egress

stairwell and over (or adjacent to) the substantial means of egress from the level of discharge. Exterior exit doors from a single room (e.g., mechanical or electrical rooms) do not require a text sign.

 Text signs are not authorized in Marine Corps MNS designs unless specifically permitted by the AHJ.

5-4.4.1 Audio Appliance Network. Speakers are provided at all locations in the building and are provided around the building at entrances/exits and other outdoor areas (such as courtyards) commonly used by the building occupants. Important design considerations for the audio speakers include intelligibility and audio intensity.

Note: Outside notification more than 5 m (16 ft) from the building should be provided by the wide area MNS.

5-4.4.1.1 Intelligibility is defined in NFPA 72. Commercially available test instrumentation shall be used to verify intelligibility.

5-4.4.1.2 Effective voice communication within buildings occurs by using a system design of many speakers, each with low audio intensity.

5-4.4.2 Visual Appliance Network. Strobes are provided at all locations inside the building to meet UFAS accessibility requirements for persons with hearing disabilities. Strobes are provided at the same locations in a building that would be required for a fire alarm system notification appliance. Separate MNS and FACP systems may use either one strobe (clear) or two strobes (clear for fire and amber for MNS) as specified by the AHJ. Text signs may be required by the AHJ over the door to each egress stairwell and over (or adjacent to) the substantial means of egress from the level of discharge. Exterior exit doors from a single room (e.g., mechanical or electrical rooms) do not require a text sign.

5-4.4.2.1 Army and Air Force installations shall use existing clear/white strobes for fire and install amber strobes for MNS. New amber strobes will be marked with word "ALERT." Installation of text signs is optional and at the discretion of the DOD installation.

5-4.4.2.2 Marine Corps installations shall contact the AHJ for guidance on visual notification appliances.

5-4.5 Interfaces with Facility FACP. The MNS shall provide the capability (either internally as a design feature, or with an approved or listed external controller) to temporarily deactivate the facility's fire alarm system audible and visual notification appliances. This is intended to allow the MNS to provide intelligible voice commands inside an individual building during simultaneous fire and terrorist events. System features are provided to compensate for the increased risk from fire in these cases.

SE Marine Corps MNS designs may interface with the facility FACP. Contact the AHJ for guidance.

5-4.6 **Interfaces with Facility PA System.** The use of the speakers and other components in the existing PA system may be appropriate in smaller size buildings in which the installation of a new speaker system is not cost effective and the existing PA system is new or relatively new, in excellent condition, and of relatively simple design. If this implementation approach is taken, an ACU must be interfaced with the existing PA system. The existing PA system must be tested to demonstrate acceptable intelligibility of the voice messages, and additional speakers must be added as required. These features must be provided in or added to the PA system:

- Emergency messages must have priority over non-emergency messages.
- All individual or zone speaker volume controls must default to the emergency sound level when used for an MNS message.
- Provide a supervisory signal when the PA system has been placed in the “OFF” condition.
- When monitoring of circuit integrity is provided by the PA system, continue monitoring even if local speaker volume controls are placed in the “OFF” position.
- Provide the required visual notification appliance network (i.e., strobes and text signs).

SE Marine Corps MNS designs are not required to provide an interface with the facility PA system.

Note: The term “public address system” (or “PA system”) is used in this UFC to mean both PA and intercommunication systems.

5-4.7 **Interfaces with the Wide Area MNS.** If a wide area MNS is provided on the DOD installation, the individual building MNS communicates with the central control units of the wide area MNS to provide status information, receive commands, activate pre-recorded messages, and originate live voice messages. Depending on system architecture, the manufacturer may be required to provide a system IP interface capable of allowing data transfer from an outside source to internal mass notification functions via a common data communications protocol.

SE Marine Corps MNS designs shall interconnect the wide area MNS with the individual building MNS through the use of common control systems.

Note: When a wide area MNS is provided on the DOD installation, the system

manufacturer should provide a standard method (such as an audio line-level output and multiple relay contacts) or supply the necessary digital communication protocols to permit the DOD installation to select more than one manufacturer of individual building MNS.

5-4.8 **Logical Block Diagrams.** Figures 5-1 through 5-7 show the logical block diagrams for acceptable configurations of the individual building MNS for renovation projects, including the installation of MNS in existing buildings.

Note: These diagrams are intended to show only the functional relationships of major components. The diagrams are not intended to serve as wiring diagrams. Many essential design features for an operational system, such as end-of-line resistors, are not shown.

**Figure 5-1. Individual Building Mass Notification System:
Separate Fire Alarm System and MNS
(Navy)**

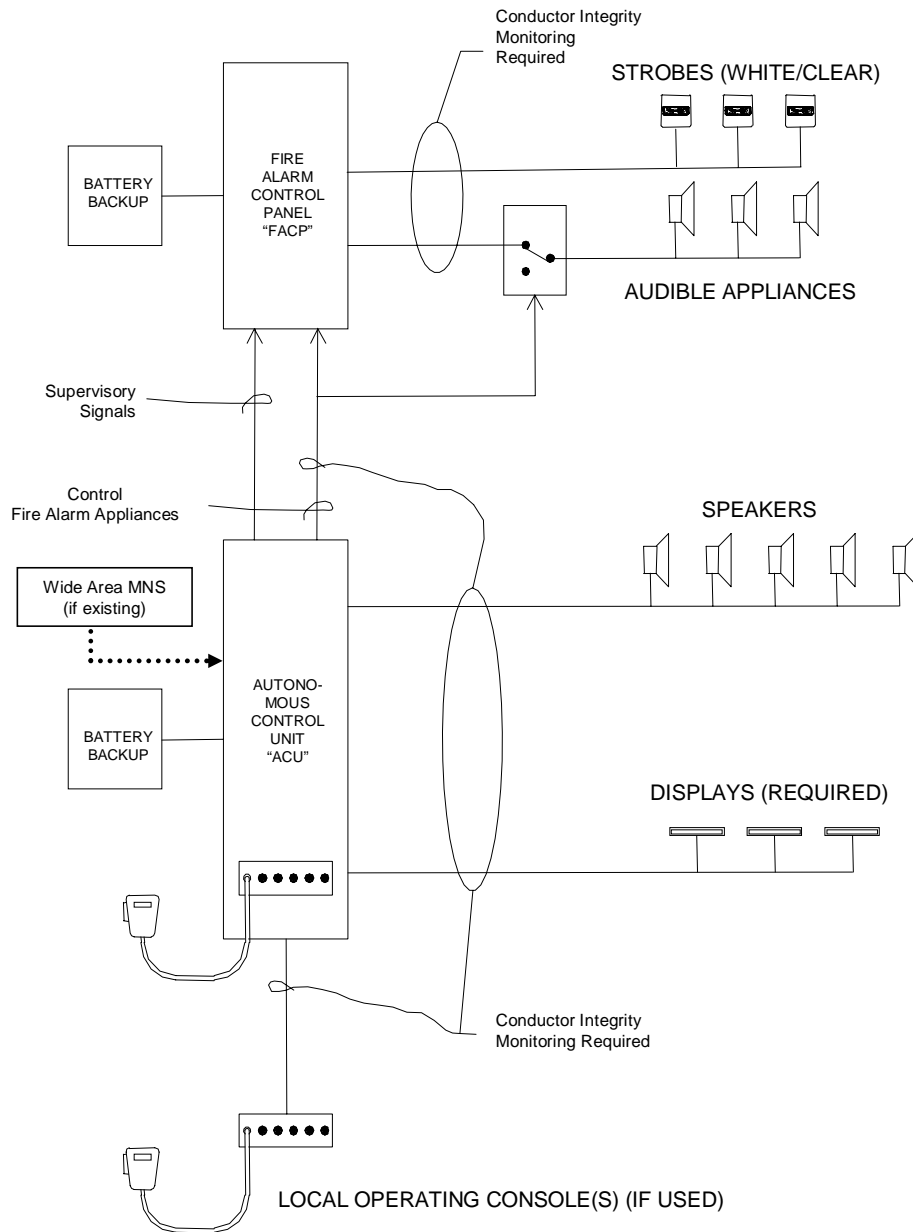

**Figure 5-2. Individual Building Mass Notification System:
Separate Fire Alarm System and MNS
(Army and Air Force)**

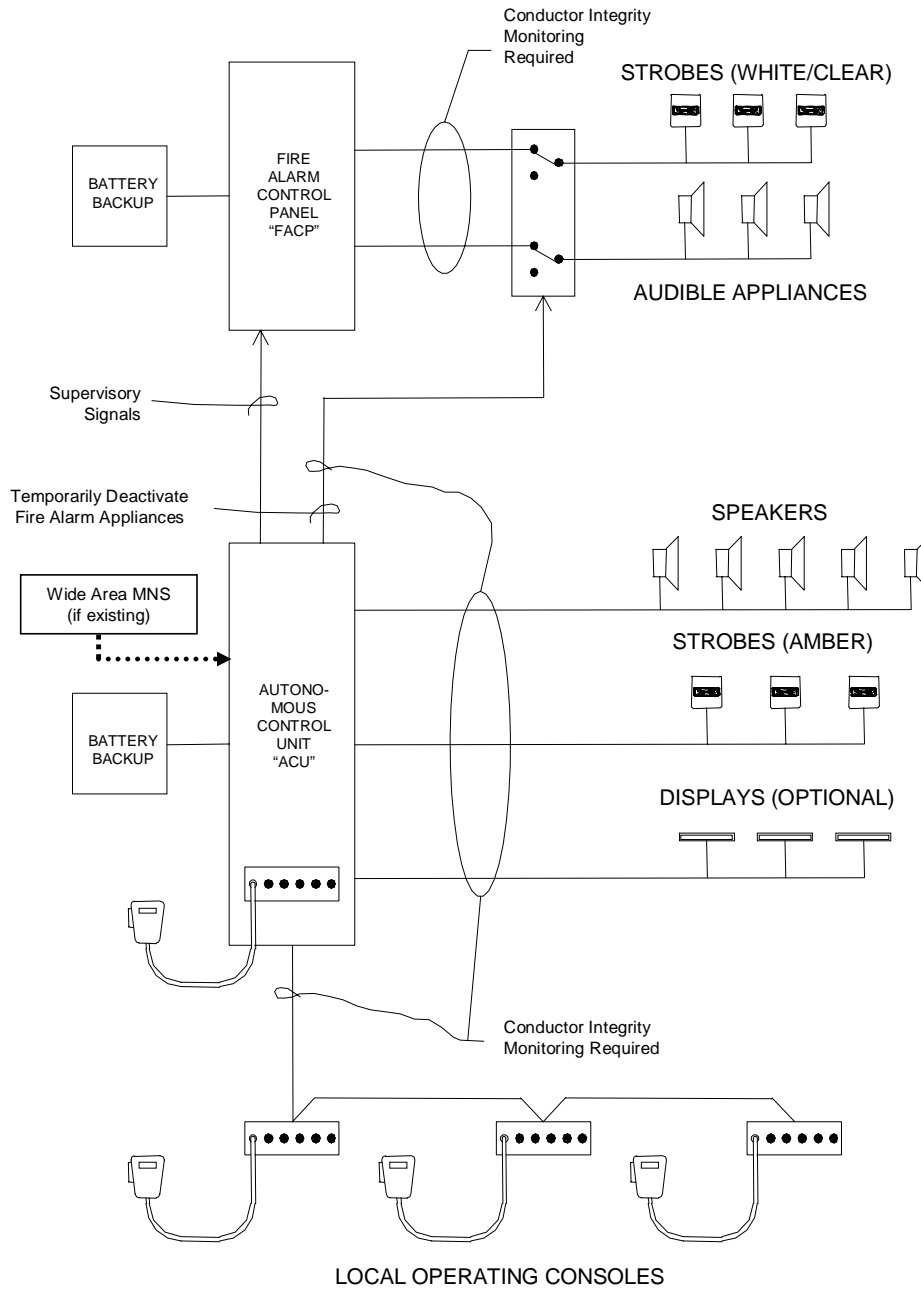

**Figure 5-3. Individual Building Mass Notification System:
Separate Fire Alarm System and MNS
(Marine Corps)**

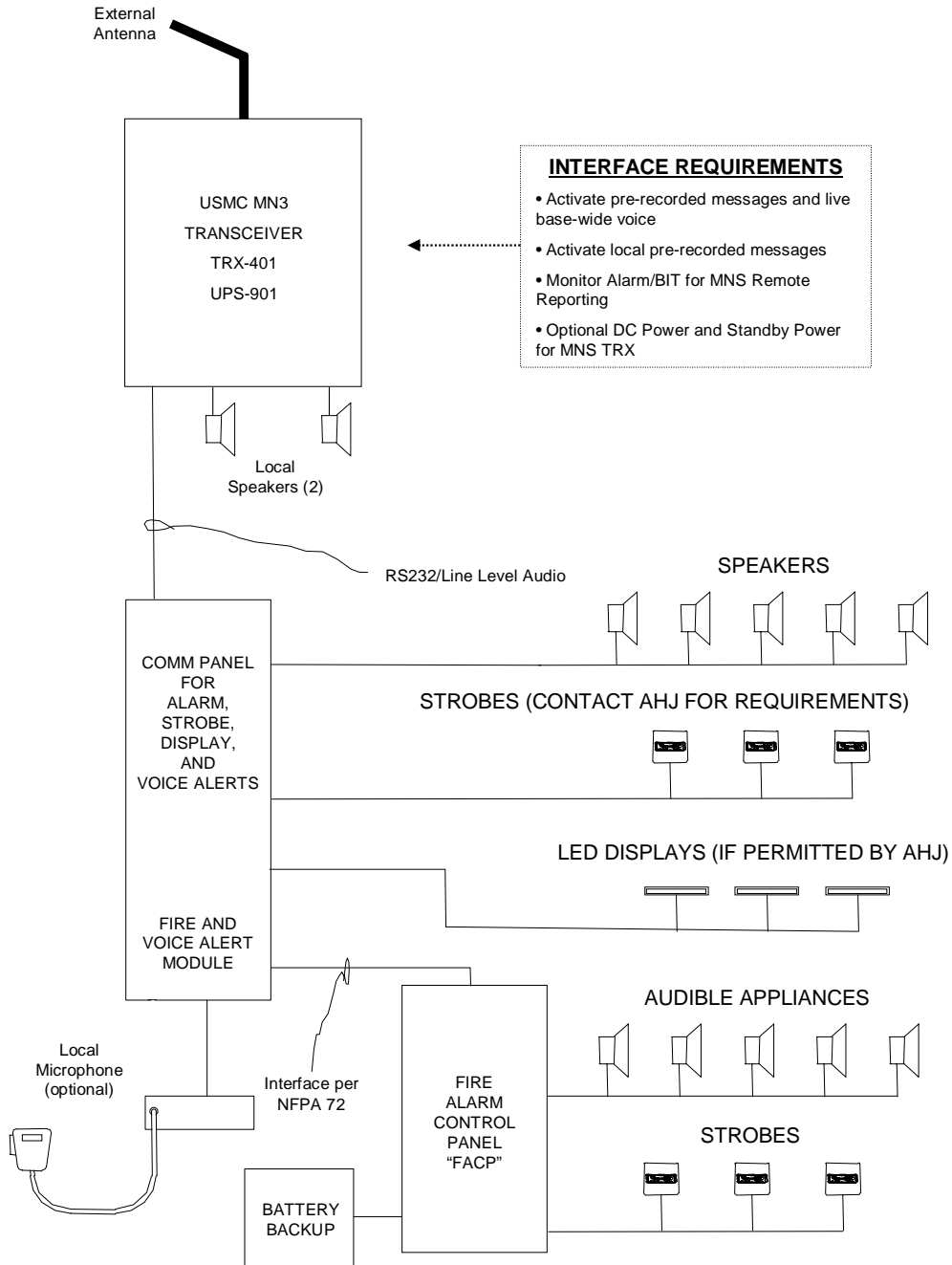

**Figure 5-4. Individual Building Mass Notification System:
Speakers Shared by Fire Alarm System and MNS
(Navy)**

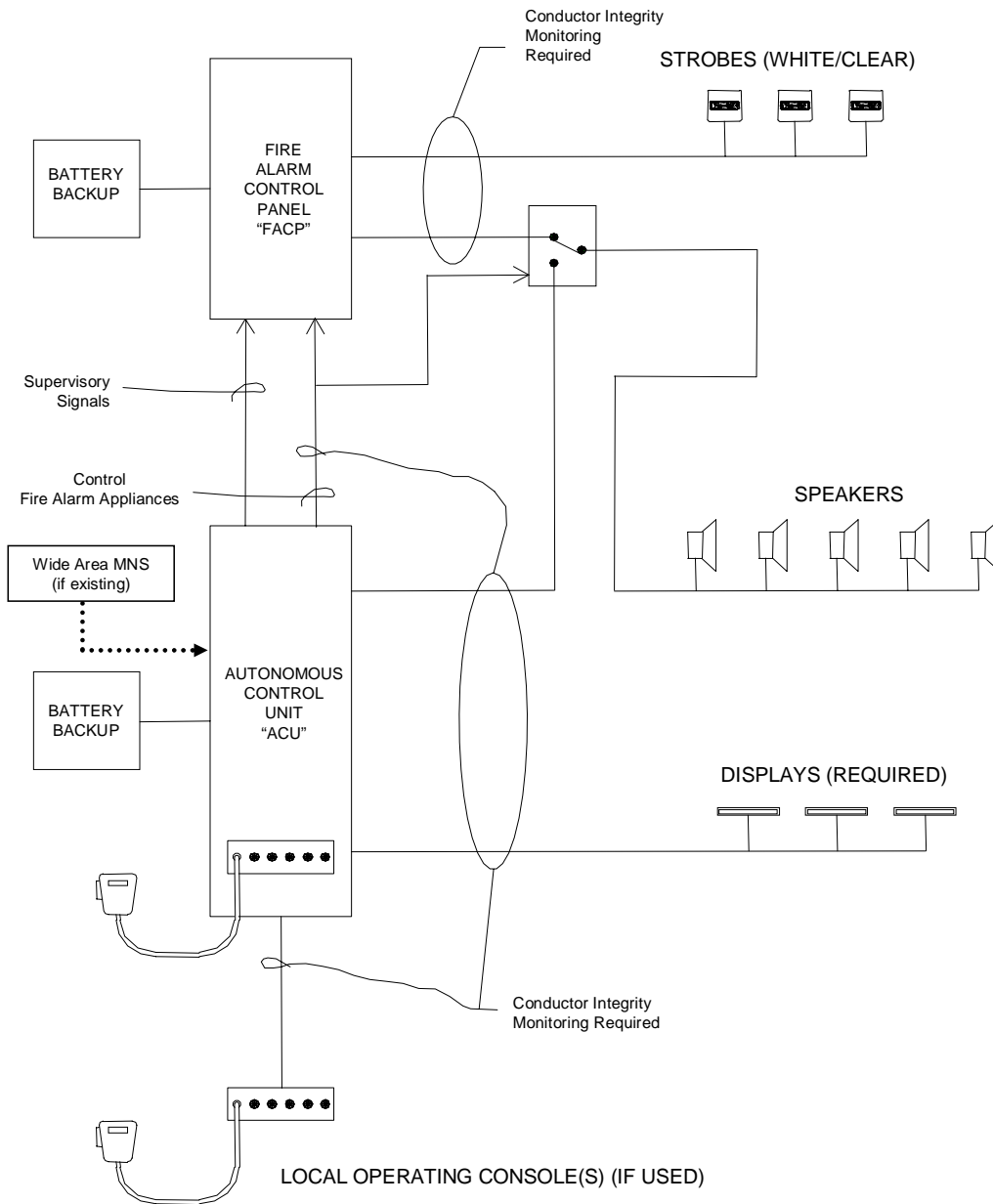

**Figure 5-5. Individual Building Mass Notification System:
Speakers Shared by Fire Alarm System and MNS
(Army and Air Force)**

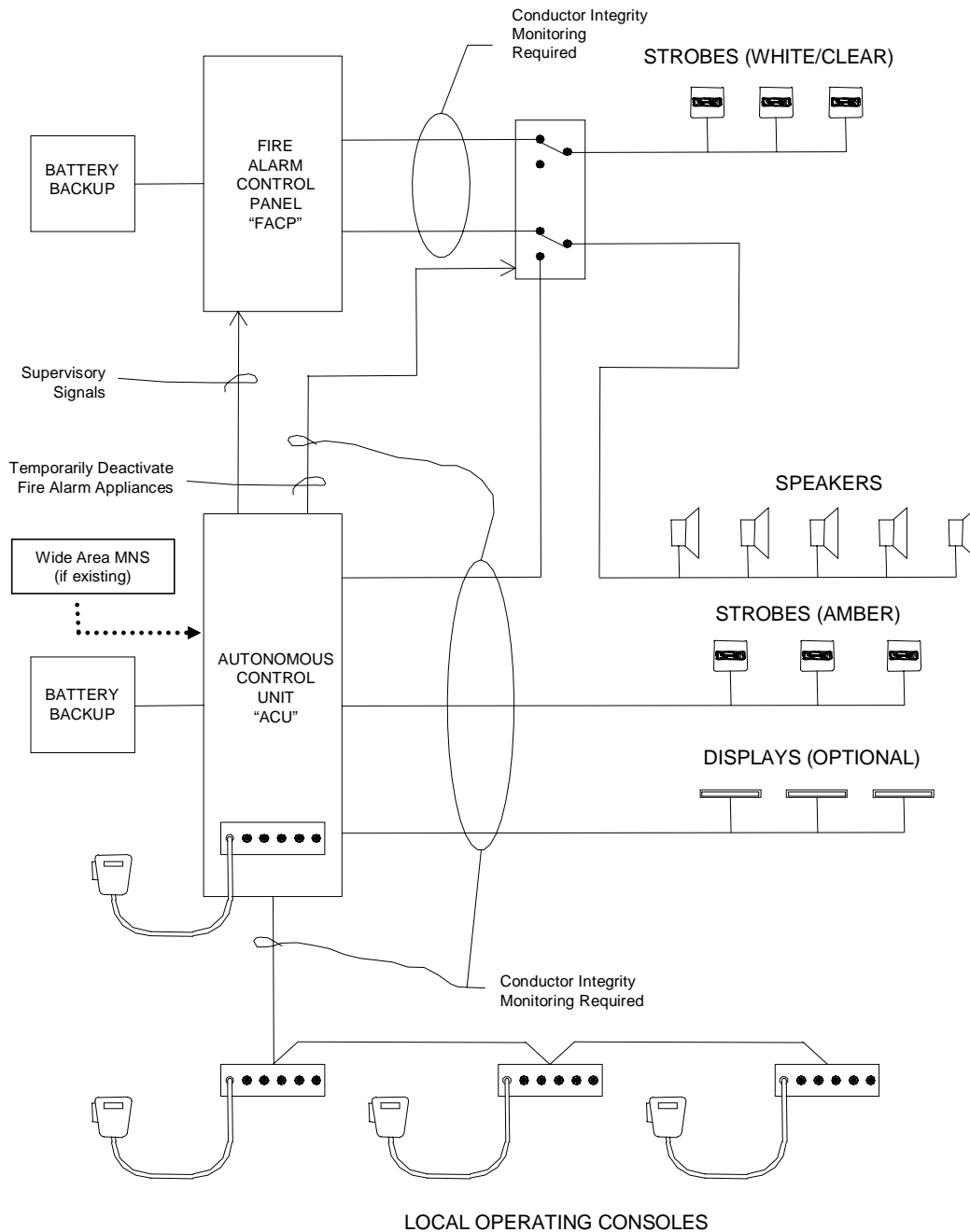

Figure 5-6. Use of Existing Public Address System: Navy

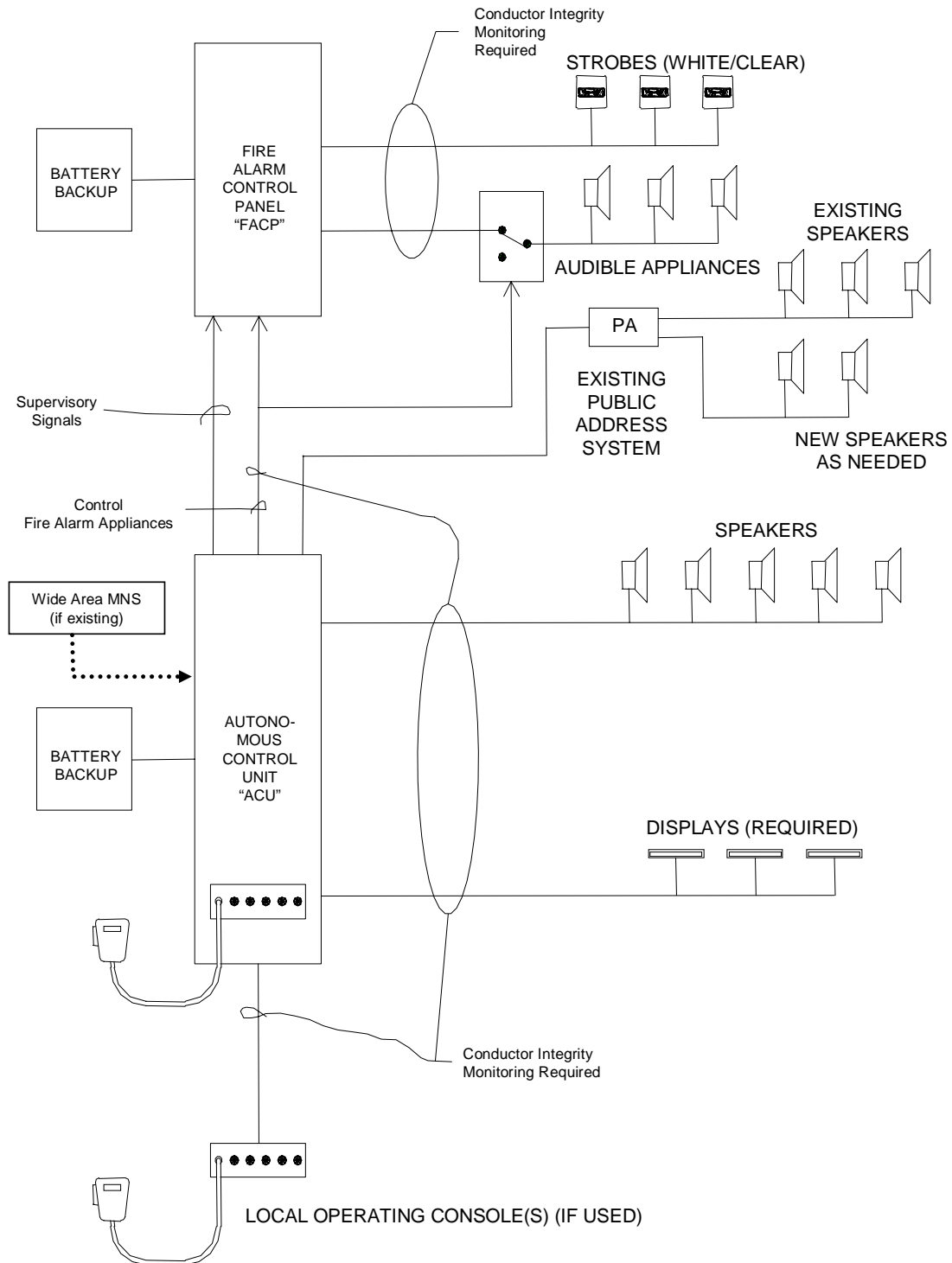
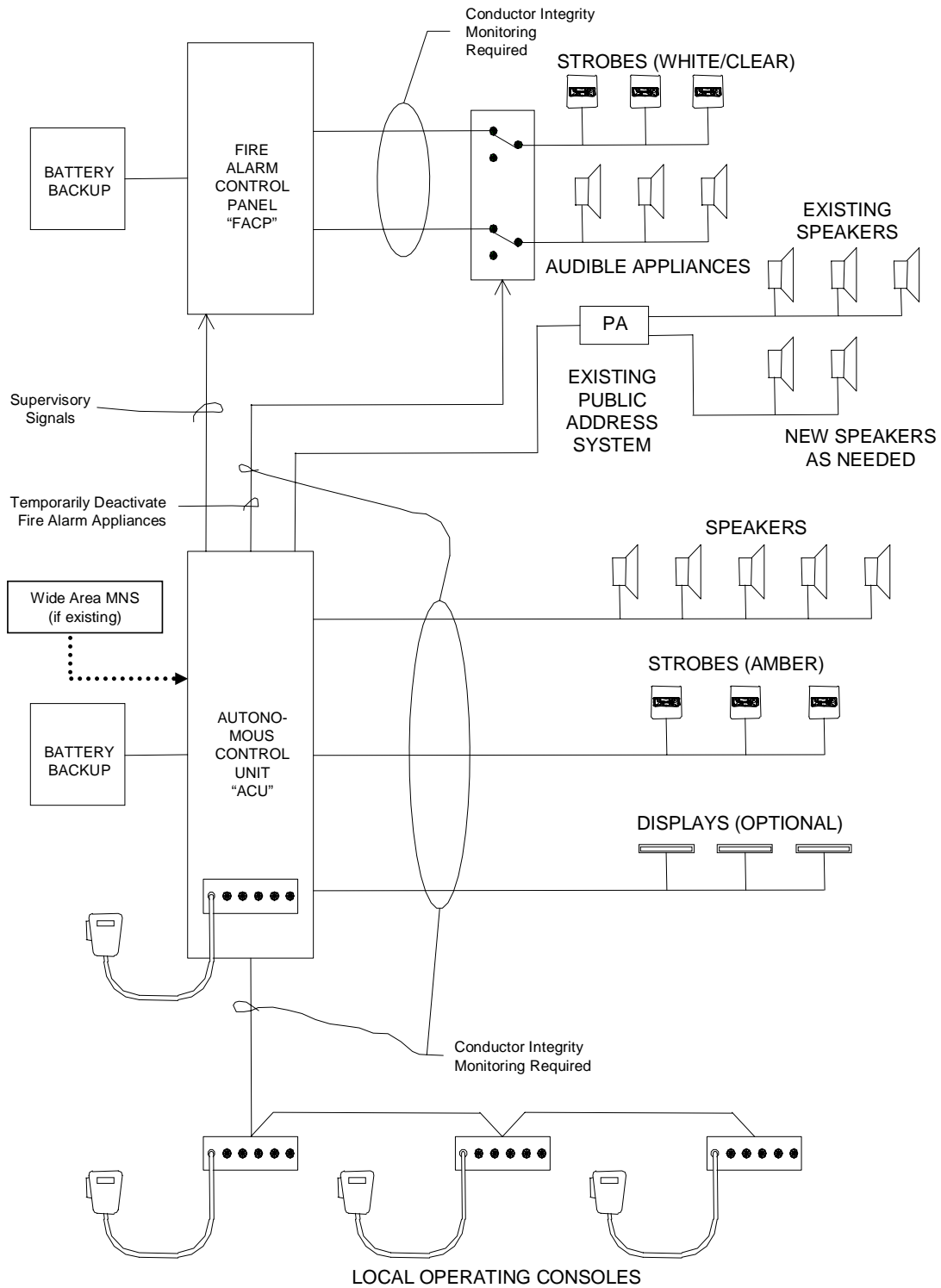

Figure 5-7. Use of Existing Public Address System:
Army and Air Force



5-5 **ACU**

5-5.1 **Location.** Install the ACU at the location normally specified by the DOD component AHJ for a stand-alone FACP.

5-5.2 **Design Features.** The ACU shall:

- Be able to function independently upon failure of the wide area MNS (if provided on the DOD installation).
- Meet UL Standard 864 or UL Standard 2017, and meet the MNS requirements in NFPA 72 and the specific requirements of this UFC. The listing evaluation shall be accomplished by UL, FM, or another NRTL.
- Be able to activate strobes and text signs:
 - Navy: Energize LED-type text signs. Text signs are required over the door to each egress stairwell and over (or adjacent to) the substantial means of egress from the level of discharge. Exterior exit doors from a single room (e.g., mechanical or electrical rooms) do not require a text sign.
 - Marine Corps: Contact the AHJ for guidance on visual notification appliances.
 - Army and Air Force: Energize a set of amber strobe lights marked "ALERT" for the MNS. Simultaneously de-energize clear/white strobe lights used by the fire alarm system. Energize LED-type text signs if required by the DOD installation.
- Make general paging or other non-emergency messages available without the activation of strobes. A separate microphone must be provided for this purpose.
- Be able to interrupt PA system announcements and to silence building background music while delivering voice messages.
- Be able to accept voice messages from the DOD installation telephone system.
- Have conductor connections that comply with NFPA 72.

Note: Ethernet or IP connections for initiating and indicating circuits are not currently available that will meet NFPA 72 requirements and, therefore, may not be used. Additionally, all software and hardware to be installed on DOD Ethernet or Internet systems must first successfully complete an accreditation process. Accreditation often takes a relatively long time.

- Have conductor integrity monitoring for strobes, speaker wiring, power supplies, and connections to LOC.
- Be able to switch between MNS and fire alarm notification functions without generating trouble alarms in either system.
- Have the capacity for multiple pre-recorded messages (at least eight, but more if required by the DOD installation). Pre-recorded messages shall be passed in the English language and, for OCONUS locations, also in the predominant language(s) used by the host nation. Pre-recorded messages, if used, should address at least these subjects:
 - Bomb threat or actual bomb within/around the building
 - Intruder/hostile person sighted within/around the building
 - Directions to occupants to take cover within the building
 - Evacuation of the building using exits other than the normal main entrance/exit (since the front entrance/exit is often a location targeted by terrorists)
 - Emergency weather conditions appropriate for the local area
 - “All Clear” message
 - A test message intended for verifying functionality of the system
-  Marine Corps AHJ will determine the number and content of pre-recorded messages.
- Be able to deliver messages quickly.
- Be able to automatically repeat pre-recorded messages until they are terminated.
- Have a microphone for delivering live voice messages.
- Provide adequate discrete outputs to initiate text signs and MNS strobes, and de-energize fire alarm strobes.
- Interface to the LOC for initiating recorded messages and delivering live voice messages from locations in the building other than at the ACU.
- Establish priority for passing messages to prevent interference between the ACU, LOC, and the wide area MNS on the DOD installation.

- Interface with the FACP to override fire alarm audible and visual notification appliances. The FACP shall provide supervised circuit integrity of interconnecting wiring between the MNS and FACP.
- Allow the MNS to temporarily override fire alarm audible messages and visual signals, and to provide intelligible voice commands during simultaneous fire and terrorist events. All other features of the fire alarm system, including the transmission of signals to the fire department, shall function properly. MNS messages shall take priority and continue to override fire alarm audible messages until the MNS message is either manually or automatically ended. If not manually ended, the MNS message will automatically end after 10 minutes.
- Provide a supervisory signal if the MNS is used to override fire alarm audible messages and visible signals during simultaneous fire and terrorist events. The supervisory signal shall be annunciated at the FACP and any remote fire alarm annunciators, and be transmitted to the fire department. The visual annunciation of the separate supervisory signal shall be distinctly labeled or otherwise clearly identified.

 The Army requires that this supervisory signal be separate from other fire alarm system supervisory signals.

- Provide remote monitoring of trouble, supervisory, and alarm functions to a constantly occupied location. This may be the same location that receives fire alarm system signals or to the central control units of the wide area MNS on the DOD installation.
- Provide a single switch or operating mechanism capable of shutting down all HVAC equipment in the facility in accordance with the requirements of UFC 4-010-01. If permitted by the DOD installation, this shutdown capability may be provided at a LOC or be deleted entirely if the capability is otherwise provided at a location readily accessible to building occupants.
- Provide a complete set of self-diagnostics for the controller and appliance network.
- Have a local diagnostic information display.
- Have a local system event log file.

5-5.3 **Off-the-Shelf Equipment.** ACU equipment furnished as part of the individual building MNS shall be COTS and shall be tested to the standards of UL or FM by a NRTL.

5-5.4 **Programming Codes.** All programming codes or passwords required to access, update, modify, and maintain the ACU shall be provided to the DOD installation no later than the date of final system acceptance.

5-5.5 **Power Supply Features.** The power supply shall:

- Be capable of accepting 120/240 VAC, 50/60 Hz.
- Be appropriate for a MNS that meets at least the minimum NFPA 72 requirements for standby power capacity. In addition, secondary (standby) power should be provided as follows: immediately upon loss of normal AC power, the standby source of power shall provide a minimum of 60 minutes of mass notification at the maximum connected load.
- Disable use of any microphones intended solely for general paging or other non-emergency messages upon loss of normal AC power.
- Conform to applicable sections of NFPA 72.
- Use only COTS components.
- Provide surge protection in accordance with UFC 3-520-01.

5-6 **LOC**

5-6.1 **Locations.** Provide LOC to allow emergency response forces and building occupants to access the MNS and originate messages in emergency situations from locations in the building other than from the ACU. Follow these requirements:

- Provide a separate LOC for use by the fire department near the building FACP (or fire command center) unless this is also the location of the ACU.
- Do not place a LOC inside of locked rooms or closets (with the possible exception of the LOC intended for use by the fire department near the FACP).
- Install LOC at those facility entrances/exits that will be used when building access is limited because of elevated terrorism threat levels.

Note: This LOC is intended to enable immediate notification of building occupants when unauthorized building access is threatened or has occurred at this location.

- Army and Air Force: Provide a LOC so that occupants do not need to travel a distance in excess of 61 m (200 ft) horizontally or to travel to other floors to access a LOC.
- Army and Air Force: Make LOC available for use by visitors in those facilities open to unescorted visitors or to the public.
- Navy: Provide no more than one LOC (if necessary) in addition to the ACU. Locate the LOC as directed by the responsible fire protection engineer.
- Marine Corps: Provide no more than one LOC (if necessary) in addition to the ACU. Locate the LOC as directed by the AHJ.

5-6.2 **Design Features.** The LOC shall:

- Have a remote microphone station that emulates operation of the MNS from the ACU.
- Have an easy method (such as individual manual activation push buttons) of activating the MNS pre-recorded messages. Signage shall be provided to allow rapid recognition of the means of initiating the pre-recorded messages.

 Activation of MNS pre-recorded messages is not required for Marine Corps LOC.

- Provide a single switch or operating mechanism capable of shutting down all HVAC equipment in the facility in accordance with the requirements of UFC 4-010-01. If permitted by the DOD installation, this shutdown capability may be provided at only one LOC when multiple LOCs are installed, or be deleted from all LOCs if the capability is otherwise provided at a location readily accessible to building occupants.
- Be protected in a small, wall-mounted enclosure.
- Have supplemental heating and ventilation for those enclosures located outdoors or in areas where the LOC will be exposed to temperatures or humidity outside of the manufacturer's design limits.
- Be protected from tampering by use of a break-glass, thumb-lock, tamper wire, tamper alarm, or equivalent protection. This is not required in those facilities with limited access so that unauthorized use would not reasonably be expected to occur. Enclosures that can be opened only by a key shall not be used.

 Marine Corps LOC may use key-operated locks when emergency response forces are provided with immediate access (e.g., master key, Knox-box®)

- Have signage on the outside of the enclosure similar to “Mass Notification” and “HVAC Emergency Shutdown” (if applicable).

5-7 NOTIFICATION APPLIANCE NETWORK

Note: Also see paragraph 6-5 for notification appliance requirements in special occupancies.

5-7.1 **Audible Appliance Network.** These are the requirements for the audible appliance network:

- Provide appliances capable of satisfying all UFAS and ADAAG.
- Use speakers suitable for the intended climatic and environmental conditions.
- Use speakers suitable for installation in commercial/industrial applications with consideration of electrically hazardous (classified) locations.
- Provide speakers and installation methods compliant with DCID 6/9 for areas classified as SCIF.
- Network design shall comply with NFPA 72.
- Speakers shall meet the listing requirements of UL Standard 1480.
- Provide speakers at all locations inside a building where the building fire alarm must be audible.
- Provide speakers mounted on the exterior of the building to provide notification of any areas commonly used by building occupants. These include courtyards, covered break areas, designated smoking areas, and sidewalks leading from the building’s exit doors to a public street or from parking areas for a distance up to 5 m (16 ft) from the building. Use speakers with directional characteristics that transmit minimal backplane noise when mounted on the sides of the building. Generally, the speakers should be located near entrance/exit doors.
- Provide an effective voice communication within buildings using a design including many speakers, each with low audio intensity.
- Install speakers with field-adjustable tap settings to allow adjustment after installation to meet audibility and intelligibility requirements.

- Do not use speakers exceeding 15 W for indoor applications without prior approval of the AHJ.

5-7.1.1 **Speaker Design Recommendations**

- Speakers rated at 2 W or less and provided with multiple tap settings to adjust the output power can often provide acceptable sound quality in most occupied areas.
- Speakers rated at 8 W or less and provided with multiple tap settings can often provide acceptable sound quality for most large or very noisy areas.
- Speakers rated at 8 to 10 W for interior distribution should be used when the speakers are also intended to meet the better sound quality normally expected from PA systems. These speakers should be capable of a frequency response over the range of at least 200 to 10,000 Hz.

Note: Such speakers are often adjusted to operate at a tap setting of 2 W or less, but are used because their sound quality is greatly superior to the small speakers typically used in fire alarm systems.

- Wiring methods shall comply with NFPA 72. Class B wiring is permitted unless Class A wiring is required for fire alarms systems on the DOD installation.

5-7.1.2 **Navy- and Marine Corps-Specific Requirements**

- Verify intelligibility by measurement after installation.
- Ensure that a CIS score greater than 0.7 is provided in each area where building occupants normally could be found.
- Areas of the building provided with hard wall and ceiling surfaces (such as metal or concrete) that are found to cause excessive sound reflections may be permitted to have a CIS score less than 0.7 if approved by the DOD installation, and if building occupants in these areas can determine that a voice signal is being broadcast and they must walk no more than 10 m (33 ft) to find a location with at least a 0.7 CIS score.
- Areas of the building where occupants are not expected to be normally present are permitted to have a CIS score less than 0.7 if personnel can determine that a voice signal is being broadcast and they must walk no more than 15 m (50 ft) to a location with at least a 0.7 CIS score.

- Measurements should be taken near the head level applicable for most personnel in the space under normal conditions (e.g., standing, sitting, sleeping, as appropriate).
- Commercially available test instrumentation shall be used to measure intelligibility as specified by IEC 60849 and IEC 60268-16. The mean value of at least three readings shall be used to compute the intelligibility score at each test location.

Note: An STI score of 0.5 is considered equivalent to a CIS score of 0.7.

5-7.1.3 **Army- and Air Force-Specific Requirements**

- Verify intelligibility by measurement after installation.
- Ensure that a CIS score greater than 0.8 is provided in each area where building occupants normally could be found. Note: Values of 0.75 through 0.84 will be rounded to 0.8.
- Areas of the building provided with hard wall and ceiling surfaces (such as metal or concrete) that are found to cause excessive sound reflections may be permitted to have a CIS score less than 0.8 if approved by the DOD installation, and if building occupants in these areas can determine that a voice signal is being broadcast and they must walk no more than 10 m (33 ft) to find a location with at least a 0.8 CIS score.
- Areas of the building where occupants are not expected to be normally present are permitted to have a CIS score less than 0.8 if personnel can determine that a voice signal is being broadcast and they must walk no more than 15 m (50 ft) to a location with at least a 0.8 CIS score.
- Measurements should be taken near the head level applicable for most personnel in the space under normal conditions (e.g., standing, sitting, sleeping, as appropriate).
- Commercially available test instrumentation shall be used to measure intelligibility as specified by IEC 60849 and IEC 60268-16. The mean value of at least three readings shall be used to compute the intelligibility score at each test location.

Note: An STI score of 0.7 is considered equivalent to a CIS score of 0.8.

5-7.2 **Visual Appliance Network.** These are the requirements for the visual appliance network:

- Provide visual appliances capable of satisfying all UFAS and ADAAG.

- Use visual appliances suitable for the intended climatic and environmental conditions.
- Use visual appliances suitable for installation in commercial/industrial applications with consideration of electrically hazardous (classified) locations.
- Strobes shall meet the listing requirements of UL Standards 1638 and 1971. Text signs shall comply with UL Standard 48.
- Strobes are not required outside the building.
- Where more than two visible notification appliances are in any field of view, they shall flash in synchronization.
- Wiring methods shall comply with NFPA 72. Class B wiring is permitted unless required otherwise by the local AHJ.

5-7.2.1 **Navy-Specific Requirements**

- Provide clear strobes marked with the word “ALERT” for shared use by the facility’s MNS and FACP.
- Provide LED text signs. Text signs are required over the door to each egress stairwell and over (or adjacent to) the substantial means of egress from the level of discharge. Exterior exit doors from a single room (e.g., mechanical or electrical rooms) do not require a text sign. (See Chapter 7 for operational requirements and information on message content.)

5-7.2.2 **Marine Corps-Specific Requirements**

- Contact the AHJ for guidance on visual notification appliances.

5-7.2.3 **Army- and Air Force-Specific Requirements**

- Provide amber-colored strobes marked with the word “ALERT” to alert the hearing impaired. Provide these strobes in addition to existing clear strobes provided for the building fire alarm system.
- Amber strobes activated in conjunction with the delivery of a pre-recorded voice message shall operate continuously until message termination. Amber strobes activated in conjunction with the delivery of a live voice message shall operate during the message and for not less than 15 seconds after the message ends.

- Clear/white strobes activated by the fire alarm system shall not operate during those periods when the amber strobes are in operation, but otherwise shall operate continuously until the fire alarm system is reset.

5-8 **INTERFACES WITH WIDE AREA MNS.** The individual building MNS shall be capable of interfacing with an existing wide area MNS. If a wide area MNS is not presently provided on the DOD installation, the individual building MNS shall be designed to allow future interface with a wide area MNS procured from another manufacturer. The electrical requirements, computer codes, or other protocols that are needed to interface the systems shall be provided to the DOD installation. At a minimum, the wide area MNS shall be able to provide and the individual building MNS shall be able to receive an audio line-level input. The individual building MNS shall not be activated or controlled by a giant voice system unless the giant voice system also meets the design and performance requirements of a wide area MNS.

CHAPTER 6

SPECIAL CONSIDERATIONS

6-1 **OVERVIEW.** DOD requirements for antiterrorism mandate the installation of individual building MNS during new construction and renovation projects. These systems are presently being installed on most DOD installations. Although not required by the DOD, use of a wide area MNS may be an important part of the antiterrorism strategy established by DOD installations.

6-2 **IMPLEMENTATION PLAN.** Each DOD installation should establish an implementation plan that establishes a comprehensive approach to MNS that is acceptable to security, communications, and fire protection engineering personnel. Elements of an implementation plan should include a needs assessment, requirements definition, alternatives evaluation, system selection, and implementation schedule. Some DOD installations may choose to first select and install a wide area MNS and subsequently install an individual building MNS that is compatible with the wide area MNS. This is not required by the DOD but will immediately increase the readiness of the DOD installation to respond to terrorist and other threats. Other DOD installations may choose to install individual building MNS in new construction and renovation projects, and also in their most significant and important facilities. This approach will spread the cost of installation over a longer time. The completed implementation plan will serve as a roadmap to address the specific needs and unique circumstances associated with each particular DOD installation.

6-3 **GIANT VOICE SYSTEM.** Some DOD installations are currently provided with a giant voice system for outdoor notification. Many of these systems were designed in the Cold War era and were intended to transmit tones signals, not voice signals. These systems may not adequately provide intelligible voice signals over much of the DOD installation. Closer spaced and less powerful speaker arrays are often required to achieve adequate intelligibility. Existing giant voice systems often have proved unsatisfactory in providing intelligible messages between multi-story buildings in high population density areas (such as industrial areas). Newer speaker technologies are available and should be considered for installation in these areas. Additionally, this UFC does not permit the use of giant voice systems inside of buildings because of the difficulty in achieving acceptable intelligibility of voice messages, the need to monitor circuit integrity, and the requirement to provide visual notification appliances for persons with hearing disabilities. This UFC does not permit an existing giant voice system to activate or control an individual building MNS unless the giant voice system fully complies with the requirements for a wide area MNS.

6-4 **TELEPHONE ALERTING SYSTEM.** A telephone alerting system may be useful in supplementing a wide area MNS and providing notification to building occupants where mass notification would not be required by UFC 4-010-01, such as in small facilities with only a few occupants and single-family and duplex

military family housing. Telephone alerting system services are sometimes outsourced to reduce the operation and maintenance burden on the base; however, outsourcing increases reliance on systems not under direct control of the facility being serviced and could impact the reliability or vulnerability of the telephone system capability.

6-5 SPECIAL OCCUPANCIES

6-5.1 **No Self-Preservation Capability.** This UFC does not require the installation of mass notification capability for those persons who are unable to protect themselves and could not take action without the assistance of others. Examples include prisoners in correctional facilities that are physically prevented from taking action or patients in a hospital that require assistance from the medical staff to take action. Mass notification capability is still required for the staff of these facilities so they may know to take action to protect themselves and those in their care. The appropriate approach for these facilities is to emulate the design solution that would be applied in that building for the installation of a new fire alarm system.

 Individual building MNS for Marine Corps projects shall serve as a subsystem of the wide area MNS as described in chapters 3 and 5.

6-5.2 **Not Occupied by Hearing Impaired Persons.** This UFC does not require the installation of visual notification signals in areas not subject to occupancy by persons who are hearing impaired, except that visual notification signals shall be provided in areas where hearing protection is worn due to high ambient noise levels.

Note: Visual notification signals must be provided even if the area is only accessed occasionally by personnel who are hearing impaired and granted unaccompanied access, such as maintenance or cleaning personnel, except for those areas listed in section 6-5.3.

6-5.3 **Housing and Lodging Facilities.** When MNS is required for personnel housing (such as barracks, dormitories, lodges, temporary or transient living facilities, and other sleeping quarters with 11 or more unaccompanied persons) or for military family housing (such as 13 or more family units in one building), audible and visible MNS appliances shall be provided.

6-5.3.1 Audible appliances, including in sleeping areas, shall provide a sound level of at least 15 dBA above the average ambient sound level and at least 5 dBA above the maximum sound level having a duration of at least 60 seconds, and they shall provide a CIS score equal to or greater than 0.7 (Navy and Marine Corps) or 0.8 (Army and Air Force). Sleeping areas shall also be provided with a minimum sound level of 75 dBA unless a CIS score equal to or greater than 0.7 (Navy and Marine Corps) or 0.8 (Army and Air Force) is provided.

6-5.3.2 Visual appliances are not required within private living and sleeping

rooms except those that are specifically designated by the DOD installation for the accommodation of hearing-impaired individuals. Visual notification appliances shall be provided in other general usage areas such as common rooms, day rooms, meeting rooms, hallways, corridors, lobbies, and public restrooms.

CHAPTER 7

OPERATIONAL CHARACTERISTICS

7-1 **INTRODUCTION.** This chapter provides a description of the most significant operating characteristics of wide area MNS and individual building MNS.

7-2 **WIDE AREA MNS**

7-2.1 **Central Control Stations.** A primary and backup central control station are provided. At each central control station, a computer with a GUI is provided. With the GUI, the system operator can send live voice signals using a microphone and can send or activate pre-recorded voice signals, tones, and music signals. The signals can be sent to individual buildings, zones of buildings, individual outdoor speaker arrays, zones of outdoor speaker arrays, or to the entire DOD installation. Different signals can be sent to different locations. The central control station can receive voice signals by telephone or radio and patch those signals through to desired locations on the DOD installation. Music, such as Reveille and the national anthem, can be transmitted throughout the DOD installation. The central control station automatically or manually assigns priorities to all transmitted signals.

7-2.2 **Regional or National Command Centers.** When required by the DOD component, those signals transmitted on the DOD installation that meet a screening criteria for priority are automatically relayed to a regional or national command center, or to nearby DOD installations that have a need to know of the emergency.

7-2.3 **Public Alert and Warning System.** This national system is under development by the Department of Homeland Security as directed by Executive Order 13407. DOD systems are required by this same Executive Order to coordinate with the national system. The wide area MNS will be designed with the capability to receive, record, and distribute voice messages and alert signals received from the Commander-in-Chief through the national public alert and warning system. This will permit the central control station to immediately distribute the voice messages or alert signals, or to delay the distribution as necessary to meet operational requirements as approved by the DOD installation commander.

7-2.4 **HPSA.** Designated HPSAs are provided with a microphone to enable an on-scene commander, security forces, or others (such as a drill instructor) to use the HPSA for local announcements and instructions. In some cases, individual speakers or all speakers of these arrays may be locally selected and energized. The speakers for these arrays will be highly directional when designed to permit operation from a location directly below the speakers without feedback or harmful sound pressure levels.

7-2.5 **Supplemental Mass Notification Delivery Systems.** The wide area MNS can also interface with and control other notification systems such as telephone dialers, tone alert systems, computer network alerting systems, pagers, facsimile machines, and vehicular traffic directional control signs. Text notification via wireless devices and desktop computer notification are effective means for delivering mass notification messages to multiple recipient groups. Wireless text messaging is effective in reaching off-base personnel. This is especially useful for OCONUS locations. Desktop notification is particularly effective when more complex information must be conveyed, and can be a cost-effective interim solution prior to installing an individual building MNS.

Note: See Appendix C for a discussion of requirements for Internet-based communication systems (under development).

7-3 INDIVIDUAL BUILDING MNS

7-3.1 **Combined Systems.** In new construction, mass notification and fire alarm functions are combined into one system. PA may also be combined into this system. In renovation projects, combined systems are preferred, but separate systems may be permitted in some applications. The mass notification functions can temporarily disable the fire alarm notification appliances to allow intelligible voice announcements when needed in the case of simultaneous terrorist and fire events. This is necessary because arson and unauthorized fire system activation are methods of attack that have been used previously by terrorists.

 Individual building MNS for Marine Corps projects shall serve as a subsystem of the wide area MNS as described in Chapters 3 and 5, and might not interface with the fire alarm system.

7-3.2 **LOC.** These consoles are provided to allow building occupants and emergency response forces to operate the system and provide live voice or pre-recorded messages to personnel in the building. They also enable the building occupants to completely shut down the heating, ventilating, and air conditioning system as needed to respond to a terrorist event or external natural disaster. Army and Air Force systems permit most building occupants to access the LOC, and use tamper-resistant features to minimize unauthorized use. The Navy limits access to the LOC to emergency response forces and a few of the building occupants, such as the building manager, security staff, or the commanding officer's staff. The Marine Corps does not provide a LOC but does provide a remote microphone.

7-3.3 **ACU.** The ACU has the same capabilities to operate the system as a LOC, plus the ability to override or disable the mass notification capability. Access to the ACU is limited to emergency response personnel.

7-3.4 **Notification Appliances.** Speakers are used to provide intelligible voice signals for mass notification. Strobes are used to meet the accessibility

requirements for those persons with hearing disabilities. The Army and Air Force use amber-colored strobes to alert those with hearing disabilities. The Navy uses one set of clear strobes for both fire and mass notification. These strobes are marked "ALERT" instead of "FIRE". The Navy also uses text signs to assist persons with hearing disabilities. These signs read "EVACUATE" when the fire alarm system is in alarm. The signs read "ANNOUNCEMENT" when a mass notification message is being transmitted, and the text sign will continue for 10 seconds after the end of the announcement. Text signs are required over the door to each egress stairwell and over (or adjacent to) the substantial means of egress from the level of discharge. Exterior exit doors from a single room (e.g., mechanical or electrical rooms) do not require a text sign.

Note: The Marine Corps uses notification appliances as specified by the AHJ.

CHAPTER 8

MAINTENANCE

8-1 **INTRODUCTION.** This chapter was developed on the basis of recommendations from MNS manufacturers, as well as experience with similar computer-based systems. Maintenance requirements established for each MNS must consider the manufacturer's maintenance recommendations and the applicable DOD maintenance requirements. MNS shall be maintained so that they comply with the minimum operating parameters recommended by the manufacturer.

8-2 **MAINTENANCE RESPONSIBILITIES.** DOD components that have assigned maintenance responsibilities include:

8-2.1 **Air Force.** Air Force communications squadrons are responsible for maintaining giant voice systems in accordance with AFI 21-116 on Air Force installations. Civil engineering squadrons are usually responsible for maintaining individual building MNS on Air Force installations that are designed and installed in accordance with this UFC.

8-2.2 **Marine Corps.** Headquarters Marine Corps (HQMC) Technical Service Agency is responsible for maintaining the MNS across the Marine Corps.

8-3 **QUALIFICATIONS OF MAINTENANCE PERSONNEL**

8-3.1 **Inspection, Testing, and Maintenance Tasks.** Only personnel trained and qualified in maintaining and repairing MNS will perform inspection, testing, and maintenance tasks. Most types of MNS use technology commonly found in fire alarm systems, giant voice, or other outdoor voice and siren warning systems, and similar maintenance skills are needed. If specific manufacturer training is available, maintenance personnel must satisfactorily complete the training to be considered qualified. If specific manufacturer training is not available for a MNS, personnel shall be considered qualified if they have achieved a NICET Level III in fire alarm systems or in low-voltage electronic communication systems, or have achieved the UL certification level for fire alarm systems. Tasks must be performed according to the manufacturer's instructions. Certain jurisdictions may require varying levels of continuing education to maintain recognized qualifications. Overseas locations should contact their command fire protection engineering office for guidance on appropriate qualifications. Military personnel who have satisfactorily completed the required schools in their career field in fire detection and alarm system maintenance or communications electronics are considered qualified.

8-3.2 Other Inspections. This UFC lists inspection tasks that must be performed during regularly scheduled facility inspections. Fire prevention, safety, and maintenance personnel, as well as other individuals familiar with MNS operations, shall perform these inspection tasks.

8-3.3 Maintenance Records. Each DOD installation must maintain a permanent record of completed inspection, testing, and maintenance tasks in accordance with each agency’s program for record keeping of recurring facility maintenance. Records may be hard copy or electronic. Where no DOD component-wide programs exist, records should be developed locally. Records must be maintained for every facility and must include, as a minimum, each task, the date scheduled, the date completed, and the name of the person completing the task.

8-4 INDIVIDUAL BUILDING MNS. See UFC 3-600-02, paragraph 2-2.2, “Fire Detection and Alarm Systems,” for applicable guidance on inspecting, testing, and maintaining engineered protection features in DOD facilities.

8-5 WIDE AREA MNS. Tables 8-1 and 8-2 provide maintenance information for the central control unit and communications network for a wide area MNS.

Table 8-1. Central Control Unit Maintenance

Frequency	Component	Tasks
Weekly	Central control unit, diagnostic log files	<ul style="list-style-type: none"> • Review the event log file; verify that the correct events were logged. • Review the system diagnostic log file; correct deficiencies noted in the file.
	Central control unit, hard drive	<ul style="list-style-type: none"> • Delete unneeded log files. • Delete unneeded error files. • Verify that sufficient free disk space is available.
	System – Functional test	Send out an alert to a small set of pre-designated receiving devices and confirm receipt.
	System – Security	If remote control software is loaded onto the system, verify that it is disabled to prevent unauthorized system access.

Frequency	Component	Tasks
Monthly	System – Functional test	Send out an alert to a diverse set of pre-designated receiving devices and confirm receipt. Include at least one of each type of receiving device.
	Central control unit, reset	Power down the central control unit computer and restart it.
Quarterly	System – Software backups	Make a full system software backup. Rotate backups based on the accepted practice at the site.
	Central control unit, computer	<ul style="list-style-type: none"> • Verify proper operation of the computer. • Defragment the hard drive. • Verify unobstructed flow of cooling air. Clean filters. Remove dust buildup on cooling fans, cooling fins, and air intake vents.
	Central control unit, uninterruptible power supply (UPS)	<ul style="list-style-type: none"> • Verify that the system will operate in the absence of line power; discontinue line power to the system and verify functionality. • Test the UPS. See NFPA 70B.
Yearly	System – Software backups	Test the current software backup system by installing the system backup.
	Central control unit, operation	<ul style="list-style-type: none"> • Verify the content of pre-recorded messages. • Verify activation of the correct pre-recorded message based on a selected event. • Verify activation of the correct pre-recorded message based on a targeted area. • Verify that the central control unit security mechanism is functional.

Table 8-2. Communications Network Maintenance

Frequency	Component	Tasks
Weekly	Central control console	Verify that no diagnostic failures are indicated.
Monthly	HPSA/Wireless transceivers	Perform silent activation and/or health monitoring of all components.
	Total system functionality	<ul style="list-style-type: none"> • Perform a test system activation for a particular zone/building/area. • Verify that field components perform as expected.
Quarterly	Central control unit, UPS	<ul style="list-style-type: none"> • Verify that the system will operate in the absence of line power; discontinue line power to the system and verify functionality. • Test the UPS. See NFPA 70B.
Every 6 months	Field components	<ul style="list-style-type: none"> • Perform a visual inspection of all components. Verify that enclosure integrity is not compromised. • Perform a visual inspection of the antenna. Verify a solid connection and no corrosion. • Perform a visual inspection of the transceivers. Verify proper operation. • Generate a conductor integrity monitor alarm. Verify the alarm status on the central console. • Disconnect AC power. Verify the AC power failure alarm status on the central console. • Disconnect AC power. Verify the battery voltage under load.
Every 6 months	Wireless signals	Check forward/reflected radio power.

GLOSSARY

Acronyms and Abbreviations

AC—alternating current

ACU—autonomous control unit

ADAAG—Americans with Disabilities Act Accessibility Guidelines

AFB—Air Force base

AFI—Air Force instruction

AHJ—authority having jurisdiction

ANSI—American National Standards Institute

APCO—Association of Public-Safety Communications Officials

C—Celsius

CAC—Common Access Card

CAP—common access protocol

CD—compact disk

CIS—Common Intelligibility Scale

CNO—Chief of Naval Operations

CON—certificate of networthiness

CONOPS—concept of operations

CONUS—continental United States

COTS—commercial off-the-shelf

CSC-STD—DOD Computer Security Center Standard

CTO—certificate to operate

dBA—sound/noise power, adjusted, in decibels

DCID—Director of Central Intelligence Directive

DD—Department of Defense (as used on forms)

DIACAP—DOD Information Assurance Certification and Accreditation Process

DITSCAP—DOD Information Technology Security Certification and Accreditation Process

DOD—Department of Defense

EM—emergency management

EMWIN—Emergency Managers Weather Information Network

EOC—emergency operations center

EPROM—erasable programmable read-only memory

F—Fahrenheit

FACP—fire alarm control panel

FCC—Federal Communications Commission

FEMA—Federal Emergency Management Agency

FM—Factory Mutual Research Corporation

FPCON—force protection condition

ft—feet

GPS—Global Positioning System

GUI—graphical user interface

HAZMAT—hazardous materials

HPSA—high power speaker array

HQ AFCESA/CEO—Air Force Civil Engineer Support Agency, Operations and Programs Support Directorate

HQ DLA-D—Defense Logistics Agency Director

HQ DLA-DES-SE—Defense Logistics Agency, Support Services

HQ USACE/CECW-CE—U.S. Army Corps of Engineers, Directorate of Civil Works, Engineering and Construction

HQMC CODE PS—U.S. Marine Corps, Critical Infrastructure Assurance Branch

HVAC—heating, ventilation, air conditioning

Hz—hertz

ICC—installation control center

IEC—International Electrotechnical Commission

INWS—installation notification and warning system

IP—Internet Protocol

kHz—kilohertz

km/h—kilometers per hour

LDAP—Lightweight Directory Access Protocol

LED—light-emitting diode

LOC—local operating console

m—meter

MCO—Marine Corps Order

MEP—mobile electrical power

METOC—meteorology and oceanography

MIL-STD—military standard

MNS—mass notification system

MPEG—Moving Picture Experts Group

mph—miles per hour

NAVFACENGCOM HQ Code CHE—Naval Facilities Engineering Command, Headquarters Chief Engineer's Office

NCAS—net-centric alerting system

NCEES—National Council of Examiners for Engineering and Surveys

NEMA—National Electrical Manufacturers Association

NFPA—National Fire Protection Association

NGA—National Geospatial-Intelligence Agency

NICET—National Institute for Certification in Engineering Technologies

NRTL—nationally recognized testing laboratory

NTIA—National Telecommunications and Information Administration

OCONUS—outside of the continental United States

OSHA—Occupational Safety and Health Administration

PA—public address

PC—personal computer

PDA—personal data assistant

ROC—regional operations center

SCIF—sensitive, compartmented information facilities

SE—Service Exception

STI—Speech Transmission Index

THD—total harmonic distortion

UFAS—Uniform Federal Accessibility Standards

UFC—Unified Facilities Criteria

UL—Underwriters Laboratories, Inc.

UPS—uninterruptible power supply

VAC—volts of alternating current

VoIP—voice over IP

XML—Extensible Markup Language

Terms

Contractor—An entity that executes work in accordance with a contract.

Giant Voice—A nickname for the wide area outdoor siren and voice signaling system often found on military bases. An earlier name for this system was “Big Voice.”

Mass Notification System—A system that provides real-time information to all building occupants or personnel in the immediate vicinity of the building during emergency situations.

System Integrator—A contractor that designs, fabricates, installs, starts up, tests, and documents electrical and electronic systems using COTS components manufactured by others. Qualified manufacturers can act as system integrators.

APPENDIX A

REFERENCES

GOVERNMENT PUBLICATIONS

Public Law

Americans with Disabilities Act Accessibility Guidelines for Buildings and Facilities (ADAAG), 2004, <http://www.access-board.gov/adaag/about/index.htm>.

Executive Order 13347, *Individuals with Disabilities in Emergency Preparedness* (69 FR 44573), 26 July 2004, <http://www.archives.gov/federal-register/executive-orders/2004.html>.

Executive Order 13407, *Public Alert and Warning System* (71 FR 36975), 28 June 2006, <http://a257.g.akamaitech.net/7/257/2422/01jan2006>.

National Technology Transfer and Advancement Act of 1995, (Public Law 104-113), 7 March 1996, <http://frwebgate.access.gpo.gov/cgi-bin/getdoc.publ113.104.pdf>.

Uniform Federal Accessibility Standards (UFAS), 1984, <http://www.access-board.gov/ufas/ufas-html/ufas.htm>.

Departments of the Army, Air Force, and Navy

AFI 10-2501, *Air Force Emergency Management (EM) Program Planning and Operations*, 24 January 2007, Air Force Civil Engineer Support Agency, 139 Barnes Dr, Suite 1, Tyndall AFB, FL 32403-5319, <http://www.e-publishing.af.mil/>.

AFI 21-116, *Maintenance Management of Communications-Electronics*, 19 April 2005, Secretary of the Air Force, 3400 Defense Pentagon, Washington, DC 20301-3400, <http://www.e-publishing.af.mil/>.

MCO 3302.1, *The Marine Corps Antiterrorism Order*, Headquarters United States Marine Corps, Washington, DC 20380-0001, <http://www.usmc.mil/directiv.nsf/publications>.

MCO 5530.14, *Marine Corps Physical Security Program Manual*, Headquarters United States Marine Corps, Washington, DC 20380-0001, <http://www.usmc.mil/directiv.nsf/publications>.

MIL-STD-3007F, *Department of Defense Standard Practice for Unified Facilities Criteria and Unified Facilities Guide Specifications*, 13 December 2006, Commander, Naval Facilities Engineering Command, Norfolk, VA 23508-1278, <http://www.wbdg.org/ccb/>.

UFC 3-310-01, *Structural Load Data*, 25 May 2005, Naval Facilities Engineering Command, 1322 Patterson Ave. SE, Suite 1000, Washington Navy Yard, D.C. 20374-5065, <http://www.wbdg.org/ccb/>.

UFC 3-520-01, *Interior Electrical Systems*, 10 June 2002, Air Force Civil Engineer Support Agency, 139 Barnes Dr, Suite 1, Tyndall AFB, FL 32403-5319, <http://www.wbdg.org/ccb/>.

UFC 3-600-02, *Operations and Maintenance: Inspection, Testing, and Maintenance of Fire Protection Systems*, 1 January 2001, Air Force Civil Engineer Support Agency, 139 Barnes Dr, Suite 1, Tyndall AFB, FL 32403-5319, <http://www.wbdg.org/ccb/>.

UFC 4-010-01, *DoD Minimum Antiterrorism Standards for Buildings*, 8 October 2003, Deputy Under Secretary of Defense (Installations and Environment), 3400 Defense Pentagon, Room 3C553, Washington, DC 20301-3400, <http://www.wbdg.org/ccb/>.

UFC 4-010-02, *DoD Minimum Standoff Distances for Buildings (FOUO)*, 8 October 2003, Deputy Under Secretary of Defense, Installations and Environment, Department of the Air Force, Washington, DC, <http://www.wbdg.org/ccb/>.

UFC 4-020-01FA, *Security Engineering: Project Development (FOUO)*, 1 March 2005, U.S. Army Corps of Engineers, 441 G. Street, NW, Washington, DC 20314-1000, <http://www.wbdg.org/ccb/>.

UFC 4-020-02FA, *Security Engineering: Concept Design (FOUO)*, 1 March 2005, U.S. Army Corps of Engineers, 441 G. Street, NW, Washington, DC 20314-1000, <http://www.wbdg.org/ccb/>.

Central Intelligence Agency

DCID 6/9, *Physical Security Standards for Sensitive Compartmented Information Facilities*, 18 November 2002, Central Intelligence Agency, Washington, D.C. 20505, <http://www.fas.org/irp/offdocs/dcid6-9.htm>.

Department of Commerce

National Telecommunications and Information Administration (NTIA) *Manual of Regulations and Procedures for Federal Radio Frequency Management*, 2003 (R 2006), Herbert C. Hoover Building (HCHB), U.S. Department of Commerce/NTIA, 1401 Constitution Avenue, N.W., Washington, D.C. 20230, <http://www.ntia.doc.gov/osmhome/redbook/redbook.html>.

Department of Labor, Occupational Safety and Health Administration (OSHA)

Title 29, Code of Federal Regulations (CFR), Part 1910.165, *Employee Alarm*

Systems, <http://www.gpoaccess.gov/cfr/index.html>.

29 CFR 1910.95, *Occupational Noise Exposure*,
<http://www.gpoaccess.gov/cfr/index.html>.

29 CFR 1926.52, *Occupational Noise Exposure*,
<http://www.gpoaccess.gov/cfr/index.html>.

Federal Communications Commission

Title 47, Code of Federal Regulations, Part 15, *Radio Frequency Devices*, 2006,
Federal Communications Commission, 445 12th Street SW, Washington, DC
20554, http://www.access.gpo.gov/nara/cfr/waisidx_02/47cfr15_02.html.

National Security Agency

CSC-STD-002-85, *DOD Password Management Guideline*, National Computer
Security Center (NCSC), National Security Agency, Fort George G. Meade,
Maryland 20755, <http://csrc.nist.gov/secpubs/rainbow/nsapubs.txt>.

NONGOVERNMENT PUBLICATIONS

American National Standards Institute (ANSI), S3.2-1989 (R1999), *Method for
Measuring the Intelligibility of Speech over Communications Systems*, 1819 L
Street NW, Washington, DC 20036, <http://ansi.org/>.

Association of Public-Safety Communications Officials (APCO) Project 25,
December 2002, *Standards for Public Safety Digital Radio*, 351 N. Williamson
Blvd., Daytona Beach, FL 32114-1112, <http://www.apcointl.org/index.html>.

International Electrotechnical Commission (IEC) 60268-16, 2003, *Objective
Rating of Speech Intelligibility by Speech Transmission Index*, 3, rue de
Varembé, P.O. Box 131, CH-1211 Geneva 20 Switzerland,
<http://www.iec.ch/index.html>.

IEC 60849, *Sound Systems for Emergency Purposes*, 1998, 3, rue de Varembé,
P.O. Box 131, CH-1211 Geneva 20 Switzerland, <http://www.iec.ch/index.html>.

National Fire Protection Association (NFPA) 70, *National Electrical Code®*, 2008,
1 Batterymarch Park, P.O. 9101, Quincy, MA 02169-7471, <http://www.nfpa.org>.

NFPA 70B, *Recommended Practice for Electrical Equipment Maintenance*, 2006,
1 Batterymarch Park, P.O. 9101, Quincy, MA 02169-7471, <http://www.nfpa.org>.

NFPA 72, *National Fire Alarm Code®*, 2007, 1 Batterymarch Park, P.O. 9101,
Quincy, MA 02169-7471, <http://www.nfpa.org>.

NFPA 101®, *Life Safety Code®*, 2006, 1 Batterymarch Park, P.O. 9101, Quincy,
MA 02169-7471, <http://www.nfpa.org>.

UL 48-2004, *Standard for Electric Signs*, Underwriters Laboratory, Inc., 333 Pfingsten Road, Northbrook, IL 60062-2096, <http://ulstandardsinfonet.ul.com>.

Underwriters Laboratory, Inc. (UL) 864-2007, *Standard for Control Units and Accessories for Fire Alarm Systems*, 333 Pfingsten Road, Northbrook, IL 60062-2096, <http://ulstandardsinfonet.ul.com>.

UL 1480-2005, *Standard for Speakers for Fire Alarm, Emergency, and Commercial and Professional Use*, Underwriters Laboratory, Inc., 333 Pfingsten Road, Northbrook, IL 60062-2096, <http://ulstandardsinfonet.ul.com>.

UL 1638-2003, *Standard for Visual Signaling Appliances-Private- Mode Emergency and General Utility Signaling*, Underwriters Laboratory, Inc., 333 Pfingsten Road, Northbrook, IL 60062-2096, <http://ulstandardsinfonet.ul.com>.

UL 1971-2006, *Standard for Signaling Devices for the Hearing Impaired*, Underwriters Laboratory, Inc., 333 Pfingsten Road, Northbrook, IL 60062-2096, <http://ulstandardsinfonet.ul.com>.

UL 2017-2005, *Standard for General-Purpose Signaling Devices and Systems*, Underwriters Laboratory, Inc., 333 Pfingsten Road, Northbrook, IL 60062-2096, <http://ulstandardsinfonet.ul.com>.

APPENDIX B

SAMPLE PRE-RECORDED MNS MESSAGES

B-1 **OVERVIEW.** Pre-recorded messages are not required but can prove beneficial in emergency situations. This appendix contains the sample text for pre-recorded MNS messages based on actual messages in use at several DOD installations. These sample messages are provided for information only to assist DOD installations in defining the content of their pre-recorded MNS messages. Each DOD installation should create MNS messages appropriate for its particular locale.

B-2 **SAMPLE PRE-RECORDED MESSAGES**

B-2.1 **ARMY: FORT XXX.** All messages were recorded in a female voice.

B-2.1.1 **Red-Fire.** Five seconds of siren are played, followed by the message:

“Attention, attention. A fire emergency has been reported. Please leave the building using the nearest exit.”

B-2.1.2 **Blue-Weather.** Five seconds of 100-kHz steady tone are played, followed by the message:

“The National Weather Service has issued a weather alert for this area; further information will be broadcast as it becomes available.”

B-2.1.3 **Orange-Force Protection Antiterrorism Threat.** Five seconds of fast whoop sound are played, followed by the message:

“Attention. A force protection antiterrorism threat has been issued for this area. Effective immediately, we are operating, ‘secure and lockdown procedures.’ All personnel should remain calm and stay where you are. Please wait for further instructions.”

B-2.1.4 **Green-All Clear.** Five seconds of chime sound are played, followed by the message:

“The emergency has now ended. Please resume normal operations. Thank you for your cooperation.”

B-2.2 **AIR FORCE: XXY Air Force Base**

B-2.2.1 **MESSAGE #1.** A 1-kHz tone is sounded for 5 seconds, followed by the message:

“May I have your attention, please. This is the command post with a test of the ____ Air Force Base mass notification system. Repeat, this is only a

test.”

B-2.2.2 **MESSAGE #2.** Five seconds of wail are played, followed by the message:

“Attention, attention. ____ Air Force Base is in Force Protection Condition Charlie. All personnel immediately implement FPCON Charlie actions.”

B-2.2.3 **MESSAGE #3.** Five seconds of wail are played, followed by the message:

“Attention, attention. ____ Air Force Base is in Force Protection Condition Delta. All personnel immediately implement FPCON Delta actions.”

B-2.2.4 **MESSAGE #4.** No alerting tone is used. The message played is:

“May I have your attention, please. All clear. The emergency has ended.”

B-2.2.5 **MESSAGE #5.** One round of code 3 horn is played, followed by the message:

“Your attention, please. ____ Air Force Base has issued a severe weather warning. Take required actions and tune into local radio or television for the latest update.”

B-2.2.6 **MESSAGE #6.** One round of code 3 temporal is played, followed by the message:

“Attention. A fire emergency has been reported. Please evacuate the building.”

B-2.3 **Air Force: XXZ Air Force Base.** Messages were pre-programmed for the MNS ACU and recorded in a male voice. All messages are repeated twice.

B-2.3.1 **Force Protection Condition Alert.** This message is labeled “FPCON ALERT.” A siren is played for 5 seconds (sound clip from manufacturer), followed by the message:

“Attention, attention. The Force Protection Condition for ____ AFB has been elevated. All personnel are to immediately implement prescribed actions. Tune your television to the Commander’s access channel or access the base intranet for further information.”

B-2.3.2 **Peacetime Emergency Warning.** This message is labeled “Peacetime emergency.” A horn sound is played for 5 seconds (sound clip from the manufacturer), followed by the message:

“Your attention, please. An emergency has been reported on _____ AFB. Immediately take shelter inside a facility. Remain in place and await further instructions.”

B-2.3.3 Severe Weather Warning. This message is labeled “Severe Weather.” A horn sound is played for 5 seconds (sound clip from the manufacturer), followed by the message:

“Your attention, please. A severe weather warning has been issued for _____ AFB. Take appropriate action and tune in to the local radio or television stations for the latest updates.”

B-2.3.4 Natural Disaster Warning. This message is labeled “Natural Disaster.” A horn sound is played for 5 seconds (sound clip from the manufacturer), followed by the message:

“Your attention, please. A natural disaster has either occurred or is expected shortly that will impact _____ AFB. Take appropriate action and tune in to the local radio or television stations for the latest updates.”

B-2.4 AIR FORCE: XYX Air Force Base. Messages were recorded in a male voice. The language used was English.

B-2.4.1 Three 1-kilohertz (kHz) tones (one second each) are played, followed by the message:

“Attention, attention. Implement Force Protection Condition Delta. Refer to _____ AFB intranet for current Battle Staff Directive.”

B-2.4.2 Three 1-kHz tones (one second each) are played, followed by the message:

“Attention, attention. Disaster control group recall. Report to primary rally point.”

B-2.4.3 Three 1-kHz tones (one second each) are played, followed by the message:

“Attention, attention. All personnel shelter in place.”

B-2.4.4 Three 1-kHz tones (one second each) are played, followed by the message:

“Attention, attention. Battle-staff recall. Key personnel report to command post.”

B-2.4.5 Three 1-kHz tones (one second each) are played, followed by the message:

“Attention, attention. Implement Force Protection Condition Charlie.”

Refer to ____ AFB intranet for current Battle Staff Directive.”

B-2.4.6 Three 1-kHz tones (one second each) are played, followed by the message:

“Attention, attention. Implement Force Protection Condition Bravo.
Refer to ____ AFB intranet for current Battle Staff Directive.”

B-2.4.7 Three 1-kHz tones (one second each) are played, followed by the message:

“Attention, attention. Implement Force Protection Condition Alpha.
Refer to ____ AFB intranet for current Battle Staff Directive.”

B-2.4.8 No alerting tone is used. Message played is:

“May I have your attention, please. The National Weather Service has issued a severe weather warning for our area.”

B-2.5 **AIR FORCE: XYY Air Force Base.** Messages were pre-programmed for the MNS ACU and recorded in a male voice. All messages were repeated twice.

B-2.5.1 **Force Protection Condition Alert.** This message is labeled “FPCON.” The button color used was red. A siren is played for 5 seconds (sound clip from manufacturer), followed by the message:

“Attention, attention. The Force Protection Condition for ____ AFB has been changed. All personnel are to immediately implement prescribed actions. Tune your television to the Commander’s access channel or access the base intranet for further information.”

B-2.5.2 **Bomb Threat Warning.** This message is labeled “BOMB.” The button color used was red. A horn sound is played for 5 seconds (sound clip from the manufacturer), followed by the message;

“Attention, attention. A bomb threat alert has been issued for this building. All personnel are to evacuate immediately using the nearest exit. Further instructions will be issued outside the building by emergency response teams.”

B-2.5.3 **Terrorist Threat Warning.** This message is labeled “TERRORIST.” The button color used was red. A horn sound is played for 5 seconds (sound clip from the manufacturer), followed by the message:

“May I have your attention, please. A terrorist threat has been received. Effective immediately, we are operating ‘secure and lockdown procedures.’ All personnel should remain calm and stay where you are. Please await further instructions.”

B-2.5.4 All Clear. This message is labeled “ALL CLEAR.” The button color used was blue. A horn sound is played for 5 seconds (sound clip from manufacturer), followed by the message:

“The building emergency has now ended. Please resume your normal duties. Thank you for your cooperation.”

APPENDIX C

NET-CENTRIC ALERTING SYSTEMS (NCAS)

C-1 **OVERVIEW.** This appendix provides information on on-going development of system requirements for alerting systems that will be based on IP technologies. This appendix is not mandatory but is provided to stimulate development of suitable requirements and standards for DOD installations. Consequently, user suggestions and feedback on this appendix are highly encouraged and requested. Methods to ensure reliability and robustness in off-normal or emergency conditions are of particular concern. The required amount of and method for isolating alerting functions from normal, non-alerting system functions needs development. The need for listing or approval by NRTLs is also an area of investigation.

C-2 **SUGGESTED CAPABILITIES OF A NCAS**

C-2.1 **Overview.** NCAS are enterprise-class systems for the management of and mass distribution of emergency notification messages within buildings, throughout installations, across entire geographical regions, or throughout a worldwide military command. Net-centric alerting may not be used in lieu of required audible alerting MNS but should be integrated with MNS whenever possible. Using NCAS, designated system operators would be able to rapidly and reliably inform appropriate personnel about anti-terrorism/force protection conditions (FPCON) (including chemical, biological, radiological, and nuclear threats), hazardous weather conditions, and many other critical events—possibly with near real-time response capability. NCAS leverages the IP network infrastructure to instantly reach those personnel who have access to nearly any IP-connected devices (such as pop-up alerts on personal computers (PC), text messages to personal data assistants (PDA) and cellular telephones, electronic mail to IP-capable cellular telephones, and recorded voice messages to voice-over-IP (VoIP) telephones and PCs). Additionally, NCAS could be used to activate, through a single interface, non-IP alerting systems such as giant voice outdoor warning systems and traditional dial-up telephone alerting systems.

NCAS would also enable the central management of the entire notification flow, including users' management, groups targeting, operators' permissions, access policies, pre-defined emergency scenarios, and response tracking and reporting. This capability would provide NCAS with the flexibility to comply with existing concept of operations (CONOPS) for emergency management (EM) and personnel notifications. NCAS could also monitor external sensors and third-party sources of emergency events, such as government-supplied weather information, and could be used to automatically initiate alerts based on pre-defined alerting scenarios.

C-2.2 **Installed Independently in each Facility or Centrally in a 24/7 Regional Operations Center (ROC).** NCAS would be installed independently in

each installation/facility (such as in the base network control center) or centrally in a 24/7 ROC that covers multiple geographically separated facilities and installations.

In a centrally managed NCAS configuration, personnel and facilities in the ROC's particular area of coverage could be alerted instantly by events either from any individual installation or centrally from the ROC. Using management tools, designated operators from each installation in the region could log in via a Web browser and have complete access to their own portion of the NCAS. The ROC would retain the ability to centrally monitor and manage all portions of the system.

C-2.3 Network Security Compliance. The NCAS would be installed behind the appropriate Internet system firewalls. It would be provided with net-centric architecture that fully supports DOD networking standards and security requirements. More specifically, the NCAS would use a Web-based user interface, support DOD standard network ports and protocols, and provide open interfaces to support interoperability such as Extensible Markup Language (XML)- and common access protocol (CAP)-based emergency messages. The system would include provisions for secure communications, authentication, and encryption using DOD and industry-standard encryption technologies. The system would be DOD Information Technology Security Certification and Accreditation Process/DOD Information Assurance Certification and Accreditation Process (DITSCAP/DIACAP) approved/certified, comply with DOD Computer Security Center Standard (CSC-STD) 002-85, and have a proven support for DOD Common Access Card (CAC) authentication.

C-2.4 General NCAS Functionality. The NCAS would be a COTS software product and use industry standards. The NCAS would have server-based architecture, allowing central alert activation, control, and management; such server(s) would be connected to the local network and integrated with the local user directory (i.e., support for Lightweight Directory Access Protocol (LDAP) and Active Directory integration is required).

C-2.4.1 Delivery Methods. The NCAS would be capable of sending alert messages to end-users (recipients) via multiple delivery methods, including:

- Audio-visual network alerts to desktops and laptops via desktop pop-up
- Text alerts to mobile phones and pagers
- Text alerts to electronic mail (e-mail) clients
- Audio alerts to phones
- Audio alerts to existing outdoor PA/giant voice systems

- Network alerts to any other IP-connected devices via standard XML and CAP protocols

The system would be extendable to support additional delivery methods in the future as this technology develops.

C-2.4.2 Targeted Recipients. The NCAS would be capable of sending alert messages to target recipients according to:

- Hierarchical organizational structure (as would be imported from an LDAP or Active Directory)
- Organizational roles
- Specific distribution lists (e.g., hazardous materials (HAZMAT) response teams)
- Dynamic groups created through on-the-fly queries of the user directory
- Geographical locations (e.g., entire bases, zones within bases)
- IP addresses (required for targeting devices in specific physical locations)

C-2.4.3 Tracking and Reporting Functions. The NCAS would be able to centrally track, in real-time, all alerting activities for each individual recipient, including sending, receiving, and responding to alerts, and be able to generate reports based on tracked information.

C-2.4.4 Signal and Message Library. The NCAS would incorporate a pre-defined library of signals and messaging appropriate to:

- FPCONs
- Terrorism threats, watches, or warnings
- Evacuation routes
- Battle staff directives
- Personnel recall requirements
- Federal, DOD, or installation-specific warning and notification requirements

The NCAS would provide means for monitoring and integrating with external event sources, and activating alerts automatically based on identifying a match with pre-defined conditions.

C-2.4.5 Web-based Management. The NCAS would incorporate a Web-based management and alert activation application through which all operators and administrators could gain access to the system's capabilities based on the users' permissions and the defined access policy. Such a management application would incorporate management of the alert activation flow through all delivery methods, as well as end-user management, operators' permission and access, tracking and reporting, and all administrative aspects of the system.

C-2.5 Interoperability. The NCAS would be able to interface and interoperate with UFC 4-021-01-compliant mass notification capabilities, including wide area MNS, individual building MNS, giant voice outdoor warning systems, and telephony alerting systems. During emergencies, systems operators should not need to send notifications using multiple alerting systems. The NCAS would provide the capability to integrate user interfaces and consolidate access to multiple mass notification and alerting systems.

C-2.6 Monitoring and Automating Emergency Alerts Flow. The NCAS would be capable of monitoring emergency notifications from multiple data sources (National Weather Service, Emergency Managers Weather Information Network (EMWIN), meteorology and oceanography (METOC), and others) and automatically sending out notifications to designated facilities and personnel based on pre-defined rules.

C-2.7 Back-up NCAS Systems. The NCAS would support multiple server configurations to achieve a "hot standby" failover configuration (i.e., no down time in case of failure in a single server) as well as to support higher load scenarios (e.g., more users).