

Eclipse Single-Ended Ceramic Radiant Tube Burners

Model SER 600

Data sheet Edition 7.16

Version 5

Parameter	Typical Burner Input 1000's Btu/h (kW)		
	50 (13)	100 (26)	200 (52) ¹
Low Firing Rate x 1000 Btu/h (kW)² <i>Between 150 - 220% excess air</i>	10 (3.0)	10 (3.0)	10 (3.0)
Air Inlet Pressure, "w.c. (mbar) <i>15% excess air at maximum input Tap A (see page 4) based on 1700°F (927°C) chamber temperature</i>	7.0 (17.4)	11.0 (27.4)	24.2 (60.2)
Air flow, SCFH (Nm³/h) <i>At 15% excess air</i>	560 (15.0)	1120 (30.0)	2240 (60.0)
Main Gas Inlet Pressure, "w.c. (mbar)³ <i>Tap B (see page 4)</i>	5.0 (12.4)	6.5 (16.2)	13.4 (33.4)
Maximum Chamber Temperature, °F (°C) <i>Refer to page 3 for maximum heat flux. Contact Eclipse for temperatures above 1750°F (954°C)</i>	1850 (1010)		
Piping	NPT or BSP interface is available		
Flame Detection	UV Scanner		
Ignition	Direct Spark Ignition (6 kVAC)		
Fuel⁴ <i>For any other mixed gas, contact Eclipse, Inc.</i>	Natural Gas		
Weight, lbs (kg)⁵ <i>Burner length "M" (less mounting extension, inner and outer tubes)</i>	55 (25.1)		
Approvals			

- 1.) Refer to the Burner Sizing section of Design Guide 325 for the maximum firing rate for a given tube configuration and furnace temperature.
- 2.) The low fire rate represents the capability of the burner. Achievement of this rate will be affected by the control method and ratio regulator used in the system design. Typical ratio regulators provide a 10 to 1 turndown from high to low fire.
- 3.) If a ratio regulator is being used, the gas pressure into the ratio regulator should be at least 5" w.c. (12.5 mbar) above the static air pressure at Tap A.
- 4.) See Design Guide 325 for more information about typical fuel composition and properties.
- 5.) All weights are approximate.
 - All imperial inputs based upon gross calorific values (HHV). All metric inputs based upon net calorific values (LHV).
 - All information is based on laboratory testing with neutral (0.0" w.c.) exhaust conditions.
 - All inputs based upon standard conditions: 1 atmosphere, 70°F (21°C).
 - Air and fuel pressure data given in this document are based on 15% excess air and hot furnace conditions.
 - Plumbing of air and gas will affect accuracy of orifice readings. All information is based on generally acceptable air and gas piping practices.
 - Eclipse reserves the right to change the construction and/or configuration of our products at any time without being obliged to adjust earlier supplies accordingly.

Performance Graphs

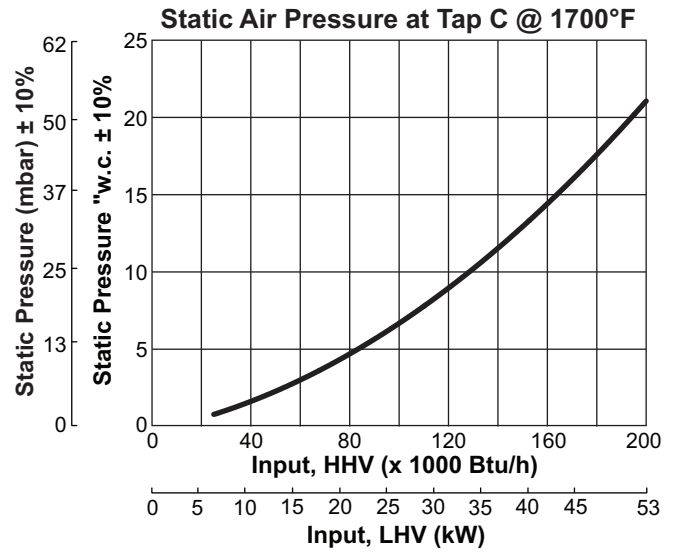
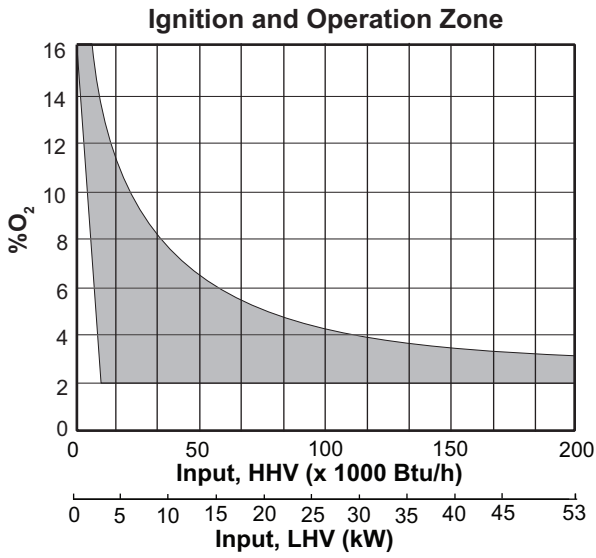

- Static pressure will increase with temperature
- Air supply pressure required at the burner inlet (tap A) is static pressure at Tap C plus the pressure drop across Tap A to Tap C

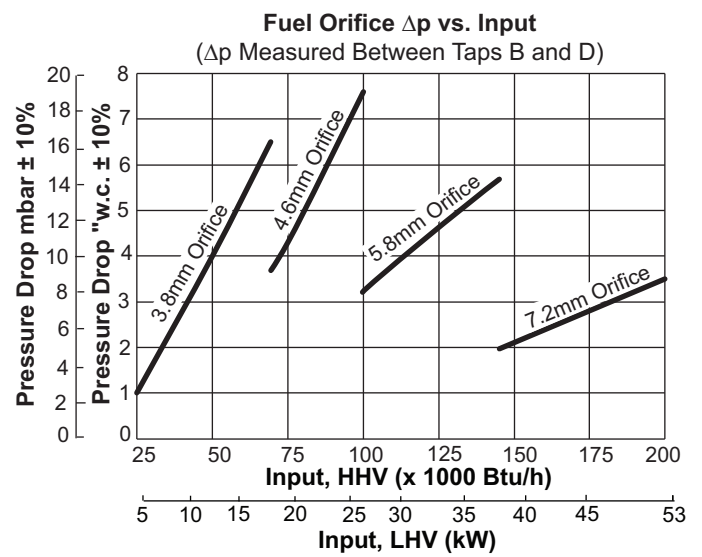
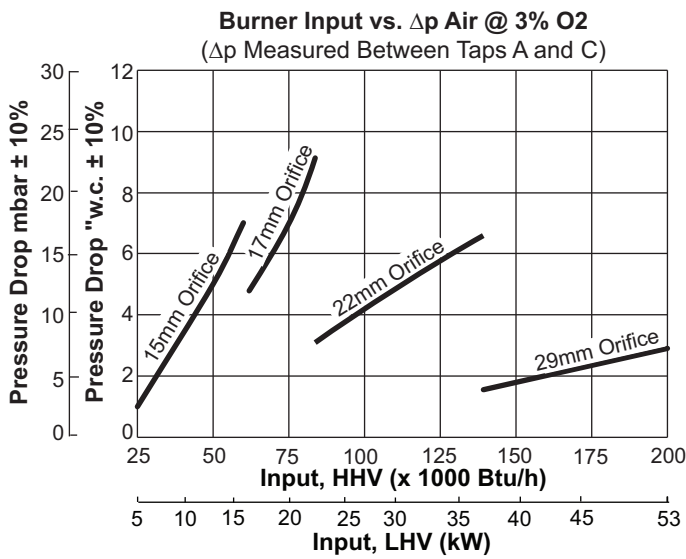

Efficiency Graphs

SER600 Efficiency with 50 Btu/sqinch/h heat flux

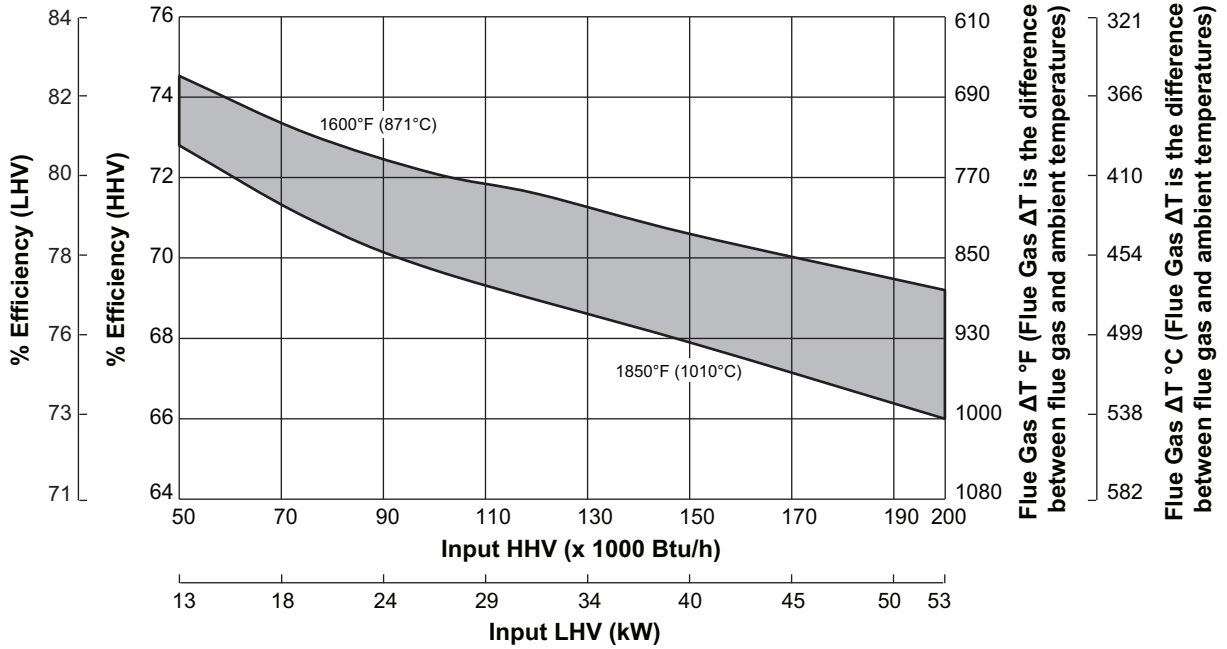

SER600 Efficiency with 100 Btu/sqinch/h heat flux

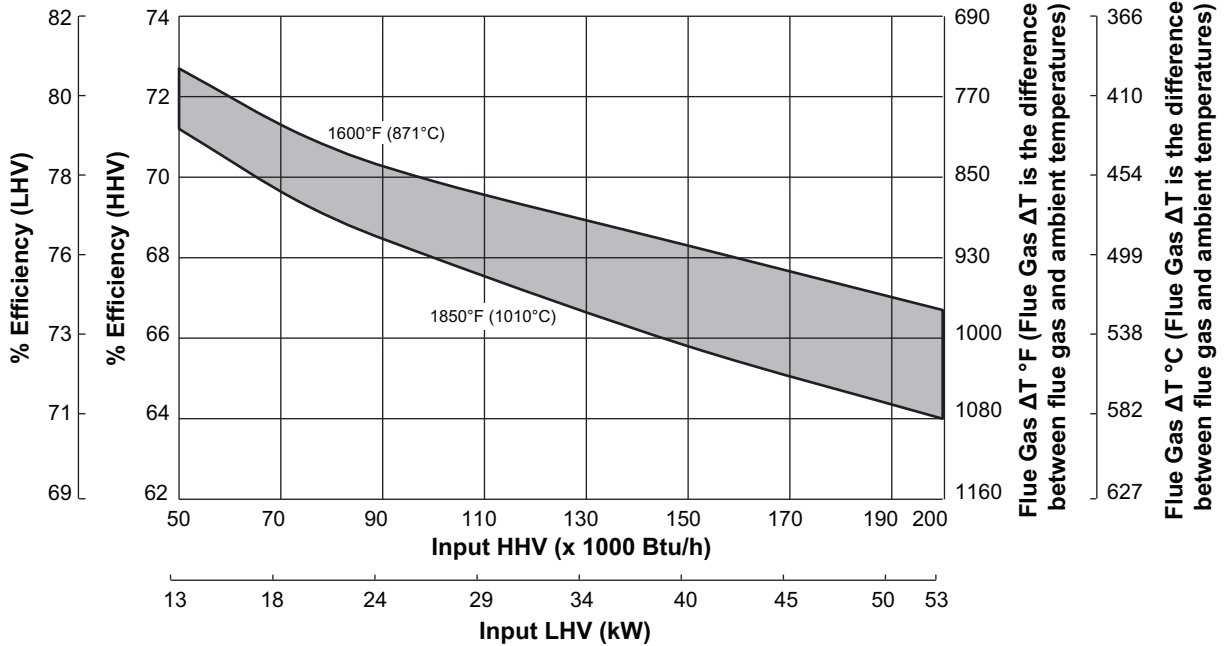

Horizontally Mounted Burner Dimensions and Specifications

Dimensions in mm (inches)

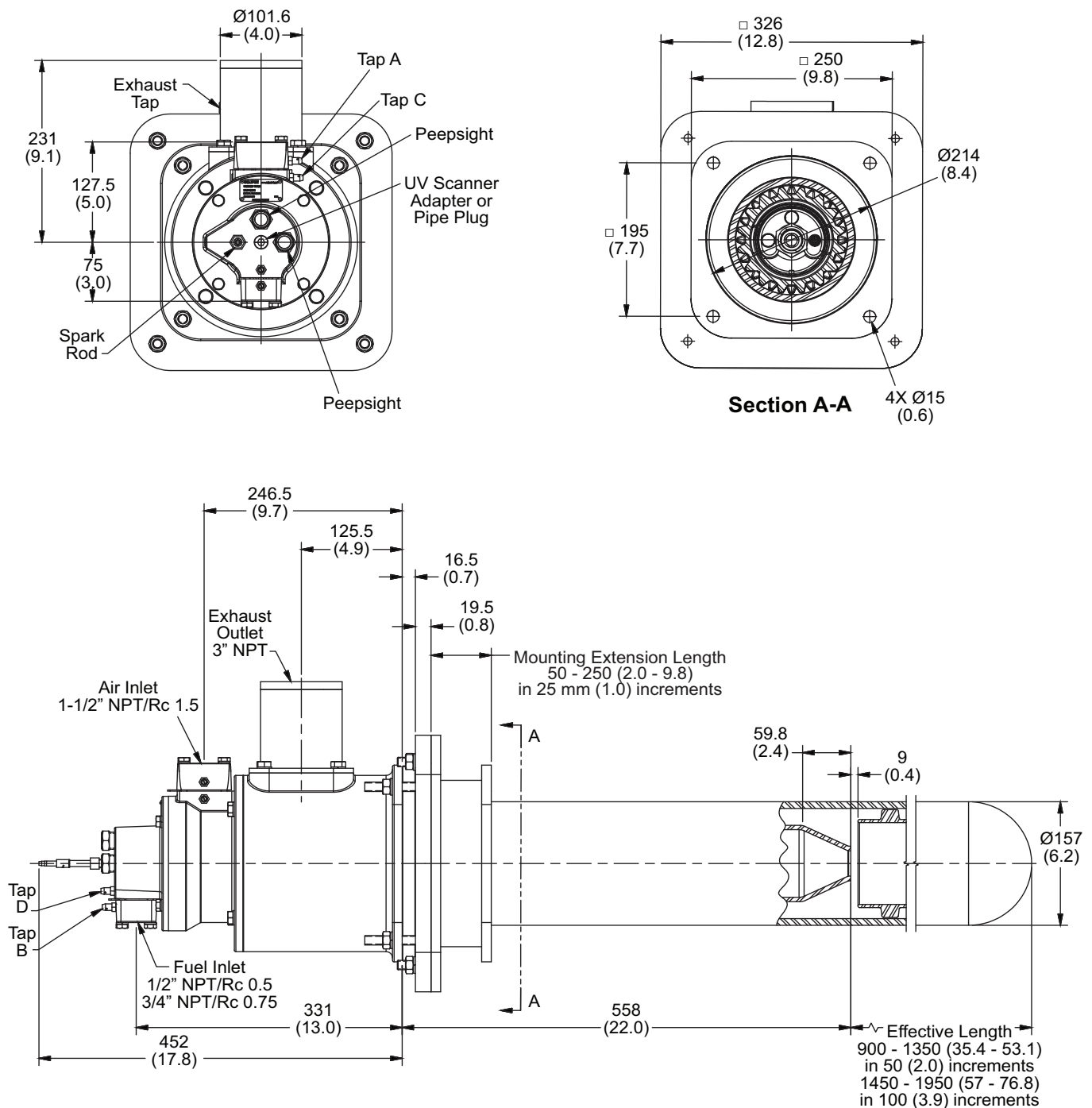

Vertically Mounted Burner

Dimensions and Specifications

Dimensions in mm (inches)

