

# Eclipse Vortometric

## Burners

### Series MI Air Cooled Combustor

Version 4

Parameter	Burner Model											
	6V	8V	10V	12V	14V	16V	18V	22V	24V	28V	32V	36V
<b>Max Input MMBTU/hr (MW)</b>	6.0 (1.8)	10.5 (3.1)	17.0 (5.0)	23.0 (6.7)	32.0 (9.4)	42.0 (12.0)	55.0 (16.1)	78.0 (23.0)	90.0 (26.0)	125.0 (37.0)	160.0 (47.0)	210.0 (62.0)
<b>Min Input MMBTU/hr (MW)</b>	0.3 (0.1)	0.5 (0.1)	0.8 (0.2)	1.0 (0.3)	1.3 (0.4)	1.5 (0.4)	2.0 (0.6)	2.7 (0.8)	3.0 (0.9)	5.0 (1.5)	6.0 (1.8)	7.0 (2.1)
<b>Gas Inlet Pressure Required, "w.c. (mbar) <sup>1</sup></b>	24 (59)	24 (59)	24 (59)	24 (59)	24 (59)	24 (59)	45 (112)	45 (112)	45 (112)	45 (112)	45 (112)	45 (112)
<b>Air Inlet Pressure Required, "w.c. (mbar) <sup>2</sup></b>	6.0 (15)	7.5 (19)	7.5 (19)	7.5 (19)	7.5 (19)	7.5 (19)	7.5 (19)	7.5 (19)	7.5 (19)	7.5 (19)	7.5 (19)	7.5 (19)
<b>Total Air Flow, scfm (m<sup>3</sup>/min) <sup>2</sup></b>	1352 (38)	2367 (67)	3832 (108)	5184 (147)	7213 (204)	9467 (268)	12397 (351)	17581 (498)	20286 (574)	28175 (798)	36064 (1021)	47334 (1340)
<b>Natural Gas Flow scfh x 1000 (m<sup>3</sup>/hr) <sup>1</sup></b>	6.0 (169)	10.5 (296)	17.0 (479)	23.0 (649)	32.0 (903)	42.0 (1185)	55.0 (1551)	78.0 (2200)	90.0 (2538)	125.0 (3526)	160.0 (4513)	210.0 (5923)
<b>Combustion Air Temp., °F (°C) <sup>3</sup></b>	< 500 (260)											
<b>Process Temperature, °F (°C)</b>	< 1,600 (870)											
<b>High Fire Flame Length, Feet (m) <sup>4</sup></b>	6 (1.8)	7 (2.1)	8 (2.4)	9 (2.7)	10.5 (3.2)	12 (3.7)	13 (4.0)	15 (4.6)	16 (4.9)	18 (5.5)	20 (6.1)	24 (7.3)
<b>High Fire Flame Diameter, Inches (m)</b>	28 (0.7)	30 (0.8)	34 (0.9)	38 (1.0)	42 (1.1)	46 (1.2)	50 (1.3)	56 (1.4)	60 (1.5)	70 (1.8)	76 (1.9)	84 (2.1)
<b>Flame Detection</b>	UV or IR (flicker type) scanner											
<b>Fuels</b>	Main Burner	Natural gas, propane, butane, manufactured and other mixed gases										
	Pilot	Natural gas and propane <sup>5</sup>										
<b>Approvals</b>												

- Natural gas capacities are based on gross heating value (1,000 BTU/scf, 0.6 specific gravity)
- Combustion air flows and pressure drops at 15% excess air at standard conditions (70°F, 14.7 psia)
- Contact Eclipse for burner sizing and recommendations for preheated air over 300°F (150°C)
- Flame lengths provided are estimates based on general operating conditions and are useful for design purposes. Actual flame lengths will depend on chamber size and presence of secondary air.
- See Design Guide 128 for more information about typical fuel composition and properties.
  - Burner minimum inputs stated for modulating combustion air.
  - Air and natural gas pressure drops should be taken as a differential pressure between the air/gas at the burner and the chamber pressure.
  - Eclipse reserves the right to change the construction and/or configuration of our products at any time without being obligated to adjust earlier supplies accordingly.

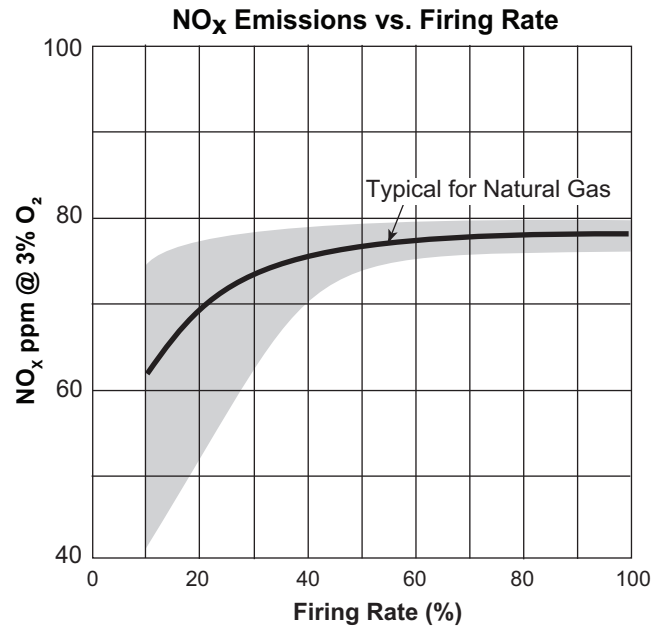
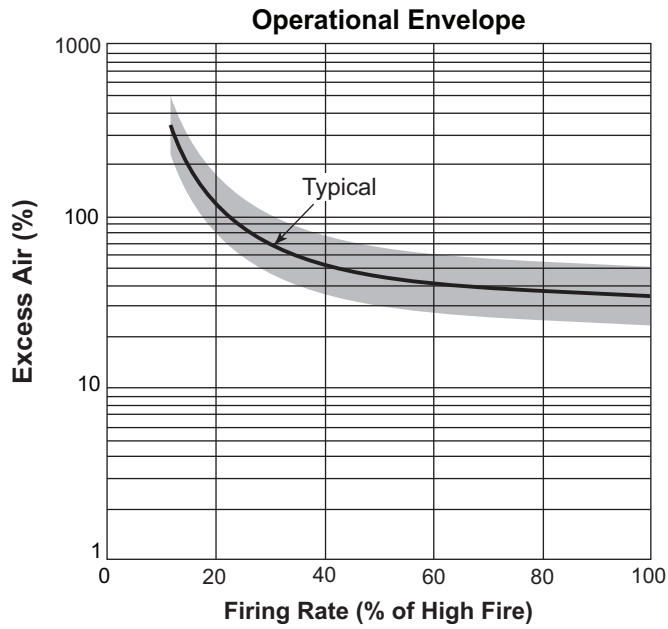

Burner emissions depend on and are affected by operational and applicational conditions. Contact Eclipse for specific emissions estimates for your application.

### Combustion Air Pressure Drop vs. Burner Heat Input for Medium Intensity Burners (MI)

Operation with 15% excess air on natural gas under standard conditions, 14.7 psia, 70°F (1013 mbar, 21°C)  
 Pressure drop should be taken between the chamber and windbox pressure tap (tap A)

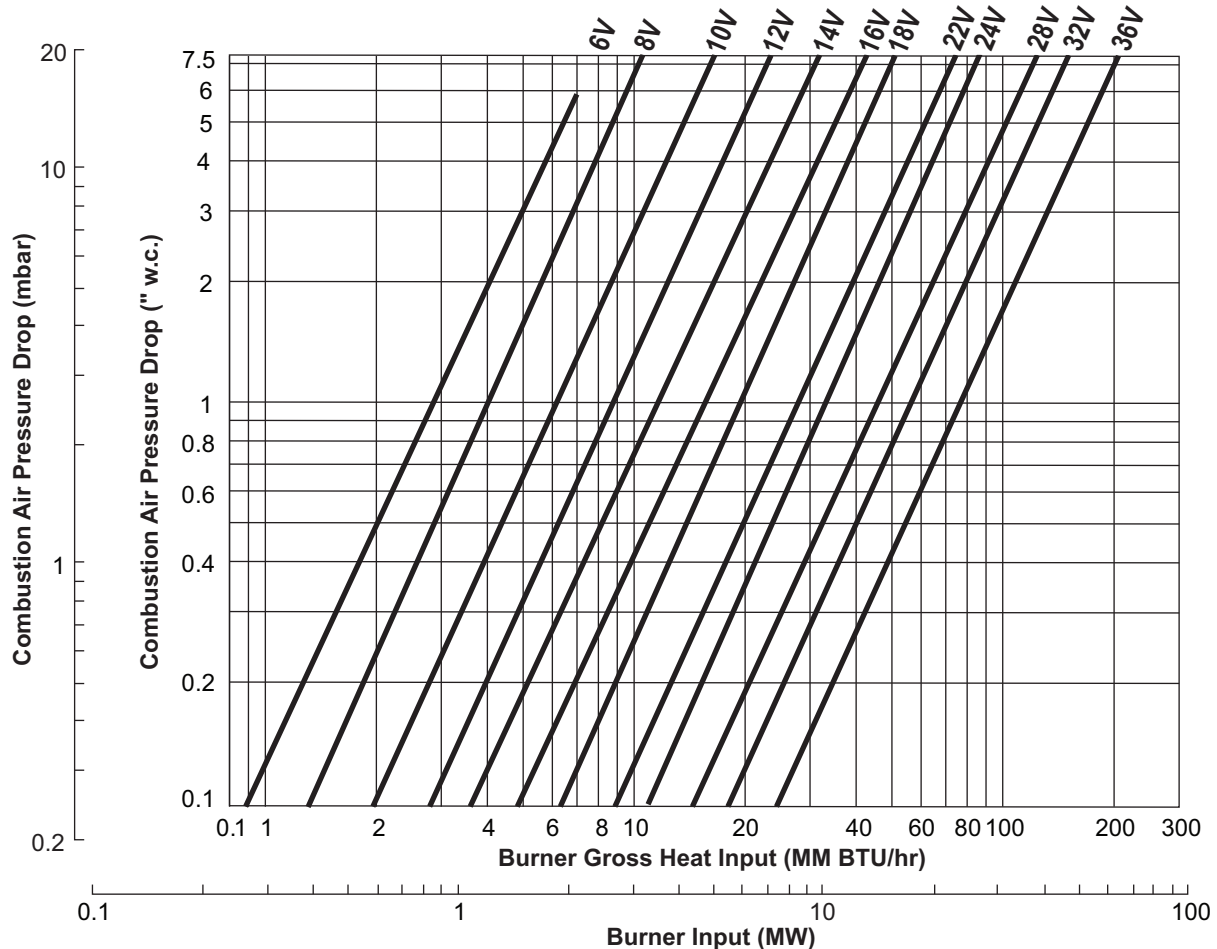

### Gas Lance Pressure Drop vs. Burner Heat Input

Pressure drops for natural gas, 1,000 BTU/scf gross (0.29 kW/m<sup>2</sup>), 0.6 specific gravity. Pressure drop should be taken as differential between the chamber and gas lance pressure tap (tap B).

**NOTE:** Fuel pressure drop curves should be used as a guide for setting up burner. It is recommended to use a direct fuel flow measurement (orifice plate or flow meter) for determining actual fuel flows.

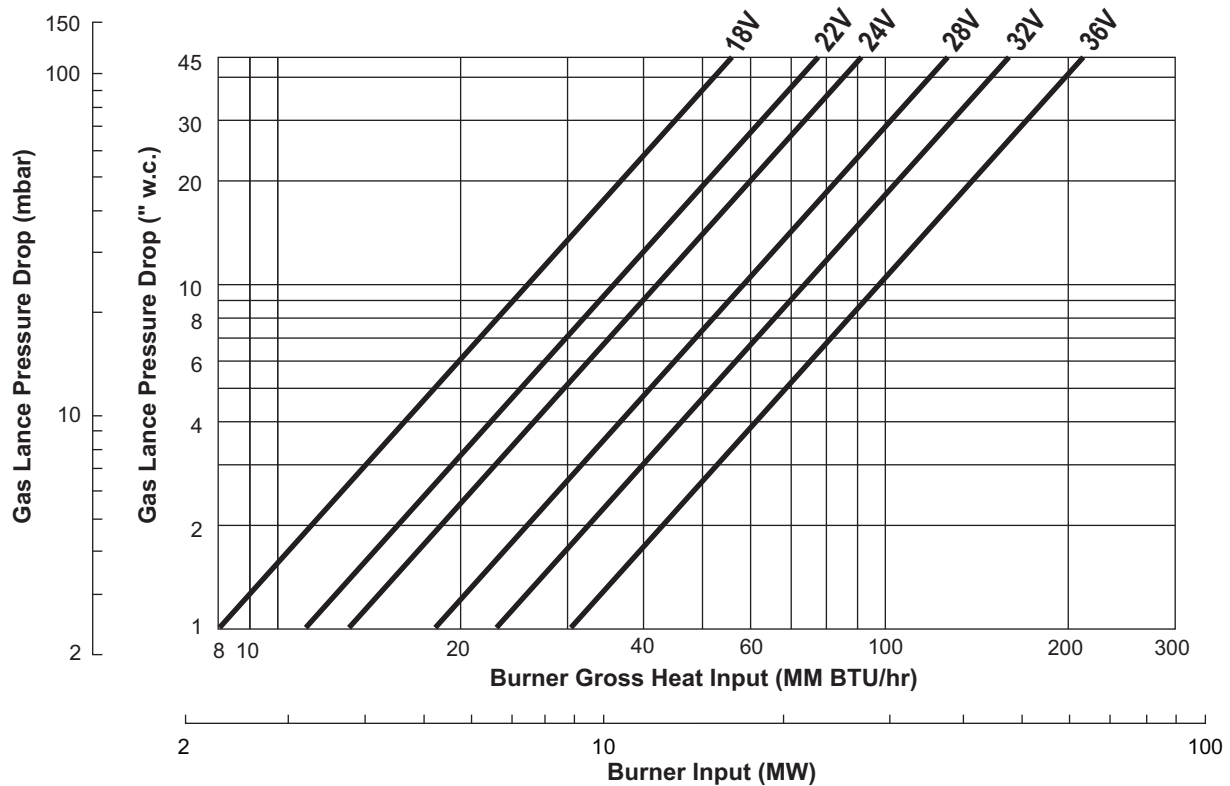
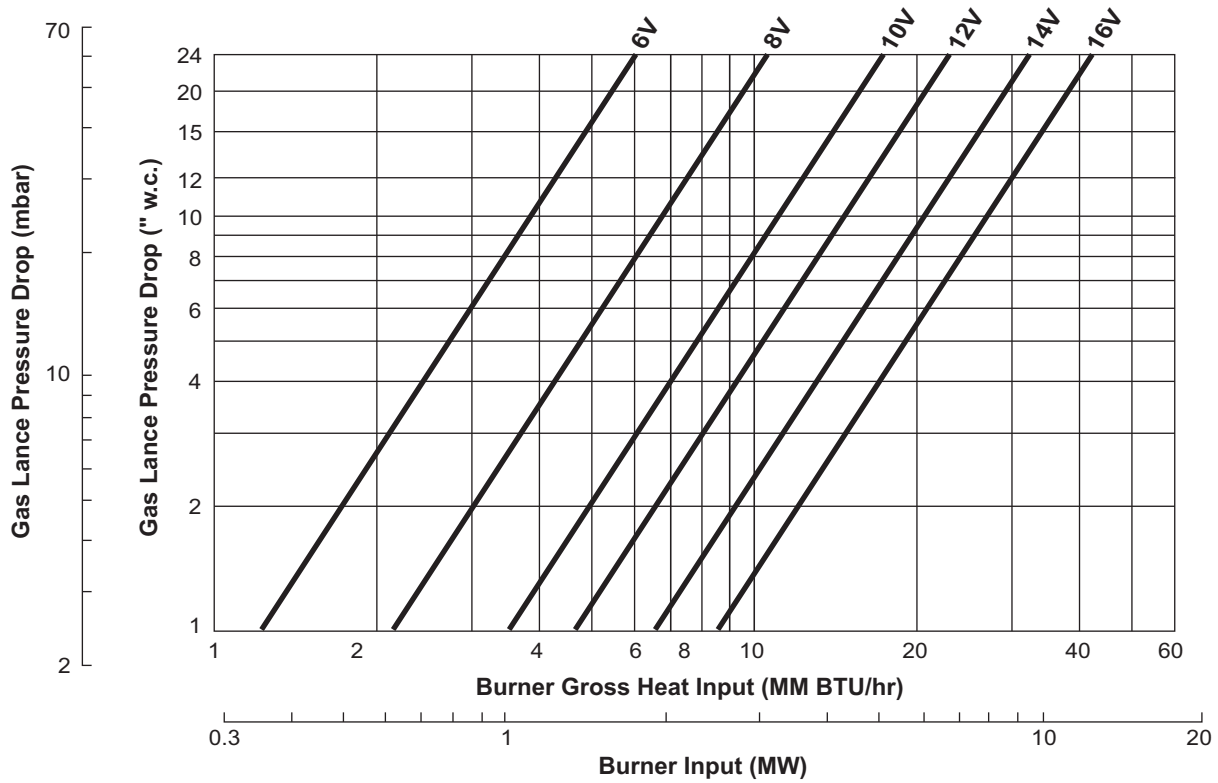

## Dimensions

Ref	Burner Size											
	6V	8V	10V	12V	14V	16V	18V	22V	24V	28V	32V	36V
<b>A</b>	2	2-1/2	3	3	3	4 (DIN100)	4 (DIN100)	4 (DIN100)	6 (DIN150)	6 (DIN150)	6 (DIN150)	8 (DIN200)
<b>D</b>	3/4	3/4	3/4	3/4	3/4	3/4	3/4	1-1/4	1-1/4	1-1/4	1-1/4	1-1/4
<b>F</b>	4-1/8 (105)	4 (102)	4-3/4 (121)	6 (152)	8-3/4 (223)	9-15/16 (252)	12-1/2 (318)	16-1/8 (410)	17 (432)	21-3/8 (543)	24-1/4 (616)	28 (711)
<b>K</b>	6 (152)	6 (152)	6 (152)	6 (152)	6 (152)	6 (152)	6 (152)	6 (152)	6 (152)	6 (152)	6 (152)	6 (152)
<b>L</b>	9-1/4 (235)	11-1/2 (295)	12-3/4 (324)	12 (306)	13-1/2 (343)	14 (356)	14-1/2 (368)	15-1/4 (387)	15 (382)	16-3/4 (427)	15-7/8 (403)	21 (533)
<b>N</b>	25 (635)	25 (635)	28 (711)	31 (787)	34-1/2 (876)	37 (940)	41 (1041)	45-1/2 (1156)	50 (1270)	56-5/8 (1438)	59-3/16 (1503)	64-1/8 (1629)
<b>P</b>	12	12	12	12	12	12	12	12	16	16	16	24
<b>R</b>	11/16 (17)	11/16 (17)	11/16 (17)	11/16 (17)	11/16 (17)	11/16 (17)	11/16 (17)	11/16 (17)	11/16 (17)	11/16 (17)	11/16 (17)	11/16 (17)
<b>S</b>	16 (406)	16 (406)	17-1/2 (445)	19 (483)	20-1/2 (521)	22-1/2 (572)	24-1/2 (622)	27-1/2 (699)	30 (762)	32 (813)	35 (889)	38 (965)
<b>T</b>	9 (228)	9 (229)	12 (305)	15 (381)	18 (457)	21 (533)	24-1/2 (622)	30 (762)	33 (838)	38-1/2 (978)	45 (1143)	51-1/2 (1308)
<b>U</b>	21 (533)	21 (533)	21 (533)	23 (584)	26-3/8 (670)	28 (711)	30 (762)	34-3/8 (873)	37 (940)	41 (1041)	59 (1499)	64 (1626)
<b>V</b>	1	1	2	2	3	3	4	6	6	8	9	11
<b>W</b>	10-3/4 (273)	10-3/4 (273)	13-3/4 (348)	16-3/4 (425)	20-1/4 (514)	23-1/4 (591)	26-3/4 (679)	32-3/4 (832)	35-3/4 (908)	41-1/4 (1048)	47-3/4 (1213)	54-1/4 (1378)
<b>X</b>	4	4	4	5	6	5	6	8	7	8	13	15
<b>Y</b>	22-3/4 (578)	20-1/4 (514)	22-3/4 (577)	24-3/4 (628)	28-5/8 (726)	30-1/4 (768)	32-1/4 (819)	37-1/8 (943)	39-3/4 (1010)	43-3/4 (1111)	61-3/4 (1568)	66-3/4 (1695)
<b>Z</b>	24 (610)	24 (610)	24 (610)	26 (660)	30-3/8 (772)	32 (813)	34 (864)	39-3/8 (1000)	42 (1067)	46 (1168)	64 (1626)	69 (1753)
<b>AA</b>	7/16 (11)	7/16 (11)	7/16 (11)	7/16 (11)	7/16 (11)	7/16 (11)	7/16 (11)	9/16 (14)	9/16 (14)	9/16 (14)	9/16 (14)	9/16 (14)
<b>BB</b>	12 (305)	12 (305)	15 (381)	18 (457)	22 (559)	25 (635)	28-1/2 (724)	35 (889)	38 (965)	43-1/2 (1105)	50 (1270)	56-1/2 (1435)
<b>CC</b>	17-5/8 (447)	17-5/8 (447)	19-15/16 (506)	24-1/8 (613)	28-7/8 (734)	32-5/8 (828)	38 (965)	45-7/8 (1165)	49-1/2 (1257)	59-1/8 (1501)	66-1/2 (1689)	76 (1930)
<b>EE</b>	30 (762)	30 (762)	33 (838)	36 (914)	39-1/2 (1003)	42 (1067)	46 (1168)	50-1/2 (1283)	56 (1422)	60-1/2 (1537)	65 (1651)	70 (1778)
<b>FF</b>	27-1/2 (699)	27-1/2 (699)	30-1/2 (775)	33-1/2 (851)	37 (940)	39-1/2 (1003)	43-1/2 (1105)	48 (1219)	53 (1346)	57-1/2 (1461)	62 (1575)	67 (1702)
<b>GG</b>	20-3/8 (518)	20-3/8 (518)	22-3/8 (568)	24-7/8 (631)	27-3/8 (695)	29-15/16 (760)	33-1/2 (851)	38-7/8 (987)	40-3/8 (1026)	44-7/8 (1140)	48-3/8 (1229)	53-3/8 (1356)
<b>HH</b>	18-7/16 (468)	18-7/16 (468)	20-7/16 (519)	22-1/4 (565)	24-13/16 (630)	28-11/16 (713)	31-3/4 (806)	35-1/2 (902)	38-11/16 (983)	43-3/16 (1097)	46-7/16 (1180)	51-5/16 (1304)
<b>JJ</b>	11 (279)	11 (279)	13 (330)	15-1/8 (384)	18 (457)	20-1/2 (521)	23 (584)	27-1/2 (699)	30 (762)	34 (864)	38 (965)	43 (1092)
<b>KK</b>	11 (279)	11 (279)	13-1/2 (343)	15 (381)	17-13/16 (452)	19 (483)	21-1/2 (546)	25-1/8 (639)	26 (660)	30-3/8 (772)	33-1/4 (845)	36-3/4 (933)
<b>LL</b>	6 (152)	8 (203)	10 (254)	12 (305)	14 (356)	16 (406)	18 (457)	22 (559)	24 (610)	28 (711)	32 (813)	36 (914)
<b>MM</b>	18	18	20	22	26	24	28	36	34	40	52	60
<b>NN</b>	3 (81)	5 (129)	5 (129)	5.75 (147)	5.75 (147)	10 (254)	10 (254)	10 (254)	11 (280)	12 (305)	12 (305)	14 (356)

## Dimensions

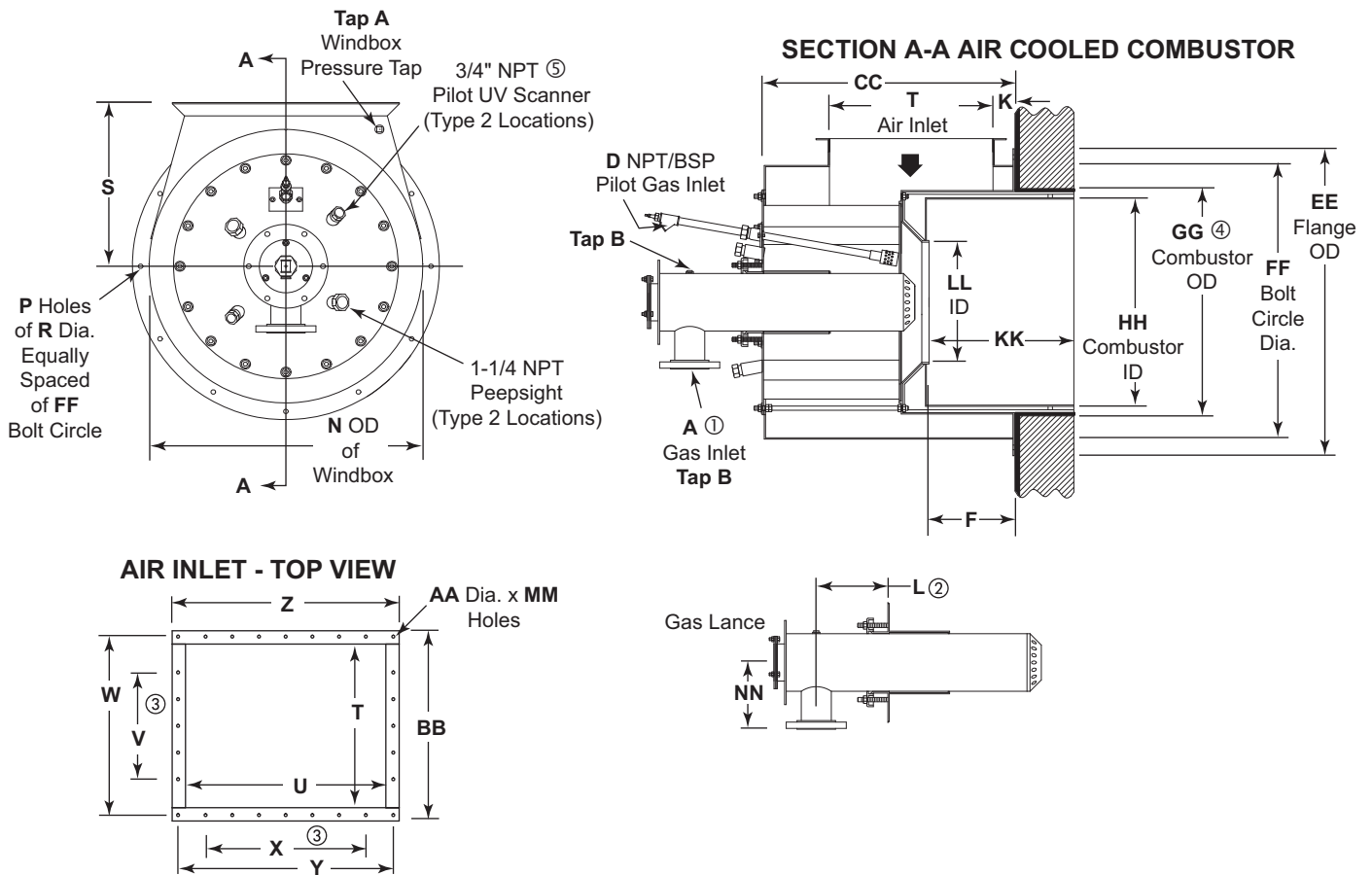

- Burner size 8V through 14V are NPT or BSP threaded; all other sizes are ANSI, RF, or DIN 150 lbs flanged.
- These dimensions can vary  $\pm 1.5"$  (38 mm) since gas lance position is adjustable.
- Indicates number of spaces, 4" (102 mm) apart.
- Ensure that furnace wall inside diameter is 1" (25 mm) greater than GG. See Section 3 of Installation Guide 128.
- An ultraviolet flame sensing device (UV scanner) may be mounted to two locations. Two scanner mounting ports (3/4" NPT) are located near the gas assembly adjacent to the pilot. The pilot scanner location can be used to prove both the pilot and the main flame.

## Pilot Capacities

Burner Size	Input BTU/hr (kW)	
	Main Burner	Pilot
6V	6,000,000 (1,757)	60,000 (17.6)
8V	10,500,000 (3,075)	105,000 (30.7)
10V	17,000,000 (4,978)	170,000 (49.8)
12V	23,000,000 (6,735)	230,000 (67.3)
14V	32,000,000 (9,370)	320,000 (93.7)
16V	42,000,000 (12,298)	420,000 (123.0)
18V	55,000,000 (16,105)	550,000 (161.0)
22V	78,000,000 (22,839)	780,000 (228.4)
24V	90,000,000 (26,353)	900,000 (263.5)
28V	125,000,000 (36,601)	1,250,000 (366.0)
32V	160,000,000 (46,850)	1,600,000 (468.5)
36V	210,000,000 (61,490)	2,100,000 (614.9)

## Burner Weights

Burner Size	Air Cooled lbs (kg)	Refractory lbs (kg)
6V	346 (157)	686 (311)
8V	370 (168)	701 (318)
10V	448 (203)	893 (405)
12V	567 (257)	1116 (506)
14V	688 (312)	1406 (638)
16V	847 (384)	1695 (769)
18V	1038 (471)	2125 (964)
22V	1420 (644)	2762 (1253)
24V	1755 (796)	3554 (1612)
28V	2220 (1007)	4685 (2125)
32V	2640 (1197)	5406 (2452)
36V	3460 (1569)	6890 (3125)