

34425501

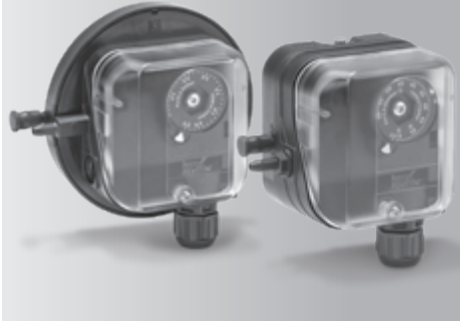

Operating instructions

Pressure switches for air DL..A, DL..K



Cert. version 05.18

Safety

Please read and keep in a safe place



Please read through these instructions carefully before installing or operating. Following the installation, pass the instructions on to the operator. This unit must be installed and commissioned in accordance with the regulations and standards in force. These instructions can also be found at www.docuthek.com.

Explanation of symbols

- , **1**, **2**, **3**... = Action
- ▷ = Instruction

Liability

We will not be held liable for damage resulting from non-observance of the instructions and non-compliant use.

Safety instructions

Information that is relevant for safety is indicated in the instructions as follows:

⚠ DANGER

Indicates potentially fatal situations.

⚠ WARNING

Indicates possible danger to life and limb.

! CAUTION

Indicates possible material damage.

All interventions may only be carried out by qualified gas technicians. Electrical interventions may only be carried out by qualified electricians.

Conversion, spare parts

All technical changes are prohibited. Only use OEM spare parts.

Changes to edition 05.18

The following chapters have been changed:

- Checking the usage
- Installation
- Accessories
- Technical data
- Certification

Checking the usage

DL 1,5–3A, DL 3K, DL 5–150A, DL 5–150K

For monitoring positive, negative or differential pressures of air, flue gas or other non-aggressive gases. This function is only guaranteed when used within the specified limits – see page 5 (Technical data). Any other use is considered as non-compliant.

Type code

Code	Description
DL	Pressure switch for air
1,5 – 150	Max. setting in mbar
K	With tube connection and hand wheel
A	Additionally with Rp ¼ connection (optional: Rp ½)
T	T-product
G	Gold contacts
	Electrical connection
-2	via screw terminals, ½" NPT
-3	via screw terminals
-4	via screw terminals, IP 65
-5	4-pin plug, without socket
-6	4-pin plug, with socket
-9	4-pin plug, with socket, IP 65
K2	Red/green pilot LED for 24 V DC/AC
T	Blue pilot lamp for 230 V AC
T2	Red/green pilot LED for 230 V AC
N	Blue pilot lamp for 120 V AC
P	With test tapping point
1	With 1 test key (lower chamber +)
2	With 2 test keys (upper chamber -, lower chamber +)
A	External adjustment
W	Z-angle bracket

Part designations

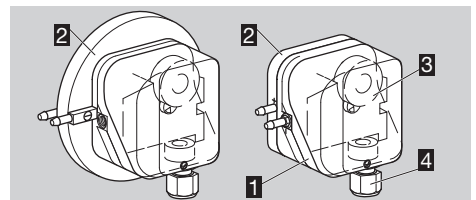

- 1** Upper housing section with cover
- 2** Lower housing section
- 3** Hand wheel
- 4** M16 cable gland

Type label

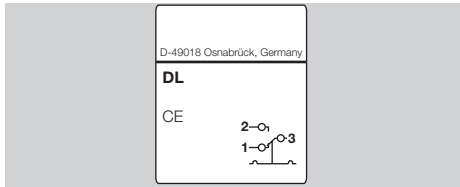

Max. inlet pressure = withstand pressure, mains voltage, ambient temperature, enclosure: see type label.

Installation

! CAUTION

Please observe the following to ensure that the DL is not damaged during installation and operation:

- Dropping the device can cause permanent damage. In this event, replace the entire device and associated modules before use.
- Use approved sealing material only.
- Note the max. medium and ambient temperatures, see page 5 (Technical data).
- Condensation must not be allowed to get into the housing (if possible, install pipework with an ascending gradient). Otherwise, there is a risk of icing of condensation at subzero temperatures, the switching point shifting or corrosion in the device which can lead to malfunctions.
- Protect the connections against dirt or moisture in the medium to be measured or the surrounding air. If necessary, install a filter.
- In case of highly fluctuating pressures, install a damping nozzle/restrictor orifice.
- When installing outdoors, place the DL in a roofed area and protect from direct sunlight (even IP 65 version). To avoid condensation, the cover with pressure equalization element can be used on some types.
- In the case of an uneven mounting surface, secure the pressure switch to the mounting plate or air duct with only two screws on the same side in order to avoid subjecting the pressure switch to mechanical stress.
- When using silicone tubes, only use silicone tubes which have been sufficiently cured. Vapours containing silicone can adversely affect the functioning of electrical contacts.
- In the case of high humidity, we recommend using a pressure switch with gold contact due to its higher resistance to corrosion. Closed-circuit current monitoring is recommended under difficult operating conditions.

- ▷ Ensure that there is sufficient installation space.
- ▷ Ensure unobstructed view of the hand wheel.

- ▷ Installation in the vertical or horizontal position, or upside down, preferably with vertical diaphragm. If installed in a vertical position, the switching point p_S will correspond to the scale value SK.

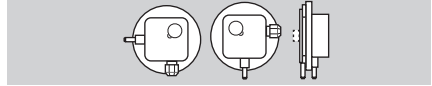

- ▷ If installed in another position, the switching point p_S will change and no longer correspond to the set scale value SK. Switching point p_S must be checked.

	SK + 0.18 mbar [+ 0.071 "WC]	SK - 0.18 mbar [- 0.071 "WC]
DL 1,5A	 e.g. SK = -0.5: $p_S = -0.5 + 0.18$ $p_S = -0.32$ mbar	
DL 3K, DL 3A		
DL 5-150A, DL 5-150K		

- ▷ For 1 mm thick mounting plates, use self-tapping screws for plastic:

DL..A, DL 3K: \varnothing 3.5 x 8 mm or \varnothing 4 x 8 mm.
DL 5-150K: \varnothing 3.5 x 16 mm.

- 1 Fit the DL.

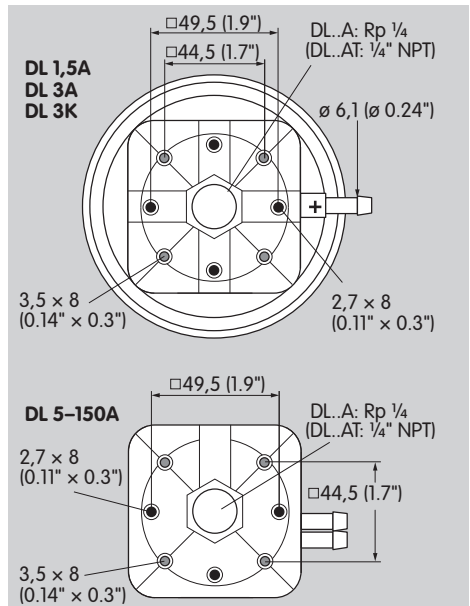

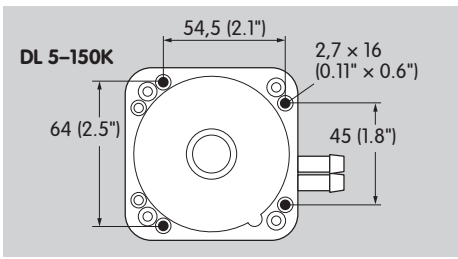

- 2** Connect the pressure line.
- DL..A: upon delivery, port 2 is closed off by a rubber cap.

DL 1,5A, DL 3A

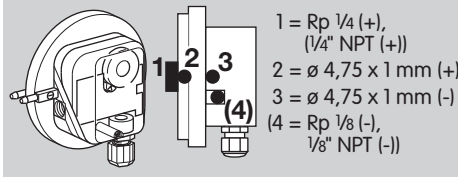

- Positive pressure: port 1 or 2
- Negative pressure: port 3
- Special version DL 3A-3Z: port 4

DL 5-150A

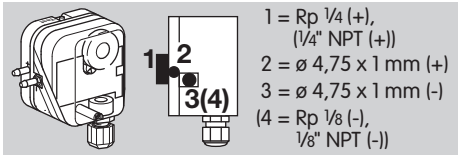

- Positive pressure: port 1 or 2
- Negative pressure: port 3; after unscrewing port 3 also port 4

DL 3K

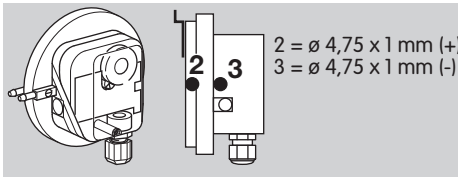

- Positive pressure: port 2
- Negative pressure: port 3

DL 5-150K

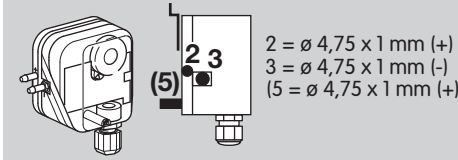

- Positive pressure: port 2
- Negative pressure: port 3
- Optional test point for positive pressure: port 5

Positive pressure measurement

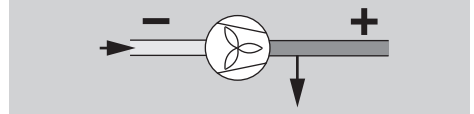

- 1 or 2 = positive pressure port (+).
- If port 2 is used, close off port 1.
- 3 or 4 = remains open to ventilate the upper diaphragm chamber.

Negative pressure measurement

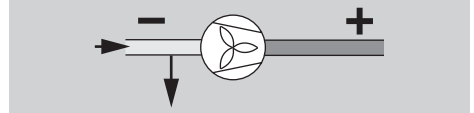

- 3 or 4 = negative pressure port (-).
- 1 or 2 = remains open to ventilate the upper diaphragm chamber.

Differential pressure measurement

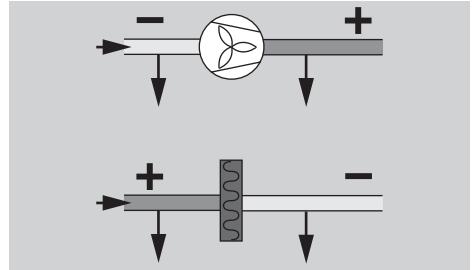

- 1 or 2 = port for the higher positive pressure or lower negative pressure (+).
- 3 or 4 = port for the lower positive pressure or higher negative pressure (-).

- 3** Seal the ports that are not in use.

Wiring

- If the DL..G (DL..TG) has switched a voltage > 24 V (> 30 V) and a current > 0.1 A at $\cos \varphi = 1$ or > 0.05 A at $\cos \varphi = 0.6$ once, the gold plating on the contacts will have been burnt through. It can then only be operated at this power rating or higher power rating.

! CAUTION

To ensure that the DL is not damaged during operation, note the switching capacity, see page 5 (Technical data).

- In the case of low switching capacities, such as 24 V, 8 mA, for example, we recommend using an RC module (22 Ω , 1 μ F) in air containing silicone or oil.

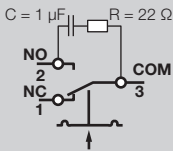

1 Disconnect the system from the electrical power supply.

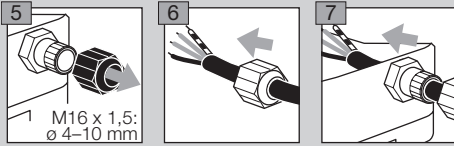
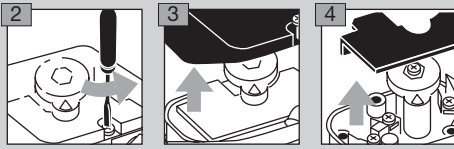

▷ Contacts **3** and **2** close when subject to increasing pressure. Contacts **1** and **3** close when subject to falling pressure. With the NO contact, the NC contact is omitted.

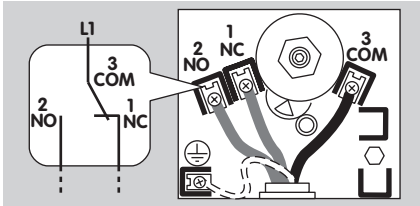

DL 1,5A

▷ The connection depends on the positive or negative adjusting range.

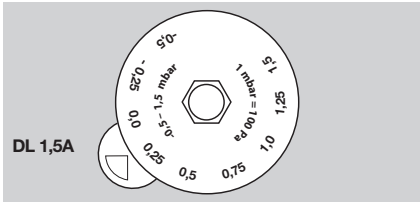

▷ Negative adjusting range 0 to -0.5 mbar: contacts 3 and 1 close when subject to increasing negative pressure. Contacts 2 and 3 close when subject to falling negative pressure.

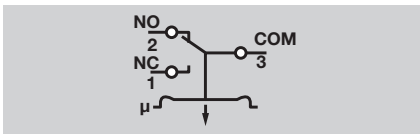

Adjustment

▷ The switching point is adjustable via hand wheel.

- 1** Disconnect the system from the electrical power supply.
- 2** Detach the housing cover, see page 5 (Technical data).
- 3** Connect an ohmmeter.

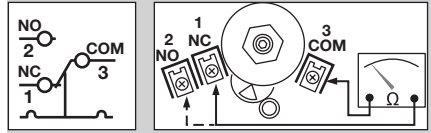

- 4** Set the switching point using the hand wheel.
- 5** Connect a pressure gauge.

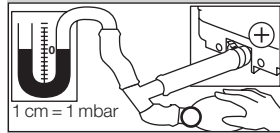

6 Apply pressure. In doing so, monitor the switching point on the ohmmeter and the pressure gauge.

▷ Max. inlet pressure = withstand pressure

Type	Adjusting range* mbar		Max. inlet pressure mbar	Switching differential** mbar	
	min.	max.		min.	max.
DL 1,5A	-0.5	1.5	50	0.1	0.16
DL 3A, ..3K	0.2	3	50	0.1	0.16
DL 3AT, ..3KT	0.3	3	150	0.1	0.16
DL 5A, ..5K	0.4	6	300	0.2	0.3
DL 5AT, ..5KT	0.5	5	300	0.2	0.3
DL 10A, ..10K, ..10AT, ..10KT	1	10	300	0.25	0.4
DL 30A, ..30K	2.5	30	300	0.35	0.9
DL 50A, ..50K, ..50AT, ..50KT	2.5	50	300	0.8	1.5
DL 150A, ..150K	30	150	300	3	5

Type	Adjusting range* "WC		Max. inlet pressure "WC	Switching differential** "WC	
	min.	max.		min.	max.
DL 3AT, ..3KT	0.12	1.2	58.5	0.04	0.06
DL 5AT, ..5KT	0.2	2	117	0.08	0.12
DL 10AT, ..10KT	0.4	4	117	0.1	0.16
DL 50AT, ..50KT	1	20	117	0.3	0.6

* Adjusting tolerance $\pm 15\%$ of the scale value, but min. ± 4 Pa

** Mean switching differential at min. and max. setting

- ▷ Deviation from the switching point during testing pursuant to EN 1854:

Air pressure switches:

	Deviation
DL 5–150A, DL 5–150K	± 15%
DL 1,5A	± 15% or ± 6 Pa
DL 3A, DL 3K	± 15% or ± 6 Pa

- ▷ If the DL does not trip at the desired switching point, correct the adjusting range using the hand wheel. Relieve the pressure and repeat the process.

Function check

- ▷ We recommend a function check once a year.
- ▷ Press the test key during operation – the pressure switch switches.

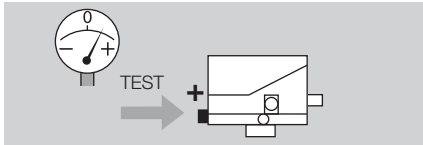

- ▷ In case of differential pressure, press both keys simultaneously.

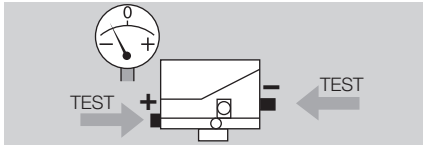

Accessories

See Technical Information DG (D, GB, F) – www.docuthek.com

Technical data

Ambient conditions

This unit is not suitable for cleaning with a high-pressure cleaner and/or cleaning products. Gas type: air or flue gas, no flammable gases, no aggressive gases.

Safety class II to VDE 0106-1.

Max. medium and ambient temperatures:

DL: -20 to +80°C (-4 to +176°F),

DL..T: -40 to +60°C (-40 to +140°F).

Long-term use in the upper ambient temperature range accelerates the ageing of the elastomer materials and reduces the service life (please contact manufacturer).

Enclosure to IEC 60529: IP 54, IP 65.

Mechanical data

Max. inlet pressure = withstand pressure: see type label or page 4 (Adjustment).

Diaphragm pressure switch, NBR, silicone-free.

Housing: glass fibre reinforced PBT plastic with low gas release.

Max. tightening torque, see Technical Information bulletin DL (D, GB, F) – www.docuthek.com.

Weight: DL..A: 190 g (6.7 oz), DL..K: 220 g (7.8 oz).

Electrical data

Micro switch to EN 61058-1.

Switching capacity:

DL..: 24 V (min. 0.05 A) to 250 V AC (max. 5 A, at $\cos \varphi = 0.6 = 1$ A).

DL..G: 5 V (min. 0.01 A) to 250 V AC (max. 5 A, at $\cos \varphi = 0.6 = 1$ A),

5 V (min. 0.01 A) to 48 V DC (max. 1 A),

DL..T: 30 – 240 V AC, 50/60 Hz,

5 A resistive or

0.5 A inductive ($\cos \varphi = 0.6$),

DL..TG: < 30 V AC/DC,

0.1 A resistive or

0.05 A inductive ($\cos \varphi = 0.6$).

Contact gap < 3 mm (μ).

Line entrance: M16 x 1.5 (1/2" NPT conduit),

clamping range: diameters of 4 to 10 mm.

Type of connection: screw terminals, cable diameter: 0.5 to 1.8 mm (AWG 24 to AWG 13).

Designed lifetime

This information on the designed lifetime is based on using the product in accordance with these operating instructions. Once the designed lifetime has been reached, safety-relevant products must be replaced. Designed lifetime (based on date of manufacture) in accordance with EN 13611, EN 1854 for pressure switches: 10 years, 250,000 switching cycles.

You can find further explanations in the applicable rules and regulations and on the afecor website (www.afecor.org).

This procedure applies to heating systems. For thermoprocessing equipment, observe local regulations.

Logistics

Transport

Protect the unit from external forces (blows, shocks, vibration).

Transport temperature:

DL: -20 to +80°C (-4 to +176°F),

DL..T: -40 to +60°C (-40 to +140°F).

Transport is subject to the ambient conditions described.

Report any transport damage on the unit or packaging without delay.

Check that the delivery is complete, see page 1 (Part designations).

Storage

Storage temperature: -20 to +40°C (-4 to +104°F).

Storage is subject to the ambient conditions described.

Storage time: 6 months before using for the first time. If stored for longer than this, the overall service life will be reduced by the corresponding amount of extra storage time.

Packaging

The packaging material is to be disposed of in accordance with local regulations.

Disposal

Components are to be disposed of separately in accordance with local regulations.

Certification

Declaration of conformity



We, the manufacturer, hereby declare that the product DL with product ID No. CE-0085AP0466 complies with the requirements of the listed Directives and Standards.

Directives:

– 2014/30/EU – EMC

– 2014/35/EU – LVD

Regulation:

– (EU) 2016/426 – GAR

Standards:

– EN 13611:2015+AC:2016

– EN 1854:2010

The relevant product corresponds to the tested type sample.

The production is subject to the surveillance procedure pursuant to Regulation (EU) 2016/426 Annex III paragraph 3.

Elster GmbH

Scan of the Declaration of conformity (D, GB) – see www.docuthek.com

FM, UL, AGA approvals, Eurasian Customs Union, RoHS compliant



Directive on the restriction of the use of hazardous substances (RoHS) in China

Scan of the Disclosure Table China RoHS2 – see certificates at www.docuthek.com

Contact

If you have any technical questions, please contact your local branch office/agent. The addresses are available on the Internet or from Elster GmbH.

We reserve the right to make technical modifications in the interests of progress.

Honeywell

**krom
schroder**

Elster GmbH

Strotheweg 1, D-49504 Lotte (Büren)

Tel. +49 541 1214-0

Fax +49 541 1214-370

hts.lotte@honeywell.com, www.kromschroeder.com