

ControlEdge HC900 IO Modules Specifications

51-52-03-41, January 2023



Overview

The Honeywell ControlEdge HC900 Controller is an advanced loop and logic controller offering a modular design sized to satisfy the control and data acquisition needs of a wide range of process equipment.

I/O Modules

The following I/O modules are available to create a custom control solution.

- 16 Channel Universal IO Module Galvanically isolated Input/Output to chassis (p.31)
- 8-point universal analog input modules: Galvanic isolation point to chassis inputs may be mixed on a module and may include multiple thermocouple types, RTDs, ohms, voltage or mill voltage types – all easily assigned using the Process Control Designer configuration tool. High point-to-point galvanic isolation simplifies installation and saves the expense of external isolation hardware (p.9).
- 16-point high level analog input module: each point is configurable for V or mA. Galvanically isolated point to chassis. Galvanically isolated point to point (p.13). 250-ohm shunt resistors can be added per channel.
- 4-point galvanically isolated analog output module. Galvanically isolated point to chassis supports from 0 to 20mA each (p.15).
- 8-point analog output, galvanically isolated in 2 groups of 4 points. Galvanically isolated point to chassis. Supports from 0 to 20mA each (p.16).
- 16-point analog output, galvanically isolated in 4 groups of 4 points. Galvanically isolated point to chassis. Supports from 0 to 20mA each (p.17).
- 16-point digital input modules: Contact closure type, DC Voltage, AC Voltage and AC/DC voltage types (p.18). Galvanically isolated in groups of 8 channel to chassis
- 32-point digital input module: DC voltage. Galvanically isolated point to chassis. Galvanically isolated in 2 groups of 16 points (p.2218).
- 8-point AC or 16-point DC digital output modules (sinking type). Galvanically isolated point to chassis. Galvanically isolated in 2 groups of 8 points (p.21).

- 32-point digital output: DC voltage (sourcing type). Galvanically isolated point to chassis. Galvanically isolated in 2 groups of 16 points (p.27).
- 8-point relay output module: four form C type and four form A type relays. Galvanically isolated point to chassis. Galvanically isolated relay to relay (p.23).
- 4 channel Pulse/Frequency/Quadrature I/O module. Galvanically isolated point to chassis (p.28).

Insert and Removal of I/O under Power

For ease of maintenance, the ControlEdge HC900 controller supports removing and inserting I/O modules from the module rack without removing power from the controller. Each module is sensed for validity by the controller and auto-configured on insertion.

Other Modules

In addition to I/O, the following modules are available.

- Scanner 1 module, single port (p.35)
- Scanner 2 Module, dual port (p.36)
- Universal AC Power Supply, 60W (p.7)
- Power Supply 24VDC, 60W (p.7)
- Redundant Switch Module (p.37)
- Power Status Module (p.37)

Failsafe

All ControlEdge 900 Platform I/O modules support a user specified failsafe value (analog) or state (digital) that the module outputs or inputs will assume if communication between the controller and the module is interrupted. Output modules are also disabled if the controller fails to start. Module diagnostics are not initiated if the control strategy does not call for the inputs or outputs on the modules to execute.

Failsafe is restricted to de-energize in safety applications.

Remote Terminal Panels

Optional DIN rail mounted Remote Terminal Panels (RTPs) are available for use with pre-wired cables to reduce installation time and labor expense. Four types of RTPs are available: analog inputs, relay outputs, redundant I/O and other I/O modules. Three cable lengths are also available to match hardware to installation variations. Analog inputs RTPs include transmitter shunt resistors and transmitter power terminals with individual circuit fuses. The Relay Output RTP includes a fuse and power disconnect switch for each output. All the three types of RTP panels also switch power to allow module removal and installation under controller power. See page 38.

Terminal Blocks

20-screw Barrier style and Euro style terminal blocks are available for use with all ControlEdge HC900 I/O Modules. Red terminal blocks are used for high voltage connections for added safety while black terminal blocks are used for low voltage connections. A 36-terminal Euro style block is available with the 16 AI, the 8 and 16 AO as well as the 32 DC DI and 32 DC DO module types. See page 31.

Specifications for modules

I/O Module Attributes	
Remove & Insert under power	Standard. Modules are automatically sensed and configured on insertion. Field power shall be disconnected before removing field terminal blocks.
LED Channel State indicators	Via light pipes at front of module, one state LED for each digital I/O point – green indicates ON, logic side
LED Module Status indicator	Via light pipe, one per module, tri-color to represent module status, Green = OK, Red = Fault (# of flashes indicates fault), Amber = Override (Force)
I/O Labels	Color-coded, on module door, removable, with write-on area to label I/O
Processor	Micro-controller per module for parallel processing
Terminal Boards	20 screw: Barrier or Euro style, tin-plated or gold-plated (for DC connections) 36 screw: Euro style gold plated (Required with certain higher capacity modules)
Keying	Hardware keying matches each module to its terminal block with its field wiring.
Environmental and Vibration Specifications	
Mounting Standard 35mm wide DIN Rail	Provides connection of field wiring to controller I/O within an enclosure only.
Dimensions	4.38" (111.1 mm) x 3.70" (94.0mm) x 2.60" (66.0mm) (L x W x H)
Vibration Amplitude Acceleration Vibration	5Hz to 15.77Hz, 2.03mm (0.08") amplitude (peak to peak) 15.77 to 250Hz, 1.0-g Sweeping, at rate of .33 octave/min.
Tray material Tray and end caps Flammability	Polyvinyl Chloride (PVC) UL94-V0
Environmental Temperature Relative Humidity Harsh Environment ** ROHS** ** Except PSU module	Operating: 0 deg. C (32F) to 60 deg. C (140F) Storage: -40 deg. C (140F) to 70 deg. C (158F) Operating: 10% to 90% Non-condensing Storage: 5% to 95% Non-condensing All the modules including CPU, Scanner, RTP, Backplane, RSM/PSM, and Backplanes have conformal coating that is suitable for operation in G3 level of harsh environment. Power Supply Units (PSU) do not have conformal coating. Entire system is compliant to RoHS 2 directive, except PSU.

Certifications CE	EN61326-1:2013, EN61326-3-1:2008, EN55011:2009/A1,2010, EN61010-1:2010
UL	Certificate: E201698 UL Listed- Process Control Equipment, Electrical UL 61010-1 2nd Edition
ATEX	Certificate: HON 08.0201 II 3 G Ex nA IIC T* Gc EN 60079-0: 2011; EN 60079-15: 2010 Compliance with the Essential Health and Safety Requirements, with the exception of those listed in the schedule to this certificate, has been assured by compliance with the following documents: EN IEC 60079-0:2018 EN 60079-7:2015+A1:2018 EN IEC 60079-15:2019
UKCA	Compliance with the Essential Health and Safety Requirements has been assured by compliance with: EN IEC 60079-0:2018 EN 60079-7:2015+A1:2018 EN IEC 60079-15:2019
IECEx	The equipment and any acceptable variations to it specified in the schedule of this certificate and the identified documents, was found to comply with the following standards: IEC 60079-0:2017 Edition:7.0 IEC 60079-15:2017 Edition:5.0 IEC 60079-7:2017 Edition:5.1
CSA	Certificate: 1367757 Class I, Division 2, Groups A, B, C D; T* CAN/ CSA C22.2 No. 0-M91; CAN/ CSA C22.2 No. 94-M94; CAN/ CSA C22.2 No 1010.1-92; CAN/ CSA C22.2 No 1010.1B-97; CSA C22.2 No. 213-M1987
FM	Certificate: 3011798 Class 1, Div. 2 Groups A, B, C, D; T* FM 3600: 2010; FM 3611: 2004; FM 3810: 2005 * Module Temperature: Classifications T3 to T6
Cables High voltage Low voltage	Lengths: 1.0, 2.5, 5.0 meters. Cable power is limited to 24 Amps per module at 60C (140 degrees F) and 32 Amps at 54C (129 degrees F). Lengths: 1.0, 2.5, 5.0 meters.
I/O module Compliance	
CE Conformity	This product is in conformity with the protection requirements of the following European Council Directives: 2006/ 95/ EC , the Low Voltage Directive (evaluated to EN61010-1:2010) 2004/108/EC , the EMC Directive (evaluated to EN61326-1:2013). Conformity of this product with any other European Council Directive(s) shall not be assumed.
General Purpose Safety	Compliant with EN61010-1, UL61010-1 2nd Edition, CSA C22.2 No. 1010-1
Hazardous (Classified) Location Safety	FM Class 1, Div. 2, Groups A, B, C, D Class 1, Zone 2, IIC
Module Type	
Temperature Classification	
Controller (C30, C50, C70, C75)	T4
Safety Module Controller (C30S, C50S, C70S and C75S)	T4
Power Supply (P01, P24)	T4

Power Status (PSM))	T6
Scanner (1 or 2 Port)	T4
Safety Scanner (1 or 2 Port)	T4
Redundant Switch (RSM)	T6
Analog Input (Universal 8 channel)	T6
Analog Input (High Level 16 channel)	T6
Analog Output (4 Channel)	T4
Analog Output (8 channel)	T4
Analog Output (16 channel)	T3C
Digital Input, Contact type (16 Channel)	T5
Digital Input, 24 Vdc (16 channel)	T4
Digital Input, 120/240 Vac (16 channel)	T3C@ Ta = 60 deg. C T4 @ Ta = 40 deg. C
Digital Input, 120/240 Vac (16 channel 125 Vdc)	T3C@ Ta = 60 deg. C T4 @ Ta = 40 deg. C
Digital Input Vdc (32 channel)	T3C@ Ta = 60 deg. C T4 @ Ta = 40 deg. C
Digital Output, Relay type (8 channel)	T5
Digital Output, 24 Vdc, (16 channel)	T4
Digital Output, 120/240 Vac (8 channel)	T4
Digital Output Vdc (32 channel)	T6
Pulse/Frequency/Quadrature (4 channel)	T5
Universal IO Module (900U02)	T4

Dimensions and Weight

Item	Module Number	Dimension	Weight
4 I/O slot Rack ^{1,2}	900R04-0300	137mm H* x 266.7mm W x 151.7mm D 5.4" H* x 10.5" W x 6.0" D	2104g
8 I/O slot Rack ^{1,2}	900R08-0300	137mm H* x 419.1mm W x 151.7mm D 5.4" H* x 16.5" W x 6.0" D	3126g
8 I/O slot Rack with redundant power support ^{1,2}	900R08R-0300	137mm H* x 530.9mm W x 151.7mm D 5.4" H* x 20.9" W x 6.0" D	4422g
12 I/O slot Rack ^{1,2}	900R12-0300	137mm H* x 571.5mm W x 151.7mm D 5.4" H* x 22.5" W x 6.0" D	4072g
12 I/O slot Rack with redundant power support ^{1,2}	900R12R-0300	137mm H* x 683.3mm W x 151.7mm D 5.4" H* x 26.9" W x 6.0" D	5252g
Redundant CPM Rack ^{1,2}	900RR0-0300	137mm H* x 261.6mm W x 151.7mm D 5.4" H* x 10.3" W x 6.0" D	1751g
CPU, ControlEdge 900	900C30-0460/ 900C30S-0460	137mm H x 38.1mm W 5.4" H* x 1.5" W	350g
	900C50-0460/ 900C50S-0460	137mm H x 38.1mm W 5.4" H* x 1.5" W	360g

	900C70-0460/ 900C75-0560/ 900C70S-0460/ 900C75S-0560	137mm H x 38.1mm W 5.4" H* x 1.5" W	400g
Scanner, ControlEdge 900	900S50-0460/ 900S50S-0460	137mm H x 38.1mm W 5.4" H* x 1.5" W	360g
	900S75-0460/ 900S75S-0460	137mm H x 38.1mm W 5.4" H* x 1.5" W	400g
SIL UIO	900U02-0100	134mm H x 33.1mm W 5.3" H* x 1.3" W	260g
Universal AI -RTD, TC, V, 8 Ch	900A01-0202	137mm H x 35.6mm W 5.4" H* x 1.4" W	210g
Analog Input hi level, 16 Ch	900A16-0103	137mm H x 35.6mm W 5.4" H* x 1.4" W	397g
Analog Output, 0 to 20mA, 4 Ch	900B01-0301	137mm H x 35.6mm W 5.4" H* x 1.4" W	408g
Analog Outputs 0 to 20mA, 8 Ch	900B08-0202	137mm H x 35.6mm W 5.4" H* x 1.4" W	400g
Digital Input 120/240 VAC, 16 Ch	900G03-0202	137mm H x 35.6mm W 5.4" H* x 1.4" W	210g
Digital Input 24VDC, 32 Ch	900G32-0301	137mm H x 35.6mm W 5.4" H* x 1.4" W	175g
Digital Input, Contact type, 16 Ch	900G01-0202	137mm H x 35.6mm W 5.4" H* x 1.4" W	354g
Digital Input, 120/240 VAC- 125VDC, 16 Ch	900G04-0101	137mm H x 35.6mm W 5.4" H* x 1.4" W	400g
Digital Output - 120/240 VAC, 8 Ch	900H03-0202	137mm H x 35.6mm W 5.4" H* x 1.4" W	230g
Digital Output – 24VDC, 32 Ch	900H32-0302	137mm H x 35.6mm W 5.4" H* x 1.4" W	180g
Digital Output, Relays, 8 Ch	900H01-0202	137mm H x 35.6mm W 5.4" H* x 1.4" W	425g
Pulse/Freq, (4chan)	900K01-0201	137mm H x 35.6mm W 5.4" H* x 1.4" W	360g
Power Supply 120/240VAC, 60W	900P01-0501	137mm H x 72.6mm W 5.4" H* x 2.86" W	820g
Power Supply 24VDC, 60W	900P24-0501	137mm H x 72.6mm W 5.4" H* x 2.86" W	792g
SIL - Power Supply 120/240VAC, 60W	900P01-0601	137mm H x 72.6mm W 5.4" H* x 2.86" W	650g
SIL - Power Supply 24VDC, 60W	900P24-0601	137mm H x 72.6mm W 5.4" H* x 2.86" W	650g
Power Status Module, Redundant	900PSM-0200	137mm H x 35.6mm W 5.4" H* x 1.4" W	448g
MOXA Network Switch (8 ports)	50008930-001	135mm H x 53.6mm W x 105mm D 5.31" H* x 2.11" W x 4.13" D	790g
MOXA: Network switch, 16 Port Multi-mode	50008930-002	135mm H x 80.1mm W x 105mm D 5.31" H* x 3.15" W x 4.13" D	1140g
MOXA: IMC-101-M-SC Fiber Optic convertor	50135395-001	135mm H x 53.6mm W x 105mm D 5.31" H* x 2.11" W x 4.13" D	630g
MOXA Network Switch (8 ports), Single mode	50008930-004	135mm H x 53.6mm W x 105mm D 5.31" H* x 2.11" W x 4.13" D	790g
MOXA: Network switch, 16 Port Single mode	50008930-003	135mm H x 80.1mm W x 105mm D 5.31" H* x 3.15" W x 4.13" D	1140g
MOXA: IMC-101-S-SC Fiber Optic convertor, Single mode	50135395-002	135mm H x 53.6mm W x 105mm D 5.31" H* x 2.11" W x 4.13" D	630g
Ethernet Switching Hub, 16 ports, Multi-Mode, G3	50008930-008	135mm H x 53.6mm W x 105mm D 5.31" H* x 2.11" W x 4.13" D	1140g
Ethernet to Multi-Mode Fiber Converter, G3	50135395-003	135mm H x 53.6mm W x 105mm D 5.31" H* x 2.11" W x 4.13" D	630g

Note:

1. Surface mounting with 4 screws in back of rack. Installation Category II, Pollution Degree 2, IEC 60664, UL840 Installation coordination.
2. Rear mounting plate extends height to 6.9" (175.3mm).

Power Supply

P01 Power Supply (900P01-xxxx)

The P01 power supply provides 5VDC and 24VDC to satisfy the power requirements of a rack with a controller and local I/O, a rack with a scanner, and remote I/O. The 60-watt capacity allows for almost any mix of I/O modules in one rack. See Module Specifications starting on page 6. A tool-secured door covers the high voltage connections; test jacks behind the door allow for quick verification of proper operation. An internal non-replaceable fuse limits supply current under certain fault conditions.



P24 Power Supply (900P24-xxxx)

The P24 power supply provides 5VDC and 24VDC to satisfy the power requirements of a rack with a controller and local I/O, a rack with a scanner and remote I/O or a redundant controller rack. The 60-watt capacity requires minimal de-rating of the available ControlEdge HC900 I/O modules. A tool-secured door covers the voltage connections. An internal non-replaceable fuse limits supply current under certain fault conditions.

	P01 Power Supply (900P01- xxxx)	P24 Power Supply (900P24-xxxx)
Wiring	Screw type terminals, Wire gauge #12-22 AWG	Screw type terminals, Wire gauge #12-22 AWG
Operating Voltage	Universal Power, 90-264VAC, 47-63 Hz	21-29VDC
Input Rating	130VA	72.5W
Output Rating	60W	60W
In Rush Current	7 Amps peak-to-peak for 150 ms at 240 VAC	In-rush current: 30A for 3ms @29VDC
Fuse	Internal, non-replaceable	Internal, non-replaceable
Test jacks	5 volt, 24 Volt	None
Hold up time	20milliseconds @ 115VAC, 60HZ maximum Load	

See next section for how to choose an AC power supply.

How to choose an AC Power Supply

Module	ControlEdge HC900 Hardware Power (Watts)	Field Power (Watts)	Total Power (Watts)
Controller C30 and C30S	6.0	0.0	6.0
Controller C50 and C50S	6.0	0.0	6.0
Controller C70 and C70S	7.1	0.0	7.1
Controller C75 and C75S	7.8	0.0	7.8
Redundancy switch module (RSM)	0.1	0.0	0.1
Power Status Module (PSM)	0.1	0.0	0.1
Scanner 1 Port (S50/S50S)	3.9	0.0	3.9
Scanner 2 Port (S75/S75S)	5.0	0.0	5.0
Analog Input (Universal)	0.8	0.0	0.8
Analog Input (High level)	1.6	0.0	1.6
Analog Output (4 points)*	5.1	0.0	5.1
Analog Output (8 pts. internal 24V)***	9.4	0.0	9.4
Analog Output (8 pts. external 24V)***	1.1	8.3	9.4
Analog Output (16 pts. internal 24V)***	18.3	0.0	18.3
Analog Output (16 pts. external 24V)***	1.7	16.6	18.3
Contact Input	1.6	0.0	1.6
Relay Output	3.0	0.0	3.0
16 pt DC In (@ 24V)	0.7	2.6	3.3
16 pt DC In (@ 32V)	0.7	5.1	5.7
32 pt DC In (@ 24V)	1.1	3.1	4.2
32 pt DC In (@ 32V)	1.1	5.1	6.2
16 pt DC Out	1.7	1.2	2.9
32 pt DC Out	1.2	1.8	3.0
AC In (@120V)	0.7	1.9	2.6
AC In (@240V)	0.7	7.7	8.3
AC/DC In	0.7	7.7	8.3
AC Out	1.1	12.0	13.1
PFQ**	6.7	0.1	6.8
Universal IO (16 Pts)	2.45	4.5	6.95
<p>*Limit 10 Analog Output modules per I/O rack.</p> <p>** Limit 4 PFQ modules per I/O rack.</p> <p>***Limit 2 16-pt. modules per rack.</p> <p>***Limit 5 8-pt. modules per rack with internal power supply.</p>			

Analog Input Module (900A01-xxxx)

The Universal Analog Input module supports up to 8 user-configurable inputs on a per point basis for thermocouple, RTD, Resistance, V, mV, mA or slidewire. Point-to-point isolation and back-plane isolation are provided. Modules perform analog to digital conversion in synchronization with CPU control execution, eliminating data interchange latency. All analog input modules are processed in parallel, eliminating scan time increases as modules are added.

A green blinking status LED on the module indicates when the module is being scanned. An amber blinking status LED when input channels are forced and a red status LED when module diagnostics exist. A user-selectable failsafe value is supported on a per channel basis. A warning signal is provided for thermocouple inputs to indicate maintenance is needed prior to a sensor failure. A sensor failure signal is also provided.

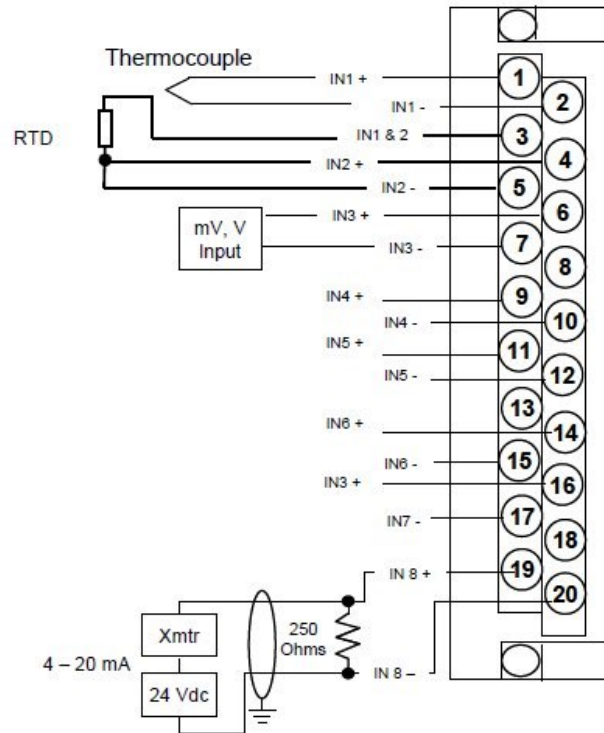

Table 1 - Analog Input Specifications

Inputs per module	8 (isolated)
Input types	mV, V, T/C, RTD, ohms, mA, slidewire assigned to any channel
Signal Source	See Table 2 on page Error! Bookmark not defined. for range types. Thermocouple with cold junction compensation RTD, PT100 3 wire, 40 ohms balanced maximum Thermocouples: 100 Ohms/Leg 100 (except Low), 500 & 1000 RTD: 100 Ohms/Leg 100 YIS: 100 Ohms/Leg 100-Low RTD & 10 ohm Cu: 10 Ohms/Leg Slidewire 100 to 6,500 Ohms: 10% of total res./leg
Input Impedance	10 megohms for T/C and mV inputs; >1 megohm for volts and 250 ohms for mA inputs
Galvanic Input Isolation	400 VDC point to point, 1K VDC to logic RTDs are isolated in pairs (I _{RTD} is common to two inputs).

Table 1 - Analog Input Specifications	
Noise Rejection	Series Mode >60dB. Common Mode >130dB at 120VAC.
Burnout	T/C, mV, V (except for ranges below) configurable to upscale, downscale, defined value, or none. <i>Volt</i> : -500 mV to 500 mV; -1 V to 1 V; -2 V to 2 V; -5 V to 5 V; 0 V to 10 V; -10 V to 10 V; inherent to zero volt <i>RTD</i> : Inherent upscale <i>mA</i> : Inherent downscale
Over-range limit	+/- 10% for linear ranges (volts). +/-1% for non-linear ranges (T/C, RTD).
T/C Break Detection	Via current pulse
Faulty thermocouple detection	If greater than 100 ohms, a warning status is provided as an output for the AI block
Accuracy	Factory configured accuracy = ± 0.1 % of range (± 0.2 % of range for 0V to 10V and -10V to 10V) Cold junction accuracy = ± 0.7 °C Field calibration accuracy = ± 0.05 % of range <i>Reference conditions:</i> Temperature = 25 °C \pm 3 °C (77 °F \pm 5 °F) Humidity = 45 % to 55 % RH non-condensing Line voltage = Nominal \pm 1 % Source resistance = 0 ohm Series mode and common mode = 0 V Frequency = Nominal \pm 1 % Note: In the case of temperature sensing using a thermocouple, forced heating or cooling on the module affects the temperature of the terminal block surface and the air around it, this change in temperature further impacts the factory configured accuracy. User is recommended not to expose the module to the forced airflow.
Temp. Effect on Accuracy	$\pm 0.01\%$ of full scale per degree Celsius maximum
A/D Converter	One per module
A/D Resolution	15 Bits
Reference Junction Sensing	Via 2 RTDs at top/bottom of module
Update rate	500ms (Analog to Digital Converter per module)
Long term Stability	0.1% per year
Calibration	Data is stored in non-volatile memory Redundant Factory Calibration Individual Channel Field Calibration
Diagnostics	Monitoring of Factory Calibration, Field Calibration, 24 VDC supply, and configuration.
Channel Configuration Data	Stored in non-volatile memory
Power supply loading	5V; 40mA max 24V; 25mA max

Table 2 – Analog Input Reference Accuracy				
Input Type	Range		Reference Accuracy	
Thermocouple inputs	°F	°C	°F	°C
B T/C	0 to 105	-18 to 41	NA	NA
	105 to 150	41 to 66	55.0	30.6
	150 to 500	66 to 260	30.0	16.7
	500 to 1000	260 to 538	8.0	4.5
	1000 to 3300	538 to 1815	4.0	2.3
E T/C	-454 to -202	-270 to -130	25.0	14.0
	-202 to 1832	-130 to 1000	2.3	1.3
E (low) T/C	-200 to 1100	-129 to 593	2.0	1.2
J T/C	0 to 1600	-18 to 871	1.2	0.6
J (low) T/C	20 to 770	-7 to 410	1.0	0.5
J T/C	-292 to 32	-180 to 0	1.0	0.5
K T/C	0 to 2400	-18 to 1316	2.0	1.2
K (low) T/C	-20 to 1000	-29 to 538	1.6	0.8
K T/C (mid)**	0 to 1800	-18 to 982	1.8	1.0
K T/C	32 to 2192	0 to 1200	2.0	1.2
Ni-NiMo (NNM68)	32 to 500	0 to 260	2.0	1.2
	500 to 2500	260 to 1371	1.5	0.8
Ni-NiMo (low)	32 to 1260	0 to 682	1.3	0.7
NiMo-NiCo (NM90)	32 to 500	0 to 260	2.0	1.2
	500 to 2500	260 to 1371	1.5	0.7
NiMo-NiCo (low)	32 to 1260	0 to 682	1.3	0.7
N T/C	0 to 2372	-18 to 1300	2.0	1.2
N T/C	0 to 1472	-18 to 800	1.4	0.9
N T/C	32 to 2192	0 to 1200	2.0	1.2
R T/C	0 to 500	-18 to 260	5.0	2.8
	500 to 3100	260 to 1704	2.2	1.2
S T/C	0 to 500	-18 to 260	4.5	2.5
	500 to 3100	260 to 1704	2.2	1.2
T T/C	-300 to 700	-184 to 371	4.0	2.3
	-100 to 700	-73 to 371	2.0	1.2
T (low) T/C	-200 to 500	-129 to 260	1.0	0.5
W ₅ W ₂₆	-4 to 600	-20 to 2320	27.0	15.0
	600 to 3600	316 to 1982	4.0	2.3
	3600 to 4200	1982 to 2316	4.2	2.4
W ₅ W ₂₆ T/C *	0 to 600	-18 to 316	3.5	2.0
	600 to 3600	316 to 1982	3.0	1.7
	3600 to 4200	1982 to 2316	3.5	2.0
W ₅ W ₂₆ (low) T/C*	0 to 2240	-18 to 1227	2.5	1.4

* W₅W₂₆ is also known as type "C" Thermocouple.

** Type K thermocouple (mid-range) has a working range from 75 to 1800 °F, 25 to 982 °C. Input measurements below 75°F or 25°C may cause the input to default to the programmed failsafe value. Use type K low or full ranges if measurements are required outside the mid- working range.

RTD	°F	°C	°F	°C
Platinel	-94 to 1382	-70 to 750	3.0	1.7
Platinel (low)	32 to 2516	0 to 1380	1.5	0.8
100 Pt. (high) RTD***	-300 to 1500	-184 to 816	1.8	1.0
100 Pt. (mid) RTD***	-300 to 1200	-184 to 649	1.4	0.8
100 Pt. (low) RTD***	-300 to 600	-184 to 316	0.9	0.5
500 Pt. RTD***	-300 to 1200	-184 to 649	0.9	0.5
1000 Pt RTD*****	-40 to 500	-40 to 260	0.8	0.4
100 JIS	-328 to 932	-200 to 500	1.3	0.7
100 JIS (low)	0 to 212	-18 to 100	0.5	0.3
Cu10	-4 to 482	-20 to 250	2.0	1.0
YSI405	50 to 100	10 to 37.8	0.05	0.03
Input Type	Range		Reference Accuracy	
Ohms, 200	0 to 200		+/- 0.4 ohms	
Ohms, 500	0 to 500		+/- 1.0 ohms	
Ohms, 1000	0 to 1000		+/- 2.0 ohms	
Ohms, 2000	0 to 2000		+/- 4.0 ohms	
Ohms, 4000	0 to 4000		+/- 8.0 ohms	
Milliamperes	4 to 20 mAdc 0 to 20 mAdc		± 0.2% F.S. (mA)**** ± 0.2% F.S. (mA)****	
Millivolts	0 to 10 mVDC 0 to 50 mVDC 0 to 100 mVDC -10 to 10 mVDC -50 to 50 mVDC -100 to 100 mVDC -500 to 500 mVDC		± 0.17% F.S. (mV) ± 0.1% F.S. (mV) ± 0.1% F.S. (mV) ± 0.2% F.S. (mV) ± 0.1% F.S. (mV) ± 0.1% F.S. (mV) ± 0.1% F.S. (mV)	
Volts	1 to 5 VDC 0 to 1 VDC 0 to 2 VDC 0 to 5 VDC 0 to 10 VDC -1 to 1 VDC -2 to 2 VDC -5 to 5 VDC -10 to 10 VDC		± 0.1% F.S. (mV) ± 0.1% F.S. (mV) ± 0.1% F.S. (mV) ± 0.1% F.S. (mV) ± 0.2% F.S. (mV) ± 0.1% F.S. (mV) ± 0.1% F.S. (mV) ± 0.1% F.S. (mV) ± 0.2% F.S. (mV)	
Slidewire	≤ 250 ohms 250 to 1250 ohms 1250 to 4000 ohms 4000 to 6500 ohms			
Carbon	0 to 1250 mVDC		± 0.1% F.S. (mV)	
Oxygen	-30 to 510 mVDC		± 0.1% F.S. (mV)	

*** Conforms to IEC751, DIN 0.00385 Ohm/ Ohm/ DegC

**** Tolerances for these input types include that of the external Dropping Resistors.

***** DIN 0.00375 Ohm/Ohm/ DegC

Calibration standards are based on ITS-90; except Ni-NiMo is based on IPTS-68.

High Level Analog Input Module (900A16-xxxx)

The High-Level Analog Input module supports up to 16 user-configurable inputs on a per point basis for Voltage or current. Point-to-point isolation and back-plane isolation are provided. Modules perform analog to digital conversion in synchronization with CPU control execution, eliminating data interchange latency. All analog input modules are processed in parallel, eliminating scan time increases as modules are added.

A green blinking status LED on the module indicates when the module is being scanned. An amber blinking status LED when input channels are forced and a red status LED when module diagnostics exist. A user-selectable failsafe value is supported on a per channel basis.

The module supports field calibration. Each of the inputs has its own integrated 250-ohm shunt resistor which is activated through DIP switches.

Requires Euro style 36-terminal terminal block.

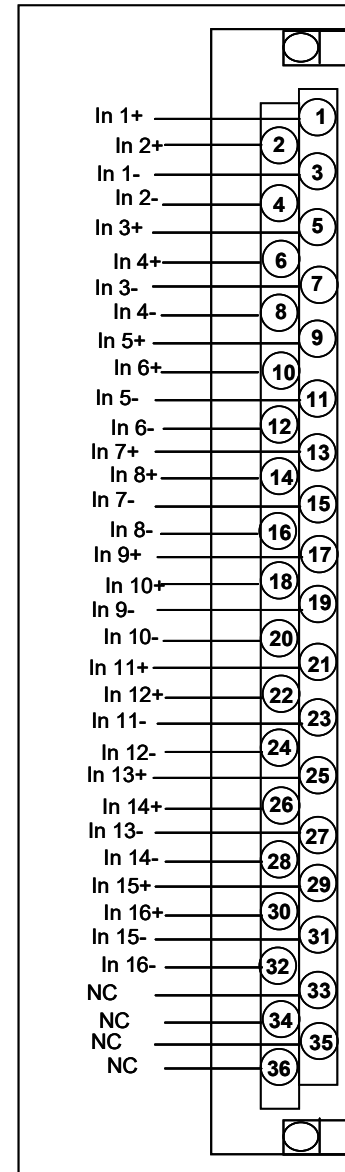

Table 3 – High Level Analog Input Specifications	
Inputs per module	16 (isolated)
Input types	V, mA
Signal Source	See Table 4 on next page for range types.
Input Impedance	>1 megohm for volts and 250 ohms for mA inputs
Galvanic Input Isolation	400 VDC point to point, solid state switching; 1K VDC to logic.
Noise Rejection	Series Mode >31dB Common Mode >90dB at 120VAC
Over-range limit	+/- 10% for linear ranges (volts).

Table 3 – High Level Analog Input Specifications	
Accuracy	Factory configured accuracy = ± 0.1 % of range. Field calibration accuracy = ± 0.05 % of range <i>Reference conditions</i> Temperature = $25\text{ }^{\circ}\text{C} \pm 3\text{ }^{\circ}\text{C}$ ($77\text{ }^{\circ}\text{F} \pm 5\text{ }^{\circ}\text{F}$) Humidity = 45 % to 55 % RH non-condensing Line voltage = Nominal ± 1 % Source resistance = 0 ohm Series mode and common mode = 0 V Frequency = Nominal ± 1 %
Temp. Effect on Accuracy	$\pm 0.01\%$ of full scale per degree Celsius maximum
A/D Converter	One per module
A/D Resolution	± 15 Bits
Update rate	100ms (Analog to Digital Converter per module)
Long term Stability	0.1% per year
Calibration	Data is stored in non-volatile memory Redundant Factory Calibration Individual Channel Field Calibration
Diagnostics	Monitoring of Factory Calibration, Field Calibration, 24 VDC supply, and configuration.
Channel Configuration Data	Stored in non-volatile memory.
Power supply loading	5V ; 75mA max 24V ; 50mA max

Table 4 - High Level Analog Input Reference Accuracy		
Input Type	Range	Reference Accuracy
Milliamperes	4 to 20 mAdc	$\pm 0.15\%$ F.S. (mA)**
	0 to 20 mAdc	$\pm 0.15\%$ F.S. (mA)**
**Tolerances for these input types include that of the internal Dropping Resistors.		
Volts	0 to 1VDC	$\pm 0.1\%$ F.S. (mV)
	0 to 2 VDC	$\pm 0.1\%$ F.S. (mV)
	0 to 5 VDC	$\pm 0.1\%$ F.S. (mV)
	0 to 10 VDC	$\pm 0.1\%$ F.S. (mV)
	1 to 5 VDC	$\pm 0.1\%$ F.S. (mV)
	-1 to 1 VDC	$\pm 0.1\%$ F.S. (mV)
	-2 to 2 VDC	$\pm 0.1\%$ F.S. (mV)
	-5 to 5 VDC	$\pm 0.1\%$ F.S. (mV)
	-10 to 10 VDC	$\pm 0.1\%$ F.S. (mV)

Analog Output Module (900B01-xxxx)

The Analog Output module provides 4 isolated 0 to 21.8 mA outputs that may be scaled by the user to any span within this range on a per output basis.

A green blinking status LED on the module indicates when the module is being scanned. A red status LED when module or channel diagnostics exist. A user specified failsafe value is supported to allow predictable operation in the event communication between the module and the controller is interrupted.

Outputs are updated synchronous with control execution. A user specified rate of change limit may be applied to each output when needed.

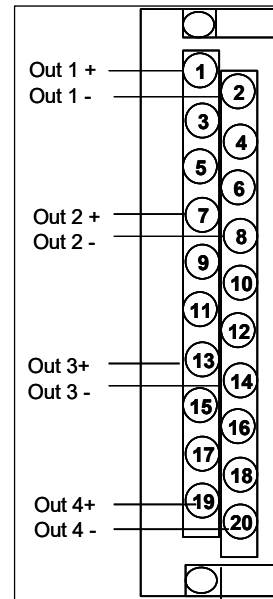

Outputs per module	4 (isolated)
Current	0 to 21.8 mA, range selectable
Load resistance	750 ohms max
Galvanic Isolation	500VDC Channel to Channel.
Galvanic Isolation from logic	600 VDC
Accuracy	0.1% full scale at reference conditions
Modules per rack	10 max, up to 12 with product ambient temperature de-rating (see figure below)
Minimum current sensing	> 3.5 mA per output
Calibration Data	Data is stored in non-volatile memory. Redundant Factory Calibration, with automatic rejection of Bad version. Individual Channel Field Calibration
Diagnostics	Monitoring of Factory Calibration, Field Calibration, Configuration, and +24 VDC power supply.
Output Verification	Feedback to controller that indicates output current flowing.
D/A Resolution	12 bits
Power Supply Loading	5V ; 40mA max 24V ; 200mA max

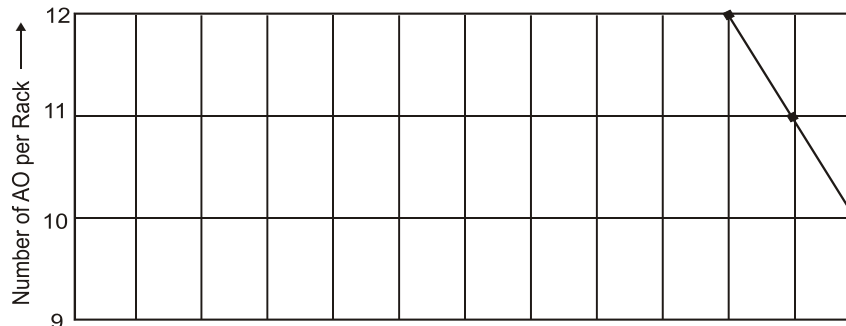

P01 Power Supply De-rating for AO Modules

Analog Output Module (900B08-xxxx)

The Analog Output module provides eight 0 to 21.0 mA outputs that may be scaled by the user to any span within this range on a per output basis. Outputs are isolated in groups of 4 with no isolation between outputs in a group. All points are isolated from controller logic.

A green blinking status LED on the module indicates when the module is being scanned. A red status LED when module or channel diagnostics exist. A user specified failsafe value is supported to allow predictable operation in the event communication between the module and the controller is interrupted.

Outputs are updated synchronous with control execution. A user-specified rate of change limit may be applied to each output when needed. Requires Euro style 36-terminal terminal block.

Outputs per module	8, isolated in 2 groups of 4 outputs (1-4, 5-8)
Current	0 to 21.0 mA, range selectable
Load resistance	750 ohms max
Galvanic Isolation	500VDC group to group. Groups 1-4, 5-8
Galvanic Isolation from logic	500 VDC
Accuracy	0.1% full scale at reference conditions
Modules per rack	4 max when powered from internal 24V backplane power
Minimum current sensing	>0.5mA per output
Calibration Data	Data is stored in non-volatile memory. Redundant Factory Calibration, with automatic rejection of Bad version. Individual Channel Field Calibration
Diagnostics	Monitoring of Factory Calibration, Field Calibration, Configuration
Output Verification	Feedback to controller to indicate output current is flowing.
D/A Resolution	13+ bits (1 part in 13332)
Power Supply Loading	5V ; 225 mA max 24V ; 350 mA max
Terminal Block	36 Position – Euro style, (Model 900TCK-0001)

A DIP switch on the module selects the use of 24V from Rack PS (internal) power or external loop power via a separate 24V DC power source. The as-shipped (default) switch setting is external power.

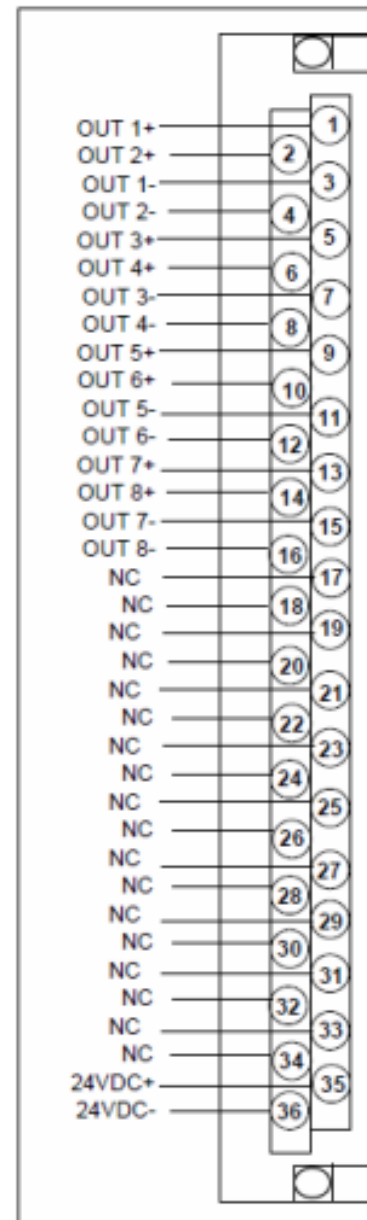

External Power Source requirements:

Voltage	Vin: 18 to 36 Vdc
Current	350 mA per module

Analog Output Module (900B16-xxxx)

The Analog Output module provides 16, 0 to 21.0 mA outputs that may be scaled by the user to any span within this range on a per output basis. Outputs are isolated in groups of 4 with no isolation between outputs in a group. All points are isolated from controller logic.

A green blinking status LED on the module indicates when the module is being scanned. A red status LED when module or channel diagnostic exist. A user specified failsafe value is supported to allow predictable operation in the event communication between the module and the controller is interrupted.

Outputs are updated synchronous with control execution. A user-specified rate of change limit may be applied to each output when needed. Requires Euro style 36-terminal terminal block.

Outputs per module	16, isolated in 4 groups of 4 outputs (1-4, 5-8, 9-12, 13-16)
Current	0 to 21.0 mA, range selectable
Load resistance	750 ohms max
Galvanic Isolation	500VDC group to group. Groups 1-4, 5-8, 9-12, 13-16.
Galvanic Isolation from logic	500 VDC
Accuracy	0.1% full scale at reference conditions
Modules per rack	2 max when powered from internal 24V backplane power.
Minimum current sensing	> 0.5mA per output
Calibration Data	Data is stored in non-volatile memory. Redundant Factory Calibration, with automatic rejection of Bad version. Individual Channel Field Calibration
Diagnostics	Monitoring of Factory Calibration, Field Calibration, and Configuration.
Output Verification	Feedback to controller to indicate output current is flowing.
D/A Resolution	13+ bits (1 part in 13332)
Power Supply Loading	5V ; 350 mA max 24V ; 700 mA max
Terminal Block	36 Position – Euro style, (Model 900TCK-0001)

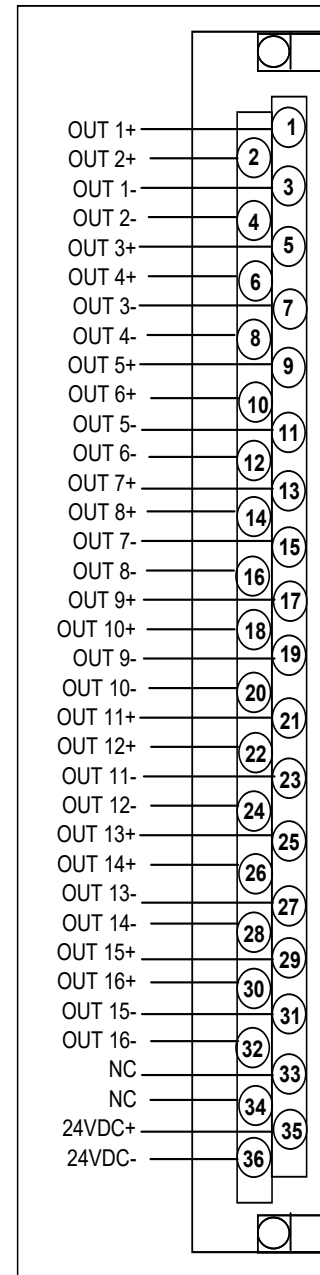

A DIP switch on the module selects the use of 24V from rack PS (internal) power or external loop power via a separate 24V DC power source. The as-shipped (default) switch setting is external power.

External Power Source requirements:

Voltage	18 to 36 Vdc
Current	700 mA per module

Digital Input Module – Contact Closure Type (900G01- xxxx)

The Contact Closure Digital Input Module is self-powered, providing 15VDC to external switching hardware to close the input loop. A closed external circuit causes current flow to the input to establish an ON state. Logic in the controller allows this state to be inverted when necessary. Four common terminals are provided to simplify field wiring.

There is a green LED state indicator for each channel to indicate when a digital input is ON. A green blinking status LED on the module indicates when the module is being scanned. An amber blinking status LED indicates when channels are forced and a red status LED when module diagnostics exist.

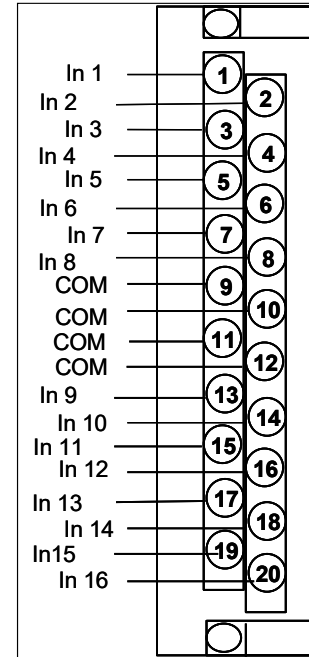

Inputs per module	16 (single-ended)
Voltage Supplied by controller	15 VDC nominal
Maximum contact resistance	1000 ohms
Galvanic Isolation	Isolation - Between Field wiring (input or output) and Module (Microcontroller or Backplane).
OFF to ON response time*	4 ms max
ON to OFF response time*	6 ms max
Switching current	2.6 mA nominal
Power supply loading	5V ; 130 mA max 24V ; 40 mA max

*excluding controllers scan time and excluding transmission time from module to backplane

Digital Input Module - DC Voltage type (900G02-xxxx)

The DC Digital Input module provides two groups of 8 inputs, each with a pair of terminals for connection to common. DC power applied between the common terminal and an input cause the input to turn ON. There is a green LED state indicator for each channel on the module to indicate when a digital input is ON. A green blinking status LED on the module indicates when the module is being scanned. An amber blinking status LED indicates when channels are forced and a red status LED when module diagnostics exist. Logic in the controller allows the state to be inverted when necessary.

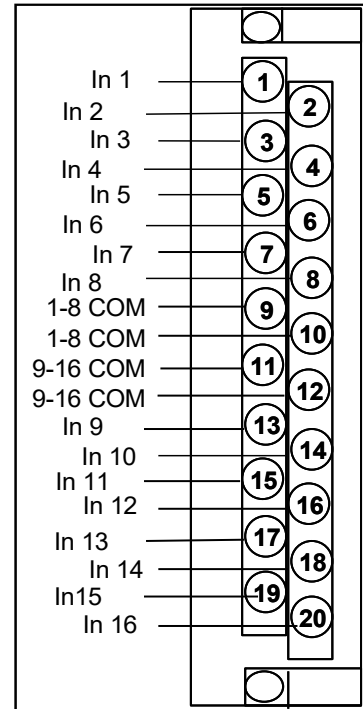

Inputs per module	16 (sinking)
Input Voltage Range	10 VDC to 32 VDC
Peak Voltage	32 VDC
AC Frequency	N/A
Galvanic Isolation	2 groups of 8 inputs (42.4VDC max.)
ON Voltage Level	9.5 VDC minimum
OFF Voltage Level	3.5 VDC maximum
Input Impedance	2.6 K ohms nominal
Input Current	2.3 mA @ 12 VDC 6.9 mA @ 24 VDC nominal
Minimum ON Current	1.0 mA
Maximum OFF Current	0.7 mA
OFF to ON response time*	4 ms max
ON to OFF response time*	4 ms max
Power Supply Loading	5V; 130mA max 24V; 0mA

*excluding controllers scan time and excluding transmission time from module to backplane

Digital Input Module – AC Voltage type (900G03-xxxx)

The AC Digital Input modules are externally powered and accommodate two circuit voltages for up to 8 inputs each. Two common terminals are provided for each circuit. AC power applied between the common terminal and an input cause the input to turn ON. There is a green LED state indicator for each channel on the module to indicate when a digital input is ON. Logic in the controller allows the state to be inverted when necessary.

A green blinking status LED on the module indicates when the module is being scanned. An amber blinking status LED indicates when channels are forced and a red status LED when module diagnostics exist.

Inputs per module	16 (sinking)
Input Voltage Range	80 VAC to 264 VAC
Peak Voltage	264 VAC
AC Frequency	47 Hz to 63 Hz
Galvanic Isolation	2 groups of 8 inputs (350VAC max.)
ON Voltage Level	75 VAC
OFF Voltage Level	20 VAC
Input Impedance	48 K ohms nominal
Input Current	1 mA nominal @ 120 VAC, 60 Hz 2 mA nominal @ 230 VAC, 50 Hz
Minimum ON Current	0.3 mA
Maximum OFF Current	0.2 mA
OFF to ON response time*	4 ms + 1.5 line cycles maximum
ON to OFF response time*	4 ms + 2 line cycles maximum
Power Supply Loading	5V; 130mA max 24V; 0mA

Active input De-rating table for ACDI

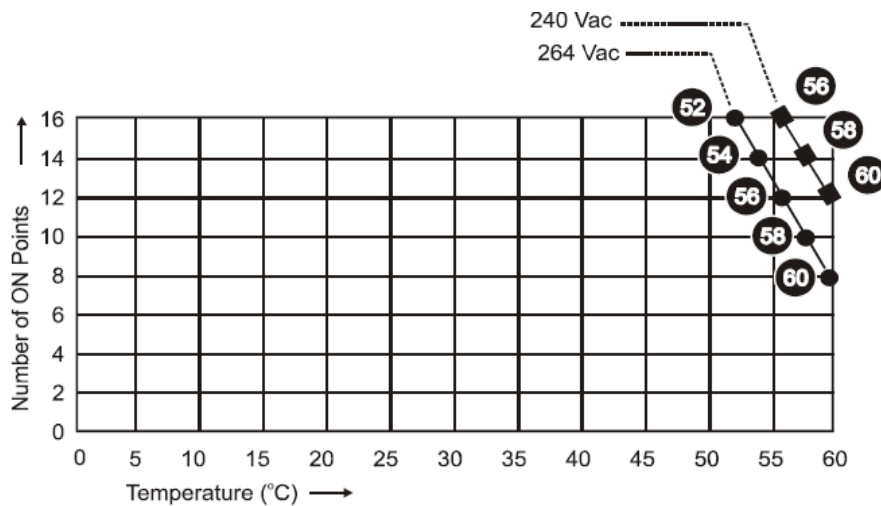
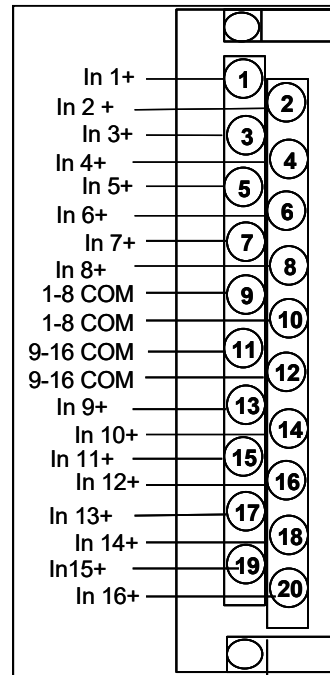

Digital Input Module – AC DC Voltage type (900G04-xxsx)

The AC/DC Input Module provides sixteen individually isolated, inputs that are powered externally. Two terminals are provided for each circuit. AC or DC power applied between the input terminals cause the inputs to turn On. There is a green LED state indicator for each channel on the module to indicate when a digital input is ON.

A green blinking status LED on the module indicates when the module is being scanned. An amber blinking status LED indicates when channels are forced and a red status LED when module diagnostics exist.. Logic in the controller allows the state to be inverted when necessary.

Requires Euro style 36-terminal terminal block.

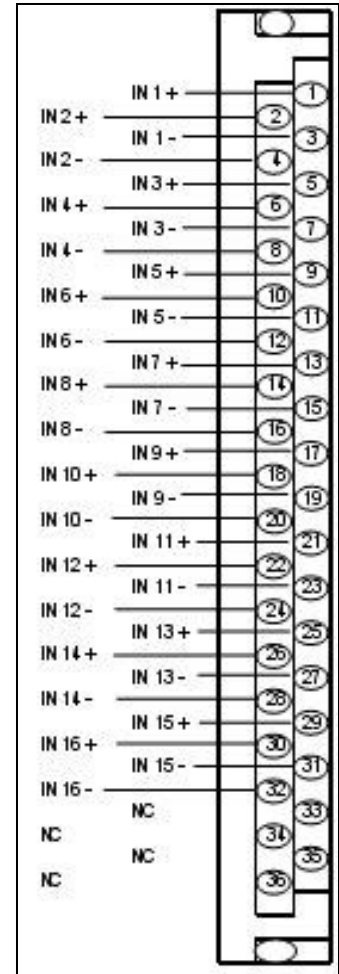

Parameter	AC Application	DC Application
Inputs per Module	16	16
Input Voltage Range	80 VAC to 264 VAC	80 VDC to 125 VDC
Peak Voltage	264 VAC	150 VDC
AC Frequency	47 Hz to 63 Hz	NA
Galvanic Isolation	Input to Input & Input to Chassis (350VAC max)	Input to Input & Input to Chassis (350VAC max)
On Voltage Level	75 VAC	75 VDC
Off Voltage Level	20 VAC	30 VDC
Input Impedance	48 k ohms nominal	48 k ohms nominal
Input Current	1 ma nom. @120 VAC, 60 Hz 2 ma nom. @240VAC, 50 Hz	2 ma nom. @125 VDC
Minimum On Current	0.3 mA	0.3 mA
Maximum Off Current	0.2 mA	0.2 mA
Off to On response time*	6 ms + 1.5 line cycles max.	6 ms + 2 line cycles max.
On to Off response time*	6 ms + 2 line cycles max.	6 ms + 2 line cycles max.
Power Supply Loading	5 V, 130 mA max. 24V 0 mA.	5 V, 130 mA max. 24V 0 mA.

* Nominal times excluding controllers scan time and excluding transmission time from module to backplane. DC application must include controller line filter setting of 50/60 Hz Active input De-rating table for AC/DC DI

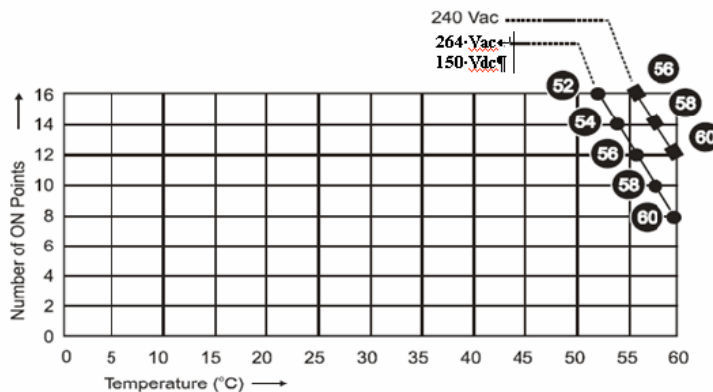

32 Point Digital Input Module - DC Voltage type (900G32-xxxx)

The DC Digital Input module provides 32 inputs separated in to 2 groups of 16 channels each. Each group has a pair of screw terminals for the COM connection. DC power applied between the common terminal and an input cause the input to turn ON. There is a green LED state indicator for each channel on the module to indicate when a digital input is ON. A green blinking status LED on the module indicates when the module is being scanned. An amber blinking status LED indicates when channels are forced and a red status LED when module diagnostics exist. Logic in the controller allows the state to be inverted when necessary.

Requires Euro style 36-terminal terminal block

Inputs per module	32 (sinking)
Input Voltage Range	10 VDC to 32 VDC
Peak Voltage	32 VDC
AC Frequency	N/A
Galvanic Isolation	2 groups of 16 inputs (30VDC max.)
ON Voltage Level	9.5 VDC minimum
OFF Voltage Level	3.5 VDC maximum
Input Impedance	6.9 K ohms nominal
Input Current	1.7 mA @ 12 VDC 3.5 mA @ 24 VDC nominal
Minimum ON Current	1.0 mA
Maximum OFF Current	0.7 mA
OFF to ON response time*	5 ms max
ON to OFF response time*	5 ms max
Power Supply Loading	5V; 215mA max 24V; 0mA

*excluding controllers scan time and excluding transmission time from module to backplane

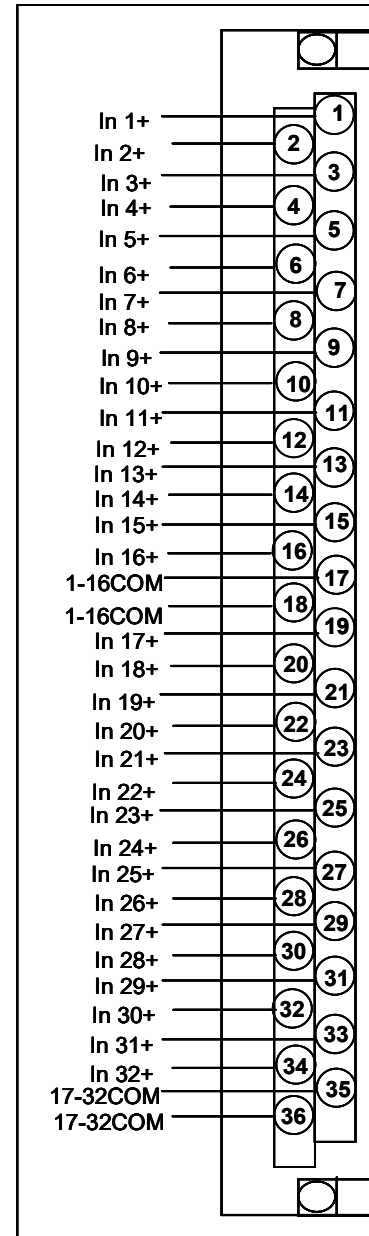

Relay Output Module (900H01-xxxx)

PRECAUTION: A circuit that will be carrying a current continuously for long periods without relay switching operation (circuits for emergency lamps, alarm devices and error inspection that, for example, revert only during malfunction and output warnings with form B contacts). Continuous, long-term current to the coil will facilitate deterioration of coil insulation and characteristics due to heating of the coil itself. For circuits such as these, please use a magnetic-hold type latching relay. If you need to use a single stable relay, use a sealed type relay that is not easily affected by ambient conditions and make a failsafe circuit design that considers the possibility of contact failure or disconnection.

The Relay Output Module provides eight individual galvanically isolated, electromechanical relay outputs. Four of the outputs are Form-C, and the other four are Form-A. Outputs are not fused in the Relay module. Install a fuse for each output at the field device that is appropriate for the load and the wire used.

There is a green LED state indicator for each channel on the module to indicate when a digital output is ON.

A green blinking status LED on the module indicates when the module is being scanned. An amber blinking status LED indicates when channels are forced and a red status LED when module diagnostics exist.

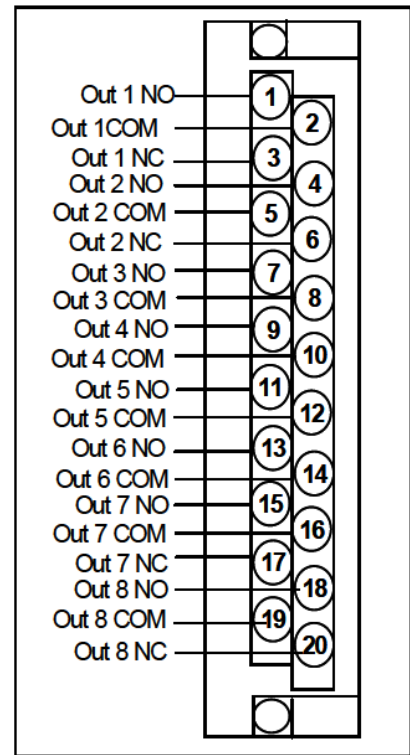

8 Relays per module	4 form A, 4 form C
Output Device	Electromechanical relay
Voltage	120/240 VAC, 30 VDC
Current Rating	4A @ 240VAC or 30VDC resistive load 0.5 A @ 240VAC or 30VDC incandescent lamp load
Galvanic Isolation	Relay Output Contact to Relay Output Contact Relay Output Contact to Logic
Max. Leakage Current	1 mA @ 350 VDC
De-rating	Max. outputs at max. load – none Max. modules per rack - none
OFF to ON response time*	11 ms max
ON to OFF response time*	8 ms max
Power Supply Loading	5V; 110mA max 24V; 100mA max
Expected life (min. operations)	Mechanical at 180 cpm: 5 x 10E7 Electrical: 10E5

*excluding controllers scan time and excluding transmission time from module to backplane

Life expectancy curves (1a1b type)

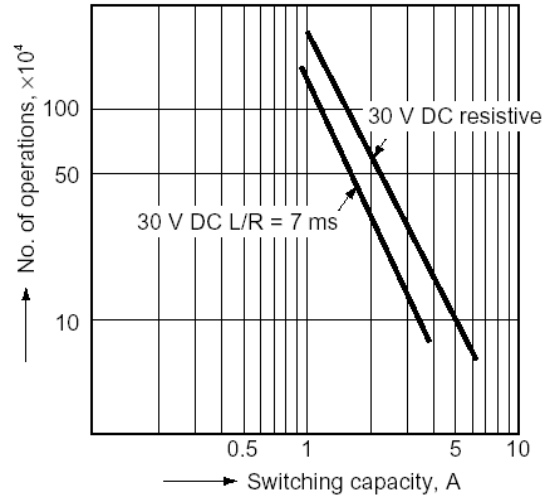
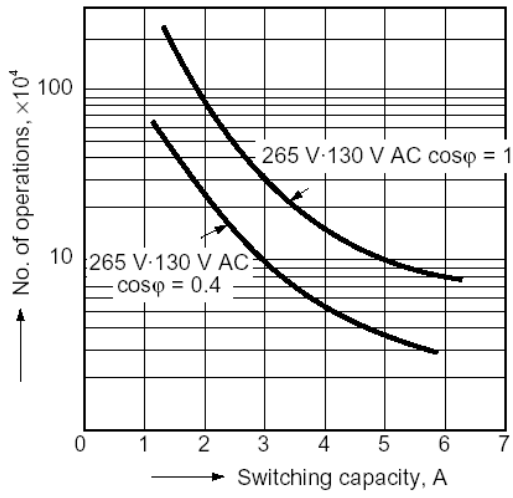

Digital Output Module – DC Type (900H02-xxxx)

The DC Digital Output module provides 16 outputs separated in to 2 groups of 8 channels each that are powered externally. Each group has a pair of screw terminals for +V and COM connections. The outputs are low side switching (current sinking) type. Overload protection is built into each output; when tripped the power must be recycled to reset the module.

There is a green LED state indicator for each channel on the module to indicate when a digital output is ON.

A green blinking status LED on the module indicates when the module is being scanned. An amber blinking status LED indicates when channels are forced and a red status LED when module diagnostics exist..

Outputs per module	16 (current sinking, low side)
Galvanic Isolation	2 groups of 8 outputs
Operating Voltage	6.5 to 32 VDC (5.0 to 6.5 V @ <0.5A per channel)
Output Type	Intelligent power switch (IPS)
Peak Voltage	34 VDC
AC Frequency	N/A
ON Voltage Drop	0.3VDC @ 1 A load
Overload Protection	Electronic high current and high temperature limiting, resets after cycling field power
Maximum Load Current	1 A per point, 8A max. per module, resistive load 0.5 A per point incandescent lamp load (5 mH max)
Maximum Leakage Current	0.15mA @ 32 VDC
Maximum Inrush Current	4 A for 10 ms
Minimum Load	0.0 mA
OFF to ON response time*	6 ms
ON to OFF response time*	6 ms
Fuses	Electronic limiting
Power Supply Loading	5V; 340mA 24V; 0mA

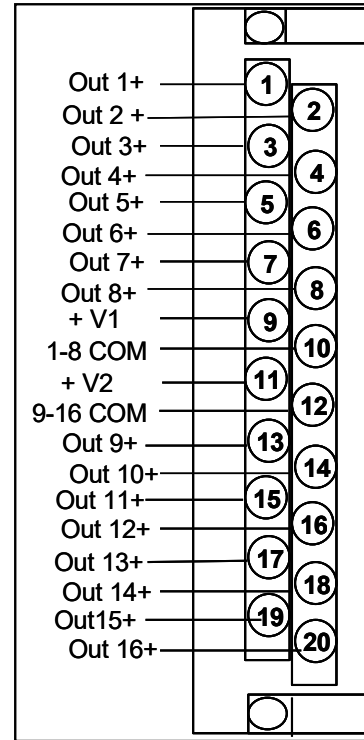

*excluding controllers scan time and excluding transmission time from module to backplane

Digital Output – AC Type (900H03-xxxx)

The AC Digital Output module provides 8 isolated zero switching Triac solid-state outputs. A shorting comb is available for use with barrier type terminal blocks to simplify connections to a common voltage source for all outputs. Each output has a MOV for transient over-voltage protection and a field-replaceable fuse.

There is a green LED state indicator for each channel on the module to indicate when a digital output is ON.

A green blinking status LED on the module indicates when the module is being scanned. An amber blinking status LED indicates when channels are forced and a red status LED when module diagnostics exist.

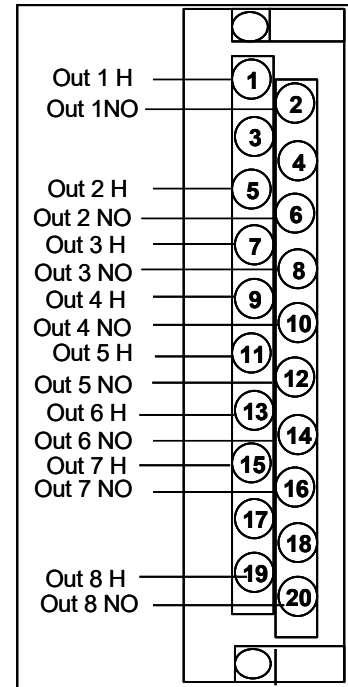

Outputs per Module	8
Galvanic Isolation	Per output to output, output to logic
Operating Voltage	85 VAC to 240 VAC
Output Type	Triac (zero switching voltage)
Peak Voltage	250 VAC
AC Frequency	47 Hz to 63 Hz
ON Voltage Drop	<2.0 VAC (>0.1 A) <3.0 VAC (<0.1 A)
Transient Over voltage Protection	MOV
Maximum Load Current	2 A per point, 8 A max. per module, resistive load
Maximum Leakage Current	4 mA (240 VAC, 60 Hz) 1.2 mA (100 VAC, 60 Hz) 0.9 mA (100 VAC, 50 Hz)
Maximum Inrush Current	15 A for 10 ms
Minimum Load	50 mA
OFF to ON response time*	3 ms + 0.5 line cycle max
ON to OFF response time*	3 ms + 0.5 line cycle max
Fuses	1 per output, 3.15 A Time-lag. Replacement part: Littelfuse 37413150410
Power Supply Loading	5V; 220mA max 24V; 0mA

*excluding controllers scan time and excluding transmission time from module to backplane

32 Point Digital Output Module – DC Type (900H32-xxxx)

The DC digital Output module provides 32 outputs separated in to 2 groups of 16 channels each that are powered externally. Each group has a pair of screw terminals for +V and COM connections. The outputs are high side switching (current sourcing) type. Over current protection is provided for all outputs in 4 groups of 8 channels each. In case of short circuit for any output channel, that whole group of 8 is switched off. Power cycling is not required to reset the module.

There is a green LED state indicator for each channel on the module to indicate when a digital output is ON.

A green blinking status LED on the module indicates when the module is being scanned. An amber blinking status LED indicates when channels are forced and a red status LED when module diagnostics exist. Requires Euro style 36-terminal terminal block.

Maximum Leakage Current	0.15mA @ 32 VDC
Maximum Inrush Current	2 A for 10 ms
Minimum Load	0.0 mA
OFF to ON response time*	6 ms
ON to OFF response time*	6 ms
Fuses	Electronic limiting
Power Supply Loading	5V; 235mA 24V; 0mA

*excluding controllers scan time and excluding transmission time from module to backplane

Outputs per module	32 (current sourcing, high side). Note: Outputs 17 through 32 may not be used for TPO (Time Proportioning Output), PPO (Position Proportioning Output) or TPSC (Three Position Step Output) output types.
Galvanic Isolation	2 groups of 16 outputs
Operating Voltage	10.5 to 32 VDC
Output Type	High side driver
Peak Voltage	32 VDC
AC Frequency	N/A
ON Voltage Drop	0.15 VDC @ 0.5 A load
Overload Protection	Active Current Limiting is integrated into the output driver as 4 groups of 8 channels each. Power cycling is not required to reset the module after a fault condition.
Maximum Load Current	0.5 A per point, 6 A max per channel group 12 A max. per module, resistive load 0.25 A per point incandescent lamp load (5 mH max)

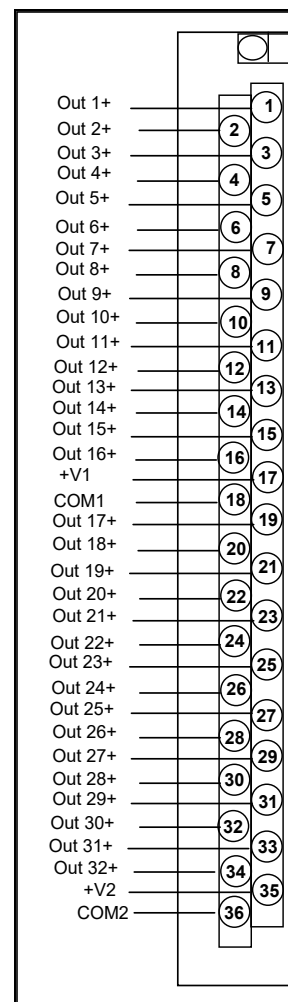

4 Channel Pulse/Frequency/Quadrature Module - DC Voltage type (900K01-xxxx)

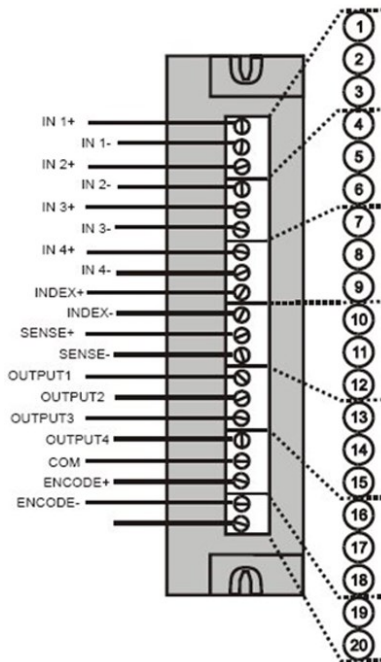

Note: For Quadrature input Differential mode, connect wires using reverse polarity (+ to -) on Input 1, Input 2 and Index.

The 4 Channel Pulse/Frequency/Quadrature Module provides four different functionalities in the form of Pulse Input, Frequency measurement, Quadrature encoder input and Pulse Output. Each of these channels can be configured for any one of these four functions; with the exception that quadrature encoder input (A and B pulses) can be applied to only Channels 1 and 2 respectively. When configured for quadrature, the other two channels will still be available for use. The Pulse Output functionality uses the digital output available on the module for outputting pulses.

A green blinking status LED on the module indicates when the module is being scanned. An amber blinking status LED indicates when channels are forced and a red status LED when module diagnostics exist.

Input Voltage Range	0 VDC to 24 VDC
Inputs per module	4
Outputs per module	4
Digital Output type	Open collector, 5 to 24V, 30mA max, used for fast signaling
Power Supply Loading	5V; 110mA max 24V; 250mA max (with Encoder) 24V; 100mA max (without Encoder)

Pulse Input Specifications

Input Voltage Range	0 VDC to 24 VDC
ON Voltage Level	3.0 VDC minimum
OFF Voltage Level	1.0 VDC maximum
Input Impedance	25K ohm
Frequency	10 KHz maximum
Minimum Pulse Width	3 μ sec
Pulse Counter	32 bits
Preset Value	User may configure a preset count value within the range of 32 bit counter
Preset Action	Settable as ON or OFF in HC Designer
Digital Output	If preset action ON, output turns ON for 1 second. If preset action OFF, output latches ON, and remains ON until counter reset command.
Counting based on Preset	When the count equals preset value: <ul style="list-style-type: none"> If preset action ON, counter is reset and immediately resumes count. If preset action OFF, counter is not reset and counts beyond preset value.
Counter HOLD	When the HOLD input to the pulse input function block is ON in HC Designer, the counter holds its current value.
Counter RESET	The counter may be reset only via its function block in HC Designer, when an OFF to ON transition occurs on the ^RST input in Monitor mode.
Counter Flags	The OVERFLOW flag gets set when the module counter overflows. This flag can be reset only with the ^CLFG command sent through HC Designer. Also, the PREI flag is set when the digital output of the module turns ON.

4 Channel Pulse/Frequency/Quadrature Module - DC Voltage type (900K01-xxxx) (cont'd)

Frequency Input Specifications

Input Voltage Range	0 VDC to 24 VDC
ON Voltage Level	3.0 VDC minimum
OFF Voltage Level	1.0 VDC maximum
Input Impedance	25K ohm
Frequency	10 Hz minimum 100 KHz maximum
Minimum Pulse width (frequency ranges)	Settable only through HC Designer: 500 µsec (10 Hz to 500 Hz) 50 µsec (10 Hz to 5 KHz) 2.5 µsec (10 Hz to 100 KHz)
Digital Output	ON if input frequency out of range, else OFF

Quadrature Input Specifications

Channels Used	Only channels 1 and 2 can be used for quadrature pulses A and B respectively. Index pulse is provided in addition.
Input Voltage Range	Differential: -6 VDC to +6 VDC Single-ended: 0 VDC to 24 VDC
ON Voltage Level	Differential: 0.2 VDC minimum Single-ended: 3.0 VDC minimum
OFF Voltage Level	Differential: -0.2 VDC maximum Single-ended: 1 VDC maximum
Common Mode Voltage	+/- 12VDC
Input Sensitivity	+/- 200mV
Hysteresis	+/- 50mV
Module powered encoder	5V DC, 0.50A
Frequency	200 KHz maximum
Minimum Pulse Width	2.25 µsec
Quadrature Counter	32 bits signed
Quadrature Modes	For variable resolution there are three count modes for the Pulse/Quadrature input: X1: rising edges of signal A are counted (increment); falling edges of signal A (decrement) X2: rising & falling edges of signal A are counted X4: rising & falling edges of signals A & B are counted
Quadrature LEDs	Two LEDs indicate UP and DOWN direction of counting.

4 Channel Pulse/Frequency/Quadrature Module - DC Voltage type (900K01-xxxx) (cont'd)**Pulse Output Specifications**

Channels Used	Any one of the channels can be used for Pulse Output. However, the use of a particular channel for outputting pulses will render the particular input channel unusable for either of pulse, frequency or quadrature input.
Digital Output Type	Open Collector, 5 to 24V, 30 mA max
Frequency Range	25 Hz – 10 KHz
Duty cycle	Always 50%
Pulse Output Duration	Selectable CONTINUOUS or NUMBERED PULSES.

Safety Universal Input /Output Module (900U02-xxx)

CAUTION: For I/O redundancy, prefabricated cable length from RTP to Redundant UIO modules must be same.

Each channel of the module can be soft configured as AI, AO, DI or DO. Features supported by UIO are:

- Channels soft configurable as AI, AO, DI or DO (All channel are sourcing type)
- SOE (Sequence of Events) with resolution of 1 mS (supported only in non-redundant UIO configuration).
- Simplified wiring for SIL-2 applications due to single module solution

Note: The SIL-2 UIO has inbuilt advanced diagnostics such as, SIL certified microcontroller and critical voltage monitoring. Due to its higher reliability, for SIL-2 UIO there is no need to do 2oo1 or 2oo3 for wiring of IOs for SIL-2 application. For more details refer safety manual (51-52-25-153) and PFD calculation sheet

- Line Monitoring for all configurations
- Short circuit protection for DO
- Per channel Safety Shutdown eliminates need for external master relay
- *HART Supported
- * Single or Redundant Power Capability to Module

A green blinking status LED on the module indicates when the module is being scanned. A red status LED when module or channel diagnostics exist.

For channels configured as Digital input a closed external circuit causes current flow from UIO to establish an ON state. Logic in the controller allows this state to be inverted when necessary.

Analog outputs can only be configured on channels 9 to 16. The Analog Output provides 4 to 20 mA outputs that may be scaled by the user to any span within this range on a per output basis.

Digital Outputs provide over current protection .. In case of short circuit for any output channel, that channel is switched off. Power cycling is not required to reset the module.

For channels which are configured as output (AO/DO) a user specified failsafe value is supported to allow predictable operation in the event of a communication loss between controller and IO module.

Requires 20 pin-terminal terminal block.

Note: Field calibration is not required for UIO channels.

* HART functionality is not supported for Channel 6 of UIO module with hardware revision below D.

The module hardware revision can be found on the backside (light pipe side) of the UIO module.

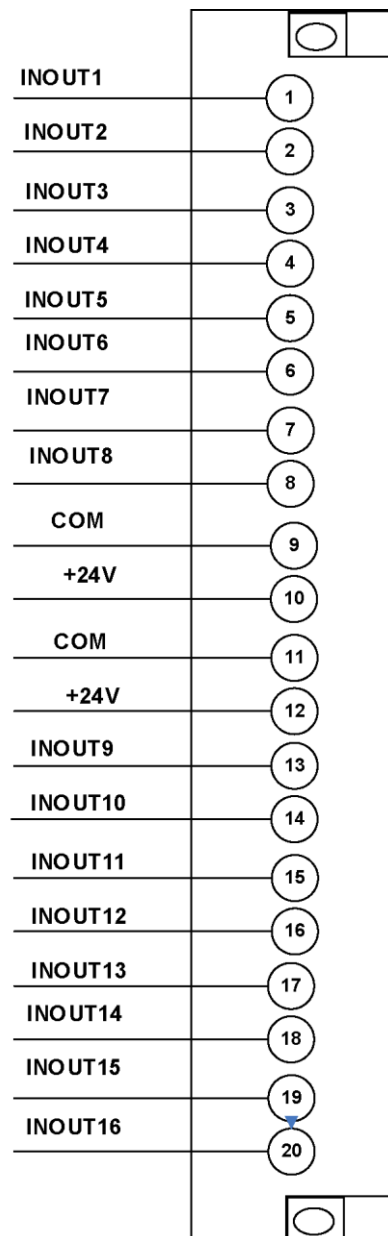

Universal IO channel can be soft configured as AI, AO, DI or DO. Details of each IO type are listed in tables below.

Item	Specification
Channels	Non-redundant UIO configuration: 16 ¹ Channels Redundant UIO configuration: 14 Channels
24V Field Supply Voltage	24V DC(Typical) ^{2,3} 22V DC(Min) 27V DC(Max)
Load	Max 4.2 Amps per module 500 mA per channel
Isolation	1.5 kVDC Module to Rack (Logic Side) 1.5 kVDC Module to Module
Update Rate	10ms
ESCP (Electronic Short Circuit Protection per channel)	620 mA re-settable
Fuse (per channel)	Internal, non-replacable (1 Amp)
Field Supply Fuse	Internal, electronic fuse (10 Amps)

Detail Specifications – Analog Input

Parameter	Specification
Input type	Current (2, 3, or 4 wire devices). Sink type input transmitters are supported. HART supported.
Input Channels	16 Maximum per module (line monitored)
A/D Converter Resolution	16 Bit
Input Range	4-20 mA (cut-off limits: 3-22 mA)
Crosstalk, dc to 60 Hz (channel-to-channel)	58dB
Input Impedance	250 Ω nominal
Maximum Input Voltage (any input referenced to common, no damage)	0 - 30V
Hardware accuracy	0.1% of full-scale (23.5 \pm 2°C) 0.2% of full-scale (23.5 \pm 2°C) (For Redundant) 0.17% of full-scale (0 to +60°C) 0.34% of full-scale (0 to +60°C) (For Redundant)
Transmitter Field Power Conditioning	Current limited to 24 mA
Input Filter	First-order low-pass 1 kHz

Detail Specifications – Analog Output

Parameter	Specification
Output Type	4-20 mA current loop. HART supported.
Output Channels	8 Maximum per module ¹ (with line monitoring) Assignable as channels 9 to 16
Accuracy	<0.5% of Full Scale (25°C) including linearity, entire operating temperature. <1% of Full Scale (25°C) including linearity, entire operating temperature (for Redundant).
Output Ripple	=< 125 mV peak-to-peak at power line frequency, across 250 Ohm load
Output Readback Accuracy	0.17% of full scale
Output Current Linearity	\pm 0.1% of Full Scale nominal
Resolution	12 Bit
Directly Settable Output Current Range	2.4 mA to 21 mA
Maximum Resistive Load	750 ⁴ Ohms
Minimum Resistive Load	250 Ohms
Maximum Output Compliant Voltage (24 V supply = 22 VDC through 28 VDC)	14 VDC
Maximum Open Circuit Voltage	24 VDC
Maximum Load capacitance	< 1 μ F

Detail Specifications – Digital Input with Open Wire Detection (OWD)

Parameter	Specification
Open Voltage	24V
Short Circuit Current	7 mA
Open Contact	15 k Ω > 0.1 W ^A
Closed Contact	5 k Ω > 0.25 W ^B
Short circuit detection	I > 6 mA +/- 5 %
Closed contact detection	2.8 mA < I < 6 mA +/- 5 %
Open contact detection	0.9 mA <= I <= 2.8 mA +/- 5 %
Lead Breakage Detection	I < 0.9 mA +/- 5 %
Input filter	First-order low-pass 1 kHz
Note A: At 24 VDC, equates to 8.57 K Ω > R > 4 K Ω (where R = total loop resistance)	
Note B: At 24 VDC, equates to 26.7 K Ω > R > 10 K Ω	

Detail Specifications – Digital Input without Open Wire Detection (OWD)

Parameter	Specification
Open Voltage	24 VDC
Closed contact detection	I > 2.81 mA ^C
Open contact detection	I < 1.8 mA ^D
Input filter	First-order low-pass 1 kHz
Note C: At 24 VDC, equates to R < 8.57 K Ω (where R = total loop resistance)	
Note D: At 24 VDC, equates to 26.7 K Ω > R > 10 K Ω	

Detail Specifications – Digital Output

Parameter	Specification
Output Channels	16 Maximum per module (with line monitoring) ²
Output Type	Solid state source, short circuit protected
Load Current	Redundant Mode - 4mA (min) to 0.5A (max) ⁵ Non-Redundant Mode - 1mA (min) to 0.5A (max) 4.0A Maximum per module
On-State Voltage	24 V (typ), load current @ 0.5 A
Off-State Voltage	0 VDC (max) Open Load
Off-State Leak Current	< 0.1 mA
Maximum Load Inductance	< 10 H
Maximum Load Capacitance	< 1 μ F
Lamp Load	< 3 Watt (Verify Inrush Current requirement of Lamp Load)
Inrush Current	1 A for 10 μ S
DO read back current Accuracy	DO Current : 3-10 mA +/- 1 mA 11-100 mA +/- 5 mA 101-500 mA +/- 20 mA
Short Circuit Protection	Internal Electronic (750 mA)

Note:

- 900U02 modules may not be installed such that the 900U02 is between two 900B16 modules. 900B16 may only be installed in one adjacent slot.
- Field power to be supplied by a local power supply providing tertiary protection from zone B severity levels. Generally characterized by short wiring, isolation, surge suppressors etc.
- For Marine applications ABS Type approved power supplies are required for field supply voltage.
- Field supply voltage should be maintained higher than 22.5 V for AO higher AO loads (> 750 Ohms).
- Redundant Mode - UIO 10mA (min) to 0.5A (Max) for UIO (900U02) firmware version 3.02 and below.

Terminal Blocks (900TEK-xxxx, 900TBK-xxxx, 900TER-xxxx, 900TBR-xxxx)

ControlEdge HC900 I/O modules use terminal blocks with various features available.

Terminals are available in Barrier style and Euro style. The Barrier style terminal block provides a floating washer to accommodate two different size conductors. The Euro style offers a more compact terminal design providing more room within the terminal block cavity for conductors.

All terminal blocks support customer wiring entering the block from the top or bottom when mounted in the controller. A locking swing out door provides easy access for wiring and covers potential high voltage connections during operation.

For low voltage terminals accepting thermocouple inputs, cold junction compensation is provided by the AI modules.

Terminal blocks are secured to the rack assembly with screws. These screws provide vibration immune terminal connections during operation and also serve as jacking screws when removing modules to minimize the extraction force required.

The rear of the Terminal block provides keying to prevent accidental terminal block insertion into incorrect module slots. Labels are provided to identify the module type by name and color, offer wiring instructions and provide an area for customer identification of field circuits. Shorting combs are available for use with Barrier terminal blocks to connect common signal pairs together or to jumper together common signals on AC and Relay output modules.

Shield terminal strips are also available to terminate the shields of shielded cables at the controller.



Sample terminal blocks
(L) 20-terminal high voltage Barrier
(R) 36-terminal Euro

Number of terminals	20	36*
Type	Terminal blocks removable under instrument power. (Field power disconnected)	Terminal blocks removable under instrument power. (Field power disconnected)
Gauge Wires	Barrier and Euro: #14 to 26 AWG, solid or stranded	Euro: #12 to 26 AWG, solid or stranded
Terminal color	High voltage: Red Low Voltage: Black	Black
Contacts	High Voltage: Tin Coated Low Voltage: Gold Plated	Gold plated
Contact Style	Post and socket	Post and socket
Door Access	Tool accessible	Tool accessible
Cold Junction compensation for thermocouples	Yes (provided by AI module)	N/A—thermocouples not used
*Required with the following I/O modules: 16 HL AI, 8 AO, 16 AO, 32 DI, 32 DO and 16 AC/DC DI.		



Terminal styles
(top) Barrier
(middle) Euro
(bottom) 36-terminal Euro

I/O Scanner Module (900S50x-xxxx)

The I/O Scanner 1 module resides in a remote I/O rack along with the I/O modules. The Scanner 1 and the controller are connected to each other's I/O port (see the photo on the right side of this page). The scanner collects data from the Input modules populated in its remote rack and communicates the information to the controller. Output data is sent from the controller to the Scanner 1 module which in turn sends the data to appropriate output module. Data exchanges are synchronous with the controller scan time to maintain deterministic operation. Diagnostic status of I/O modules is also monitored and reported to the controller when detected. The Rack address of a Scanner 1 is set via DIP switches on the Scanner 1's circuit board. Connection to the controller uses IEEE 802.4 Ethernet 100base-TxPhysical Layer. An external Ethernet switch is required when multiple I/O scanners are used with a single controller. Scanner 1 modules do support removal and insertion under power.



Process Scanner (left) Safety Scanner (right)

Type	I/O Scanner
Status indicators	Scanner: Module status Red/Green LED indicates mode or error Expansion I/O port: Green and Yellow LEDs indicate receive/transmit
Power supply loading	5V; 770 mA max

I/O Scanner 2 Module (900S75x-xxxx)

The I/O Scanner 2 module resides in a remote I/O rack along with its I/O in a Redundant Controller System. The Scanner 2 has two I/O connections I/O A is connected to CPU-A and I/O B is connected to CPU-B in the Redundant Controller rack. The scanner 2 collects data from the Input modules populated in its remote rack and communicates the information to the Lead controller. Output data is sent from the Lead controller to the Scanner 2 module which in turn sends the data to appropriate output module. Data exchanges are synchronous with the controller scan time to maintain deterministic operation. Diagnostic status of I/O modules is also monitored and reported to the controller when detected.

The Rack address of a Scanner 2 module is set via switches on the module. Connection to both of the redundant controllers is made using both ports, each conforming uses IEEE 802.4 Ethernet 100base-TxPhysical Layer. An external Ethernet switch is required when multiple I/O scanners are used with a single controller. Scanner modules do support removal and insertion under power.



Process Scanner (left) Safety Scanner (right)

Type	I/O Scanner
Status indicators	Scanner: Red/Green LED indicates mode or error I/O A Port: Green and Yellow LEDs indicate receive/transmit I/O A Port: Green and Yellow LEDs indicate receive/transmit
Power supply loading	5V; 770mA max

Redundant Switch Module (RSM) (900RSM-xxxx)

The Redundant Switch Module resides in a ControlEdge HC900 Redundant controller rack and interfaces with both CPUs of a redundant system and indicates which CPU is functioning as the Lead controller and which is the Reserve. A key switch on the module sets the mode of both the Lead and Reserve controllers, guaranteeing synchronization of CPUs. A momentary contact position of the key switch allows the user to switch the Lead control function from CPU-A to CPU-B or vice versa.

The RSM module supports insertion and removal under power.



Type	Redundant CPU Status and Mode control Module
Lead/Reserve indication	Green arrow LEDs
Mode Switch	Removable key (2 keys supplied) , three stationary positions, one momentary
Power Supply Loading	5V; 22mA max

Power Status Module (PSM) (900PSM-xxxx)

The Power Status Module resides in a local or remote I/O rack containing redundant power supplies. The PSM and second power supply are contained in a rack extension assembly adjacent to the power supply slot position. The PSM module is positioned in a dedicated slot between the two power supplies.

Redundant power and the PSM may be used with a Controller rack with local I/O, a Scanner 1 rack with remote I/O controller racks of non-redundant systems and a Scanner 2 rack with remote I/O racks of redundant systems.

Directional indicators on the module indicate when both voltage sources of the power supply are operating properly.

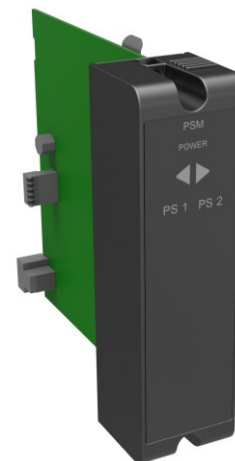

Type	Redundant Power Supply Status indicating Module
Status indication	Green directional indicators using LEDs
Power Supply Loading	5V; 22mA max

Remote Terminal Panels

DIN rail mounted Remote Terminal Panels (RTPs) are available for use with pre-wired cables to reduce installation time and labor expense. Three types of RTPs are available: for analog inputs, for relay outputs, and for other I/O modules. Three cable lengths are also available to match hardware to installation variations. Analog input RTPs include transmitter shunt resistors and transmitter power terminals with individual circuit fuses. The Relay Output RTP includes a fuse and power disconnect switch for each output. All RTP panels switch field power to allow module removal and installation under controller power. All RTPs are qualified as non-interfering for SIL-2 application.

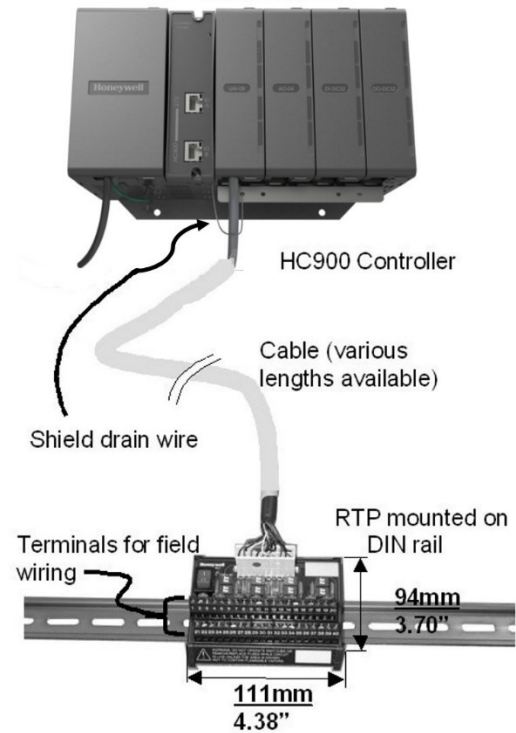

Mounting Standard 35mm wide DIN Rail	Provides connection of field wiring to controller I/O within an enclosure only.
Dimensions	4.38" (111.1 mm) x 3.70" (94.0mm) x 2.60" (66.0mm) (L x W x H)
Cables High voltage	Lengths: 1.0, 2.5, 5.0 meters. Cable power is limited to 24 Amps per module at 60C (140 degrees F) and 32 Amps at 54C (129 degrees F).
Low voltage	Lengths: 1.0, 2.5, 5.0 meters.

Remote Terminal Panel for Analog Input Modules (900RTA-xxxx)

The Analog Input RTP integrates some of the typical externally connected components such as switch selectable shunt resistors for current loops and common power supply terminals with individual fuses for powering two-wire transmitters. A power switch is provided to disconnect power from all transmitters for I/O module maintenance.

The RTP also minimizes the need for multiple wires under a single screw connection by expanding the connectivity of the shared terminals of the I/O module.

The analog input RTP cannot be used for thermocouple inputs.

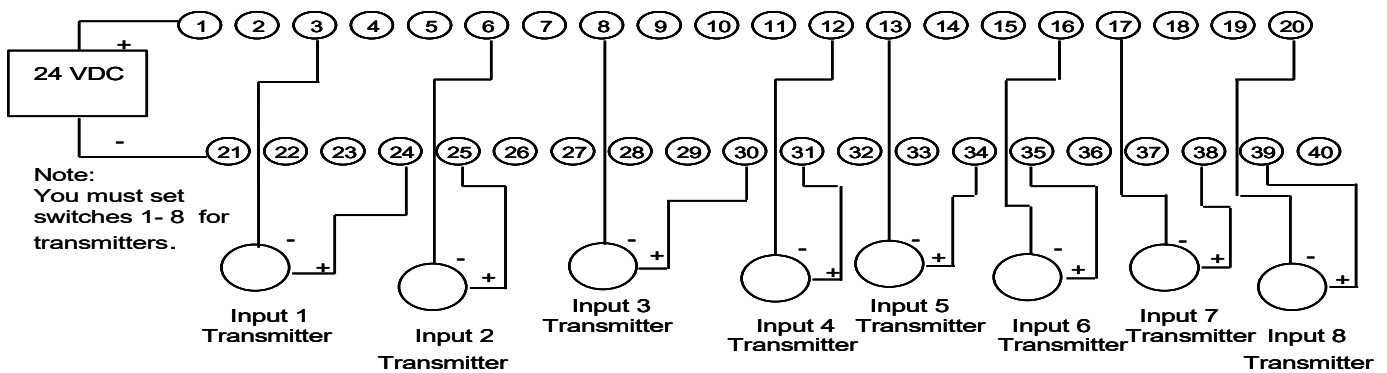
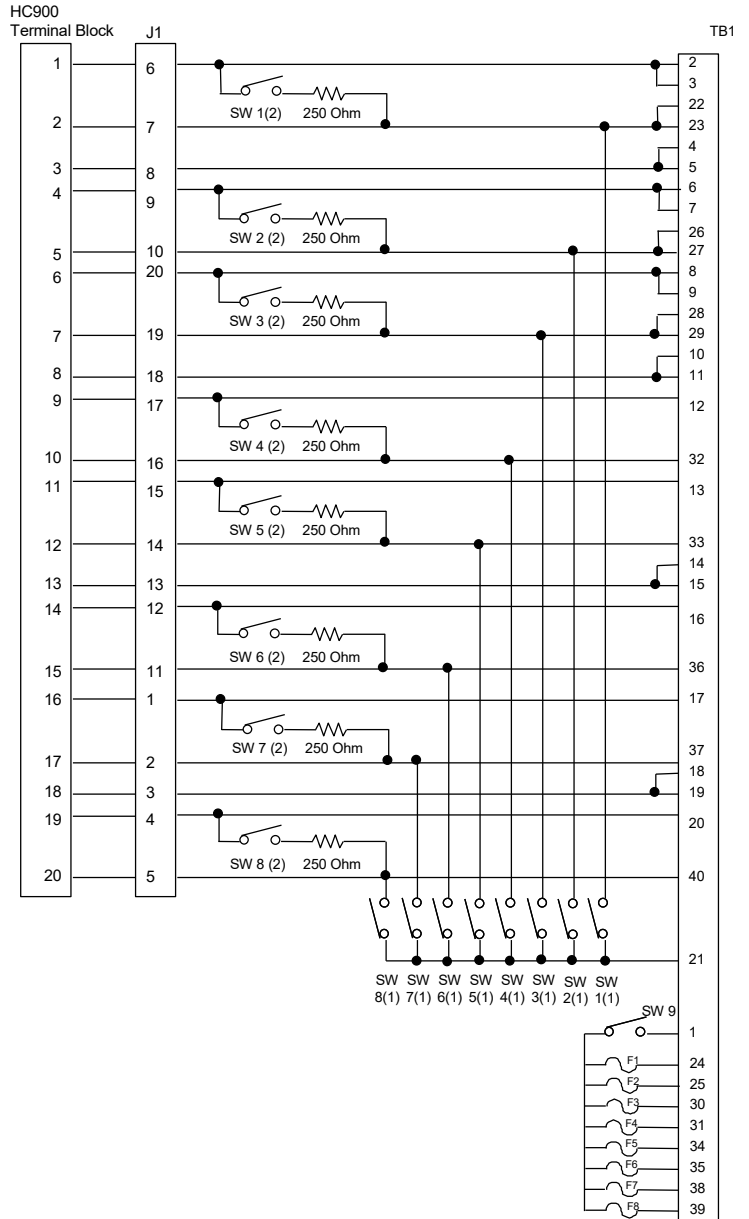

Remote Terminal Panel for Analog Input Modules (900RTA-xxxx) (cont'd)

Analog input Module	Excludes Thermocouple Input types. Accuracy De-rating (Module + RTP) 100 ohm Plat. RTD = +/- 0.14% of range JIS RTD = +/- .22% of range 10 ohm Cu. RTD = +/- .67% of range 200 ohm = +/- 0.17% of range 0 – 10 mV = +/- 0.14% of range
Transmitter power	Common supply terminals – selectable per circuit. Fuse per circuit - 80mA, time lag type
Shunt Resistor	Selectable per circuit 250 Ohms, 0.05% - 15ppm

Remote Terminal Panel for Relay Output Modules (900RTR-xxx)

The RTP for Relay Output modules provides individual fuses for each output. A load disconnect switch is also provided for each output to support maintenance of the relay module under instrument power.

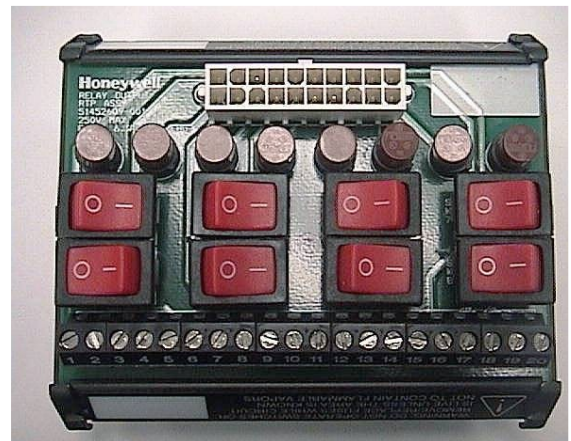
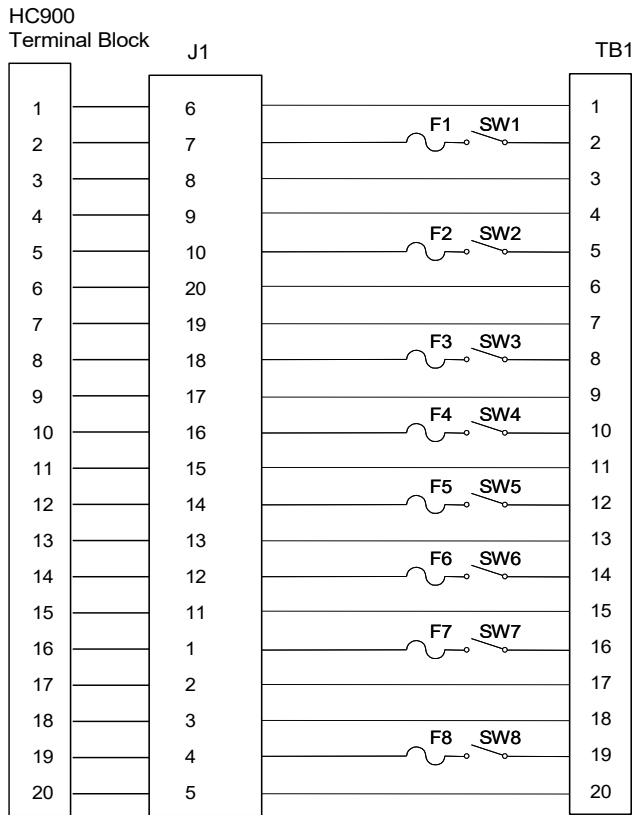

Relay Output RTP	Used with Relay Output Module	Relay common disconnect per circuit Fuse per circuit – 6.3A, time lag type 24A maximum per RTP
------------------	-------------------------------	--

Remote Terminal Panel for Other ControlEdge HC900 Modules (900RTS-xxxx)

Remote Terminal Panel(s) may be used with the following ControlEdge HC900 I/O Modules:

- 16 channel safety UIO module
- 16 Point Digital Input Module, Contact Type
- 16 Point Digital Input Module, AC & DC Types
- 8 Point Digital Output Module, AC type
- 16 Point Digital Output Module, DC type
- 4/8/16 Point Analog Output Module
- 16 Point Digital Input Module, AC/DC types not available

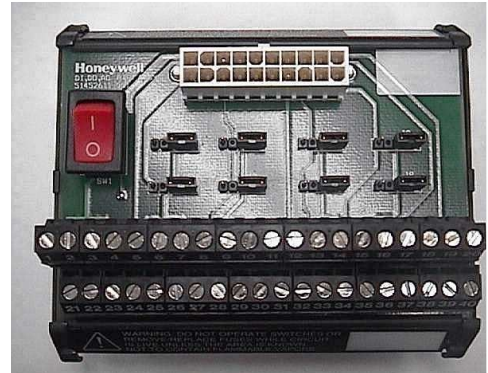

Jumpers on the Remote Terminal Panel may be positioned to accommodate the above input and output modules. A switch on the module is used to disconnect field power from I/O modules to facilitate maintenance of the module under instrument power.

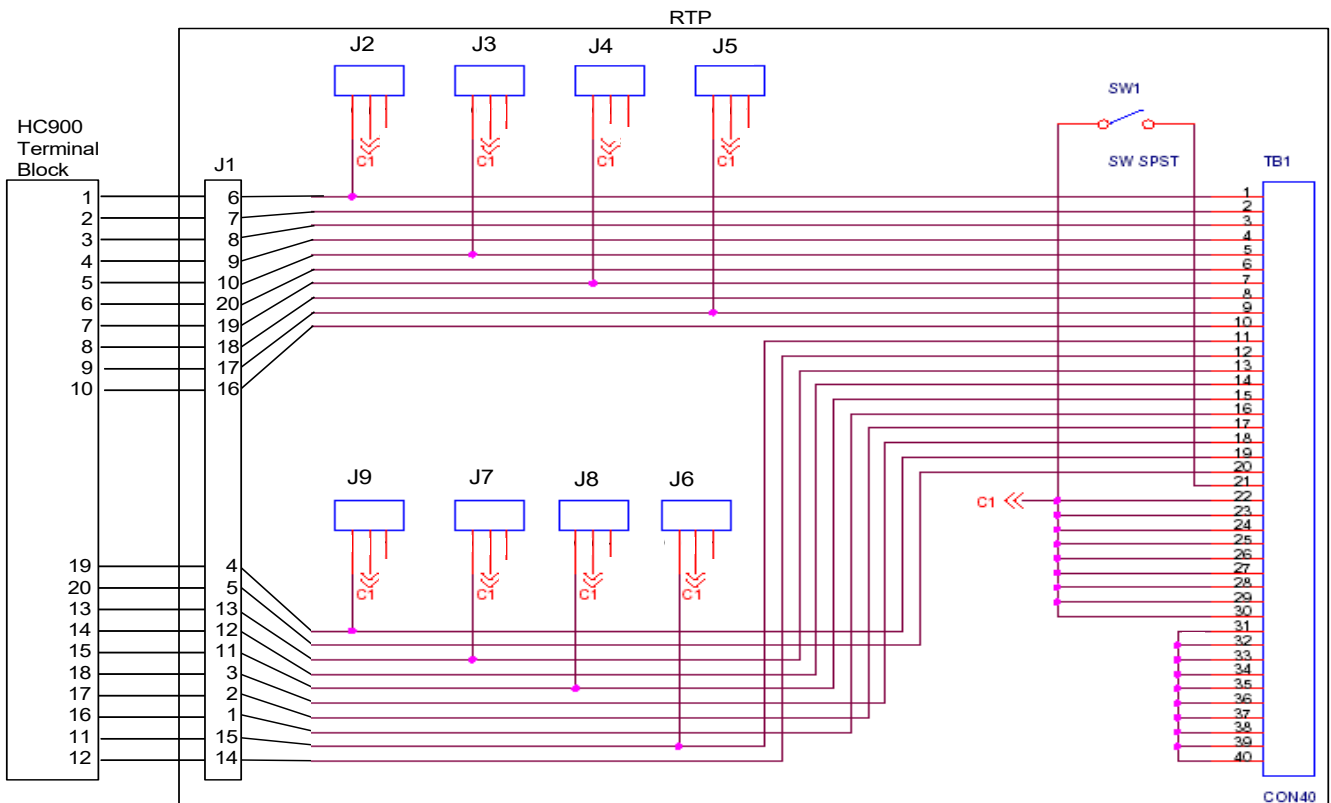

Below table list the relationship between all I/O modules and their related terminal block or RTP:

I/O Module	Terminal Block (Euro)	Terminal Block (Barrier)	RTP	RTP required per module	RTP Cable
900U02-0100 (Non-Redundant)	900TEK-0200	900TBK-0200	900RTS-0001	1	900RTC-H2xx 900RTC-L2xx
900U02-0100 (Redundant)	N/A	N/A	900RTI-0100	1	900RTC-H2xx
900A01-0202	900TEK-0200	900TBK-0200	900RTA-L001	1	900RTC-L2xx
900A16-0103	900TCK-0200	N/A	900RTS-0001	2	900RTC-34xx
900B01-0301	900TEK-0200	900TBK-0200	900RTS-0001	1	900RTC-L2xx
900B08-0202	900TCK-0200	N/A	900RTS-0001	1	900RTC-BAxx
900G03-0202	900TER-0200	900TBR-0200	900RTS-0001	1	900RTC-H2xx
900G32-0101	900TCK-0200	N/A	900RTS-0001	2	900RTC-34xx
900G01-0202	900TEK-0200	900TBK-0200	900RTS-0001	1	900RTC-L2xx
900G04-0101	900TCK-0200	N/A	N/A	N/A	N/A
900H03-0202	900TER-0200	900TBR-0200	900RTS-0001	1	900RTC-H2xx
900H32-0102	900TCK-0200	N/A	900RTS-0001	2	900RTC-34xx
900H01-0202	900TER-0200	900TBR-0200	900RTR-H001	1	900RTC-H2xx
900K01-0201	900TEK-0200	900TBK-0200	N/A	N/A	N/A

UMS-SCA

Below table lists the supported IO hardware of IO modules/SCA modules

IO modules/SCA modules	SIL2 UIO (Redundant)	SIL2 UIO (Non-Redundant)
CC-UPTA01	✓	✓
CC-UGAI01	✓	✓
CC-UGAO01	✓	✓
CC-UGDA01 & CC-UDXA01	✓	✓
CC-UDIR01	✓	✓
CC-UDOR01	✓	✓
CC- UAIA01	✓	✓
CC- UAOA01	✓	✓
FC-UGAI01	✓	
FC-UGAO01	✓	
FC-UGDA01	✓	
FC-UDIR01	✓	
FC-UDOR01	✓	
FC-UDOF01	✓	

Below table list the cable model numbers

SIL2 UIO Non-Redundant	900UMC-T006/900UMC-T010
SIL2 UIO Redundant	900UMC-R006/900UMC-R010

For more details on UMS for ControlEdge Systems, refer guide, "**Installation and User's Guide for Signal Conditioning Assembly**" or **Doc. No. 51-52-25-162**.

Sales and Service

For application assistance, current specifications, pricing, or name of the nearest Authorized Distributor, contact one of the offices below.

ASIA PACIFIC

Honeywell Process Solutions,
(TAC) hfs-tac-support@honeywell.com

Australia

Honeywell Limited
Phone: +(61) 7-3846 1255
FAX: +(61) 7-3840 6481
Toll Free 1300-36-39-36
Toll Free Fax:
1300-36-04-70

China – PRC - Shanghai

Honeywell China Inc.
Phone: (86-21) 5257-4568
Fax: (86-21) 6237-2826

Singapore

Honeywell Pte Ltd.
Phone: +(65) 6580 3278
Fax: +(65) 6445-3033

South Korea

Honeywell Korea Co Ltd
Phone: +(822) 799 6114
Fax: +(822) 792 9015

EMEA

Honeywell Process Solutions,
Phone: + 80012026455 or
+44 (0)1344 656000

Email: (Sales)

FP-Sales-Apps@Honeywell.com

or

(TAC) hfs-tac-support@honeywell.com

AMERICA'S

Honeywell Process Solutions,
Phone: (TAC) 1-800-423-9883 or
215/641-3610
(Sales) 1-800-343-0228

Email: (Sales)

FP-Sales-Apps@Honeywell.com

or

(TAC) hfs-tac-support@honeywell.com

Specifications are subject to change without notice.

For more information

To learn more about ControlEdge HC900 Controller,
visit <https://process.honeywell.com/>
Or contact your Honeywell Account Manager

Process Solutions

Honeywell

3940 Virginia Avenue,
Cincinnati, Ohio 45227

Honeywell Control Systems Ltd
Honeywell House, Skimped Hill Lane
Bracknell, England, RG12 1EB

Shanghai City Centre, 100 Jungi Road
Shanghai, China 20061

<https://process.honeywell.com/>

Honeywell

51-52-03-41
January 2023

©2023 Honeywell International Inc.