

Technical Information

Series 8 Controller and I/O Specification



**S803-150-520**

**Release 520**

**March 2022, Version 1.0**

**Revision History**

Revision	Date	Description
1.0	March 2022	Release version for Experion R520

## Table of Contents

<b>1. Introduction</b>	<b>5</b>
1.1. Overview	5
1.2. Scope	5
1.3. Definitions	5
<b>2. Platform Environmental Specifications</b>	<b>6</b>
2.1. General Environmental Characteristics	6
2.2. Approval Bodies	7
2.3. Detailed Specification- Approvals	8
<b>3. C300 Controller</b>	<b>10</b>
3.1. Overview	10
3.2. Model Numbers	11
3.3. C300 Controller Specifications	11
3.3.1. C300 Control Execution Environment (CEE)	11
3.3.2. C300 Hardware Specifications	11
3.3.3. C300 Supported Function Blocks	13
<b>4. Series 8 I/O Hardware</b>	<b>15</b>
4.1. Overview and Features	15
4.2. I/O Module Functions	16
4.3. Series 8 I/O Sizing	16
4.3.1. Series 8 Field connections	16
4.3.2. I/O Module Sizes	17
4.4. Specifications for Series 8 I/O	18
4.4.1. Analog Input with HART - Differential	18
4.4.2. Analog Input with HART – Single Ended	20
4.4.3. Analog Input – Single Ended	22
4.4.4. Low Level Analog (Temperature) Input LLAI	24
4.4.5. Analog Output with HART	27
4.4.6. Analog Output	29
4.4.7. Digital Input 24VDC	31
4.4.8. Digital Input Sequence of Events	32
4.4.9. Digital Input Pulse Accumulation	33
4.4.10. Digital Output 24VDC	34
4.4.11. DO Relay Extension Board	36
4.5. Series 8 IO Function Matrix	38
<b>5. Series-8 Power Systems and Accessories</b>	<b>39</b>
5.1. COTS Series-8 Power System	39
5.1.1. Notable Features	39
5.1.2. Model Numbers	39
5.1.3. Detailed Specifications- Power System	40
5.2. Header Board	42
5.2.1. Notable Features	42
5.2.2. Model Number	42
5.2.3. Detailed Specifications- Header Board	42

---

5.3.	Circuit Breaker Box Assembly.....	43
5.3.1.	Notable Features .....	43
5.3.2.	Model Number .....	43
5.3.3.	Detailed Specification - Circuit Breaker Box Assembly.....	43
5.4.	C300 Controller memory backup .....	44
5.4.1.	Notable Features .....	44
5.4.2.	Model Number .....	44
5.4.3.	Detailed Specification – RAM Charger Assembly.....	44
5.5.	S8 IO Extension Solutions .....	45
5.5.1.	Model Number .....	45
<b>6.</b>	<b>Glossary .....</b>	<b>46</b>

# 1. Introduction

## 1.1. Overview

This document provides technical information to configure the Experion® Series 8 I/O and the C300 Controller.

## 1.2. Scope

The following Series 8 hardware items are included in this document.

- Series 8 C300 Controller
- Analog Input with HART – Differential
- Analog Input with HART – Single Ended
- Analog Input – Single Ended
- Low Level Analog (Temperature) Input LLAI
- Analog Output with HART
- Analog Output
- Digital Input, 24 VDC
- Digital Input Sequence of Events (SOE)
- Digital Input Pulse Accumulation
- Digital Output, 24 VDC
- DO Relay Extension Board

## 1.3. Definitions

- **Input Output Termination Assembly (IOTA):** An assembly that holds the IOM and the connections for field wiring,
- **Input Output Module (IOM):** A device that contains most of the electronics required to perform a specific I/O function. The IOM plugs onto the IOTA.

## 2. Platform Environmental Specifications

### 2.1. General Environmental Characteristics

This section relates to the physical characteristics applicable to Series 8 C300 controller and all Series 8 I/O components. Where applicable, specifications state limits within an approved cabinet and to the cabinet skin.

Consideration	Operating Limit <sup>1</sup>	Transportation and Storage Limits <sup>1a</sup>
Ambient Temp Range	External: 0 to +50°C <sup>2</sup> Internal: 0 to +60°C <sup>3</sup>	-40 to 85°C
Temp. Rate of Change	<= 1°C/min	<=5°C/min
Relative Humidity <sup>3</sup>	5 to 95% (non-condensing) <sup>4</sup>	5 to 95% (non-condensing) <sup>4</sup>
Barometric Pressure Altitude	-300 to +3000 m	Any
Corrosives	G3 Standard (ISA S71.04) - Denoted by "8C-" model number in this doc	G3 Standard (ISA S71.04) - Denoted by "8C-" model number in this doc
Vibration (3 axes)	Sinusoidal (5 to 10 Hz) 2.54mm/0.100in Max (10 to 150 Hz) 0.5 g max. (0-Pk)	Random Vertical Shipping Axis 5 to 300 Hz 1.07 g (rms) Longitudinal and Transverse 10 to 500 Hz, 0.74 g (rms) 60 Minutes each axis
Mechanical Shock (3 Axes)	Site Induced: Terminal Peak Sawtooth waveform 4g max. @25ms	N/A
<p>Note 1 – Operating Limits define the range of operating conditions within which the system is designed to operate. Performance characteristics are defined when operating in this state. Please see ANSA/ISA D 51.1 Process Instrumentation Terminology for more information.</p> <p>Note 1a – Transportation and Storage Limits define the range of conditions to which the system may be subjected without permanent damage to the equipment. Performance is not guaranteed in this state. Please see ANSA/ISA D 51.1 Process Instrumentation Terminology for more information.</p> <p>Note 2 – This rating applies to the external ambient temperature of the Standard 2000mm enclosure with doors closed.</p> <p>Note 3 – This rating applies to the internal ambient temperature of the Standard 2000mm enclosure with the doors closed.</p> <p>Note 4 – The maximum relative humidity spec applies up to 40°C. Above 40°C the RH spec is de-rated to 55% to maintain constant moisture content.</p>		





#### A note on the transportation of Batteries:

Some Government agencies have regulations that may prohibit air transport of Lithium Batteries.

## 2.2. Approval Bodies

Approval Body	Certification Category	Description
<b>Factory Manual</b>	Division 2 Approvals	All models are approved as non-incendive for use in Class I, Division 2, Group A, B, C, D hazardous (classified) locations.
	Zone 2 Approvals	All models are approved as normally non-sparking apparatus for use in Class I, Zone 2, AEx nA IIC hazardous (classified) locations. Temperature rating of all individual models as well as cabinet configurations is rated T4.
<b>Canadian Standards Association (CSA)</b>	Division 2 Certifications	All models are certified as suitable for use in Class I, Division 2, Group A, B, C, D hazardous locations.
	Zone 2 Certifications	All models are certified as normally non-sparking apparatus, Ex nA IIC, for use in Zone 2 hazardous locations. Temperature rating of all individual models as well as cabinet configurations is not to exceed T4.
<b>ATEX</b>	Zone 2 Certifications	All models are certified as normally non-sparking apparatus, II 3G Ex nA IIC T4 GC, for use in Zone 2 hazardous locations. Temperature rating of all individual models as well as cabinet configurations are rated T4.
<b>IECEX</b>	Zone 2 Certifications	All models are certified as normally non-sparking apparatus, Ex nA IIC T4 GC, for use in Zone 2 hazardous locations. Temperature rating of all individual models as well as cabinet configurations are rated T4.
<b>European Compliance (CE)</b>	EMC, LVD	<ul style="list-style-type: none"> <li>European EMC Directive 2014/30/EU</li> <li>EN 61326-1 2013 Electrical equipment for measurement, control and laboratory use - EMC requirements.</li> <li>European LVD Directive 2014/35/EU</li> <li>IEC/EN 61010-1:2010 Safety Requirements for Electrical Equipment for Measurement, Control and Laboratory Use. Part 1: General Requirements</li> </ul>
<b>Others</b>		C-Tick

## 2.3. Detailed Specification- Approvals

Consideration	Approval
Agency Approvals	     <p><b>Cabinet:</b>            Class I, Division 2, Grp. ABCD, T4            Class I, Zone 2, AEx/Ex nA IIC T4 GC            ATEX II 3G Ex nA IIC T4 GC            IECEx Ex nA IIC T4 GC</p>

Item	Specification																														
CE Conformity	This product is in conformity with the protection requirements of the following European Council Directives: 2014/35/EU, the Low Voltage Directive, and 2014/30/EU, the EMC Directive. Conformity of this product with any other "CE Mark" Directive(s) shall not be assumed.																														
	<b>LVD Directive:</b>																														
	<table border="1"> <thead> <tr> <th>Title</th> <th>Number</th> <th>Issue date</th> </tr> </thead> <tbody> <tr> <td>Safety requirements for electrical equipment for measurement, control, and laboratory use – Part 1: General requirements</td> <td>EN 61010-1</td> <td>2010</td> </tr> </tbody> </table>	Title	Number	Issue date	Safety requirements for electrical equipment for measurement, control, and laboratory use – Part 1: General requirements	EN 61010-1	2010																								
	Title	Number	Issue date																												
	Safety requirements for electrical equipment for measurement, control, and laboratory use – Part 1: General requirements	EN 61010-1	2010																												
	<b>EMC directive:</b>																														
	<table border="1"> <thead> <tr> <th>Title</th> <th>Number</th> <th>Issue date</th> </tr> </thead> <tbody> <tr> <td>Electrical equipment for measurement, control and laboratory use - EMC requirements -- Part 1: General requirements</td> <td>EN 61326-1</td> <td>2006</td> </tr> <tr> <td>Industrial, scientific and medical (ISM) radio-frequency equipment – Electromagnetic disturbance characteristics – Limits and methods of measurement</td> <td>CISPR 11:2009+A1</td> <td>2010</td> </tr> <tr> <td>Electromagnetic compatibility (EMC) – Part 3-2: Limits –Limits for harmonic current emissions (equipment input current ≤ 16A per phase)</td> <td>IEC 61000-3-2</td> <td>2009</td> </tr> <tr> <td>Electromagnetic compatibility (EMC) – Part 3-3: Limits –Limitation of voltage changes, voltage fluctuations and flicker in public low-voltage supply systems, for equipment with rated current ≤ 16 A per phase and not subject to conditional connection</td> <td>IEC 61000-3-3</td> <td>2005</td> </tr> <tr> <td>Electromagnetic compatibility (EMC) – Part 4-2: Testing and measurement techniques – Electrostatic discharge immunity test</td> <td>IEC 61000-4-2</td> <td>2008</td> </tr> <tr> <td>Electromagnetic compatibility (EMC) – Part 4-3: Testing and measurement techniques – Radiated, radio-frequency, electromagnetic field immunity test</td> <td>IEC 61000-4-3:2006 +A1:2007 +A2</td> <td>2010</td> </tr> <tr> <td>Electromagnetic compatibility (EMC) – Part 4-4: Testing and measurement techniques – Electrical fast transient/burst immunity test</td> <td>IEC 61000-4-4</td> <td>2004</td> </tr> <tr> <td>Electromagnetic compatibility (EMC) – Part 4-5: Testing and measurement techniques – Surge immunity test</td> <td>IEC 61000-4-5</td> <td>2005</td> </tr> <tr> <td>Electromagnetic compatibility (EMC) – Part 4-6: Testing and measurement techniques – Immunity to conducted disturbances, induced by radio-frequency fields</td> <td>IEC61000-4-6</td> <td>2008</td> </tr> </tbody> </table>	Title	Number	Issue date	Electrical equipment for measurement, control and laboratory use - EMC requirements -- Part 1: General requirements	EN 61326-1	2006	Industrial, scientific and medical (ISM) radio-frequency equipment – Electromagnetic disturbance characteristics – Limits and methods of measurement	CISPR 11:2009+A1	2010	Electromagnetic compatibility (EMC) – Part 3-2: Limits –Limits for harmonic current emissions (equipment input current ≤ 16A per phase)	IEC 61000-3-2	2009	Electromagnetic compatibility (EMC) – Part 3-3: Limits –Limitation of voltage changes, voltage fluctuations and flicker in public low-voltage supply systems, for equipment with rated current ≤ 16 A per phase and not subject to conditional connection	IEC 61000-3-3	2005	Electromagnetic compatibility (EMC) – Part 4-2: Testing and measurement techniques – Electrostatic discharge immunity test	IEC 61000-4-2	2008	Electromagnetic compatibility (EMC) – Part 4-3: Testing and measurement techniques – Radiated, radio-frequency, electromagnetic field immunity test	IEC 61000-4-3:2006 +A1:2007 +A2	2010	Electromagnetic compatibility (EMC) – Part 4-4: Testing and measurement techniques – Electrical fast transient/burst immunity test	IEC 61000-4-4	2004	Electromagnetic compatibility (EMC) – Part 4-5: Testing and measurement techniques – Surge immunity test	IEC 61000-4-5	2005	Electromagnetic compatibility (EMC) – Part 4-6: Testing and measurement techniques – Immunity to conducted disturbances, induced by radio-frequency fields	IEC61000-4-6	2008
	Title	Number	Issue date																												
	Electrical equipment for measurement, control and laboratory use - EMC requirements -- Part 1: General requirements	EN 61326-1	2006																												
	Industrial, scientific and medical (ISM) radio-frequency equipment – Electromagnetic disturbance characteristics – Limits and methods of measurement	CISPR 11:2009+A1	2010																												
	Electromagnetic compatibility (EMC) – Part 3-2: Limits –Limits for harmonic current emissions (equipment input current ≤ 16A per phase)	IEC 61000-3-2	2009																												
	Electromagnetic compatibility (EMC) – Part 3-3: Limits –Limitation of voltage changes, voltage fluctuations and flicker in public low-voltage supply systems, for equipment with rated current ≤ 16 A per phase and not subject to conditional connection	IEC 61000-3-3	2005																												
	Electromagnetic compatibility (EMC) – Part 4-2: Testing and measurement techniques – Electrostatic discharge immunity test	IEC 61000-4-2	2008																												
	Electromagnetic compatibility (EMC) – Part 4-3: Testing and measurement techniques – Radiated, radio-frequency, electromagnetic field immunity test	IEC 61000-4-3:2006 +A1:2007 +A2	2010																												
Electromagnetic compatibility (EMC) – Part 4-4: Testing and measurement techniques – Electrical fast transient/burst immunity test	IEC 61000-4-4	2004																													
Electromagnetic compatibility (EMC) – Part 4-5: Testing and measurement techniques – Surge immunity test	IEC 61000-4-5	2005																													
Electromagnetic compatibility (EMC) – Part 4-6: Testing and measurement techniques – Immunity to conducted disturbances, induced by radio-frequency fields	IEC61000-4-6	2008																													



	Electromagnetic compatibility (EMC) – Part 4-8: Testing and measurement techniques – Power frequency magnetic field immunity test	IEC61000-4-8	2009
	Electromagnetic compatibility (EMC) – Part 4-11: Testing and measurement techniques – Voltage dips, short interruptions and voltage variations immunity tests	IEC61000-4-11	2004
FM <sup>1</sup>	Electrical Equipment for Use in Hazardous (Classified) Locations, General Requirements	FM 3600	2011
	Non-incendive Electrical Equipment for Use in Class I and II, Division 2 and Class III, Division 1 and 2, Hazardous (Classified) Locations	FM 3611	2004
	Electrical and Electronic Test, Measuring and Process Control Equipment	FM 3810	2005
	Electrical apparatus for explosive gas atmospheres. Part 0: General Requirements	ANSI/ISA-60079-0	2013
	Explosive atmospheres Part 15: Equipment protected by type of protection “n”	ANSI/ISA-60079-15	2012
CSA <sup>1</sup>	Non-incendive Electrical Equipment for use in Hazardous Locations	CAN/CSA C22.2 No. 213 – M1987	1987 (2013)
	Electrical and Electronic Test, Measuring and Process Control Equipment	CAN/CSA-C22.2 No. 61010-1-12	2004
	Electrical apparatus for explosive gas atmospheres. Part 0: General Requirements	CAN/CSA E60079-0	2011
	Explosive atmospheres Part 15: Equipment protected by type of protection “n”	CAN/CSA E60079-15	2012
ATEX <sup>1</sup>	Non-incendive Electrical Equipment for use in Hazardous Locations	CAN C22.2 No. 213 - M1987	1987 (2013)
	Electrical and Electronic Test, Measuring and Process Control Equipment	C22.2 No. 1010.1	2004
	Electrical apparatus for explosive gas atmospheres. Part 0: General Requirements	CAN/CSA E60079-0	2011
	Explosive atmospheres Part 15: Equipment protected by type of protection “n”	CAN/CSA E60079-15	2012
IECEX <sup>1</sup>	Electrical apparatus for explosive gas atmospheres. Part 0: General Requirements	IEC 60079-0	2011
	Explosive atmospheres Part 15: Equipment protected by type of protection “n”	IEC60079-15	2010
<p>Note 1:</p> <ul style="list-style-type: none"> <li>The installer shall provide transient over-voltage protection external to the apparatus such that the voltage at the supply terminal of the apparatus does not exceed 140% of the voltage rating of the equipment.</li> <li>The equipment shall be mounted in an enclosure providing a minimum degree of protection of IP54 in accordance with IEC 60079-15, and in a tool-secured enclosure which meets the requirements of IEC 60079-0 and IEC 60079-15.</li> <li>The equipment shall be used in an area not more than Pollution Degree 2 as defined in IEC 60664-1.</li> </ul>			

## 3. C300 Controller

### 3.1. Overview

The Experion Series 8 C300 controller forms the heart of the Experion control system and deterministically executes control strategies, batch operations, interfaces to local and remote I/O and directly hosts custom programmable applications. The compact controller design does not require any additional Interface / communication modules and all control execution and communications are contained in the controller module.

The C300 controller runs the filed proven, deterministic Control Execution Environment (CEE) which is the core C300 software that provides powerful and robust control for the distributed control system (DCS). The control strategies are configured and loaded to the C300 controller through the Control Builder, an easy and intuitive engineering tool.

The C300 Controller is constructed using the Series 8 form factor that employs an Input Output Termination Assembly (IOTA) and an electronics module which mounts and connects to the IOTA. One C300 Controller module and its IOTA contains all of the control and communication functionalities. The C300 IOTA contains only passive devices such as FTE address switches, FTE cable connectors and I/O Link cable connectors. Figure 1 below depicts the IOTA components.

The C300 Controller may operate in both non-redundant and redundant configurations. Redundant operation require a second identical controller with its own IOTA and connecting redundancy cable. The C300 Controller supports Series 8 I/O modules. Two IO Link interfaces, which are redundant, provide connection between the C300 controller and associated I/O modules. The IO Link interface connectors are on the C300 IOTA.

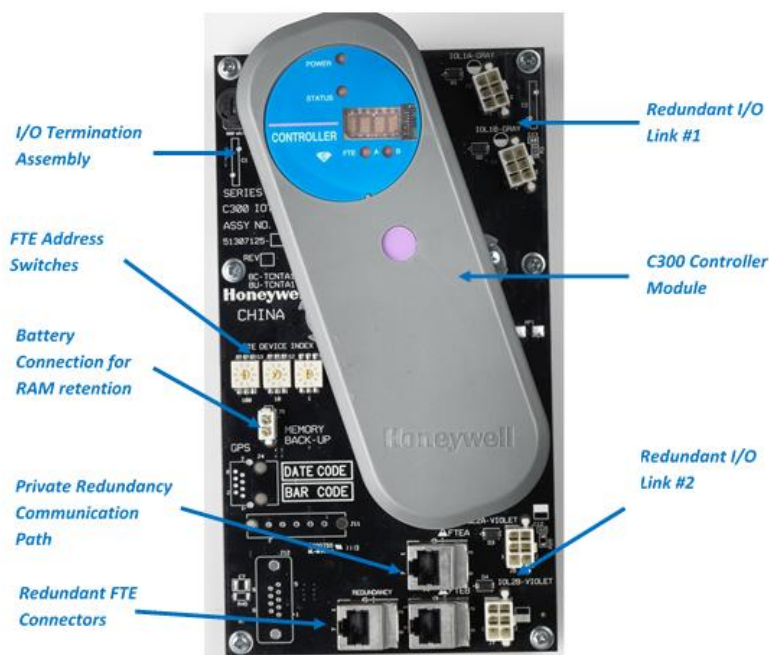

Figure 1 - C300 Controller

## 3.2. Model Numbers

The Model Numbers of C300 controller are shown as below:

Model Number	Description
8C-PCNT03	Series 8 C300 Controller, Coated <sup>1,3,4</sup>
8C-TCNTA1	Series 8 C300 Controller I/O Termination Assembly(IOTA), Coated <sup>1</sup>
51305980-836	Cable, Redundant C300 Controller <sup>2</sup>
Note 1 – Conformal coating applied on the module and the IOTA Note 2 – Redundancy is implemented with two modules/IOTAs and a redundancy cable (51305980-836) Note 3 – Optional rechargeable battery pack for C300 Memory Backup is available, details are provided in section <a href="#">5.4</a> Note 4 – 8C-PCNT02 part number is replaced by 8C-PCNT03. The new controller (8C-PCNT03) is compatible with all current and previous PC/LX releases.	

## 3.3. C300 Controller Specifications

### 3.3.1. C300 Control Execution Environment (CEE)

The C300 CEE provides an execution and scheduling environment in which Control Modules (CMs) and Sequential Control Modules (SCMs) execute user-configured control strategies. The CEE also support peer to peer communications with other C300 controllers and communication modules like Foundation Fieldbus and Profibus. The C300 CEE is configured using the Control Builder Engineering environment. The Control builder provides a graphical engineering environment where engineers can configure the Experion system and create control strategies by using the various function blocks available in the Library. The C300 CEE based control strategies can be configured with minimum execution rates of 50 msec.

### 3.3.2. C300 Hardware Specifications

Specifications	Limit
Power requirement	24 V (provided through cables by the Series 8 power system)
IOTA Dimension	220 mm (9 ") height, 120 mm (4,75 ") width
Program Memory	16MB
Processor	PowerPC 8270, 400 MHz, 32-bit
<b>Features</b>	
Module Removal and Insertion Under Power	Supported
Conformal Coated	Yes, G3 level of Harsh Environment (ANSI/ISAS71.04-1985 corrosion standard)
Redundancy	IOTA based design, no single point of failure for IOM, Termination, and Communication links (Downlink and Uplink)
RAM Retention	50 hour through rechargeable battery backup pack (Optional)

Programing Language	Function Block Design (FBD) via Experion Control Builder
<b>Supported I/Os and Uplink Communication</b>	
Supported I/O type	Series 8
Supported I/O Links	2 I/O Links, each I/O Link configurable for Series 8 I/Os
Supported I/O Link Speed	750 kbps
Supported number of I/O Modules per Controller	80 I/O Units (Redundant or Non-Redundant IOMs)
Supported number of I/O Modules per I/O Link	40 I/O Units (Redundant or Non-Redundant IOMs)
Maximum number of I/Os per Controller	2560 <sup>1</sup>
Number of Uplink (FTE) Connection	Dual uplink FTE ports, 100Mbps speed
<b>Control Capacity</b>	
Execution Units	5500 Execution Units (single or redundant)
Tagged Objects	4095 objects
Memory Units	16000 Memory Units
Execution Period	50 msec – 2000 msec (adjustable per control strategy, configurable)
<b>Controller Communication</b>	
CEE-based Platforms	Native peer to peer with other Series 8 C300s, C200 and ControlEdge UOC controllers <sup>2</sup>
Supervisory Control Network	Fault Tolerant Ethernet (FTE)
Third party devices	Modbus Master
Modbus TCP devices	PCDI function block
Modbus RTU or ASCII	Via Modbus TCP/IP conversion gateway
Ethernet/IP	Native peer to peer
Foundation Fieldbus	Via Fieldbus Interface Module (FIM) gateway
Profibus DP	Via Profibus Gateway Module (PGM)
<b>Optional C300 Memory Backup</b>	
51454475-100	Series 8 C300 RAM Charger Module
51202330-300	Cable, Battery RAM charger, 30 in
51202330-200	Cable, Battery RAM charger, 84 in

Note 1 – When using full capacity with 32 channel digital IO module

Note 2 – C200 and ControlEdge UOC support available from Experion LX/PlantCruise R510 and onwards.

### 3.3.3. C300 Supported Function Blocks

Function Block	Function Block	Function Block	Function Block
<b>General Purpose (Utility)</b>	General	Ramp / Soak	Round
Alarm Window	Linearization	Ratio Bias	Square Root
Annpanel	Lead / Lag	Ratio Control	Subtract
Dig Acq	Rate of Change	Remote Cascade Support	Truncate
EXECTIMER	Signal Selector	Switch (8 input single pole)	<b>Discrete Logic</b>
First Out	Totalizer	<b>Device Control</b>	2oo3 (2 out of 3 voting)
Flag	<b>PV Handling</b>	Device Control (multi input, multi output, multi state)	AND
Flag Array	Data Acquisition	<b>Custom Block Types</b>	CHECKBAD
Operator Message	<b>Regulatory Control</b>	Custom Data Block	CHECKBOOL
Numeric	Auto Manual	Custom Algorithm Block	CHGEXEC
Numeric Array	Regulatory Calculator	<b>Math</b>	CONTACTMON
Push	Enhanced Regulatory Calculator	Absolute Value	DELAY
Text Array	Fan Out (1 input / up to 8 outputs)	Addition	EQ (Compare Equal)
Timer	Override Selector (4 inputs)	Divide	FTRIG (Falling Edge Trigger)
Type Convert	PID (Proportional, Integral, Derivative)	Exponent	GE (Compare Greater than or Equal)
<b>PV Algorithms (Auxiliary)</b>	PID with External Reset	LN	GT (Compare Greater Than)
PV Calculator	PID with Feed Forward	LOG	LE (Compare Less than or Equal)
Summer	Profit Loop	Modulo	LIMIT
Counter	Positional Proportional	Multiply	LT
Dead Time	Pulse Count	Negate	MAX
Enhanced PV Calculator	Pulse Length	Power	MAXPULSE
Enhanced General Linearization		Rolling Average	MIN
Flow Compensation			MINPULSE

Function Block
MUX
MUXREAL
MVOTE
NAND
NE
nOON
NOR
NOT
OFFDELAY
ONDELAY
OR
PULSE
QOR
ROL

Function Block
ROR
RS
RTRIG
SEL
SELREAL
SHL
SHR
SR
STARTSIGNAL
TRIG
WATCHDOG
XOR
Power Related
GRPCAPRBK

Function Block
HTMOTOR
LEVELCOMP
LTMOTOR
MAINIBV
SOLENOID
VALVEDAMPER
Sequential Control Functions
Step
Transition
Synchronize
Handler
Phase

Function Block
Container Block Types
Control Module
Sequential Control Module
Recipe Control Module
Unit Control Module
IO Related
Series 8 I/O
PCDI
Profibus Interface
VCONE

## 4. Series 8 I/O Hardware

### 4.1. Overview and Features

Series 8 features an innovative design that supports enhanced heat management. This unique look provides a significant reduction in overall size for the equivalent function.

Both Series 8 IOM and IOTA are available with Conformal Coated feature. The term 'Coated' stands for hardware with conformal coating material applied to electronic circuitry for protection against moisture, dust, chemicals, and temperature extremes. Coated IOM and IOTA are recommended when electronics must withstand harsh environments and need to have added protection.

The unique features of the Series 8 I/O include:

- I/O Module and field terminations are combined in the same area. The I/O Module is plugged into the IOTA to eliminate the need for a separate chassis to hold the electronics assemblies
- Two level “detachable” terminals for landing the field wiring in the enclosure, providing easier plant installation and maintenance
- Field power can be supplied through the IOTA, with no need for extra power supplies and the associated craft wired marshalling
- Redundancy is available directly on the IOTA without any external cabling or redundancy control devices, by simply adding a second IOM to an IOTA
- The innovative styling is one of its unique features. This styling includes features to facilitate the effective use of control hardware in a systems environment. These features include:
  - Vertical mounting for more effective wiring since most field wiring applications require entry from the top or bottom of the systems cabinet
  - An “information circle” for a quick visual cue to draw the Maintenance Technician’s eye to important status information
  - “Tilted” design for effective heat management within the cabinet enclosure. Since Series C allows for a significant increase in cabinet density, an effective heat management system is critical for high systems availability
  - Input and output circuits are protected from shorts to alleviate the need for in-line fusing, reducing installation and maintenance costs

Series 8 IOTAs combine multiple functions into a single piece of equipment:

- Single and redundant configurations
- On-board termination of process signals
- On-board signal conditioning
- On-board connection to appropriate networks (FTE, I/O LINK)
- Field power distribution without external marshalling
- IOM plugs into the IOTA and receives power from the IOTA
- The IOTA receives its power through cables from header board



## 4.2. I/O Module Functions

- **High Level Analog Input /HART Input Module (16pt)** – The High Level Analog Input Module supports both high level analog and HART inputs. Analog inputs are typically 4-20mA DC for both traditional and HART devices. HART data can be used for status and configuration. HART data, such as the secondary and tertiary variables, can also be used as process control variables. Two versions Single ended and Differential type are available.
- **High Level Analog Input w/o HART (16pt)** – The High Level Analog Input Module supports high level analog inputs Analog inputs are typically 4-20mA DC for traditional devices.
- **Analog Output/HART Output Module (16pt)** – The Analog Output Module supports both standard 4-20mA DC outputs and HART transmitter outputs.
- **Analog Output w/o HART (16pt)** – The Analog Output Module supports standard 4-20mA DC outputs.
- **Digital Input 24 VDC (32pt)** – Digital input sensing for 24V signals
- **Digital Input Sequence of Events (32pt)** – Accepts 24VDC discrete signals as discrete inputs. The inputs can be time tagged to support 1ms resolution Sequence of Events.
- **Digital Input Pulse Accumulation (32pt)** – Accepts 24VDC discrete signals as discrete inputs. The first 16 channels can be configured as Pulse accumulation to support Pulse Accumulation and frequency measurement on per channel basis. Channels 17 – 32 can be configured as DI.
- **Digital Output 24 VDC (32pt)** – Current sinking digital outputs. Outputs are electronically short-circuit protected.
- **DO Relay Extension Board (32pt)** – Digital output with NO or NC dry contacts. It can be used for low power or high power applications.
- **Low Level Analog Input – RTD & TC (16pt)** – Provides thermocouple (TC) and resistance temperature device (RTD) inputs.

## 4.3. Series 8 I/O Sizing

In virtually all configurations, the C300 controller and Series 8 I/O provides useful, maintainable process equipment connections in a smaller footprint than existing competitors and Honeywell equivalent products. Installing Series 8 I/O modules contributes to overall total installed cost savings.

IOTA sizes vary based on the application. In general, an analog module has 16 points and resides on a 6 inch (152mm) IOTA for non-redundant applications and a 12 inch (304mm) IOTA for redundant applications. A discrete module has 32 points and resides on a 9-inch (228mm) IOTA for non-redundant applications and a 12 inch (304mm) IOTA for redundant applications. Specific information on the size of a particular module is described in the Model Number Table.

### 4.3.1. Series 8 Field connections

Series 8 Field connections use a standard modular connector. The connector modularity allows for removal and insertion of the field wiring. This significantly reduces installation and maintenance procedures and can assist in field check out. Series 8 field connectors accept up to 12 AWG / 2.5 mm<sup>2</sup> stranded wire.



### 4.3.2. I/O Module Sizes

IOTA Sizing is nominal (6in = 152mm, 9in =228mm, 12in =304mm). I/O modules are associated with their respective IOTAs in the table below. The I/O Module is supported by one or more IOTAs. Below section also provides an overview of various available IO modules, IOTA, IOTA size and redundancy features.

I/O Module (Coated)	IOTA (Coated)	Description	Circuits	Size (in “)	Red.
8C-PAIH54		High-level AI HART, Differential	16		√
	8C-TAIDA1	AI IOTA		9	
	8C-TAIDB1	AI IOTA Redundant		12	√
8C-PAIHA1		High-level AI HART, Single-ended	16		√
8C-PAINA1		High-level AI w/o HART, Single-ended	16		√
8C-TAIXA1		AI IOTA	6		
8C-TAIXB1		AI IOTA Redundant	12	√	
8C-PAIMA1		Low-level AI – RTD & TC	16		
	8C-TAIMA1	Low-level AI IOTA		9	
8C-PAOHA1		Analog Output HART	16		√
8C-PAONA1		Analog Output w/o HART	16		√
8C-TAOXA1		AO IOTA	6		
8C-TAOXB1		AO IOTA Redundant	12	√	
8C-PDILA1		Digital Input 24V	32		√
8C-PDISA1		Digital Input Sequence of Events	32		√
8C-PDIPA1		Digital Input 24V Pulse Accumulation	32		√
8C-TDILA1		DI 24V IOTA	9		
8C-TDILB1		DI 24V IOTA Redundant	12	√	
8C-PDODA1		DO 24V Bussed Out	32		√
	8C-TDODA1	DO 24V Bussed IOTA		9	
	8C-TDODB1	DO 24V Bussed IOTA Redundant		12	√
	8C-SDOX01	DO Relay Extension <sup>1</sup>		15	√

Note 1- DO Relay Extension board is used along with DO IO module with IOTA (Redundant or non-redundant). Refer Section [4.4.11](#) for more details.

## 4.4. Specifications for Series 8 I/O

Specifications for Series 8 I/O modules are shown below.

### 4.4.1. Analog Input with HART - Differential

#### Function

Analog Input Module accepts high level current or voltage inputs from transmitters and sensing devices.

#### Notable Features

- Extensive self-diagnostics
- Optional redundancy
- Supports either Single Ended / Differential Inputs
- HART-capable, multivariable instruments and multiple modems for fast collection of control variables
- Fast loop scan

#### Detailed Specification- Analog Input with HART - (8C-PAIH54)

Parameter	Specification
Input / Output Module	8C-PAIH54 - Analog Input with HART (16), Coated
IOTA Modules	8C-TAIDA1      Non Redundant, Coated      9"
	8C-TAIDB1      Redundant, Coated      12"
Input Type	Voltage, Current (2-wire or self-powered transmitters), Single ended or Differential inputs
Input Channels <sup>1</sup>	16 Channels (All 16 Single Ended or Differential type)
A/D Converter Resolution	16 bits
Input Range <sup>1</sup>	0 to 5 V, 1 to 5 V, 0.4 to 2 V, 4-20 mA (through 250 $\Omega$ )
Voltage Rating	24 VDC
Module Current Rating	310 mA
Common Mode Rejection Ratio, dc to 60 Hz (500 $\Omega$ source imbalance)	70 dB
Common Mode Voltage, dc to 60 Hz	-6 to +5 V peak
Normal Mode Rejection Ratio, at 60 Hz	19 dB
Normal Mode Filter Response	Single-pole RC, -3 dB @ 6.5 Hz
Crosstalk, dc to 60 Hz (channel-to-channel)	-60 dB
Input Impedance (voltage inputs)	> 10 M $\Omega$ powered
Maximum Normal Mode Input (any input referenced to common, no damage)	$\pm$ 30 Volts

---

Input Scan Rate	50 ms
Hardware Accuracy (@ CMV = 0 V)	$\pm 0.075\%$ of full-scale ( $23.5^{\circ}\pm 2^{\circ}\text{C}$ ) $\pm 0.15\%$ of full-scale (0 to $60^{\circ}\text{C}$ )
Module Removal and Insertion Under Power	Supported
Transmitter Field Power Conditioning	Individually Protected Current Limiting Circuits, No fuse required
Note 1 – 8C-PAIH54 supports voltage inputs for channels 1-16 when used with 8C-TAIDx1 IOTA. Each channel's 250-Ohm load resistor is connected to the input terminal through a wire jumper on the IOTA. This jumper should be cut by the user on channels to be used with voltage transmitters.	

#### 4.4.2. Analog Input with HART – Single Ended

##### Function

The Analog Input Module accepts high level current inputs from transmitters and sensing devices.

##### Notable Features

- Extensive self-diagnostics
- Optional redundancy
- HART-capable, multivariable devices
- Fast loop scan
- Internal or external field power selection
- On board excitation power (no need for marshalling power)
- Suitable for Configure / Status for HART Device
- Galvanic Isolation

##### Detailed Specification- Analog Input with HART (8C-PAIHA1)

Parameter	Specification
Input / Output Module	8C-PAIHA1 - Analog Input with HART (16), Coated
IOTA Modules	8C-TAIXA1      Non Redundant, Coated      6"
	8C-TAIXB1      Redundant, Coated      12"
Input Type	Current (2-wire or self-powered transmitters)
Input Channels	16 Channels (Single Ended type)
A/D Converter Resolution	16 bits
Input Range <sup>1</sup>	4-20 mA (through 250 $\Omega$ )
Voltage Rating	24 VDC
Module Current Rating	110 mA
Common Mode Rejection Ratio, dc to 60 Hz (500 $\Omega$ source imbalance)	70 dB
Common Mode Voltage, dc to 60 Hz	-6 to +5 V peak
Normal Mode Rejection Ratio, at 60 Hz	19 dB
Normal Mode Filter Response	Single-pole RC, -3 dB @ 6.5 Hz
Maximum Normal Mode Input	$\pm 30$ Volts
Crosstalk, dc to 60 Hz (channel-to-channel)	-60 dB
Maximum Input voltage (any input referenced to common, no damage)	$\pm 30$ Volts
Input Scan Rate	50 ms
Hardware Accuracy (@ CMV = 0 V)	$\pm 0.075\%$ of full-scale (23.5 $\pm$ 2 $^{\circ}$ C) $\pm 0.15\%$ of full-scale (0 to 60 $^{\circ}$ C)

---

Galvanic Isolation (any input terminal voltage referenced to common) <sup>2</sup>	1000VAC RMS or ±1000 VDC
Isolation Technique	Icoupler (in IOM)
Module Removal and Insertion Under Power	Supported
Transmitter Field Power Conditioning	Individually Protected Current Limiting Circuits. No fuse required
Note 1 – No differential / voltage inputs are supported.	
Note 2 – System to Field type isolation, option available only with external user supplied power	

### 4.4.3. Analog Input – Single Ended

#### Function

The Analog Input Module accepts high level current inputs from transmitters and sensing devices.

#### Notable Features

- Extensive self-diagnostics
- Optional redundancy
- Fast loop scan
- Internal or external field power selection
- On board excitation power (no need for marshalling power)
- Galvanic Isolation (System to Field only with external user supplied power)

#### Detailed Specification- Analog Input (8C-PAINA1)

Parameter	Specification		
Input / Output Module	8C-PAINA1 - Analog Input without HART (16), Coated		
IOTA Modules	8C-TAIXA1	Non Redundant, Coated	6"
	8C-TAIXB1	Redundant, Coated	12"
Input Type	Current (2-wire or self-powered transmitters)		
Input Channels <sup>1</sup>	16 Channels (Single Ended type)		
A/D Converter Resolution	16 bits		
Input Range	4-20 mA (through 250 $\Omega$ )		
Voltage Rating	24 VDC		
Module Current Rating	105 mA		
Common Mode Rejection Ratio, dc to 60 Hz (500 $\Omega$ source imbalance)	70 dB		
Normal Mode Rejection Ratio, at 60 Hz	19 dB		
Normal Mode Filter Response	Single-pole RC, -3 dB @ 6.5 Hz		
Maximum Normal Mode Input	$\pm 30$ Volts		
Crosstalk, dc to 60 Hz (channel-to-channel)	-60 dB		
Maximum Input voltage (any input referenced to common, no damage)	$\pm 30$ Volts		
Input Scan Rate	50 ms		
Hardware Accuracy (@ CMV = 0 V)	$\pm 0.075\%$ of full-scale (23.5 $\pm$ 2 $^{\circ}$ C)		
	$\pm 0.15\%$ of full-scale (0 to 60 $^{\circ}$ C)		
Galvanic Isolation (any input terminal voltage referenced to common) <sup>2</sup>	1000VAC RMS or $\pm 1000$ VDC		

---

Isolation Technique	Icoupler (in IOM)
Module Removal and Insertion Under Power	Supported
Transmitter Field Power Conditioning	Individually Protected Current Limiting Circuits. No fuse required
Note 1 – No differential / voltage inputs are supported.	
Note 2 – System to Field type isolation, option available only with external user supplied power	

#### 4.4.4. Low Level Analog (Temperature) Input LLAI

##### Function

The Low Level Analog Input (LLAI) Module accepts up to 16 channels of temperature inputs from RTD & TC.

##### Notable Features

- TC and RTD operation
- Remote Cold Junction compensation capability
- 1 Second PV scanning with OTD protection
- Configurable OTD protection (See below)
- Temperature points can be added in 16 point increments

##### Temperature Support

The Temperature variable is collected from all points at a 1 second rate. The 1 second update includes a configurable check for Open Thermocouple Detection (OTD) (see below) before propagation of the temperature variable. All TC inputs include integral Cold Junction Compensation (CJC).

##### Sampling and Open Sensor Detect

The TC/RTD IOM supports a configuration parameter for Open Sensor Detect before PV delivery. With the OTD configuration active, the PV is sampled and held while an OTD cycle is performed within the same measurement window. If the OTD is negative, the PV is propagated up through the system. If the OTD is positive, the PV is set to NAN and the input channel soft failure is set. In this way, no inappropriate control action occurs for PV values that are invalid due to an open thermocouple. PV sampling/reporting incurs no added delays from OTD processing.

##### Detailed Specification- Low Level Analog Input – RTD & TC (8C-PAIMA1)

Parameter	Specification
Input / Output Module	8C-PAIMA1- Low Level Analog (Temperature) Input, Coated
IOTA Modules	8C-TAIMA1      Non-Redundant, Coated      9"
Input Type	Thermocouple and / or RTD
Voltage Rating	24 VDC
Module current rating	120m A
Input Channels	16 fully-isolated channel-to-channel, channel-to-IOL, and channel-to-power supply common in 16 channel increments
Input scan rate	1 second fixed by IOM, (up to 16 channels/sec max.)
Channel bandwidth	0 to 4.7 Hz (-3 dB)
Nominal input range (TC only)	-20 to +100 millivolts
Maximum normal mode continuous input non-damaging (any thermocouple type configured)	-10 to +10 volts (TC) -1 to +2 Volts @ 100 milliamps (RTD)
Gain error (-20 to +100 millivolt range)	0.050% full scale max



Temperature stability	TC, millivolt inputs	+/-20 ppm per deg C max	
	RTD inputs	+/-20 ppm per deg C max	
Long term drift		500 ppm	
Input impedance		1 megohm at dc (TC only)	
CMV with respect to Power System common, dc to 60 Hz		Channel to Shield :+/-250 VDC or VAC RMS Channel to Channel: +/-33 VDC or VAC RMS	
CMRR, 50 or 60 Hz (with 1000 ohms source impedance max.)		120 dB min	
Voltage, channel-to-channel, dc to 60 Hz		+/-33 VDC or VAC RMS	
Voltage, channel-to-shield, dc to 60 Hz		+/-250 VDC or VAC RMS	
Crosstalk, dc to 60 Hz		80 dB (120 dB at 50 and 60 Hz)	
NMRR at 50/ 60 Hz		60 dB min	
Line frequency integration		Fixed selection of 50 Hz or 60 Hz	
RTD sensor excitation current		1 milliamp	
Cold Junction Compensation Range		-20 to +60 deg C ( $\pm 0.5$ deg C typical)	
TC Linearization Accuracy <sup>1</sup>		$\pm 0.05 \Omega / \text{deg C}$	
Open Thermocouple Detection		Each conversion qualified, $\leq 1000 \Omega$ = guaranteed no-trip $\geq 1500 \Omega$ guaranteed trip.	
RTD Max Lead Resistance		15 $\Omega$	
Surge protection (sensor terminals)		EN 61000-4-5 (for Industrial locations, 1kV line to line, 2kV line to gnd.)	
Surge protection (power/serial link with cable adapter option)		EN 61000-4-5 (for Industrial locations, 1kV line to line, 2kV line to gnd.)	
Supported RTD types	Pt: 100 ohm DIN 4376	-180 to +800 deg C	
	Pt: 100 ohm JIS C-1604	-180 to +650 deg C	
	Pt: 1000 ohm	-40 to +260 deg C	
	Ni: 120 ohm ED #7	-45 to +315 deg C	
	Cu: 10 ohm SEER	20 to +250 deg C	
	Cu: 50 ohm SEER	-50 to +150 deg C	
Supported Thermocouple types	ANSI specification J	-200 to +1200 deg C	
	ANSI specification K	-100 to +1370 deg C	
	ANSI specification E	-200 to +1000 deg C	
	ANSI specification T	-230 to +400 deg C	

	ANSI specification B	+100 to +1820 deg C
	ANSI specification S	0 to +1700 deg C
	ANSI specification R	0 to +1700 deg C
	ANSI specification N	-13 to +1300 deg C
Supported millivolt types	-20 to +100 millivolts	
Note 1 – Linearization polynomials are 4th order and based on NIST Monograph 175, ITS90 and JIS C-1602-1995		

#### 4.4.5. Analog Output with HART

##### Function

The Analog Output (AO) Module delivers high-level constant current to actuators and recording/indicating devices.

##### Notable Features

- Extensive self-diagnostics
- Optional redundancy
- HART-capable, multivariable devices
- Safe-state (FAILOPT) behaviors configurable on a per channel basis

##### Safe-state Behavior (FAILOPT)

Series 8 AO module supports the FAILOPT parameter on a per channel basis. The user can configure each channel to either HOLD LAST VALUE, or SHED to a SAFE VALUE. The Output will always go to zero, the safe state, if the IOM device electronics fails.

##### Open-wire Detection

This Series 8 IO function can detect and annunciate open field wire with a Channel Soft Failure indication.

##### Detailed Specification- Analog Output with HART (8C-PAOHA1)

Parameter	Specification		
Input / Output Module	8C-PAOHA1 - Analog Output with HART, Coated		
IOTA Modules	8C-TAOXA1	Non-Redundant, Coated	6"
	8C-TAOXB1	Redundant, Coated	12"
Output Type	4-20 mA		
Output Channels	16		
Output Ripple	< 100 mV peak-to-peak at power line freq, across 250 $\Omega$ load		
Output Temperature Drift	0.005% of Full Scale/ $^{\circ}$ C		
Output Current Linearity	$\pm$ 0.05% of Full Scale nominal		
Load Resistance (24 V supply = 22 VDC through 28 VDC)	50-800 $\Omega$		
Voltage Rating	24 VDC		
Module current rating	205 mA		
Resolution	$\pm$ 0.05% of Full Scale		
Calibrated Accuracy	$\pm$ 0.2% of Full Scale (25 $^{\circ}$ C) including linearity		
Directly Settable Output Current Range	2.9 mA to 21.1 mA		
Maximum Output Compliant Voltage (24 V supply = 22 VDC through 28 VDC)	16 V		

---

Maximum Open Circuit Voltage	22 V
Response Time(DAC input code to output)	Settles to within 1% of final value within 80 ms
Gap (0 mA) of Output to Field on Switchover	10 ms maximum (applies to Redundancy only)
Module Removal and Insertion Under Power	Supported

#### 4.4.6. Analog Output

##### Function

The Analog Output (AO) Module delivers high-level constant current to actuators and recording/indicating devices.

##### Notable Features

- Extensive self-diagnostics
- Optional redundancy
- Safe-state (FAILOPT) behaviors configurable on a per channel basis

##### Safe-state Behavior (FAILOPT)

Series 8 AO module supports the FAILOPT parameter on a per channel basis. The user can configure each channel to either HOLD LAST VALUE, or SHED to a SAFE VALUE. The Output will always go to zero, the safe state, if the IOM device electronics fails.

##### Open-wire Detection

This Series 8 IO function can detect and annunciate open field wire with a Channel Soft Failure indication.

##### Detailed Specification- Analog Output (8C-PAONA1)

Parameter	Specification		
Input / Output Module	8C-PAONA1 - Analog Output, Coated		
IOTA Modules	8C-TAOXA1	Non-Redundant, Coated	6"
	8C-TAOXB1	Redundant, Coated	12"
Output Type	4-20 mA		
Output Channels	16		
Output Ripple	<100 mV peak-to-peak at power line frequency, across 250 $\Omega$ load		
Output Temperature Drift	0.005% of Full Scale/ $^{\circ}$ C		
Output Current Linearity	$\pm$ 0.05% of Full Scale nominal		
Load Resistance (24 V supply = 22 VDC through 28 VDC)	50-800 $\Omega$		
Voltage Rating	24 VDC		
Module current rating	190 mA		
Resolution	$\pm$ 0.05% of Full Scale		
Calibrated Accuracy	$\pm$ 0.2% of Full Scale (25 $^{\circ}$ C) including linearity		
Directly Settable Output Current Range	2.9 mA to 21.1 mA		
Maximum Output Compliant Voltage (24 V supply = 22 VDC through 28 VDC)	16 V		

---

Maximum Open Circuit Voltage	22 V
Response Time (DAC input code to output)	settles to within 1% of final value within 80 ms
Gap (0 mA) of Output to Field on Switchover	10 ms maximum (applies to Redundancy only)
Module Removal and Insertion Under Power	Supported

#### 4.4.7. Digital Input 24VDC

##### Function

The Digital Input 24VDC accepts 24VDC signals as discrete inputs.

##### Notable Features

- Extensive self-diagnostics for data integrity
- Optional redundancy
- Internal / External field power selection
- On board excitation power (no need for marshalling power)
- Direct / Reverse Input indication
- Galvanic isolation

##### Detailed Specification- Digital Input 24VDC (8C-PDILA1)

Parameter	Specification		
Input / Output Module	8C-PDILA1 - Digital Input 24VDC, Coated		
IOTA Modules	8C-TDILA1	Non Redundant, Coated	9"
	8C-TDILB1	Redundant, Coated	12"
Input Channels	32		
Galvanic Isolation (any input terminal voltage referenced to common) <sup>1</sup>	1000 VAC RMS or $\pm 1500$ VDC for System		
Isolation Technique	Optical (In IOM)		
Voltage Rating	24 VDC		
DI Power Voltage Range	18-30 VDC		
Module current rating	95 mA		
DI Power Voltage Range	18 to 30 VDC (For user supplied field power )		
ON Sense Voltage/Current	13 VDC (min) or 3 mA (min)		
OFF Sense Voltage/Current	5 VDC (max) or 1.2 mA (max)		
Input Impedance	4.2 K $\Omega$		
Absolute Delay Across Input Filter and Isolation	5 ms $\pm$ 20%		
Field Resistance for Guaranteed ON Condition	300 $\Omega$ max @ 15 VDC		
Field Resistance for Guaranteed OFF Condition	30 K $\Omega$ min @ 30 VDC		
Module Removal and Insertion Under Power	Supported		
Note 1 – System to Field type isolation, option available only with external user supplied power			

#### 4.4.8. Digital Input Sequence of Events

##### Function

The Digital Input Sequence of Events (DISOE) accepts 24VDC discrete signals as discrete inputs. The inputs can be time tagged to support 1ms resolution Sequence of Events

##### Notable Features

- Three modes of operation
  - Normal (20ms PV scan)
  - Sequence of Events (1ms resolution SOE, 20ms PV scan)
  - Low Latency (5ms PV scan)
- Extensive internal diagnostics for data integrity
- Optional redundancy
- Internal or external field power selection
- On board excitation power (no need for marshalling power)
- Direct / Reverse Input Indication
- Galvanic isolation

##### Detailed Specification – Digital Input SOE (8C-PDISA1)

Parameter	Specification		
Input / Output Module	8C-PDISA1 - Digital Input Sequence of Events, Coated		
IOTA Modules	8C-TDILA1	Non Redundant, Coated	9"
	8C-TDILB1	Redundant, Coated.	12"
Input Channels	32		
Input Channel Scanning (PV)	Normal = 20ms ; Fast = 5ms		
Digital Input Resolution for Sequence of Events (SOE)	1ms		
Voltage Rating	24 VDC		
DI Power Voltage Range	18 to 30 VDC		
Module current rating	95 mA		
Galvanic Isolation (any input terminal voltage referenced to common)	1000 VAC RMS or $\pm 1000$ VDC		
Isolation Technique	Optical (in IOM)		
ON Sense Voltage/Current	13 VDC (min) or 3 mA (min)		
OFF Sense Voltage/Current	5 VDC (max) or 1.2 mA (max)		
Input Impedance	4.2 K $\Omega$		
Absolute Delay Across Input Filter and Isolation	5 ms $\pm$ 20%		
Field Resistance for Guaranteed ON Condition	300 $\Omega$ max @ 15 VDC		
Field Resistance for Guaranteed OFF Condition	30 K $\Omega$ min @ 30 VDC		
Module Removal and Insertion under power	Supported		



#### 4.4.9. Digital Input Pulse Accumulation

##### Function

The Digital Input Pulse Accumulation accepts 24VDC signals as discrete inputs. The first 16 channels can be configured either as Digital Input or Pulse accumulation to support Pulse Accumulation and frequency measurement on per channel basis.

##### Notable Features

- Extensive internal diagnostics for data integrity
- Optional redundancy
- Internal / External field power selection
- Galvanic isolation
- Support Pulse Accumulation & frequency measurement
- Support mix of per channel Pulse accumulation and DI

##### Detailed Specification – Digital Input Pulse Accumulation (8C-PDIPA1)

Parameter	Specification		
Input / Output Module	8C-PDIPA1 - 24VDC Digital Input Pulse Accumulation, Coated		
IOTA Modules	8C-TDILA1	Non Redundant, Coated	9"
	8C-TDILB1	Redundant, Coated	12"
Input Channels <sup>1</sup>	32		
Galvanic Isolation (any input terminal voltage referenced to common) <sup>2</sup>	1000 VAC RMS		
Isolation Technique	Optical (In IOM)		
Voltage Rating	24 VDC		
DI Power Voltage Range	18 to 30 VDC (For user supplied field power )		
Module current rating	105 mA		
Signal Type (Pulse Accumulation)	Accumulation Type (0-1KHz, for minimum 30% DUTY CYCLE devices)		
Minimum Pulse Width	300 uSec		
Individual Channel SCAN Time	300 uSec		
ON Sense Voltage/Current	13 VDC (min) or 3 mA (min)		
OFF Sense Voltage/Current	5 VDC (max) or 1.2 mA (max)		
Input Impedance	4.2 K $\Omega$		
Absolute Delay Across Input Filter and Isolation	5 ms $\pm$ 20%		
Module Removal and Insertion Under Power	Supported		
Note 1 – Channels 1-16 can support Pulse accumulation on per channel basis and Channels 17-32 can be configured as DI			
Note 2 – System to Field type isolation, option available only with external user supplied power			

#### 4.4.10. Digital Output 24VDC

##### Function

The Digital Output bussed 24VDC (DO24V) module can switch reliable 24V digital output signals to control other process equipment as well as solenoid valves and interposing relays.

##### Notable Features

- Extensive internal diagnostics to ensure data integrity
- Optional redundancy
- Safe-state (FAILOPT) behaviors
- Direct/Reverse output support
- Latched, pulsed or pulse-width modulated output (per channel)
- Galvanic Isolation

##### Bussed 24VDC DO

The Digital Output Bussed 24VDC has provisions for both internal and external field power excitation. As a bussed output device, all of the outputs share a common return (ground). All outputs get their power from the same source, which can be either the system power supply or an externally connected 24V power supply. When selection is from an external source, outputs can be galvanically isolated from the Series 8 power system.

##### Safe-state Behavior (FAILOPT)

Series 8 DO module will support FAILOPT parameter on a per channel basis. The output can be directed by configuration to either HOLD THE LAST VALUE, or SHED to a SAFE VALUE. The safe value can be configured by the user.

##### Detailed Specification – Digital Output 24VDC (8C-PDODA1)

Parameter	Specification		
Input / Output Module	8C-PDODA1 - Digital Output 24 VDC, Field Isolated, Bussed output, Coated		
IOTA Modules	8C-TDODA1	Non Redundant, Coated	9"
	8C-TDODB1	Redundant, Coated	12"
Relay Extension Board	Supported, details in section <a href="#">4.4.11</a>		
Output Channels	32		
Output Type	Source		
Voltage Rating	24 VDC		
Module current rating	105mA		
Load Voltage	30 VDC Maximum		
Load Current <sup>1</sup>	100mA per channel (Max) and 3.2A per module (Max)		
Galvanic Isolation <sup>2</sup>	1000 VAC RMS or $\pm$ 1500 VDC		

On-State Voltage	24 VDC (typ) (load current @ 0.1A max)
Off-State Leak Current	5 $\mu$ A (max)
Turn-On/Turn-Off Time	10 ms (max)
Gap (0 current) of Output to Field on Switchover	None (0ms) (applies to Redundancy only)
Module Removal and Insertion Under Power	Supported
<p>Note 1 – Short circuit protection for DO channel would be using series FUSES in the output channel. Total four (4) fuses for 32 channels on DO IOTA</p> <p>Note 2 – System to Field type isolation, option available only with external user supplied power. A wiring option on the IOTA determines if outputs are referenced to the Series 8 system power or an external field power source</p>	

#### 4.4.11. DO Relay Extension Board

##### Function

The Digital Output Relay provides a dry contact for isolated low voltage / low current or high voltage / high current discrete output applications. Each relay supports a Form-C output contact. The Relay extension board connects the Digital Output 24V (DO24V) IOM with DO IOTA to support the Relay output.

##### Notable Features

- Galvanic isolation
- Isolated Dry Contact
- Counter EMF Snubbing Circuit
- LED indication for each channel ON condition

##### Detailed Specification – DO Relay Extension Board (8C-SDOX01)

Parameter	Specification		
Relay Extension Board	8C-SDOX01	Relay Extension, Coated	15"
Output Channels	32 isolated Form C (SPDT) contacts. Three screws per channel (NC, NO, COM) for Normal Open or Normal Close usage.		
Contact Type	Au over AgSnO <sub>2</sub>		
Maximum Load Voltage	250 VAC (RMS)/125 VDC		
Maximum Steady State Load Current per Output	Current	Voltage	
	5A	125 / 250 VAC (resistive)	
	3 A	30 VDC (resistive)	
	1 A	48 VDC (resistive)	
	0.2 A	125 VDC (resistive)	
	2 A	125 / 250 VAC (inductive = 0.4 power factor)	
	1 A	30 VAC (inductive L/R = 100 ms)	
	0.3 A	48 VAC (inductive L/R = 100 ms)	
	0.1 A	125 VAC (inductive L/R = 100 ms)	
Minimum Load Voltage	5 VDC <sup>1</sup>		
Minimum Load Current	10 mA or 100mA <sup>1</sup>		
Inrush Current (Max)	10A for 4s at a 10% duty cycle		
Voltage Rating	24 VDC		
Module current rating	1010 mA		
Isolation (Channel-to-channel, and channel-to-logic common)	1500 VAC RMS or ±1500 VDC		
Turn On Time	20 ms maximum		
Turn Off Time	20 ms maximum		

---

Contact Life	Mechanical : Min. 20,000,000 operations Electrical: Min. 100,000 operations @ 3A
Module Removal and Insertion Under Power	Supported
Relay Cable assembly <sup>2</sup>	Honeywell Part # 51155506-xxx (0.5 mtr to 50 mtr cable length options)
Note 1 – The minimum 10mA load current and 5 VDC load voltage specified are only valid if the contact has not been previously used in high current / high voltage applications. Once a relay contact is used in a high current / high voltage application, the minimum load current is 100mA	
Note 2 – Is used to connect Relay Extension board with DO IOM with IOTA	

## 4.5. Series 8 IO Function Matrix

The following tables assist in selecting I/O Modules and IOTAs with similar functional characteristics:

### AI Function Matrix

IOM	NR IOTA	Red IOTA	Function	
			AI 4-20 mA	HART
8C-PAIHA1	8C-TAIXA1	8C-TAIXB1	◆	◆
8C-PAINA1	8C-TAIXA1	8C-TAIXB1	◆	
8C-PAIH54	8C-TAIDA1	8C-TAIDB1	◆	◆

### TC/RTD Function Matrix

IOM	NR IOTA	Red IOTA	Function	
			TC	RTD
8C-PAIMA1	8C-TAIMA1	NA	◆	◆

### AO Function Matrix

IOM	NR IOTA	Red IOTA	Function	
			AIO 4-20 mA	HART
8C-PAOHA1	8C-TAOXA1	8C-TAOXB1	◆	◆
8C-PAONA1	8C-TAOXA1	8C-TAOXB1	◆	

### DI Function Matrix

IOM	NR IOTA	Red IOTA	Function		
			DI	SOE	PA
8C-PDILA1	8C-TDILA1	8C-TDILB1	◆		
8C-PDISA1	8C-TDILA1	8C-TDILB1		◆	
8C-PDIPA1	8C-TDILA1	8C-TDILB1			◆

### DO Function Matrix

IOM	NR IOTA	Red IOTA	Relay Extension	Source
8C-PDODA1	8C-TDODA1	8C-TDODB1	8C-SDOX01	◆

## 5. Series-8 Power Systems and Accessories

The Series 8 Mark II Power System provides 24 VDC power to compatible Series-8 components. Series-8 power is provided by Commercial Off the Shelf (COTS) power systems. The power system provides unique capabilities that are tailored for the particular Series-8 need.

### 5.1. COTS Series-8 Power System

Commercial Off the Shelf (COTS) power system for Series-8 is available when Battery Backup is not required. The COTS Power system provides redundant 24VDC primary power at 20 amps for Series 8 devices. The power system also provides capabilities to support integral field power. This eliminates the need for additional power sources as well as the additional wiring, fusing, marshalling and documentation costs. Various COTS power systems are available. Selection is a user preference.

#### 5.1.1. Notable Features

- Various COTS Power Systems available based on User Preference
- Space efficient design
- Validated for Series 8 hardware
- Optionally redundant power supply
- Seamless switch operation between power supplies
- Visual and point contact alarms on all power system components

#### 5.1.2. Model Numbers



**8U-PWSP05: TRIO**  
**PHX Contact**



**8U-PWSP04: PULS**



**8U-PWS02-CN:**  
**PULS**

Description	Model or Part Number
Power Supply Module, 24VDC/20A, PULSE, Conformal Coated, AC or DC Input	8U-PWSP02-CN
Power Supply Module, 24VDC/20A, PULS, AC Input only	8U-PWSP04
Power Supply Module, 24VDC/20A, TRIO-PS, Phoenix Contact	8U-PWSP05
Power Supply Module, 24VDC/20A, PULSE, Back Panel Assembly	51202960-100 <sup>1</sup>
Note 1 - 51202960-100 Back Panel Assembly is compatible with all power supply modules mentioned above.	

### 5.1.3. Detailed Specifications- Power System

Below section covers general power supply specifications that applies to the COTS power supply mentioned above. Any unique specification for the respective power supply is mentioned separately wherever required.

Power System Parameter	Operating Band <sup>1</sup>	Operating Limits <sup>2</sup>
AC Input (VAC, rms)	100-240VAC	85-264VAC [8U-PWSP04, 8U-PWSP05] 85-276VAC [8U-PWSP02-CN]
Current Consumption	4.6A@120VAC 2.48A@230VAC	-
Frequency (Hz)	50-60Hz	47-65Hz
Holdup (ms)	<b>@ 120VAC</b> 32ms [8U-PWSP02-CN] 26ms [8U-PWSP04] >13ms [8U-PWSP05] <b>@230VAC</b> 51ms [8U-PWSP02-CN] 26ms [8U-PWSP04] >13ms [8U-PWSP05]	<b>@ 120VAC</b> 32ms [8U-PWSP02-CN] 26ms [8U-PWSP04] >13ms [8U-PWSP05] <b>@230VAC</b> 51ms [8U-PWSP02-CN] 26ms [8U-PWSP04] >13ms [8U-PWSP05]
Output Voltage (VDC)	24-28VDC [8U-PWSP02-CN, 8U-PWSP04] 22.5-29.5VDC [8U-PWSP05]	24-28VDC [8U-PWSP02-CN, 8U-PWSP04] 22.5-29.5VDC [8U-PWSP05]
Output Current DC Output	0-20A	0-26A for 4 sec [8U-PWSP02-CN, 8U-PWSP04] 0-20A [8U-PWSP05]
Input Current @ 120/240 VAC line Inrush/ Rerush	13A <sub>peak</sub> [8U-PWSP02-CN, 8U- PWSP04] 15A <sub>peak</sub> [8U-PWSP05]	13A <sub>peak</sub> [8U-PWSP02-CN, 8U- PWSP04] 15A <sub>peak</sub> [8U-PWSP05]



<b>Power System Parameter</b>	<b>Operating Band<sup>1</sup></b>	<b>Operating Limits<sup>2</sup></b>
Efficiency	<b>@ 120VAC</b> 92.4% [8U-PWSP02-CN] 92.7% [8U-PWSP04] 91.0% [8U-PWSP05] <b>@ 230VAC</b> 93.9% [8U-PWSP02-CN] 94.0% [8U-PWSP04] 91.0% [8U-PWSP05]	<b>@ 120VAC</b> 92.4% [8U-PWSP02-CN] 92.7% [8U-PWSP04] 91.0% [8U-PWSP05] <b>@ 230VAC</b> 93.9% [8U-PWSP02-CN] 94.0% [8U-PWSP04] 91.0% [8U-PWSP05]
Power Factor	<b>@120VAC</b> 0.95 [8U-PWSP02-CN, 8U-PWSP04] 0.99 [8U-PWSP05] <b>@230VAC</b> 0.90 [8U-PWSP02-CN, 8U-PWSP04] 0.99 [8U-PWSP05]	<b>@120VAC</b> 0.95 [8U-PWSP02-CN, 8U-PWSP04] 0.99 [8U-PWSP05] <b>@230VAC</b> 0.90 [8U-PWSP02-CN, 8U-PWSP04] 0.99 [8U-PWSP05]
Ambient Temperature Range (Deg. C)	0 to 70	0 to 70
Maximum Rate of Change (deg.C/min)	0.25	1
<b>Note:</b> <ol style="list-style-type: none"> <li>Operating Band defines the range of operating conditions within which the system is designed to operate and for which operating influences are stated. Performance characteristics shown here are maintained when operating in this state. Please see ANSA/ISA D 51.1 for more information.</li> <li>Operating Limits define the range of conditions to which the system may be subjected without permanent damage to the equipment. In general, performance characteristics are not guaranteed in this state. Stated Operating Band characteristics are restored when returning to the Operating Band specifications without damage to the equipment. Please see ANSA/ISA D 51.1 for more information.</li> </ol>		

## 5.2. Header Board

The header board is used to distribute power and IOLink throughout the cabinet. It distributes 24 VDC from a power system to one or more columns of mounting plates in one or both sides of a cabinet that contains the power system. The IOTA receives its power and IOLINK communication through the combination power / IOLink Cable from the header board. One pair of header boards can provide redundant power and IO communication.



### 5.2.1. Notable Features

- Redundant power distribution and IOLink communication system
- Ability to extend power and IOLink to adjacent cabinets through connectors
- Four connectors for combination power / IOLink cable to IO modules in cabinet
- Combination power / IOLink cable is daisy-chained to allow connection to multiple IO modules, disconnecting cable from one IO module does not affect other modules

### 5.2.2. Model Number

Description	Model or Part Number
Series 8 Header Board	8C-SHEDA1

### 5.2.3. Detailed Specifications- Header Board

Header Board Parameter	Specifications
Power Input (VDC)	24
Power Output (VDC)	24
Power Connector	3
Combo Cable Connector	4 pairs, 6 pins
IOLINK Extension	2 pairs, 3 pins
Ambient Temperature Range (deg. C)	0 to 60

### 5.3. Circuit Breaker Box Assembly

A circuit breaker box provides the input control for the power system in the cabinet. It provides optional power input control for cabinet accessories. The default circuit breaker for a purpose-built power system is the standard AC terminal 3 input. For COTS, the default is a circuit breaker.

#### 5.3.1. Notable Features

- Two ways of Power Input, two ways of Power Output, two ways of Power Extension
- Two switches for controlling AC inputs on or off

#### 5.3.2. Model Number

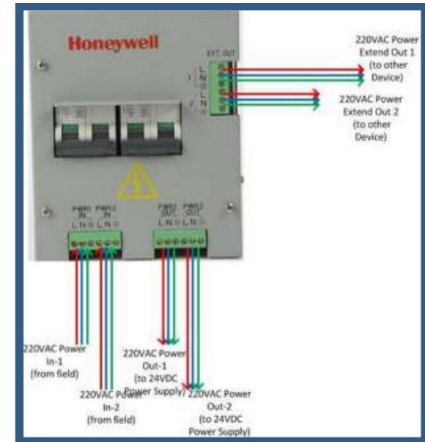

Description	Model or Part Number
Circuit Breaker Box Assembly	51307039-100

#### 5.3.3. Detailed Specification - Circuit Breaker Box Assembly

Circuit Breaker Box Parameter	Specifications
Power Input (VAC)	100-120/220-240
Power Output (VAC)	100-120/220-240
Capacity (A)	10
Power Input	2
Power Output	2
Power Extension	2
Ambient Temperature Range (deg. C)	0 to 60

## 5.4. C300 Controller memory backup

A RAM charger assembly provides memory backup power for S8 C300 controller module. RAM charger is used to back up the program memory of the S8 C300 controller. It supports connecting up to 4 physical S8 C300 controllers. Multiple units can be considered based on system cabinet design and number of controllers required.

### 5.4.1. Notable Features

- Support up to 4 C300 controllers in one module
- Supports redundant power supply inputs through combo cable
- Supports Experion soft failure alarm for RAM charger battery status
- Typically mounted adjacent to its associated C300 IOTA(s)



### 5.4.2. Model Number

Description	Model or Part Number
RAM Charger Assembly	51199932-200
Cable, MBA to one C300 Controller, 30 inches (0.7 m) long	51202330-100
Cable, MBA to one C300 Controller, 84 inches (2 m) long	51202330-200

### 5.4.3. Detailed Specification – RAM Charger Assembly

RAM Charger Assembly Parameter	Specifications
Form Factor	3 inch IOTA
Combo Cable Connector	1 pair, 6 pins
Standby Power Output	4
Memory Backup Hold-up Times	110 Hours (4.58 Days) for 1 C300 55 Hours (2.23 Days) for 2 C300s 36.6 Hours (1.52 Days) for 3 C300s 27.5 Hours (1.14 Days) for 4 C300s

## 5.5. S8 IO Extension Solutions

Series 8 I/O are connected to the S8 C300 by a pair of Combo cable interfaces. Two Combo cable interfaces, which are redundant, provide IO Link connection between the S8 C300 controller and associated S8 I/O modules. The Combo cable interface connectors are on the IOTA. Each Combo cable can be configured to support Series 8 I/O. The Fiber Option Extender modules support the extension of the I/O link beyond the Series 8 cabinet with the S8 C300, enabling remote applications of the Series 8 I/O.

### 5.5.1. Model Number

Description	Model or Part Number
<b>Multi-Mode</b>	
Multi-Mode, FO converter IO Module	8937-HN2
Multi-Mode Fiber Optic Extender IOTA	8939-HN

## 7. Glossary

Term or Acronym	Description
DSA	Distributed System Architecture
Experion HS Server	The node at the heart of Experion HS. The servers encompasses a wide range of subsystems including history collection, SCADA interfaces, alarm/event, etc.
FSC	Fail Safe Controller
HC900	Honeywell process automation controller
I/O	Input / Output
LAN	Local area network based on Ethernet technology
MD	Mode
ODBC	Open DataBase Connectivity
PV	Process Variable
SCADA	Supervisory control and data acquisition
SM	Honeywell Safety Manager
SP	Setpoint
SQL	Structured Query Language
UTC	Universal Coordinated Time
USB	Universal Serial Bus
HMI	Human machine interface
HMIWeb	Human machine interface based on Web Technology
HTML	Hypertext Markup Language
OPC	Series of standard specification for open connectivity in industrial automation originally based on Microsoft's OLE COM and DCOM technologies.
PPS	Parameters per second
RTU	Remote Terminal Unit

Experion® is a registered trademark of Honeywell International Inc.

All other products and brand names shown are trademarks of their respective owners.

This document contains Honeywell proprietary information. It is published for the sole usage of Honeywell Process Solutions' customers and prospective customers worldwide. Information contained herein is to be used solely for the purpose submitted, and no part of this document or its contents shall be reproduced, published, or disclosed to a third party without the express permission of Honeywell International Inc.

While this information is presented in good faith and believed to be accurate, Honeywell disclaims the implied warranties of merchantability and fitness for a particular purpose and makes no express warranties except as may be stated in its written agreement with and for its customer.

In no event is Honeywell liable to anyone for any indirect, special or consequential damages. The information and specifications in this document are subject to change without notice.

### **For More Information**

To learn more, visit [process.honeywell.com](https://process.honeywell.com) or contact your Honeywell Account Manager, Distributor or System Integrator.

### **Honeywell Process Solutions**

1250 West Sam Houston Parkway South  
Houston, TX 77042

Honeywell House, Skimped Hill Lane Bracknell,  
Berkshire, England RG12 1EB UK

Building #1, 555 Huanke Road, Zhangjiang Hi-Tech  
Industrial Park, Pudong New Area,

Shanghai 201203

<https://process.honeywell.com>

The Honeywell logo is displayed in a bold, red, sans-serif font.