











Technical Handbook

- [Table of Contents](#)
- [Introduction](#)
- [Installation](#)
- [Startup](#)
- [Operation](#)
- [Maintenance](#)
- [Troubleshooting](#)
- [Installation Drawings](#)
- [Specifications](#)
- [Detectable Gases](#)
- [Replacement and Consumable Items](#)
- [Optional Relay Specifications](#)
- [Network Interface and Options](#)
- [4-20mA Analog Output Option](#)
- [Line Integrity Test Option](#)
- [Warranty Statement](#)

Vertex M Continuous Monitor Symbols

Symbol	Description
 	<p>Power on</p> <p>Power off</p>
	<p>Potential damage to the device or other property, maintenance procedures, and “refer to manual” instructions.</p>
 CAUTION	<p>Lifting instructions, low clearances, slipping/tripping hazards, minor corrosive dangers. Also used when defining personal protective equipment (gloves, dust masks, etc.)</p>
 WARNING	<p>Personal injury risk: machinery hazards around guarded equipment, moving parts, crush/pinch hazards, flying debris, and arc flash hazards.</p>
 DANGER	<p>The most dangerous or potentially lethal hazards: unguarded equipment, confined space entrances, and lockout labels.</p>
	<p>Caution: possibility of electric shock</p>
	<p>Caution: hot surface</p>
	<p>Protective conductor terminal (ground terminal)</p>

EMC Considerations

Your Honeywell Analytics monitor has been designed to comply with applicable Electromagnetic Compatibility (EMC) standards at the time of manufacture. The design includes filtering, shielding and bypassing techniques. At the time of certification, simulated customer Input/Output (I/O) schemes were tested.

All methods used in your equipment for emission suppression and reduction of susceptibility are interactive. Modifications to the instrument could result in increased emissions and higher vulnerability to other radiated fields.

Following the guidelines in this EMC Considerations section will ensure your instrument maintains the highest degree of EMC integrity. The guidelines listed apply only to I/O emissions and do not apply to A.C. and D.C. instrument power connections.

FCC Compliance Statement



CAUTION: Changes or modifications not expressly approved could void your authority to use this equipment

This device complies with Part 15 of the FCC Rules. Operation to the following two conditions: (1) This device may not cause harmful interference, and (2) this device must accept any interference received, including interference that may cause undesired operation

Industry Canada Statement

This device complies with Industry Canada licence-exempt RSS standard(s). Operation is subject to the following two conditions: (1) this device may not cause interference, and (2) this device must accept any interference, including interference that may cause undesired operation of the device.

Le présent appareil est conforme aux CNR d'Industrie Canada applicables aux appareils radio exempts de licence. L'exploitation est autorisée aux deux conditions suivantes : (1) l'appareil ne doit pas produire de brouillage, et (2) l'utilisateur de l'appareil doit accepter tout brouillage radioélectrique subi, même si le brouillage est susceptible d'en compromettre le fonctionnement.

Cabling

At a very minimum, all cables should include a braided shield. Ideal results have been obtained with twisted pair cabling which has a foil shield surrounding each pair plus foil and 90% braid shielding around the bundle. In addition, ensure local electrical code requirements are met.

The following cable parameters must be considered:

Braid	Must have a minimum 90% coverage
Foil	When used with braid, provides 100% coverage Do not use foil alone. It has a tendency to break.
Twisted Pair	Provides for cancelling of magnetic fields
Stranded Pair	Provides the greatest surface area
Shield Termination	Continuation of the shield to the cabinet earth ground is most important. For discrete wire terminations, pigtails to the cabinet (connector) ground should be extremely short (absolutely no greater than three inches). For multiconductor connector terminations, only 360° shielded shells should be used.

Note:

Honeywell Analytics product testing uses >90% braid with foil (around the bundle); twisted pair; stranded 24 AWG (minimum wiring for all qualification and certification testing.)

Connectors

All qualification and certification of Honeywell Analytics products were achieved with high quality connectors, providing 360° shield coverage. These connectors generally had metal shells.

Failure to properly secure the connector to the equipment will result in high emission levels. Also, poorly constructed or improperly assembled connectors can be a high source of radiated noise and provide a path for external signals into the monitor.

Table of Contents

Symbols Used on Your Instrument.....	i	Installation.....	2-1
EMC Considerations.....	i	Introduction.....	2-2
Cabling.....	ii	Surveying the Installation Site.....	2-2
Connectors.....	ii	Placement of the Vertex M System.....	2-2
Introduction.....	1-1	Exposure to Dust and Humidity.....	2-2
System Overview.....	1-2	Sample Transport Time.....	2-2
Manufacturer.....	1-2	Instrument Dimensions.....	2-2
General Safety.....	1-2	Sample Locations.....	2-2
System Components.....	1-2	Sample Line Particulate Filter Use.....	2-3
Vertex M Front.....	1-3	Optional Floor Mounting.....	2-3
Vertex M Back.....	1-4	Installing Sample Lines/Filters.....	2-3
Sample Tubing, Exhaust and Wiring Ports.....	1-5	Sample Line Installation Requirements.....	2-3
Analyzer Side Panel.....	1-6	Sample Line Connections.....	2-4
Analyzer Front.....	1-7	Installing Sample Line Particulate Filters.....	2-4
System Controls.....	1-7	Installing Pump Exhaust Line.....	2-4
Data Acquisition Computer (rear).....	1-8	Exhaust Line Installation Requirements.....	2-5
Back of Chemcassette® Module.....	1-9	Exhaust Line Connection.....	2-5
Main PLC.....	1-10	Electrical Power.....	2-5
4-20mA Analog Output Option PLC.....	1-11	Connecting AC Power.....	2-5
Menu Map.....	1-12	Power On/Off.....	2-6
Analyzer Modules.....	1-13	Data Acquisition System.....	2-6
Sampling System.....	1-13	Printer.....	2-7
Chemcassette® Detection System.....	1-14	External Network Connection.....	2-7
Detector Optics.....	1-14	Network Computer Security.....	2-8
Stain Pattern.....	1-14	Wiring Alarm Relays.....	2-8
Chemcassette® Tapes.....	1-15	Relay Contacts.....	2-8
Optional ChemCam.....	1-15	Wiring Guidelines.....	2-9
Sample Filters.....	1-15	Startup.....	3-1
Pyrolyzer Module Detection System.....	1-16	Startup.....	3-2
Pyrolyzer Fan.....	1-16	Initial Startup.....	3-2
Vacuum Pumps.....	1-16	Factory Configuration.....	3-2
Multiple Gas Monitoring.....	1-16	Getting Started.....	3-2
Control System.....	1-17	Verify Installation.....	3-2
Data Acquisition Computer.....	1-17	Power Up.....	3-2
Programmable Logic Controller.....	1-17	Start Program.....	3-4

Configuration Utility	3-6	Run Time Options	4-26
 Define Gas Location	3-17	Flow Calibration	4-32
 Configure Analyzers and Points	3-19	Maintenance	4-40
 Set Analyzer Window	3-20	Diagnostics	4-41
 Configure Point	3-21	Service	4-44
 Define and Assign Relays	3-28	Security Access	4-47
 Configure PLC	3-29	Configuration	4-48
 Set Alarm Relays	3-30	OnScreen Keyboard	4-48
 Set Fault Relays	3-32	 Restore OnScreen Keyboard	4-48
 Profile Management-File Menu	3-34		
 Other Menu	3-34	Maintenance	5-1
Load Tape	3-34	Introduction	5-2
Verify Flow Rates and Supply Vacuum	3-35	Maintenance Schedules	5-2
 Verify Flow Rates	3-35	Chemcassette® Analyzer Maintenance	5-3
Leak Checking Sample Lines	3-39	 Remove and Replace Analyzer Particulate Filters	5-3
Reconfigure	3-39	 Remove Filters	5-4
Moving to a New Site	3-40	 Replace Filters	5-4
System Shut Down	3-41	 Change Chemcassette® Tape	5-5
		Replacing an Analyzer	5-6
Operation	4-1	 Disconnecting Cables	5-6
 Introduction	4-2	 Remove Analyzer	5-7
 Monitoring Mode Overview	4-2	 Install Analyzers	5-7
 Main Screen	4-3	Remove and Replace Pyrolyzer Filters	5-7
 System Display Area	4-4	 Remove Filters	5-8
 Point Detail Display Area	4-8	 Replace Filters	5-8
 Function Buttons	4-10	Remove and Install Pumps	5-9
Project Functions	4-10	 Remove Pump	5-11
 Log In and Log Out	4-11	 Install New Pump	5-11
 Changing Password	4-11	Remove and Install Power Supplies	5-12
 Updating Program	4-12	 Remove Supply	5-12
 Restore OnScreen Keyboard	4-12	 Replace Supply	5-12
 Stopping Project	4-12	Clean the Touch Screen	5-12
Review Functions	4-12	PLC Module Battery Backup Check	5-13
 Event History	4-13	File Maintenance	5-14
 Data Trend	4-20	Optics Cleaning	5-15
 Optional ChemCam	4-22		
 Event List	4-24		
Menu Buttons	4-26		

Troubleshooting	6-1	Pyrolyzers	D-3
Introduction	6-2	Rack Systems	D-3
General System Problems	6-2	Power Distribution Module	D-3
Maintenance Faults	6-5	Pump Modules	D-3
Instrument Faults	6-10	Optional Relay Specifications	E-1
Information Events	6-16	Relay Output Contacts	E-2
LIT-Related Informational Events	6-19	Relay Contact Ratings	E-2
Manual Analyzer Override	6-20	Default Relay Assignments	E-3
Installation Drawings	A-1	Introduction	E-3
Introduction	A-2	Main PLC	E-3
Floor Space Requirements	A-3	Terminal Assignment of 1746-OW16 Relay Module	E-3
General Considerations and Cooling	A-4	Terminal Assignment of 1746-OX8 Relay Module	E-4
General Wiring	A-5	Network Interface and Options	F-1
4-Port Manifold Option	A-7	Network Interface and Options	F-2
Floor Mounting Option	A-8	OLE for Process Control (OPC) Interface	F-3
Specifications	B-1	Setting Up an OPC Client Application	F-3
Introduction	B-2	Data Values Common to Fieldbus Networks	F-9
Filter Compatibility	B-2	Alarms and Faults	F-9
Physical Dimensions	B-3	Concentrations	F-9
Nominal Transport Times	B-4	Heartbeat	F-10
Detectable Gases	C-1	Data Map	F-11
Detectable Gases	C-2	Profibus Option (P/N 1295-275)	F-12
Replacement and Consumable Items	D-1	Termination	F-12
Consumables	D-2	Profibus Module Configuration	F-12
Chemcassettes®	D-2	DeviceNet Interface (P/N 1295-0329)	F-14
End of Line Particulate Sample Filters	D-2	ControlNet Interface	F-14
Analyzer Filters	D-2	DF1 Interface (P/N1295-0343)	F-15
Pyrolyzer Filters	D-2	Modbus Plus Interface (P/N 1295-0330)	F-16
Rack Filters	D-2	LonWorks Interface (P/N 1295-0329)	F-16
Printed Circuit Boards	D-2	Modbus/TCP (P/N1295-0520)	F-17
Pyrolyzers	D-2	Configuring the IP Address	F-17
All Analyzers	D-2	Ethernet/CIP (P/N1295-0519)	F-20
Power Distribution Module	D-2	Configuring the IP Address	F-21
Components	D-2	Vertex M Remote Display Setup	F-21
All Analyzers	D-2	Checking Remote Session Count	F-21
		Determining the IP Address	F-22

Basic Desktop Station Setup	F-22
Installing Java Runtime Environment Software .	F-22
Install Adobe Reader Software	F-22
Create HMI account	F-22
Starting the Niagara Remote Display	F-22
Full Desktop Station Setup	F-25
Add Honeywell software to Desktop	F-25
Create a “Honeywell Analytics” account	F-25
Create Group “VertexDCOMUsers”	F-25
Disable Windows Firewall	F-27
Configure DCOM	F-27
Windows Firewall	F-32
Create matching Windows Accounts	F-33
Demonstrating Remote OPC Communication	F-34
Setup Procedure.....	F-34
Demonstration with Matrikon OPC Explorer.....	F-35
Demonstration with DAClient.....	F-38
4-20mA Analog Output Option	G-1
Overview.....	G-2
Hardware Requirements.....	G-2
Configuration Requirements.....	G-2
Operational Description	G-3
Line Integrity Test Option	H-1
Warranty Statement.....	I-1
Chemcassette® Device Warranty Statement.....	I-2
Chemcassette® Warranty.....	I-3

1 Introduction

1.1 System Overview

The Honeywell Analytics Vertex M™ System continuously monitors up to 24 remote locations for toxic gases. It responds to gases that exceed programmed levels by:

- Triggering alarms and opening event windows to warn operators of high or low concentrations
- Triggering relays to external devices
- Displaying the location, gas type and gas concentration
- Storing the alarm information in a database

The Vertex M System provides fast response to a wide range of gases. Each location may be up to 400 ft (122 m) from the Vertex M System. The system uses one or more of Honeywell Analytics' Chemcassette® analyzers, with or without pyrolyzer, to provide a monitoring system tailored to meet the requirements of the facility.

The Vertex M System incorporates a range of redundant and protective features for maximum uptime:

- Intelligent analyzer modules allow one to stop monitoring with no effect on the remaining modules
- Power supplies are redundant
- Pumps are redundant
- The system powers up in the same state as when powered down

- Filters, Chemcassettes® and major components in one of the analyzers can be replaced while the remaining analyzers continue to function

Operation can be through an LCD touch screen or through a local area network (LAN).

Chemcassette® is a registered trademark of Honeywell Analytics, Inc.

1.1.1 Manufacturer

The Vertex M System is manufactured by:

Honeywell Analytics Inc.
405 Barclay Boulevard
Lincolnshire, IL 60069 USA
www.honeywellanalytics.com

1.1.2 General Safety

Follow all installation and operational instructions to ensure the safe and reliable operation of this unit.

If this monitor is used in a manner not specified by Honeywell Analytics Inc., the protection provided by the equipment may be impaired.

1.2 System Components

The following photos illustrate Vertex M System components, ports, connections and controls. From the main front and back photos, click on the labels to see the detail photos.

1.2.1 Vertex M Front

[Sample Tubing, Exhaust and Wiring Ports](#)

Relay PLC (behind monitor)

See [Relay Options](#) or [Network Interface Options](#)

Touch Screen

[System Controls](#)

Universal Chemcassette®
Analyzer

[Analyzer Front](#)

Pyrolyzer Analyzer

[Analyzer Side Panel](#)

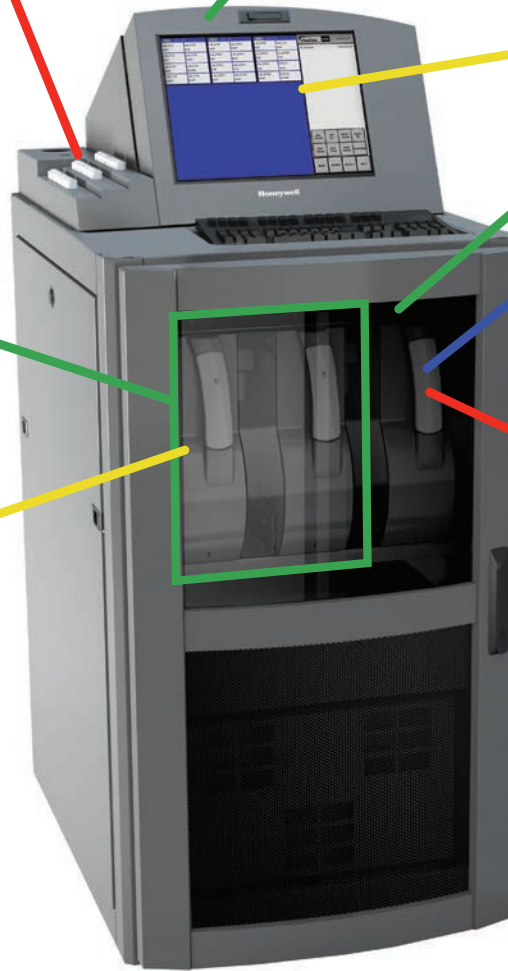

1.2.2 Vertex M Back

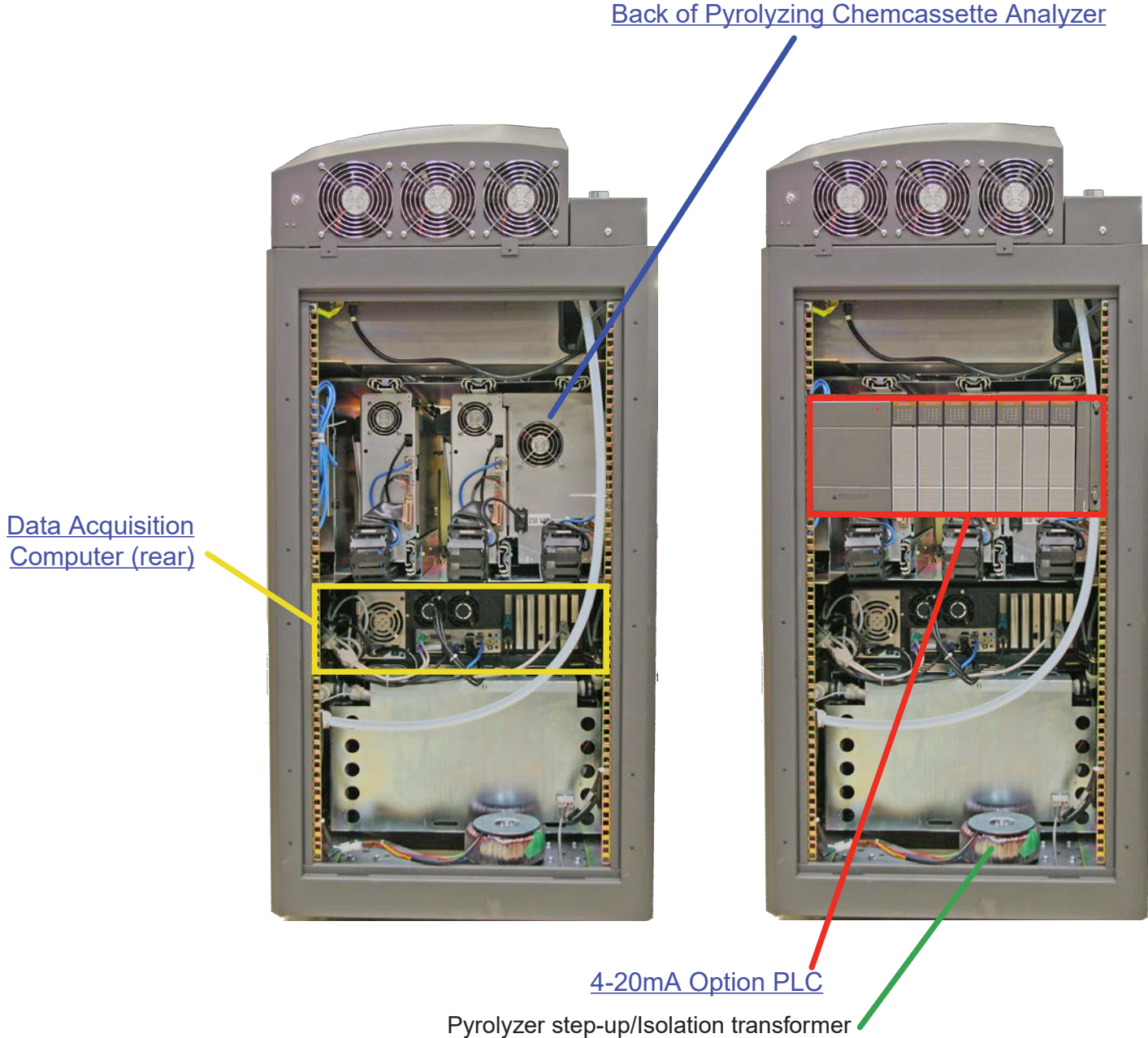

1.2.3 Sample Tubing, Exhaust and Wiring Ports

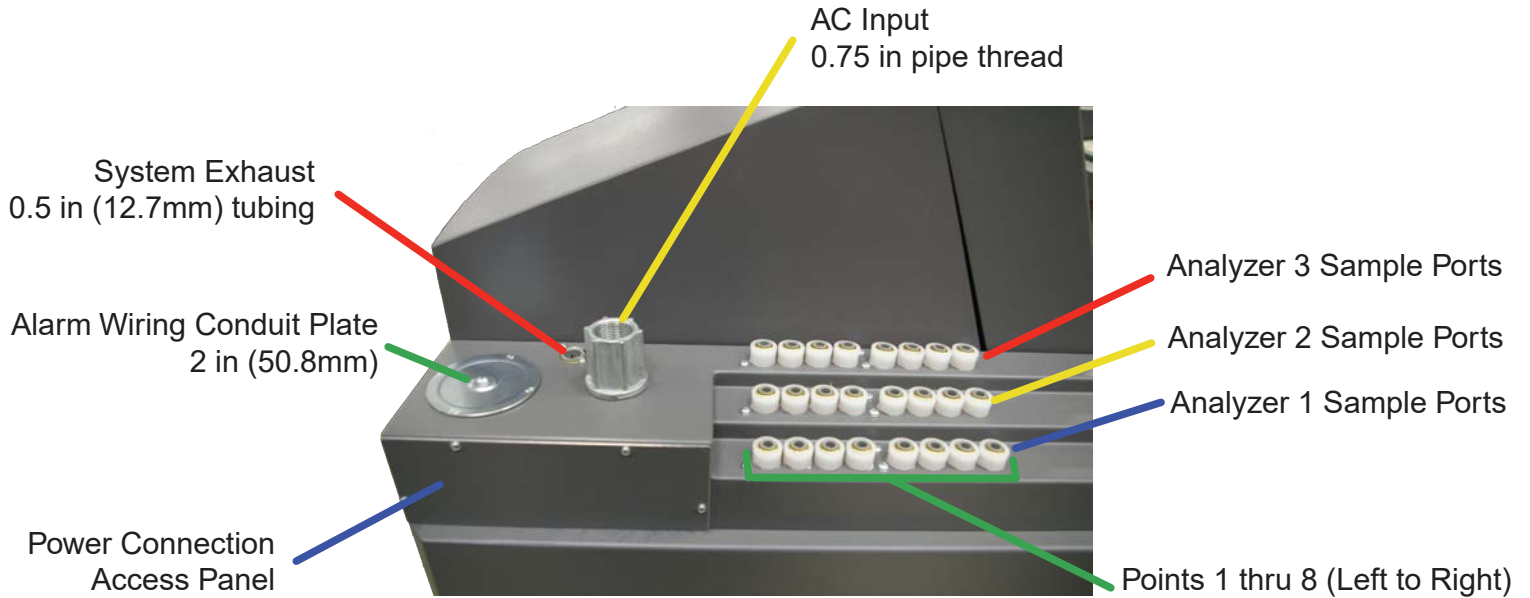

3-Port Manifold for multiple gas sampling
See [Section A.4 Nominal Transport Times](#) for tubing
length limitations

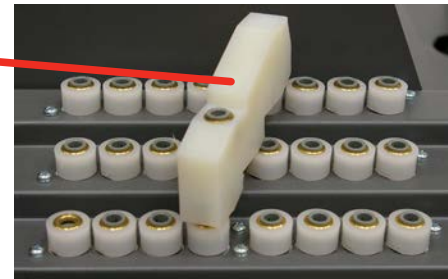

Note:

The Alarm wiring conduit plate must remain in place if not used.

1.2.4 Analyzer Side Panel Exterior View

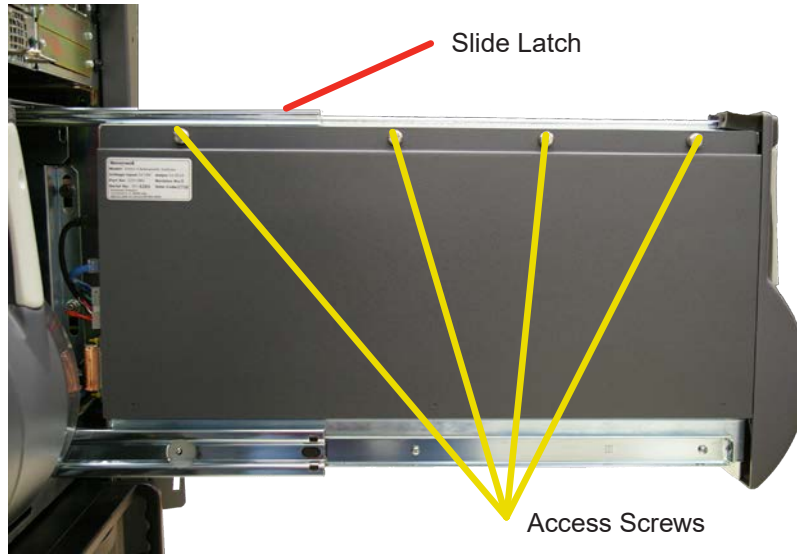

Internal View

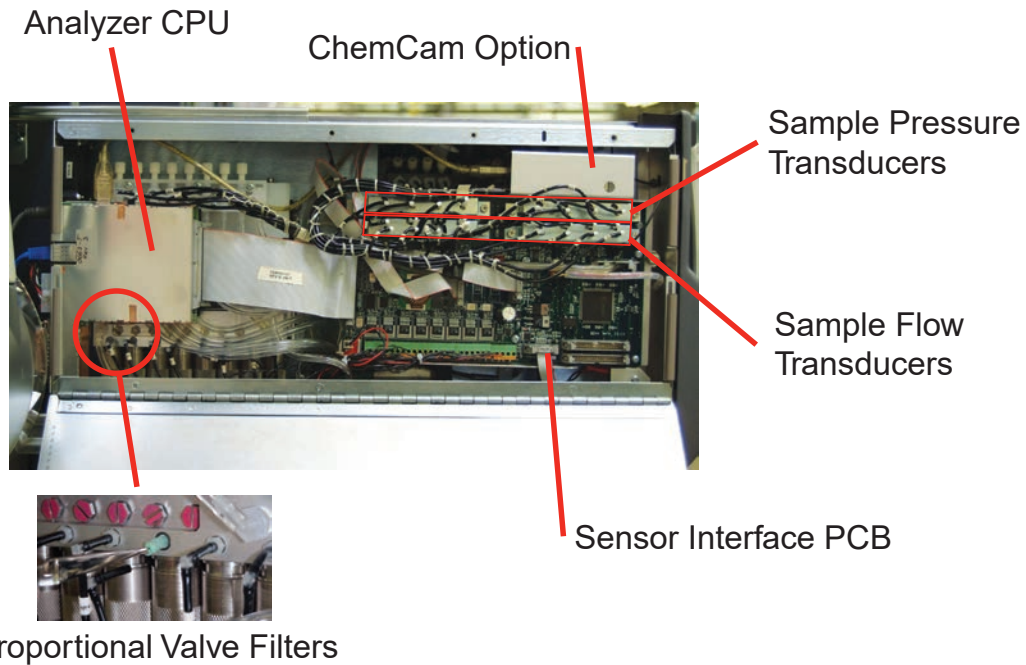

1.2.5 Analyzer Front



1.2.6 System Controls

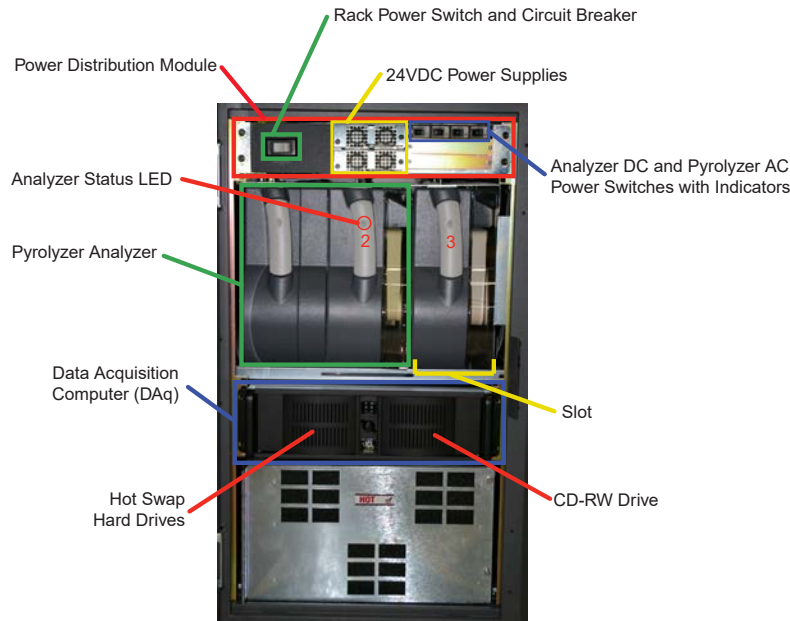

1.2.7 Data Acquisition Computer (rear)

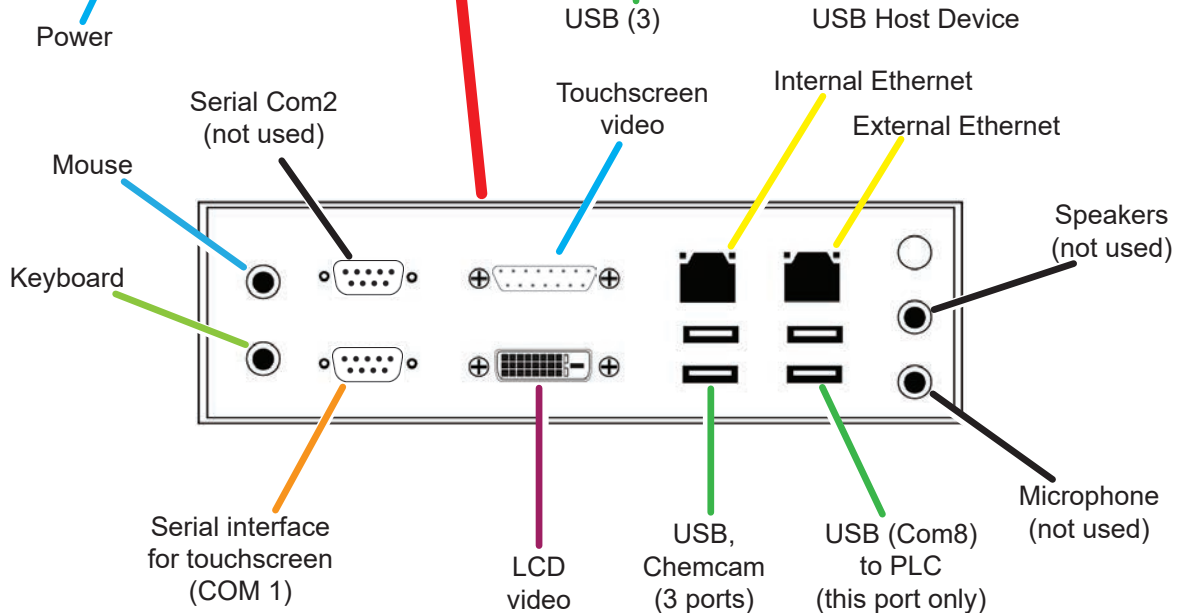
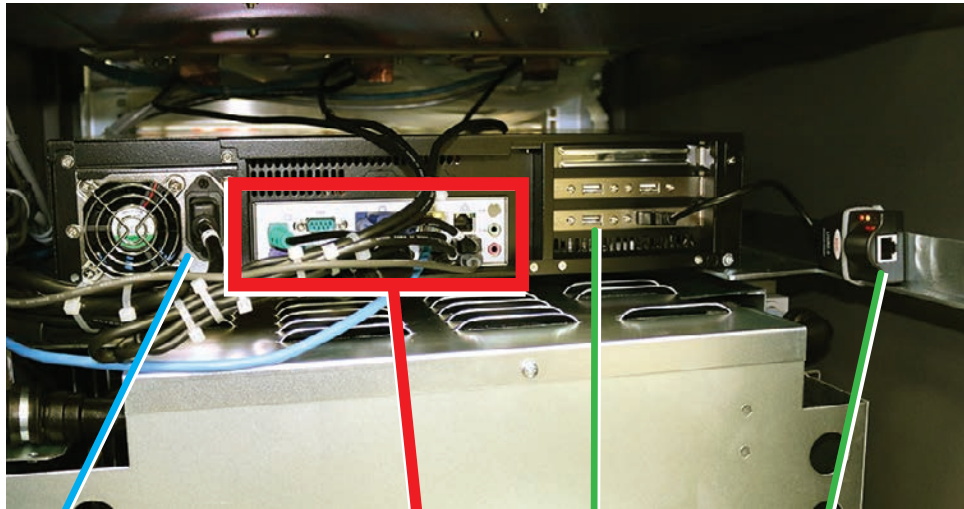

Caution:

Restrict access to the USB port to reduce the risk of malicious software being introduced.

Note:

This photograph shows a typical port configuration. Port and slot locations vary from model to model.

1.2.8 Back of Chemcassette® Module

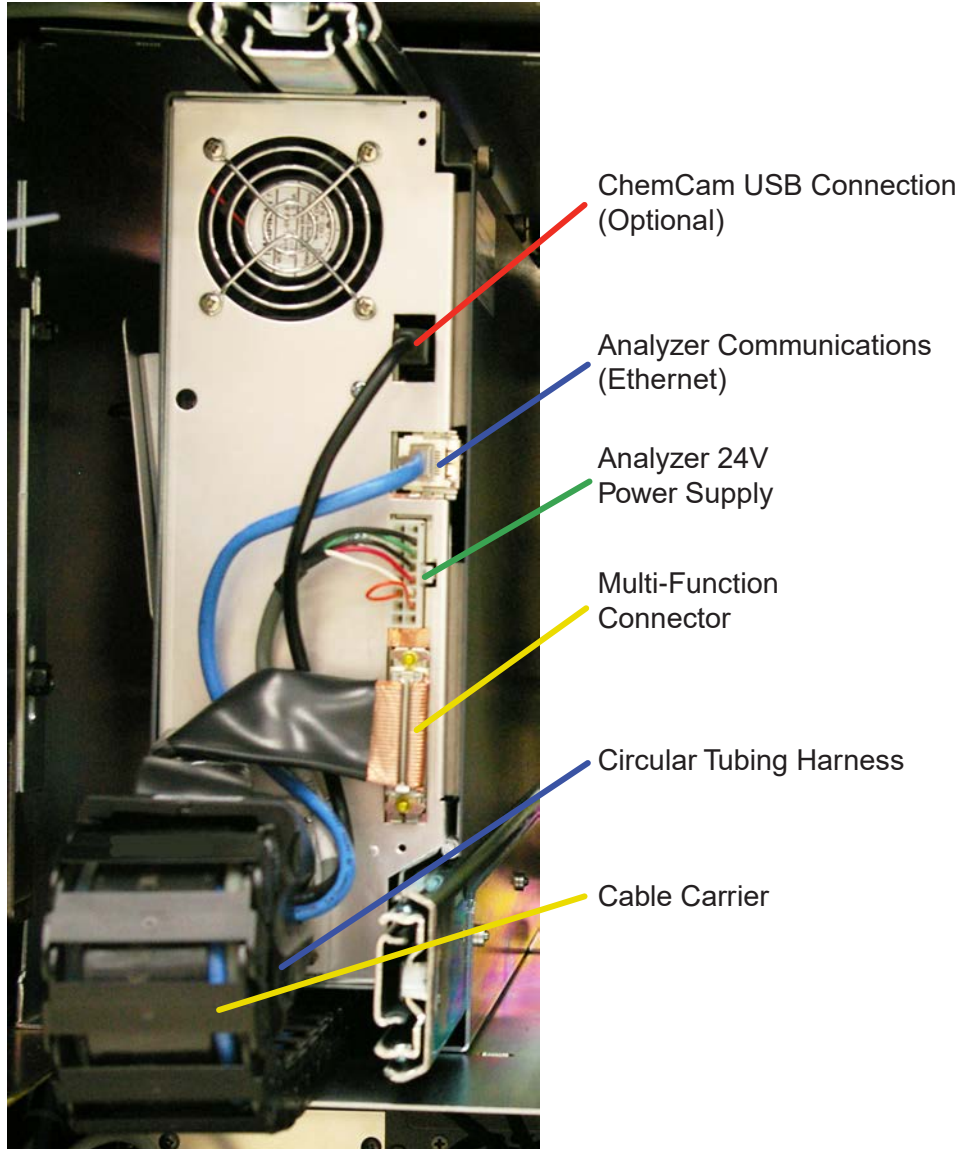

Note:

Connection secured by slide latch. Push up to open. Push down to close.

1.2.9 Main PLC

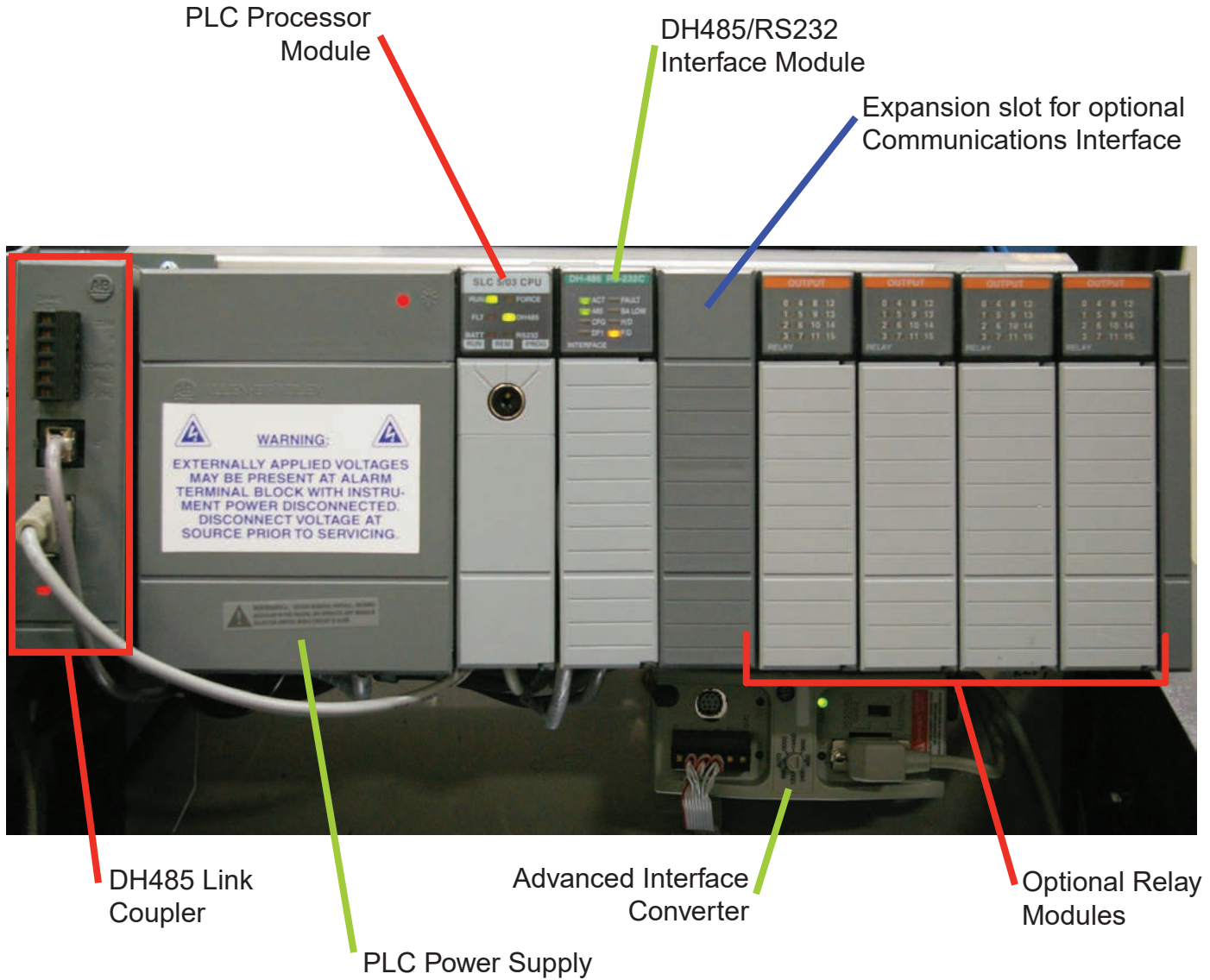

Vertex M™ 24-Point Continuous Monitor

1.2.10 4-20mA Analog Output Option PLC



Power Supply

4-20mA Output Modules (6X)

1.3 Menu Map

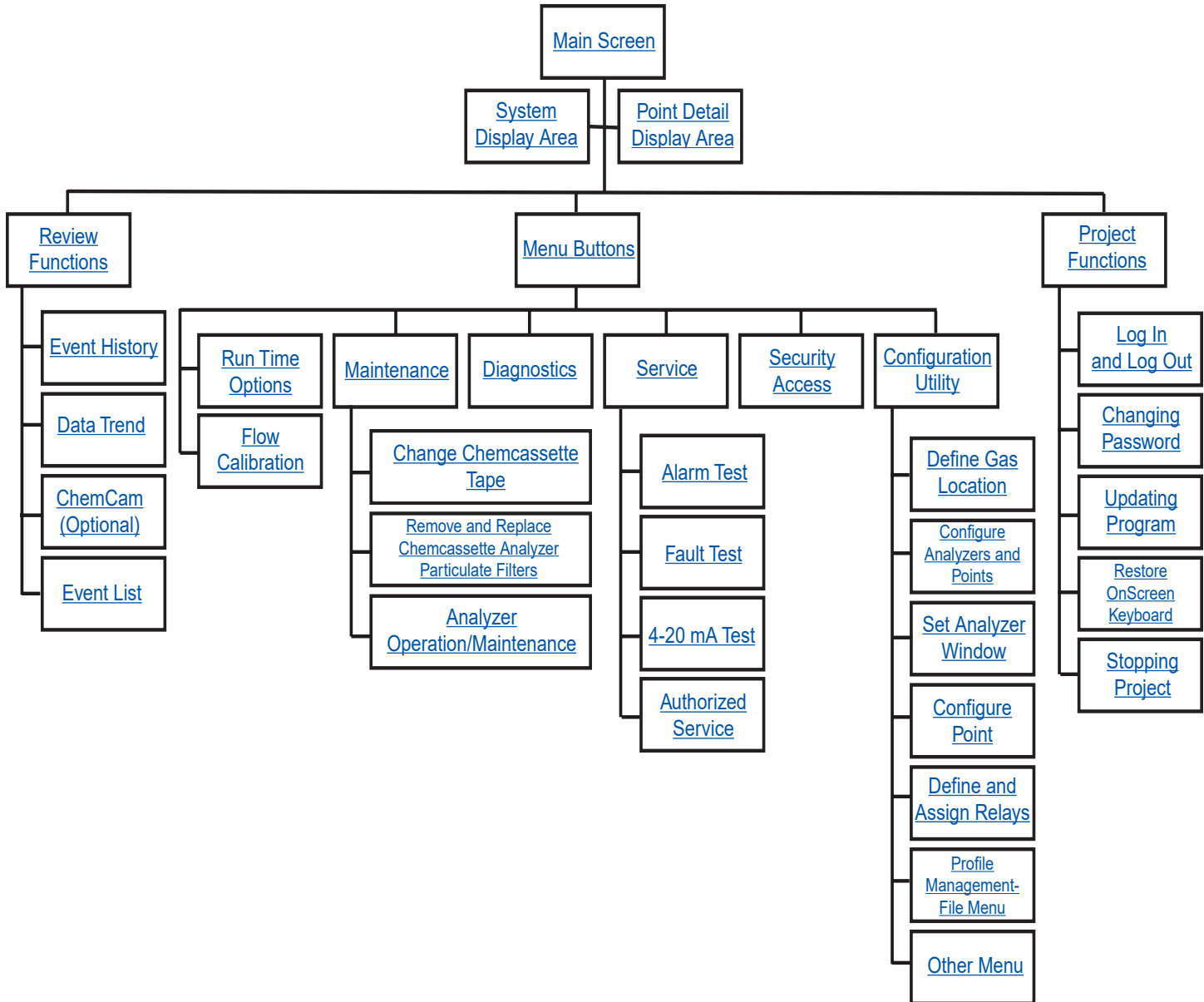

1.4 Analyzer Modules

The Vertex M System is populated with one or more types of analyzer modules. Each system may contain Chemcassette® modules or Pyrolyzer modules. Modules are installed in slots.

Tier 1	CC	CC	CC
	PYRO		
	Slot 1	Slot 2	Slot 3

Table 1-1. Module Tier Structure

Chemcassette® modules occupy one slot each. However, Pyrolyzer Chemcassette® modules are to be installed in slots 1 and 2. Pyrolyzer configuration and status information will appear in slot 2.

	Number of Points	Installed into Slots	Total Possible per Vertex M System
Chemcassette®	8	1, 2 or 3	3
Pyrolyzer	8	1 and 2 Only	1

Table 1-2. Required Slots

Examples of possible combinations in a Vertex M System:

- One, Two or Three Chemcassette® modules
- One Pyrolyzer Chemcassette® module
- One pyrolyzer Chemcassette® module, one Chemcassette® module

Your monitor will include only those modules specified at time of ordering.

1.5 Sampling System

Each Analyzer module is a monitoring center for sampling lines from sample locations. As they apply to the Vertex M System, the words point, line and location require definition:

- A location is a place to be monitored
- Sample atmosphere runs from the location to the Vertex M System via a line
- Each of the 24 sample tubing connections on the Vertex M System corresponds to a point. A sample line can be connected directly to a single point or multiple points via a 4-port manifold

The system draws air simultaneously from all locations. Two different types of flow are:

- Transport flow: high-velocity, large-volume air movement through the lines
- Sample flow: air admitted to the Chemcassette® detection system

The high speed of transport flow allows rapid monitoring and response time when using long lines from monitored locations to the Vertex M System. A small portion of the transport flow (sample flow) is analyzed to determine concentration levels.

The complete sampling and monitoring system consists of the following components:

- Sample lines to all monitored locations
- Flow connections through quick-connect ports in bulkheads on top of unit
- Moving cable and connectors
- Vacuum pumps
- Analyzers incorporating manifolds, Chemcassette® and filters
- Flow controlling proportional valve

- Top exhaust port

There are 24 inlets, one for each monitored location. One exhaust port is also located on top of the Vertex M cabinet.

1.6 Chemcassette® Detection System

The Chemcassette® Analyzer module is a self-contained, microprocessor controlled analyzer that occupies one slot in a Vertex M. Sample lines and the vacuum source are connected to the Chemcassette® via a single 10-tube connector.

The system powers up in the same state as when powered down. Data is stored in the module's memory until the data acquisition computer retrieves it.

The Vertex M Analyzer modules use the Honeywell Analytics' Chemcassette® optical detection system. Analyzer modules sample and detect a specific gas or family of gases.

- Each eight-point Analyzer module:
- Manages Chemcassette® tape transport
- Provides optical detection of stain
- Directs sample flow through the Chemcassette®
- Stores data for retrieval by the data acquisition computer

Components of the detection system include:

- Chemcassette® detection tape
- Optics and electronics for the detection system
- Chemcassette® tape transport mechanism
- Self adjusting proportional valves

1.6.1 Detector Optics

The heart of the Chemcassette® module is an optical

detection system that measures a stain that develops on the Chemcassette® tape in the presence of a target gas. Each eight-point Analyzer module has two detection heads, each with four individual detectors.

1.6.2 Stain Pattern

The following chart shows the stain pattern of sample detection on the Chemcassette® tape.

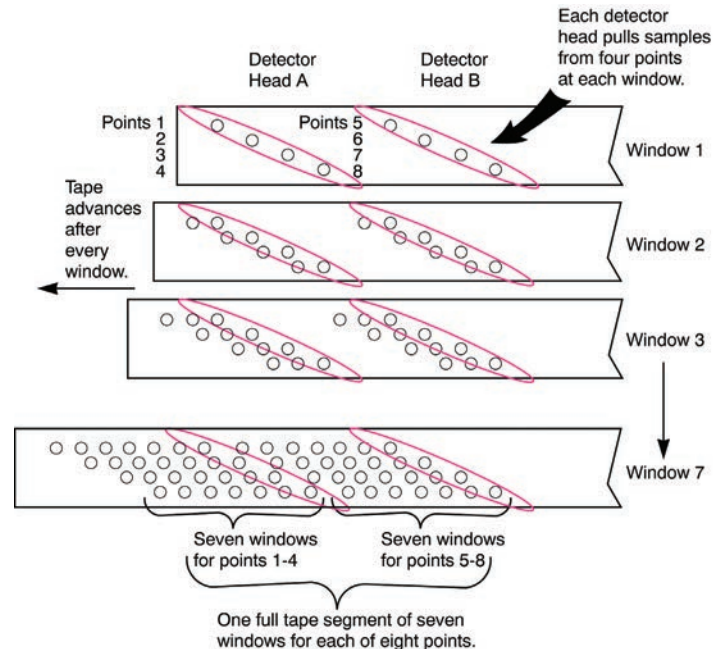

When monitoring a location, the system detects and measures a specific gas or a family of gases in the sample. The microprocessor in the analyzer module interprets the data and responds appropriately.

In the legacy detection system, the sample enters the inlet and passes through the Chemcassette tape to the sample outlet. The target gas in the sample flow reacts with the tape and produces a stain density proportional to the gas concentration. An LED in the detector head illuminates the sample stain and the detector then optically measures the stain.

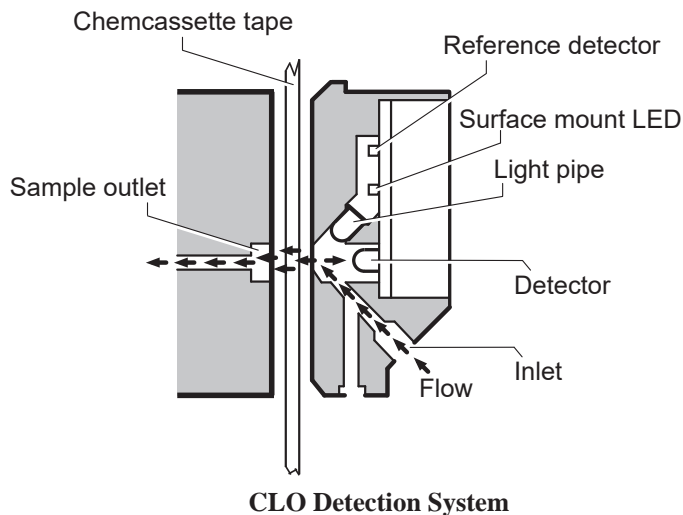
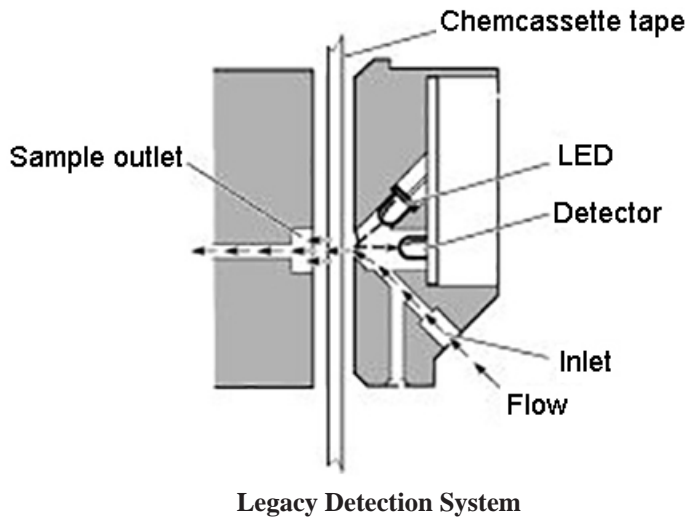

In the Closed Loop Optics (CLO) detection system, a reference detector monitors and controls the intensity of the LED.

The microprocessor in the Chemcassette analyzer module interprets the stain. It then calculates and stores a precise concentration level in the module's memory. Gas concentrations are reported in parts-per-million (ppm), parts-per-billion (ppb) or milligrams-per-cubic-meter (mg/m^3).

1.6.3 Chemcassette® Tapes

Chemcassette® tapes are tagged with a radio frequency identification (RFID) tag to automatically identify the following:

- Serial number
- Gas family/ tape type
- Revision level
- Expiration date of the tape
- Chemcassette® leader parameters

The module uses a leader on the Chemcassette® tape to allow calibration of the optics every time a new tape is installed. This feature can be bypassed.

1.6.4 Optional ChemCam

The ChemCam is a small video camera located between the take-up reel and the optic head on the module. It provides a means to observe alarm level stains.

1.6.5 Sample Filters

The Chemcassette® module includes three types of filters in the sample flow system. Particulate filters protect the internal precision orifice from dust particles. An acid filter is used on the common line to the pumps. Both types of filters are located in a removable filter block on the side of the Chemcassette® module. An internal particulate filter protects each proportional valve.

1.7 Pyrolyzer Module Detection System

The pyrolyzer module is similar to the standard Chemcassette® module except that it detects nitrogen trifluoride (NF₃). The sample passes through a high temperature heater (pyrolyzer) which converts the NF₃ to hydrogen fluoride (HF). The hydrogen fluoride is then detected with a standard or XPV mineral acids Chemcassette® tape. Detection is identical to the Chemcassette® module.

The correlation algorithm between HF and NF₃ is programmed into the module so the monitor displays the NF₃ concentration.

The Vertex M pyrolyzer module detects NF₃ only and cannot be bypassed to detect mineral acids.

The right filter compartment houses eight particulate filters and one acid scrubber, which are identical to the standard Chemcassette® filters. The left filter compartment houses eight charcoal filters which remove the following compounds:

Freon 12	Freon 113	HF
Freon 13	Freon 114	HCl
Freon 21	Freon 116	Cl ₂

Freon® is a registered trademark of E.I. du Pont de Nemours & Company (DuPont).

The charcoal filters may also remove other compounds. Contact Honeywell Analytics for a complete list. Charcoal filters have a part number (P/N 1874-0139) unique to the pyrolyzer module.

The Vertex M Pyrolyzer requires two adjacent slots on one tier and always occupies Slot 1 and 2. The bottom rail and latch must be removed from slot 1 to install pyrolyzer.

1.7.1 Pyrolyzer Fan

The Pyrolyzer has a fan that provides cooling to the pyrolyzer.

1.8 Vacuum Pumps

Two field-replaceable pumps provide a redundant vacuum source for the transport and sample flow system. One pump in the system draws vacuum while the other is idle. The pump exhaust connects to the manufacturing facility central toxic exhaust system.

Note:

The exhaust line from the Vertex M should not exceed 50 feet.

The pumps are located in the bottom of the Vertex M System cabinet inside a sound-deadening enclosure to reduce noise. Three cooling fans circulate air over the pumps.

The Vertex M System draws cooling air in through a filter mounted on the pump module access door.

Pump Status Indicator

See Pump Status Indicator under [Section 4.3.1 System Display Area](#).

1.9 Multiple Gas Monitoring

A Vertex M System equipped with two or more types of Analyzer modules can monitor more than one gas (or groups of gases such as hydrides or mineral acids) at a location.

Each Vertex M Analyzer module can monitor only one gas family (such as hydrides or mineral acids).

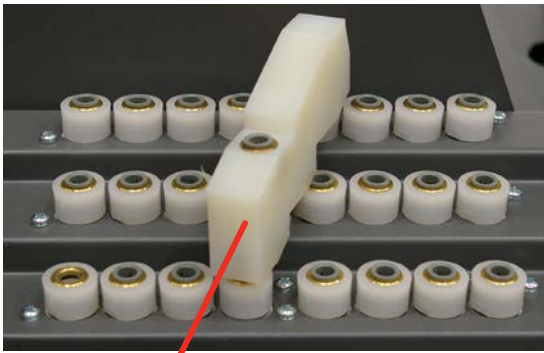

Optional manifold for multiple-gas monitoring.

1.10 Control System

The Vertex M control system is a redundant system consisting of a central data acquisition computer (DAq), a programmable logic controller (PLC) and one or more analyzer modules.

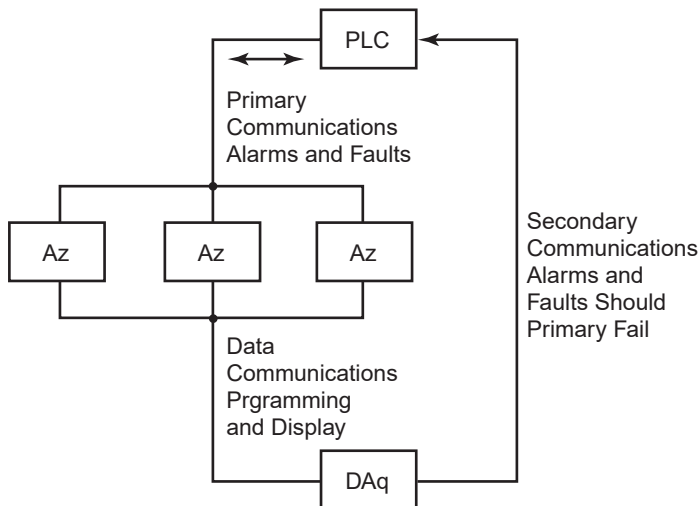

Figure 1-1. Communications Path

Above is a simplified block diagram of the communications path of the control system. The analyzer modules and PLC are microprocessor controlled and contain non-volatile memory.

1.10.1 Data Acquisition Computer

The data acquisition computer (DAq) is the central processor for the Vertex M System. It configures the analyzers, stores data and provides a network interface for data transfer to other computers. System display and operator control is through an LCD touchscreen w/ on-screen keyboard or included external keyboard.

CAUTION

OPC on TCP/IP via Ethernet not recommended for alarm annunciation.

1.10.2 Programmable Logic Controller

The Programmable Logic Controller (PLC) is the control system path between the DAq and the individual analyzers. The PLC polls the analyzers for current information, activates relays which may be connected to external alarms and provides external communications.

2 Installation

2.1 Introduction

The installation and initial start-up procedure for the Vertex M System consists of seven steps, described in this and the following sections:

- [2.2 Surveying the Installation Site](#)
- [2.3 Optional Floor Mounting](#)
- [2.4 Installing Sample Lines/Filters](#)
- [2.5 Installing Pump Exhaust Line](#)
- [2.6 Electrical Power](#)
- [2.7 Data Acquisition System](#)
- [2.8 Wiring Alarm Relays](#)

2.2 Surveying the Installation Site

A survey of the site helps you make important decisions before installing your Vertex M System. Topics in this section assist you with appropriate placement of the Vertex M System and in determining if you have special filtering needs at the sampling location.

The site should:

- Be remote from the monitored location, not sharing the atmosphere
- Have sufficient ventilation for cabinet cooling
- Have power available
- Be indoors in an area that is not subject to wide variations in temperature and humidity.

Note:

The specified humidity is 20–65% RH and a temperature between 59°F to 95°F (15°C to 35°C).

2.2.1 Placement of the Vertex M System

Install the Vertex M System in an environmentally-protected setting remote from the manufacturing or storage locations that it monitors.

Note:

Refer to the installation drawing in [Appendix A Installation Drawings](#) for lifting/mounting information.

You can place the Vertex M System up to 400 ft. (122 m) from sample locations.

2.2.2 Exposure to Dust and Humidity

Exposure to corrosive gases or materials, excess moisture, dust and other unusual environmental conditions could seriously hamper the Vertex M's monitoring ability and could damage the monitor.

Allow room around the Vertex M System for ventilation and servicing.

2.2.3 Sample Transport Time

Install the Vertex M System central to all 24 sample locations to achieve equal sample transport times during monitoring. The shorter the sample line, the shorter the response time. If monitoring a critical location, it may be desirable to place the monitor near that critical area to reduce sample transport time for that location. See [Appendix B Specifications](#) for transport times.

2.2.4 Monitor Dimensions

Monitor dimensions are important factors in monitor placement. The Vertex M System is 24. in. (61 cm) wide, 36 in. (91.4 cm) deep and 57 in. (144.8 cm) in height. The system with 3 analyzers weighs about 550 pounds (249 kg). Allow for 24 in. (61 cm) door swing; 5 in. (12.3 cm) at rear and 5 in. (12.3 cm) on sides. Allow clearance above monitor for installing sample lines.

2.2.5 Sample Locations

Before installing the Vertex M System, evaluate the sampling locations to determine if excessive dust or moisture are present. An external filter must be used in all locations. Make sure you use the correct filter. Dust may be a result of construction as well as manufacturing activities. Moisture may occur from rain entering a line at an outdoor sampling location or from

condensation caused by temperature fluctuations. Water condensation in the sample lines could cause false alarms.

Note:

Variables such as airflow, the molecular weight and temperature of the sample gas, and the physical conditions of the areas being monitored influence the placement of the sampling locations. You may need to consult your company's industrial hygienist or safety officer before installing sample lines to determine your company's policy related to sampling locations and monitoring of the desired sample gas.

2.2.6 Sample Line Particulate Filter Use

See [Appendix B Specifications](#) to determine which filter type should be used at the location.

2.3 Optional Floor Mounting

For added protection with optional floor mounts, prepare floor anchors to secure the base of the cabinet and prevent tipping. See [Appendix A Installation Drawings](#) for floor mounting instructions.

2.4 Installing Sample Lines/Filters

Use only FEP Teflon® tubing to assure proper sample transport. Other types of tubing are not sufficiently inert. See [Appendix B Specifications](#) for tube specifications. FEP tubing can be ordered from Honeywell Analytics. This tubing is manufactured to our own strict specifications, and has been purged of all by-products of the manufacturing process. On occasion, users have supplied their own FEP type tubing. Should you choose to use your own tubing, be advised that some brands of FEP tubing off-gas small amounts of HF, which can be detected on start up by monitors configured for detecting mineral acids gases (HBr, HCl, HF, NF₃). Before enabling building alarm systems, make certain that 1) you have installed the

correct Chemcassette® and 2) your monitor reads zero.

Install sample lines from each location to the top of the Vertex M System. This procedure involves:

- [2.4.1 Sample Line Installation Requirements](#)
- [2.4.2 Sample Line Connections](#)
- [2.4.3 Installing Sample Line Particulate Filters](#)

Teflon® is a registered trademark of E.I. du Pont de Nemours & Company (DuPont).

2.4.1 Sample Line Installation Requirements

Follow the general requirements listed below when installing sample lines.

- Sample lines should not exceed 400 ft. (122 m) in length.
- Route all lines as direct as possible to improve transport time. See [Appendix B Specifications](#) for transport times.
- Avoid running sample lines through areas of great temperature extremes, such as adjacent to steam or chiller lines.
- Sample lines should not be crimped, bent to less than a 12 in. (30.5 cm) radius, or placed in an area where weight could collapse the tubing. Sample lines should be easily accessible for periodic inspection.
- Where possible, leave as many bends exposed for periodic visual inspection of the line for kinked or damaged tubing.
- Check each sample line installation for seal integrity after completing installation of the Vertex M System. See [Section 3.8 Leak Checking Sample Lines](#) for the leak check procedure. Also use this procedure to detect leaking or severed tubing after events, such as construction, which may have affected the

integrity of the tubing.

- Unused sample line ports should have a particulate filter installed to keep the system clean.
- If an analyzer is installed in the Vertex with a Chemcassette tape, the optics may need cleaning before activating a previously unused point.

2.4.2 Sample Line Connections

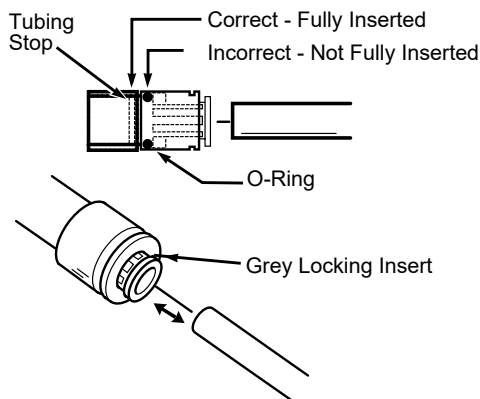

Figure 2-1. Sample Line Inlet Connections

To prepare for installation of sample lines, remove the FEP Teflon tubing from the installation kit. The top of the unit includes 25 connections:

- 24 Sample Inlets
- Exhaust Outlet (See [Section 2.5 Installing Pump Exhaust Line](#) for connection.)

Note:

Always perform a leak check after installing sample lines. See [Section 3.8 Leak Checking Sample Lines](#) for the leak check procedure.

Each inlet has a quick connect/disconnect fitting with an internal O-ring and an external grab ring. To

install a tube into a sample line inlet, insert the tube far enough into the fitting to ensure that the tube has passed through both the external grab ring and the internal O-ring and is firmly seated against the stop. The insertion depth for a correctly installed sampling line is 1/2 in. to 5/8 in. (12 mm–16 mm). Verify the insertion depth by holding the tube and marking with your thumb where it emerges from the fitting. Remove the tube to measure the insertion depth.

⚠ CAUTION

Improper installation of the tube into the connector results in dilution of the sample.

2.4.3 Installing Sample Line Particulate Filters

Attach a sample line filter to the sampling end of the line for all locations.

⚠ CAUTION

Keep in mind that excess amounts of dirt in the filters reduces the sample flow, raises sample vacuum and may affect concentration readings of the analyzer.

See [Appendix A Specifications](#) to determine the proper filter type to use with each target gas.

2.5 Installing Pump Exhaust Line

This section describes exhaust connections and installation. The Vertex M System is equipped with a vacuum pump that is located in the bottom of the Vertex M System cabinet. The pump exhaust line connects to the manufacturing facility central toxic exhaust system.

2.5.1 Exhaust Line Installation Requirements

Follow the general requirements listed below when installing exhaust lines.

The length of the line should not exceed 50 ft. (15 m). If longer distances are required, contact Honeywell Analytics.

Do not crimp exhaust lines, or place them in an area where weight could collapse the tubing, or bend them to less than a 12 in. (30.5 cm) radius.

Where possible, leave as many bends exposed for periodic visual inspection of the line for kinked or damaged tubing.

Varying exhaust pressure can induce pump failure or flow faults.

2.5.2 Exhaust Line Connection

The monitor includes 20 ft. (6m) of 3/8 in. (10 mm) I.D. x 1/2 in. (13 mm) O.D. Teflon tubing. Insert the tubing into the exhaust port on the top of the unit to the depth of 0.9 in. (23 mm).

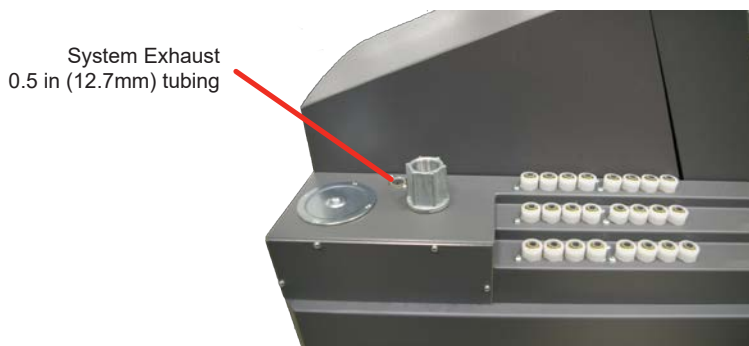

CAUTION

Leaks in the exhaust tubing connection can cause exposure to toxic gases from remote sample areas.

To ensure a leak-free installation:

- Use a polypropylene tube with outside diameter 0.375 in. (9.525mm) +/-0.005 in. (0.127mm).
- Verify that the external surface of the tube is free of score marks and scratches that could compromise the O-ring seal used in the fitting over the insertion depth.
- Cut the tube end perpendicular to its length 0.062 inches (1.5 mm) from its end.
- Insert the tube in the fitting to a depth of 0.95 in. (24.13mm) ±0.05 inches (1.27mm)

With the system running, verify the leak integrity with a small amount of leak test fluid.

2.6 Electrical Power

The Vertex M System requires a connection to a source of electrical power. An easily accessible service disconnect/power switch must be installed near the instrument, and the switch must be marked as the main disconnect for the Vertex M unit. The following warning must be displayed at the switch:

WARNING

Hazardous voltages may exist at the Alarm Contacts in this unit with the power switch turned off. Ensure power is disconnected at the source prior to servicing alarm contacts.

2.6.1 Connecting AC Power

AC Source Requirements:

- Operating Voltage: 110 or 230 VAC \pm 10% (under load) @ 50/60 Hz; 15 Amps maximum, single phase.

The Vertex M System requires a dedicated AC circuit rated at either 110 or 230 volts, 50/60 Hz, 15 Amp single phase. Line voltage should fluctuate no more than \pm 10%. The external switch must be clearly labeled and installed in accordance with local electrical codes. Input power cable should be #14 AWG minimum. The safety ground wire must be the same or larger gauge as the line wires. Connect AC power connection to the three-position terminal block in the side panel of the rack.

See Figure 2-2.

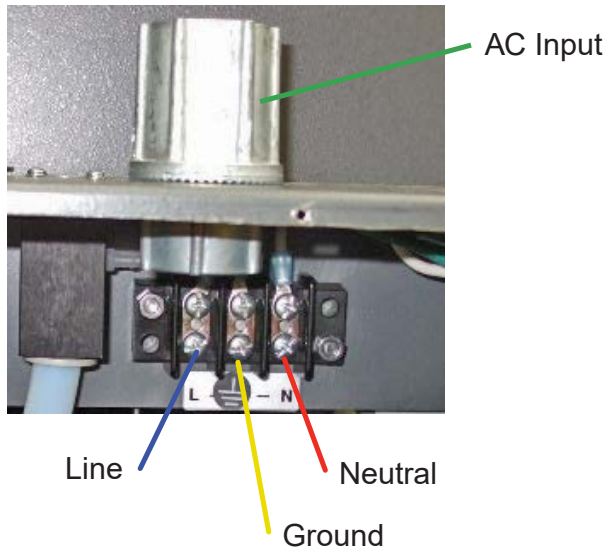

Figure 2-2. AC Power Connection

2.6.2 Power On/Off

An internal rack power switch is located behind the door.

After performing self-diagnostics, the Vertex M System main screen opens and the system returns to the same state it was in prior to power down.

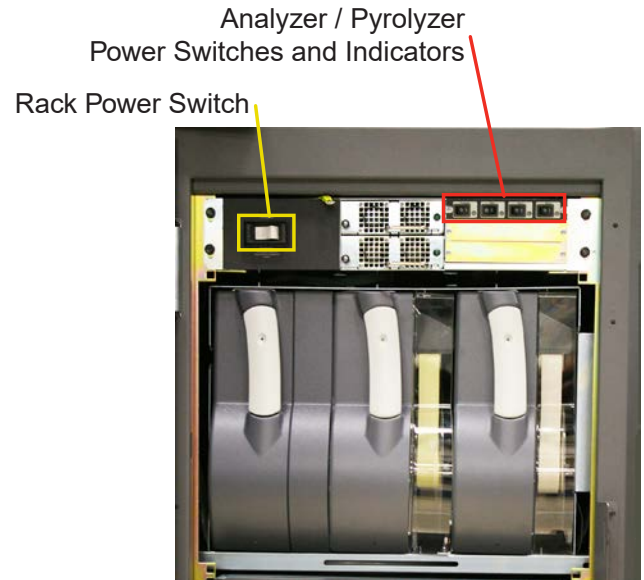

Figure 2-3. Rack Power Switch

WARNING

Hazardous voltages may exist at the Alarm Contacts in this unit with the power switch turned off. Insure power is disconnected at the source prior to servicing alarm contacts.

2.7 Data Acquisition System

The data acquisition computer or DAq is the main computer in the Vertex M System. System display and operator control are through an LCD touch screen with on-screen keyboard or the external keyboard on top of the unit.

The on-screen keyboard operates similar to a standard keyboard except when using modifier keys (CTRL, ALT, or SHIFT).

To use modifier keys:

1. Touch the modifier key. The key changes to show the modifier key is locked down.
2. Press the second key of the key combination.



Figure 2-4. On-screen Keyboard

2.7.1 Printer

The Vertex M System software can be programmed to print to either a network or local printer. To install a local printer, connect it to the parallel printer port as shown. You may also use the USB port. The correct printer driver must also be installed.

Parallel Printer Port USB Port



Figure 2-5. Printer Connection

2.7.2 External Network Connection

The Vertex M System can be connected to an external Ethernet network at the port shown.

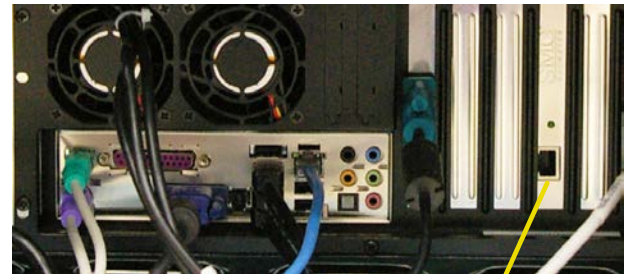

External Ethernet Connection

Figure 2-6.

CAUTION

Do not connect an external network to the Vertex M Ethernet hub. Use only the external Ethernet connection (as shown in Figure 2-6) on the back of the data acquisition computer. Connecting an external network to the hub will impair monitoring capability.



Figure 2-7. Ethernet cable

1. When using an Ethernet output, the conduit must be connected to Earth ground.
2. The Vertex M comes with a Ferrite. Four wraps of the Ethernet cable is needed as close to the Vertex M as possible.

2.7.3 Network Computer Security

The Vertex M relies on the HMI system of accounts and passwords to prevent unauthorized tampering as described in [Section 4.6.6 Security Access](#) of this manual. Microsoft® Windows® provides its own system of accounts and passwords. However RSVIEW32 requires that Windows be run in an account with administrator privileges. Attempting to run the Vertex M RSVIEW32 application in a Windows® account without administrator privileges will cause error messages to be displayed. The Vertex M should be treated and secured as any other networked PC by maintaining the appropriate virus protection. Contact your local Honeywell Analytics field service representative prior to installing Microsoft updates or Service Packs

Use an external hardware firewall to isolate the monitor from malicious Ethernet traffic.

2.8 Wiring Alarm Relays

This section describes relay:

- Contacts
- Ratings
- Wiring guidelines

WARNING

Use caution when servicing the PLC terminal blocks. Power to contacts is supplied externally. See [Appendix A Optional Relay Specifications](#) for alarm relay voltage and contact rating guidelines.

2.8.1 Relay Contacts

The Vertex M System has form-A, single-pole, single-throw relays that activate external alarm devices. Contacts are available for each circuit to accommodate installation of external devices.

Relay panels are located behind the Vertex M LCD screen. See [Appendix A Optional Relay Specifications](#) for more information.

2.8.2 Wiring Guidelines

To wire the alarm relays:

- Use agency approved wire (such as NRTL in the U.S.) with 300 volt insulation.

CAUTION

Make sure there is proper separation between the mains power supply and alarm wiring.

- Route relay wiring through raceway and out through the top of the cabinet.
- Use shielded cable or conduit.
- Conduit must be earth grounded.

CAUTION

Failure to replace and retighten hardware after servicing can adversely affect monitor performance and EMC compliance. Make certain all fasteners are reinstalled and firmly tightened. This will ensure a proper ground.

- Use a single, solid or stranded wire (not exceeding 14 gauge or 2.5 mm²) per terminal block connection.
- Do not switch DC current with the relay contact unless you are using counter electromotive force (CEMF) protection such as a suppression diode.
- Do not use the Vertex M System power supply for external alarm power.

Note:

Make sure all connections comply with applicable RFI/EMI standards.

Alarm Wiring Conduit Plate
2 in (50.8mm)



Note:

The Alarm wiring conduit plate must remain in place if not used.

Validating the System

The Vertex M and Chemcassette products' design, manufacture, and recommended maintenance ensure the correct operation of the system. For validation or commissioning after installation by gas exposure, these Technical Notes are available upon request from Honeywell Analytics:

1998-0837 *Calibration and Verification*

1998-0219 *Detector Testing Protocols*

3 Startup

3.1 Startup

This section describes the Vertex M System startup sequence.

3.1.1 Initial Startup

Use this section to turn on your Vertex M System and to configure the analyzer modules for specific gas locations. There are six parts to this startup procedure:

- [3.3 Verify Installation](#)
- [3.4 Power Up](#)
- [3.5 Start Program](#)
- [3.6 Configuration Utility](#)
- [3.7 Load Tape](#)
- [3.8 Leak Checking Sample Lines](#)
- [3.9 Verify Flow Rates and Supply Vacuum](#)

3.1.2 Factory Configuration

Honeywell Analytics loads all software on the DAq at the factory. The Universal Chemcassette® Analyzers are configured for the mineral acid family of gases and the Pyrolyzer Analyzers for NF_3 . You will need to configure each point for the target gases at your facility.

3.2 Getting Started

Before startup and configuration, gather the following information:

- The location to which each point is connected
- Target gas at each location
- Alarm levels
- Relay configuration

3.3 Verify Installation

Ahead of the startup sequence, make sure that the following installation steps have been completed:

- Sample lines
- Exhaust line
- AC power connection
- Relay wiring

See [Section 2 Installation](#) for connection details.

3.4 Power Up

Use the rack power switch behind the front door to power up the Vertex M System.

1. Open front door.
2. Turn on rack power switch.
3. Turn on power switch to appropriate analyzers.
4. Close and latch front door.

After 15 seconds, the analyzer status LEDs sequence four times through all colors.

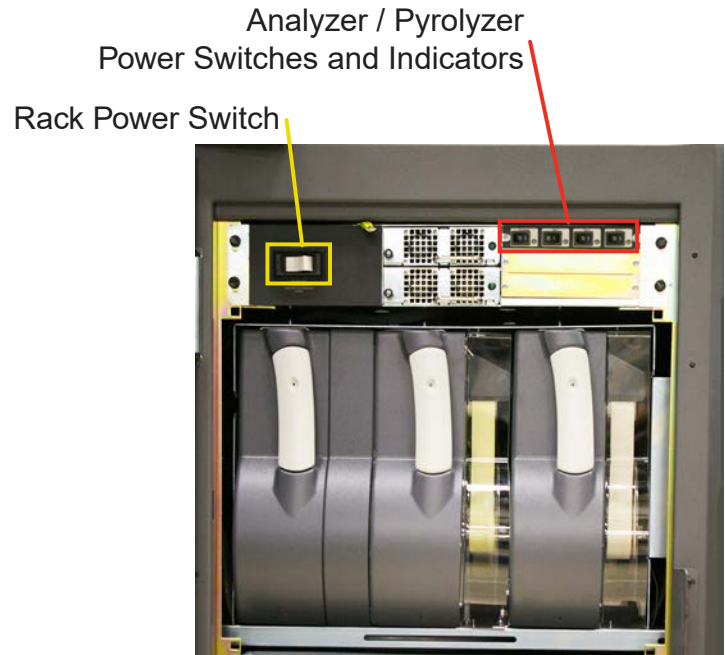

Mon State	Alarm State	Fault State	time in millesconds									
			500				400				100	
idle	0	none	black							green		
		maintenance	amber							black		
		instrument	amber				black					
	1	any	red							black		
	2	any	red				black					
pyrolyzer warmup	0	none	green				black					
		m or i	green				black		amber			
	1	any	green				black		red			
monitoring	0	none	green							black		
		maintenance	amber							green		
		instrument	amber				green					
	1	any	red							green		
	2		red				green					
primary program invalid			amber	black	amber	black	amber	black	amber	black	amber	black
unpowered			black									
lockup			green									
			amber									
			red									

Table 3-1. Analyzer Status LEDs

3.5 Start Program

Upon power-up, the DAq automatically starts Windows and loads the Vertex M program. After the two-to-three minute startup sequence, the Vertex M main screen opens.

Note:

Any time the Vertex M System is powered up, loss of communications may cause maintenance faults.

See [Section 4.5.4 Event List](#) for instructions to clear faults.

Note:

Use the Windows Date/Time Properties dialog box to change the time zone, time and date on your Vertex M System. Stop project if adjusting time and time zone. Once complete restart project. See [Section 4.4.5 Stopping Project](#) on how to stop the project.



CAUTION

Do not change language in Windows setup.



Figure 3-1. Vertex M Main Screen

3.6 Configuration Utility

Before the Vertex M System can begin monitoring, you must create a configuration profile. The configuration profile stores all of the monitor settings in a single file on the hard drive. Configuration profiles include system level information, point settings and analyzer information. Use the Configuration menu to create a new configuration profile or modify an existing profile.

To open the Configuration Menu, touch Main Screen, Menu and then Configuration.

Set Initial Configuration

Enter information and set parameters common to all points and modules.

Configure Analyzer / Points

Defines the type of analyzer module installed in each slot. Designates the target gas. Sets alarm levels for each point.

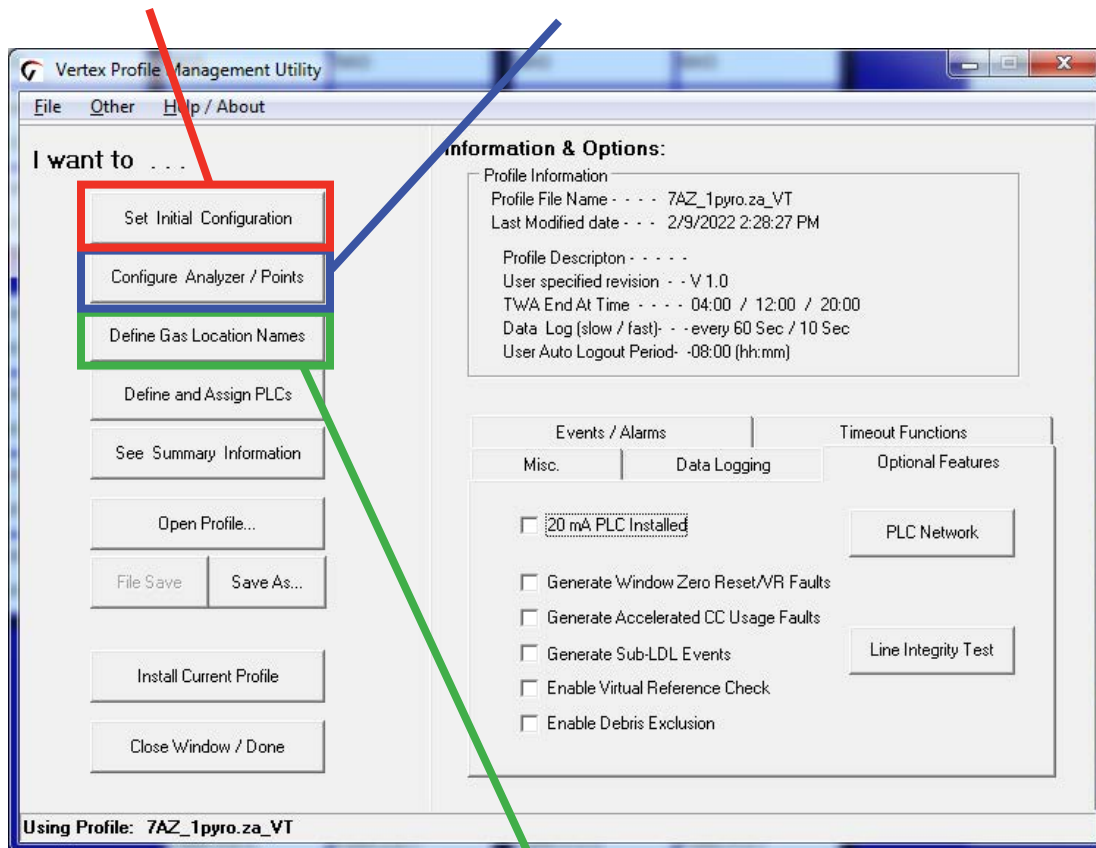

Define Gas Location Names

Enter the short and long names for each monitored location.

Define and Assign PLCs

Associate relays with software alarms and faults.

Information and Options

A display of key parameters about the Vertex M system.

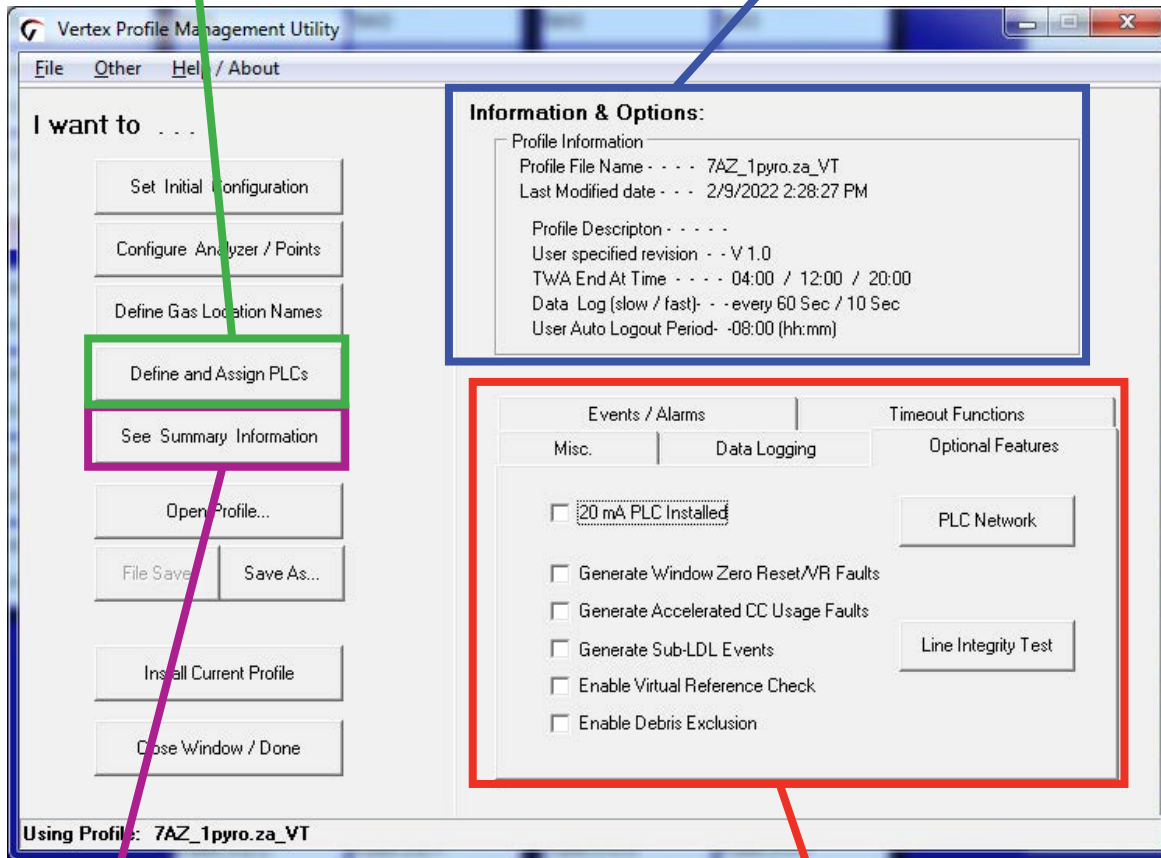

See Summary Information

A tabular listing of the configuration profile

Options

Select a tab to enter information and set parameters common to all points and modules.

Install Profile Status

During the installation process, a dialog box will be shown indicating the status and final result of the installation.

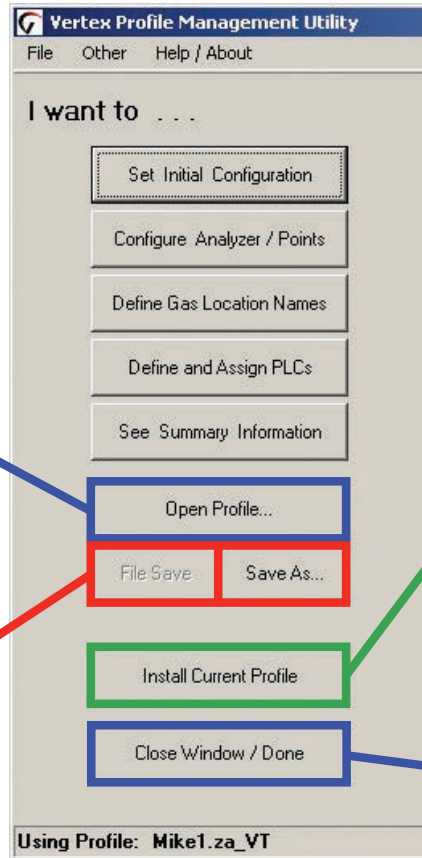

Open Profile...

Opens a previously saved profile.

File Save/Save As...

Saves current profile on disk. Vertex M will prompt you to save changes when closing the Configuration window.

Install Current Profile

Not active while creating configuration profiles on a computer other than the one running the Vertex M system. Loads the current configuration settings into the appropriate analyzers and PLCs. If the Vertex M System is in a monitoring state, the program will open a dialog box to verify that it is okay to take the Vertex M System out of monitor during the profile installation.

Close Window/Done

Exits Configuration setup

Non-Latching Gas Alarm Relays

A latching gas alarm relay activates when a gas concentration reaches a level 1 or level 2 alarm setting. The relay remains activated until an authorized operator resets the alarm. Non-latching gas alarm events clear themselves as soon as the gas concentration drops below the alarm setting.

All events require User Ack

When selected, non-latching alarm events will not be removed from the event list until an authorized user acknowledges the event. Fault and latching alarm events are not affected by this option, since an authorized user must reset these events and a reset also serves as an acknowledgement.

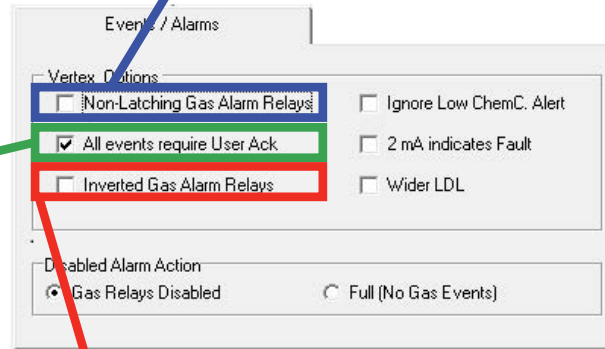

Inverted Gas Alarm Relays

Vertex M alarm relays, by default, are normally open (de-energized) when no alarm condition exists. If this option is checked, the alarm relays will be normally closed (energized) when there is no alarm. Fault relays are not affected by this option and are always normally closed (energized) unless a fault condition exists.

Ignore Low ChemC. Alert

Vertex M software tracks the amount of Chemcassette® tape remaining on the supply reel and triggers a low tape event when less than 24 hours of tape remain.

Choosing “Ignore Low ChemC. Alert” disables the low tape event.

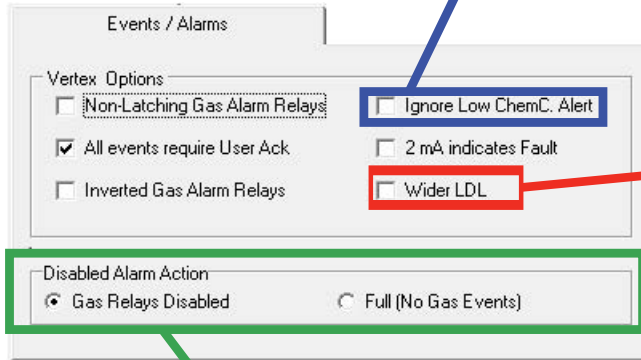

Wider LDL

Enabling Wider LDL will allow users to set point LDL range from 0 to TLV

Disabled Alarm Action - Gas Relays Disabled or Full (No Gas Events)

This setting effects the operation when alarms are disabled using the Runtime Options screen. If “Full” is selected, Vertex M will not generate an alarm event for the affected point(s) and none of the associated actions such as relay actuation will occur. Otherwise, the alarm events will be generated normally when using data output options but, the alarm relays ONLY will not be activated in response to the event. When utilizing data output options, it is highly

Internal Filter Life (in Days)

Set the number of days the filters will last before they need to be replaced. When the target is reached, this setting will trigger a maintenance fault to replace filter.

Set Timeout Values

Authorized users may temporarily disable alarms from activating and points from monitoring. A point or alarm that is disabled longer than the timeout limit will cause a maintenance fault which will call attention to locations excluded from monitoring. Enter a period of time up to displayed minutes or 0 to disable the maintenance fault.

User Specified Auto Logout

Users remain logged in until the auto logout period lapses. The auto logout period ranges from 30 minutes to 24 hours. A warning displays prior to auto logout.

The screenshot shows the 'Timeout Functions' menu with three highlighted sections:

- Set Timeout Values (Red box):** Contains three rows: 'Disabled Alarm (0 - 240 min)' with a value of 60, 'Disabled Point (0 - 240 min)' with a value of 60, and 'Az Out of Mon. (0 - 60 min)' with a value of 60.
- Internal Filter Life (in Days) (Green box):** Contains a 'Disable Filter Life' checkbox (unchecked), a spinner control showing '090', and the label 'Monitoring Days (1 - 180)'.
- User Specified Auto Logout (Blue box):** Contains a spinner control showing '08:00' and the label 'Hours : Minutes (by 30's)'.

Data Logging

Slow / Fast Logging Rate

Log once every Slow rate

Fast Rate

DB Mgmt

Enter 1st TWA time of the day

1st TWA Time

Use to set times for the beginning and end of each 8-hour, Time Weighted Average (TWA) period. Use this option to associate the TWA periods with shifts or any other regular event. The system calculates and displays the TWA after each 8-hour TWA cycle.

The default setting is 04:00 indicating that the Vertex M will run three successive TWA periods from 04:00 to 11:59, 12:00 to 19:59, 20:00 to 03:59. Remember, the Vertex M System uses a 24-hour clock. For example, to set the first TWA to 3:00 P.M., enter 15:00. If you view the profile information for this example, you will see the TWA End At Time is 07:00/15:00/23:00. The system automatically sets the beginning times of the second and third TWA periods at 8-hour intervals from the time entered for the first TWA period.

DB Management

Sets the time period to maintain historical event and concentration data before purging. Set the purge period in Database Management to prevent a large number of records to accumulate.

Logging Rate

The Logging Rate option sets the frequency that Vertex M enters gas concentration data into the database. The system logs data at a slow rate unless a gas concentration rises above the threshold set in the point configuration window. Once the concentration reaches the threshold, Vertex M logs at a faster rate. Logging period options are 5, 10, 30, 60, or 120 seconds for the slow rate and 5, 10, 15, 20, 30, or 45 seconds for the fast rate. (See Section 3.5.4, Configure Point, for instructions to set logging frequency.)

Data Logging

Slow / Fast Logging Rate

Log once every 5 Sec Slow rate

20 Sec Fast Rate

Enter 1st TWA time of the day

12:00

DB Mgmt

Note:

Setting the Vertex M System to continuously log concentration data on a 3-analyzer system requires approximately 15 megabytes of disk storage per day at the fastest logging rate of once every 5 seconds. Purge data often to avoid filling available disk space.

Database Management-Retention Periods

Retention periods are selected as either days or weeks. Valid entries for the period are positive numbers from 1-99. Vertex M will not recalculate the values when the unit is changed. For example, if the purge period is 14 days and you change “days” to “weeks”, Vertex M will set the period to 14 weeks. Vertex M performs the record purge as the data acquisition computer clock passes midnight.

Event Record Retention Period

When selected, Vertex M automatically purges events from the database after the designated period.

Logged Data Record Retention Period

When selected, Vertex M automatically purges concentration records from the database after the designated period.

The screenshot shows a dialog box with two panels. The left panel, titled "Event Record Retention Period", has a checkbox for "Purge Records from database" which is unchecked. Below it, the text reads "Auto Purge Records older than 26 weeks". There is a text input field containing "26" and two radio buttons: "Days" (unchecked) and "Weeks" (checked). The right panel, titled "Logged Data Record Retention Period", has a checkbox for "Purge Records from database" which is checked. Below it, the text reads "Auto Purge Records older than 45 days". There is a text input field containing "45" and two radio buttons: "Days" (checked) and "Weeks" (unchecked). At the bottom of the dialog are "OK" and "Cancel" buttons.

20 mA PLC Installed

Leave this box UN-checked regardless of whether a 4-20mA PLC is installed. See [Appendix G](#) for Analog Output option configuration.

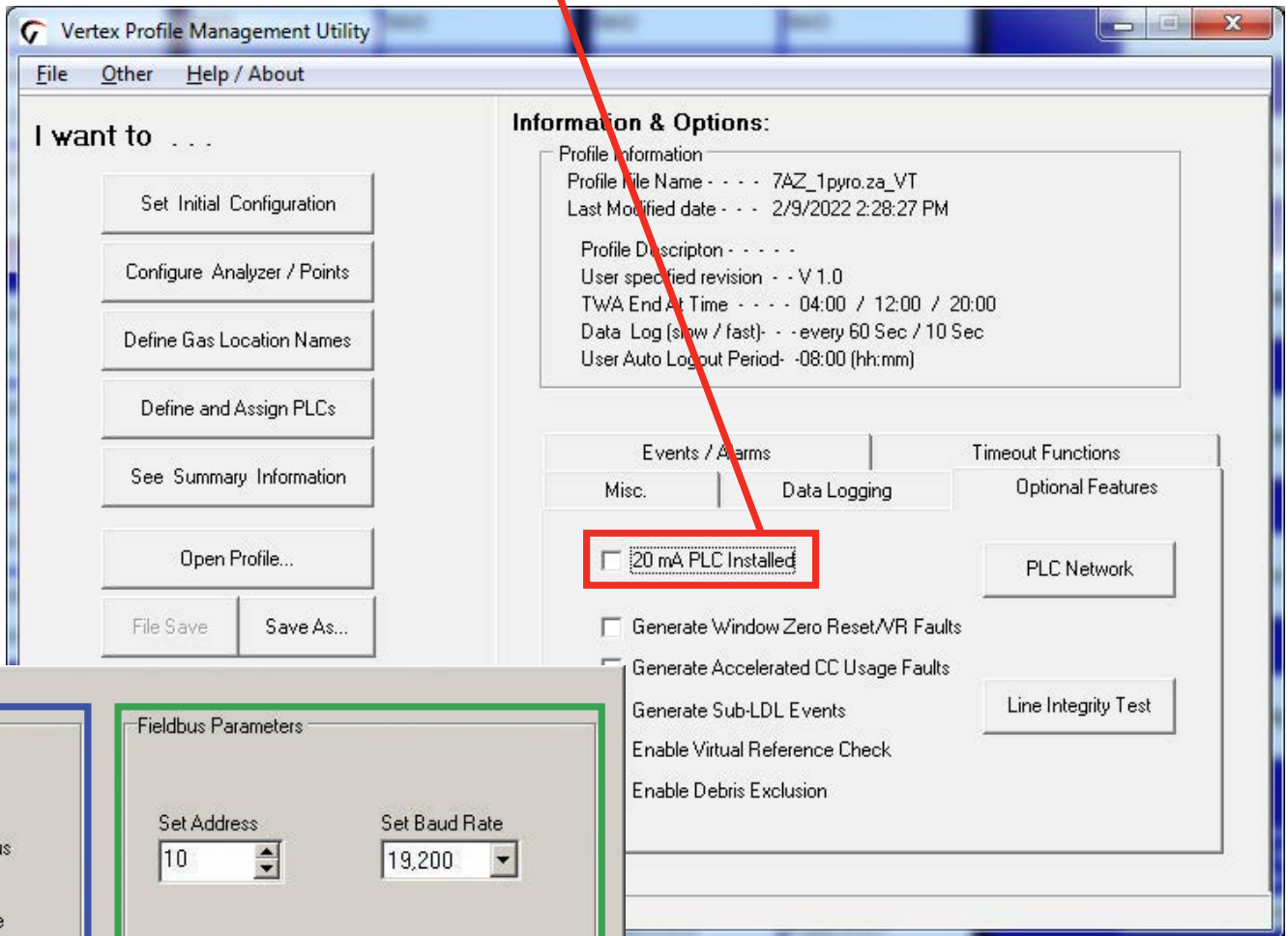

Fieldbus

Use this setting to select the PLC network interface that is installed.

Fieldbus Parameters

These settings allow the user to change network specific parameters such as address and baud rate.

Use mg/m3 units
Select to display concentrations in milligrams per cubic meter. If this option is not selected, Vertex M displays concentrations in parts-per-million (ppm) or parts-per-billion (ppb).

Profile Description
Enter a descriptive name for the configuration profile. You may use up to 32 characters.

User File Rev
Allows the user to assign a revision number to a configuration profile. The profile revision number is not associated with software version numbers.

Misc.
 Use mg/m³ units
Enter User Profile Information
User supplied desc. (32 chars)
V 1.3 User specified Profile File revision

3.6.1 Define Gas Location

Use Define Gas Location to edit the list of locations. Assign a long and a short name for each location.

Clear All Entries

Clears every entry in the list.

Add New Entry

Creates a new entry in the gas location list using the entered short and long names.

Short names

Enter up to 12 characters. Vertex M displays the short name where space does not permit the display of the long name.

Long names

Enter up to 35 characters.

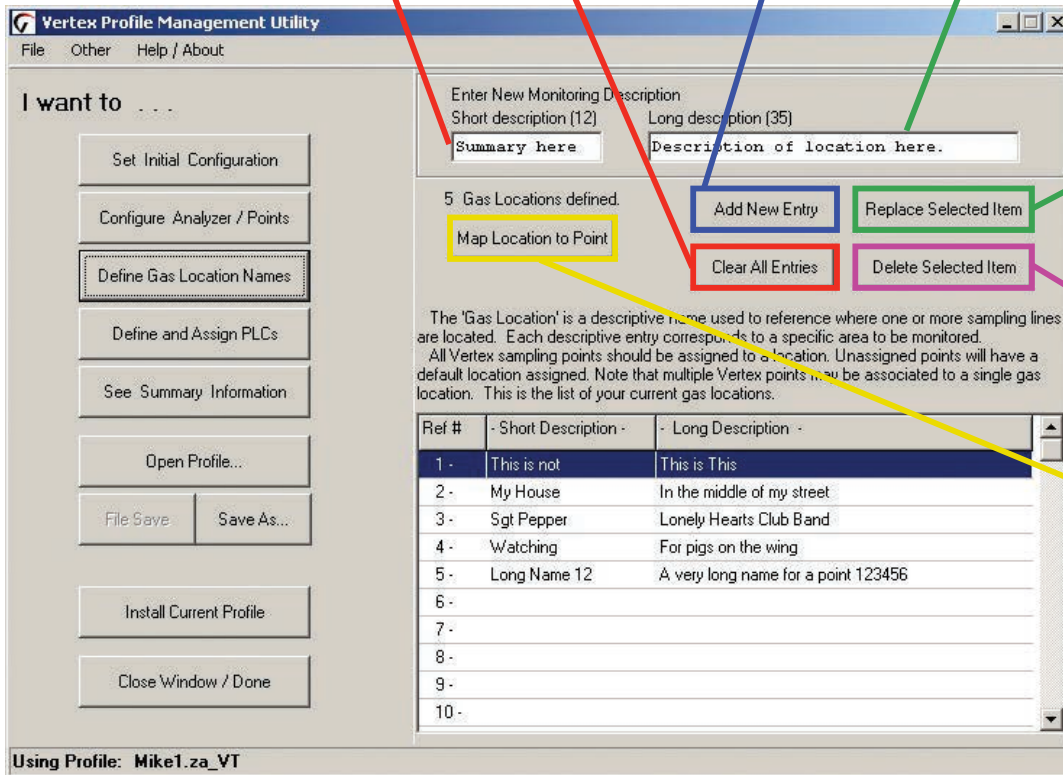

Replace Selected Item

Replaces the selected line in the gas location list with the information in the short and long name text boxes.

Delete Selected Item

Removes the selected line from the location list.

Map Location To Point

Brings up Location Map window.

Gas Location List

Select desired gas location from this list.
For points with no assigned location, select (default). Points assigned to default location will automatically be given location names based on the point's position in the Vertex M.

Point Map

Select point to add or remove it from the selected location. Up to 3 points can be assigned to each location.

Vertex Profile Management Utility

File Other Help About

Map Gas Location to Analyzer Points

(default)
Gas Cabinet 1A
Tool 3C
Lab 2F

Done

Close Window / Done

Using Profile: VertexConfig.za_Vt (modified)

Tier 1

Analyzer-1 Analyzer-2 Analyzer-3

P1 P5
P2 P6
P3 P7
P4 P8

Tier 2

Analyzer-1 Analyzer-2 Analyzer-3

P1 P5
P2 P6
P3 P7
P4 P8

Tier 3

Analyzer-1 Analyzer-2 Analyzer-3

P1 P5
P2 P6
P3 P7
P4 P8

3.6.2 Configure Analyzers and Points

Press “Configure Analyzer/Points” to change the right side of the Configuration window to a display representing physical layout of the Vertex M System. Each slot is represented by a two-part button.

When you have configured an analyzer, the top of the button displays the type of analyzer and the gas family. The bottom of the button is a second button for configuring each point within the analyzer.

Note:

Only analyzers on tier one should be configured. Configuring analyzers on tiers 2 or 3 will result in errors and faults.

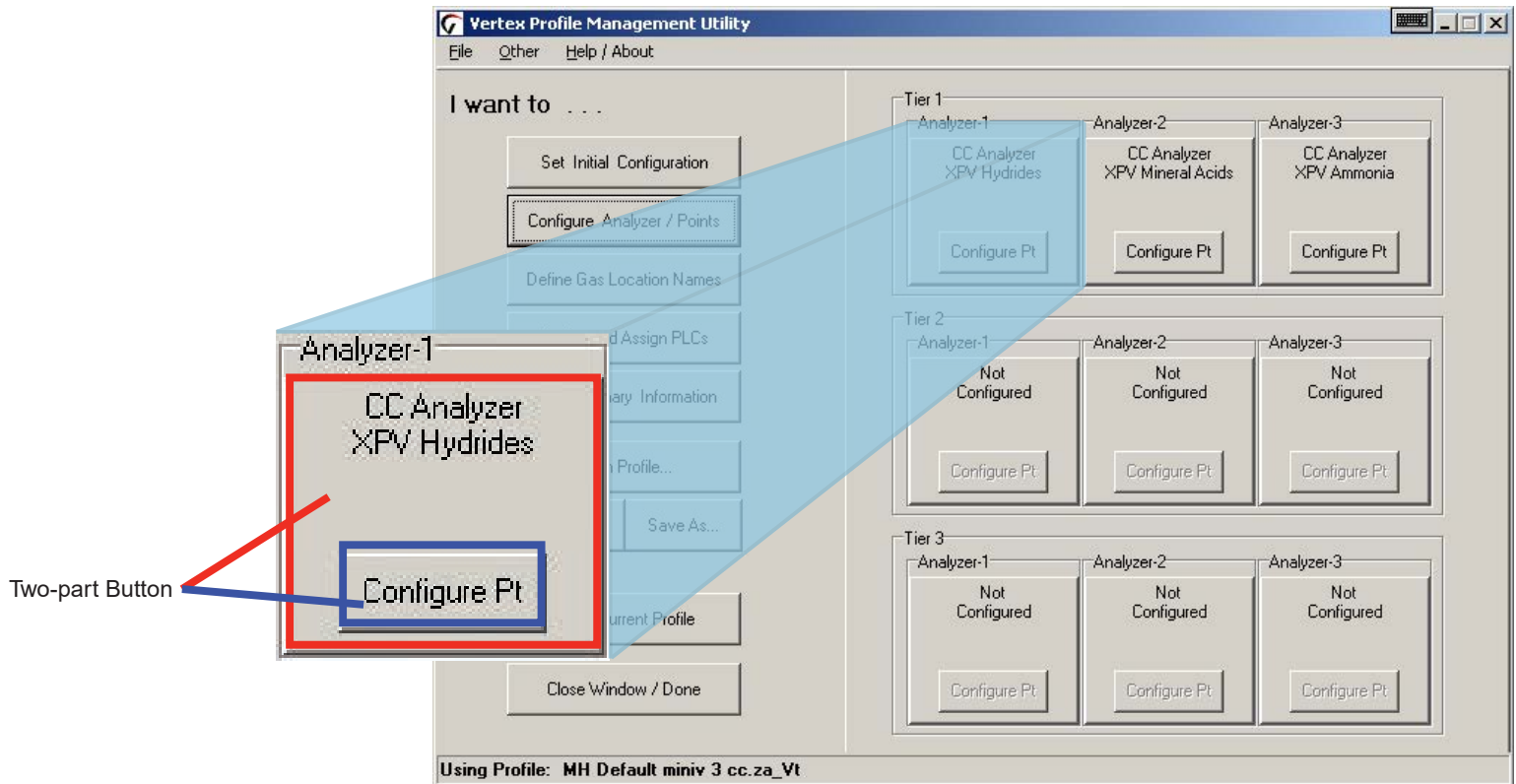

3.6.3 Set Analyzer Window

To configure the type of analyzer slot, press the top of the button representing the slot. The Set Analyzer Window opens.

Analyzer Type
Choose the model of analyzer populating the slot. A pyrolyzer takes up slots 1 and 2. If pyrolyzer is selected, slot 1 automatically becomes unavailable.

Any analyzer that is physically installed but configured on this screen to "None" should be de-energized.

Family/Chemcassette
Choose the family of target gases. Target gases for all eight points in the analyzer must be in the same family of gases.

Options
When you choose a family of gases, Vertex M enters default settings into the profile. Selecting "Override Defaults" allows you to change the target gas type, alarm levels and the location assignment.

ChemCam AutoPicture
If the optional ChemCams are installed, select under what condition a picture of the Chemcassette® stain will be automatically taken.

ChemCam AutoPicture

When either ChemCam for Level 1 or Level 2 gas is selected, a gas alarm signals the Vertex M System to store a picture of the stain the next time it advances the Chemcassette® tape. When the tape advances, the tape stops with the stain under the camera, the ChemCam takes a picture and then advance continues. The ChemCam field of view is only wide enough to capture four points on one picture. See [Section 4.5.3 Optional ChemCam](#) for additional information on ChemCam features and functions.

Note:

This activity will consume additional tape. Some faint stains may not be visible via the camera

3.6.4 Configure Point

The Configure Point window provides the following options for each point:

- Select the specific target gas
- Designate the location of the target gas
- Set alarm levels
- Enable/disable point
- Configure concentration logging
- Configure point-specific event help
- Set PLC full-scale concentration

When all of the entries are correct for the point, use either the point selection buttons or choose Next Point/Last Point to scroll to the next point in the analyzer. Press Done when all settings are entered.

Gas Calibration

Select the target gas from the dropdown list. Only the gases valid for the family of gases chosen for the designated tape will appear.

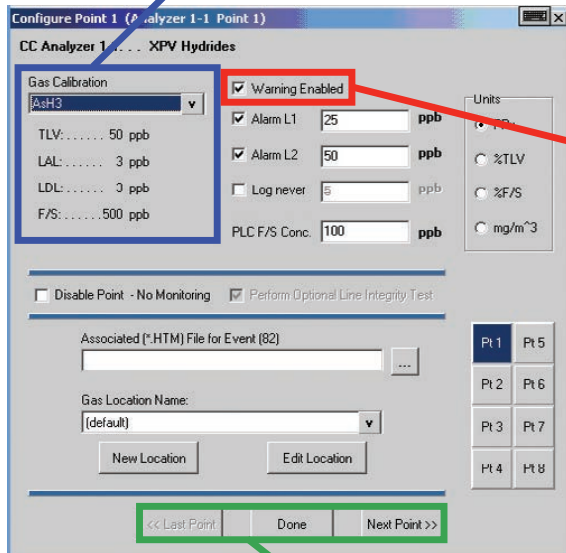

Warning

Select Warning to create an alarm when a gas concentration exceeds the Lower Detection Limit (LDL). See [Appendix A Detectable Gases](#) for a complete list of LDLs. Warnings appear as a “W” on the main screen with no relay actions.

Last Point / Done / Next Point Buttons

Alarm Level 1 and Alarm Level 2

Vertex M loads default alarm levels when you choose a target gas. See [Appendix A Detectable Gases](#) for a list of default alarm levels. You may enter new levels only within the range of the Vertex M detection system.

Make the gas assignments before changing alarm levels. Changing the gas automatically resets alarm level settings to the factory defaults.

The Vertex M System will not allow you to make invalid or inappropriate entries while setting alarm levels. Following are three examples of invalid attempts the Vertex M System will reject:

- The alarm setting for Alarm Level 1 is greater than the setting for Alarm Level 2
- An alarm setting is less than the lowest alarm level for that target gas
- An alarm setting is greater than the full scale for that target gas

Alarm Level 1
Alarm Level 2

Configure Point 1 (Analyzer 1-1 Point 1)

CC Analyzer 1-1... XPV Hydrides

Gas Calibration
AsH3

TLV: 50 ppb
LAL: 2 ppb
LDL: 0 ppb
F/S: 500 ppb

Warning Enabled

Alarm L1 25 ppb

Alarm L2 50 ppb

Log never 5 ppb

PLC F/S Conc: 100 ppb

Units
 PPx
 %TLV
 %F/S
 mg/m³

Disable Point - No Monitoring Perform Optional Line Integrity Test

Associated (*.HTM) File for Event (82)

Gas Location Name:
[default]

New Location Edit Location

<< Last Point Done Next Point >>

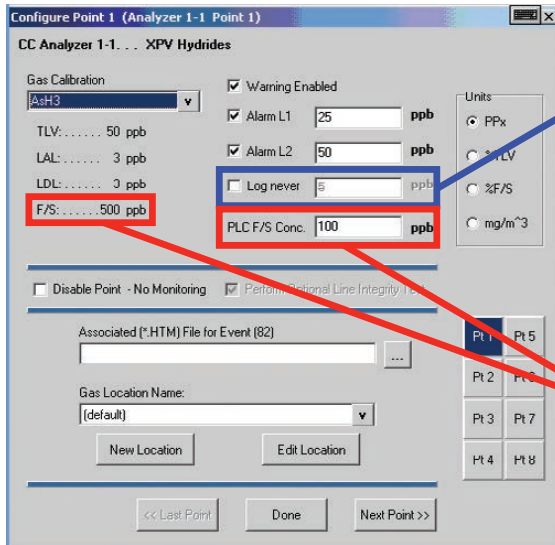

Log never/Log always/Log if
This option sets the frequency that Vertex M enters data into the data log.

PLC F/S Conc. (Data Output)
Calibrates the Vertex M current loop output or data concentration bits to correlate to the customer-specified output range (i.e.; milliamp output scaling or data output scaling to external PLC). Factory default value sets the 20 mA point to two times the TLV which is typically lower than the full scale value of the gas calibration (i.e.; F/S)

	Log Always	Log if >=	Log Never
If concentration is below configured threshold	logs at slow rate	not logged	not logged
If concentration is equal to or greater than configured threshold	logs at fast rate	logs at fast rate	not logged

Note:

Setting the Vertex M System to continuously log concentration data on a 3-analyzer system requires approximately 15 megabytes of disk storage per day. Purge data often to avoid filling available disk space.

Units

Selects the unit of measure to display target gas concentrations. This selection applies to this screen only and does not effect displays during normal operation or events.

Unit choices are:

PPx

Parts-per-million or parts-ber-billion. See [Appendix A Detectable Gases](#) for definition.

%TLV

Displays target gas as a percentage of the threshold limit value. See [Appendix A Detectable Gases](#) for a list of the TLV for each target gas.

%F/S

Displays target gas concentration as a percentage of the full-scale concentration. See [Appendix A Detectable Gases](#) for a list of the full scale concentration for each target gas.

mg/m³

Displays gas concentration in milligrams per cubic meter.

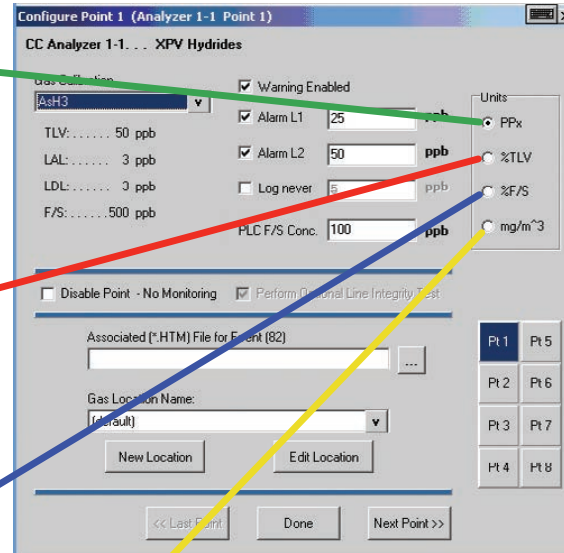

Perform Optional Line Integrity Test

Check this box to perform a sample line integrity test.
See [Appendix A Line Integrity Test Option](#).

**Disable Point
No Monitoring**
Select “Disable Point”
for points not needed.

Associated (*.HTM) File
You may link a user-generated HTML file
to this point. Either type in the file name
or touch the browse (...) button to bring
up a file selection window.

Gas Locations
Use this field to label the location the
point is monitoring. You may assign a
name by one of three methods:

- * Choose a name from the location list.
See “Define Gas Location” for entering
names in the list.
- * Edit the selected location.
- * Create a new location.

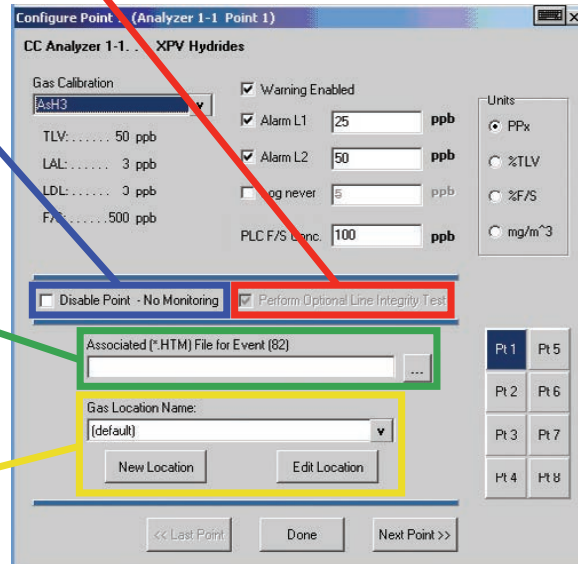

Generate Window Zero Reset Faults

Window Zero Reset events are generated when unusual optics readings occur. Usually these are one-time events and present no long term issues. By default, these events generate an informational event. However, these events can sometimes indicate conditions that could lead to a false concentration readings. For that reason, this option is provided. If selected, a maintenance fault will be generated when a Window Zero Reset event occurs.

Generate Accelerated CC Usage Faults

If a low background level of gas is present that is below the lower detectable limit, a stain can develop on the tape while the Vertex reports zero concentration. This can cause the Chem-cassette to be used up faster than expected. If the option is enabled, a maintenance fault will be generated if this condition exists.

PLC Network

Use to set communication parameters for the optional PLC Network interface.

[F.8 DF1 Interface \(P/N1295-0343\)](#)

[F.9 Modbus Plus Interface \(P/N1295-0330\)](#)

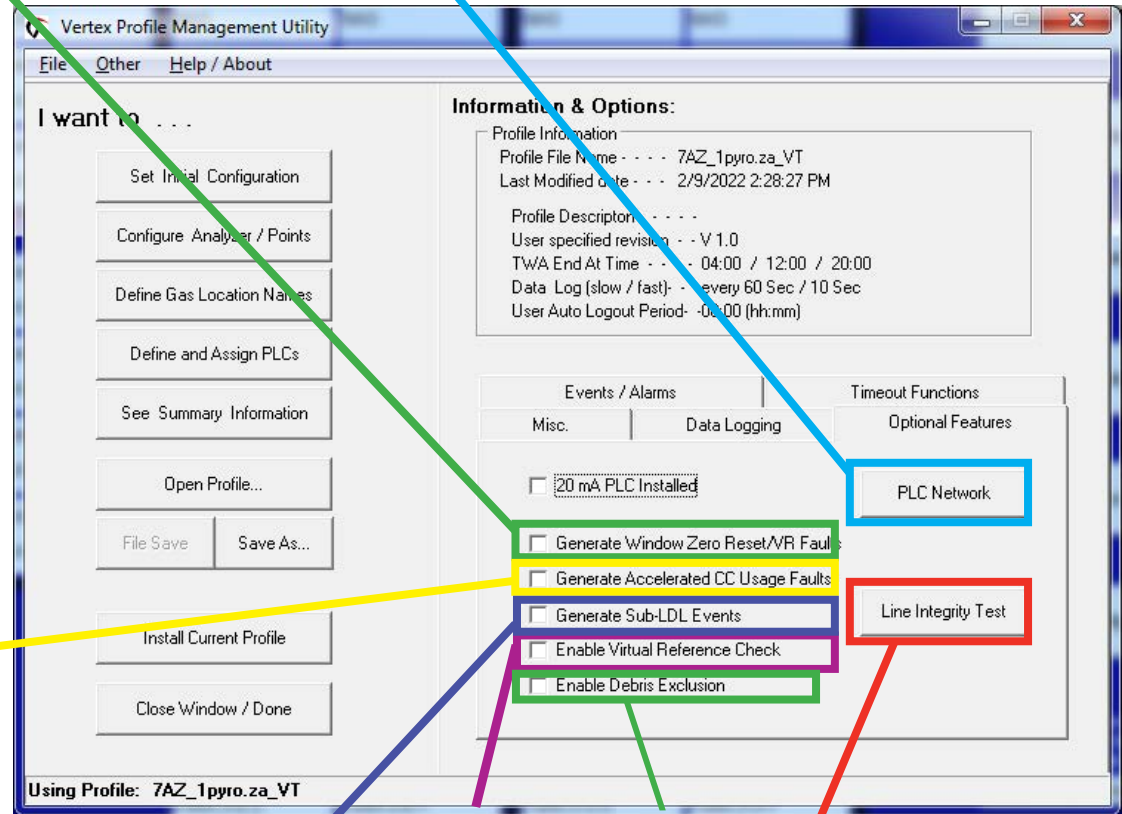

Generate Sub-LDL Events Generates a warning alarm with 0 ppb/ppm concentration that may indicate the presence of gas below LDL.

Virtual Reference Function See the following page.

Enables Debris Exclusion Enables debris exclusion for CLO blocks.

Line Integrity Test Displays the optional Line Integrity Test configuration utility. See [Appendix H - Line Integrity Option](#).

Virtual Reference Function

The Virtual Reference option reduces the possibility that a non-gas event will result in a concentration or alarm. When enabled, it maintains a record of specific monitor operation and, in the event of a reading $\frac{1}{4}$ TLV or above, executes a confirmation before the concentration or alarm is issued. Once confirmed, measurements for the same event will not be affected. See software 1.25.5 release technote for further information.

The Virtual Reference function is user configurable by rack (it is disabled by default). See the following table for the number of windows used and the time to confirm an event. The function reduces the possibility that a non-gas event will result in a concentration or alarm.

Note:

The Virtual Reference function is not used on CLO analyzers, even if enabled.

Chemcassette	Number of Windows Pulled	Time to confirm (sec)
Hydrides	3	15-25
XP Hydrides	3	15-25
Mineral Acids	6	30-40
Cl2/Oxidizers (NO2)	6	30-40
Mineral Acids (Pyro)	6	30-40
Phosgene	6	30-40
XP Phosgene	6	30-40
Aliphatic Amines	3	15-25
Cl2/Oxidizers-III	6	30-40
Hydrogen Cyanide	3	15-25
Hydrogen Sulfide	3	15-25
XPVChlorine	6	30-40
XPV Chlorine-II	3	15-25
Fluorine/Oxidizers	3	15-25
XP Ammonia	3	15-25
XP Mineral Acids	6	30-40
XPVMineral Acids (Pyro)	6	30-40
LL Sulfur Dioxide	3	15-25
XP4 Hydrides	3	15-25
XP4 Mineral Acids	6	30-40
XP4 Mineral Acids (Pyro)	6	30-40
XP4 Chlorine	6	30-40
XP4 Ammonia	3	15-25
XP4 Phosgene	6	30-40

3.6.5 Define and Assign Relays

The Vertex M System includes multiple programmable relays. You may associate relays with one or more alarms or faults to trigger external alarm devices or emergency equipment. Relays are located on relay cards; either 8 or 16 relays populate each card.

Note:

Relays are NOT factory configured.

Vertex M uses a two-part display to configure relays. The Configure PLC window displays the available relay cards and contacts. In a second window, Vertex M also displays a representation of the analyzers installed in the system.

See [Appendix A Optional Relay Specifications](#) for a complete listing of alarm relay specifications.

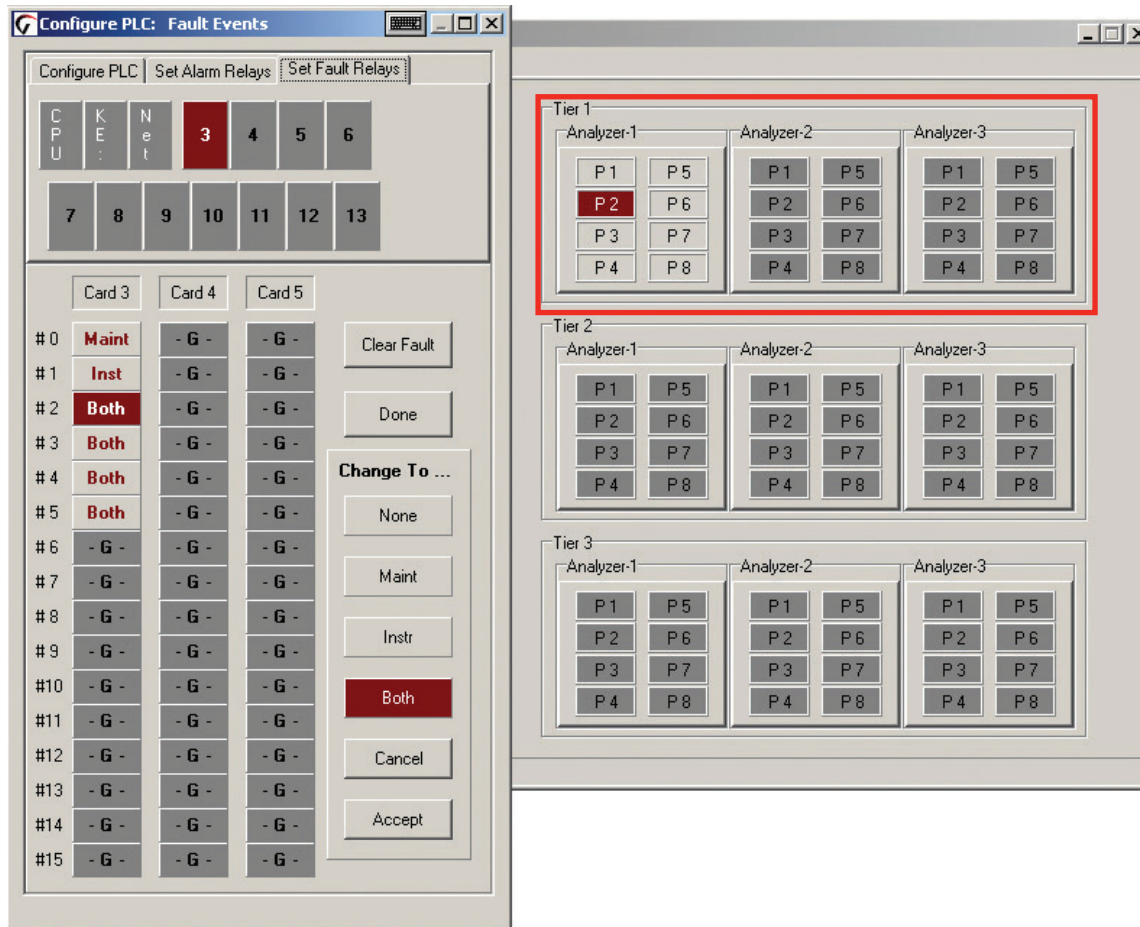

3.6.6 Configure PLC

Use Configure PLC to enter the following:

- The number of relay cards installed
- The number of contacts per card
- The number of relays designated as fault relays.

PLC Relay Cards

Up to 4 relay cards populate the Vertex M System. The cards are numbered 3-6.

Relays per Card

Relays are located on relay cards; either 8 or 16 relays populate each card.

- Cards with 16 relays share a common connection among groups of eight contacts.
- Cards with 8 relays have 8 isolated pairs of contacts.

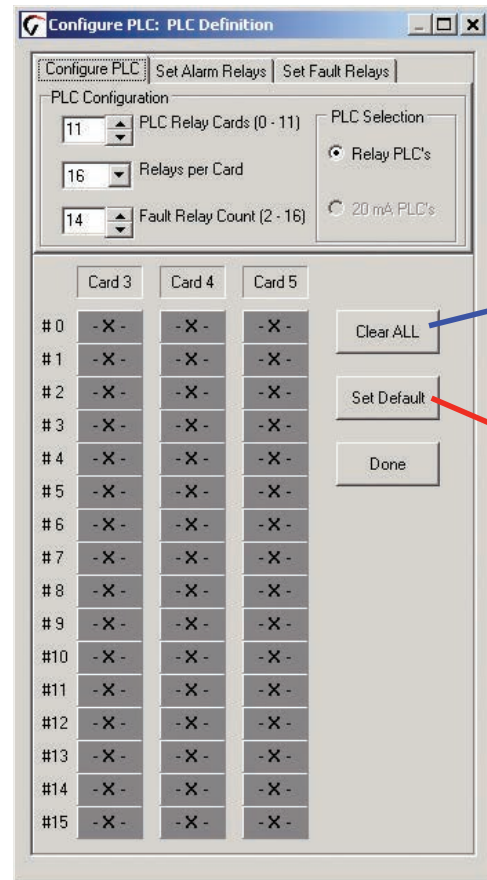

Clear All

Erases the alarm and fault relay definitions

Set Default

Sets all relays to the initial default mappings

Fault Relay Count

You may allocate from 2 to 16 relays for fault indicators.

Note:

Set the number of fault relays before setting alarm relay definitions. If you change the number of fault relays, the current relay definitions become invalid and must be redefined.

When you change the number of fault relays, Vertex M opens the Fault Relay Definition Change dialog box. Choosing Yes shifts the alarm definitions, choosing No pads the alarm definitions. Choose Cancel to return

to the PLC configuration without changing the relay assignments.

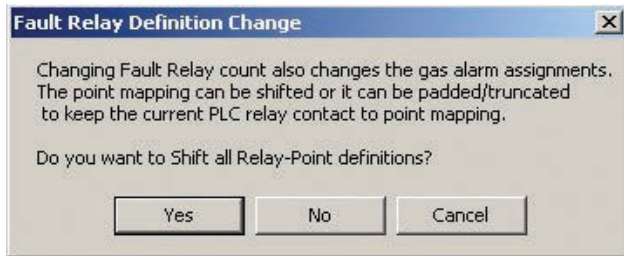

Shift

Alarm relay definitions move down to fill the space created by fewer fault relays or move up to accommodate the additional fault relays.

Changing the number of fault relays from 14 to 16 will cause the alarm relay assignments to move two relays up. Card 5, relay 2 definition moves to card 5, relay 4; card 5, relay 3 moves to card 5 relay 5; card 5 relay 15 moves to card 6, relay 1, etc.

Changing the number of fault relays from 16 to 14 moves relay assignment down by 2 positions. Card 5, relay 4 definition moves to card 5, relay 2; card 5, relay 5 moves to card 5 relay 3; card 6, relay 1 moves to card 5, relay 15, etc.

Pad

Padding leaves most alarm relay definitions unchanged. Some existing alarm definitions may be overwritten or undefined relays may become available.

Changing the number of fault relays from 14 to 16 will cause the alarm definitions on card 3, relay 14 and card 3, relay 15 to be overwritten by the fault relay assignments.

Changing the number of fault relays from 14 to 12 will result in two additional (and undefined) alarm relays being available at card 3 relays 12 and 13. Existing relay definitions are not moved.

3.6.7 Set Alarm Relays

A relay configured for a Level 1 trigger will activate for both Level 1 and Level 2 alarms. A Level 2 trigger will only activate for Level 2 alarms.

None of the relays are defined as general or point specific alarms until they are programmed or associated with one or more points in an analyzer.

Note:

Set the number of fault relays before setting alarm relay definitions. If you change the number of fault relays, the current alarm relay definitions may change and must be redefined. See [Section 3.6.6 Configure PLC](#).

Defining a point for association with a relay is a four-step process:

1. Choose the relays to which you want to associate with a point.
2. Choose L1 Alarm or L2 in the Change To... area.
3. Click the square representing the point or points to associate with the relay. The point changes color to indicate the change.
4. Choose Accept make the change the change to the configuration profile. Choosing cancel leaves the alarm definition unchanged.

Repeat the steps for all contacts.

To verify a contacts association to analyzer points, choose the contact. The associated point display changes color.

Clear all alarm definitions from relays

Squares that represent the point or points to associate with the relay

Configure PLC: Gas Events

Configure PLC | Set Alarm Relays | Set Fault Relays

CPU	KE	Net	3	4	5	6
7	8	9	10	11	12	13

	(3)	(4)	(5)
# 0	Maint	- G -	- G -
# 1	Inst	- G -	- G -
# 2	Both	- G -	- G -
# 3	Both	- G -	- G -
# 4	Both	- G -	- G -
# 5	Both	- G -	- G -
# 6	- G -	- G -	- G -
# 7	- G -	- G -	- G -
# 8	- G -	- G -	- G -
# 9	- G -	- G -	- G -
# 10	- G -	- G -	- G -
# 11	- G -	- G -	- G -
# 12	- G -	- G -	- G -
# 13	- G -	- G -	- G -
# 14	- G -	- G -	- G -
# 15	- G -	- G -	- G -

Clear Alarm

Done

Change To ...

None

L1 Alarm

L2 Alarm

Cancel

Accept

Tier 1

Analyzer-1	Analyzer-2	Analyzer-3
P1 P5	P1 P5	P1 P5
P2 P6	P2 P6	P2 P6
P3 P7	P3 P7	P3 P7
P4 P8	P4 P8	P4 P8

Tier 2

Analyzer-1	Analyzer-2	Analyzer-3
P1 P5	P1 P5	P1 P5
P2 P6	P2 P6	P2 P6
P3 P7	P3 P7	P3 P7
P4 P8	P4 P8	P4 P8

Tier 3

Analyzer-1	Analyzer-2	Analyzer-3
P1 P5	P1 P5	P1 P5
P2 P6	P2 P6	P2 P6
P3 P7	P3 P7	P3 P7
P4 P8	P4 P8	P4 P8

Selected relay in the relay block

Set type of alarm

3.6.8 Set Fault Relays

Fault relay contacts activate for instrument or maintenance faults. Faults are associated with an entire analyzer and not individual points.

- Instrument faults indicate a loss of monitoring on one or more points.
- Maintenance faults indicate the Vertex M System requires attention but is continuing to monitor.

Note:

The number of relays used for fault indication is configurable. See [Section 3.6.6 Configure PLC](#).

Defining an analyzer for association with a relay is a four-step process:

1. Choose the relays to which you want to associate with an analyzer.
2. Choose Instrument, Maintenance, Both or None in the Change To... area.
3. Click the square representing the analyzer or analyzers to associate with the relay. The square changes color to indicate the association.
4. Choose Accept to modify to the configuration profile. Choosing Cancel leaves the alarm definition unchanged.

Repeat for all relays.

To verify a relay's assignment to analyzers, choose the contact. The associated analyzer changes color.

Clears all fault definitions from all relays

Square that represents the analyzer or analyzers to associate with the relay

Selected relay in the relay block

Set type of fault

Relay #	Card 3	Card 4	Card 5
#0	Both	- G -	- G -
#1	Both	- G -	- G -
#2	Both	- G -	- G -
#3	Both	- G -	- G -
#4	Both	- G -	- G -
#5	Both	- G -	- G -
#6	Both	- G -	- G -
#7	Both	- G -	- G -
#8	Both	- G -	- G -
#9	none	- G -	- G -
#10	none	- G -	- G -
#11	none	- G -	- G -
#12	none	- G -	- G -
#13	none	- G -	- G -
#14	- G -	- G -	- G -
#15	- G -	- G -	- G -

Change To ...

- None
- Maint
- Instr
- Both
- Cancel
- Accept

3.6.9 Profile Management-File Menu

Use the file menu to open, create, save or close a configuration file. Configuration files may be stored in any directory on the Vertex M System hard disk.

When you make any changes to the configuration profile, Vertex M will always prompt you to save the change before closing the Configuration window.

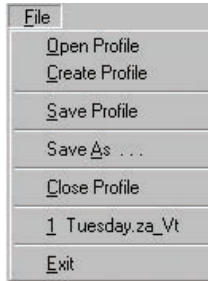

3.6.10 Other Menu

The Other Menu offers several shortcuts to speed configuring the Vertex M System.

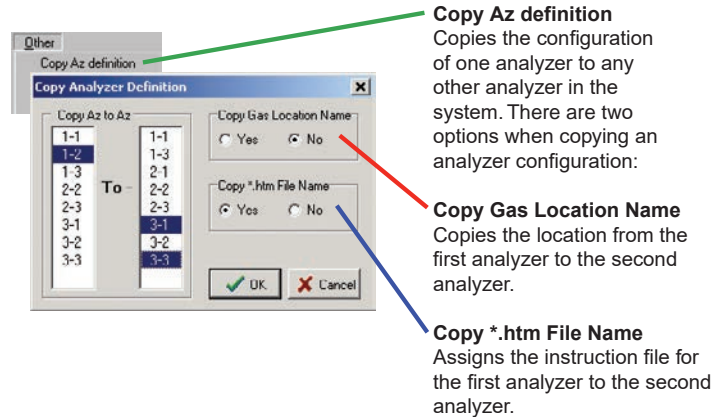

Copy Az definition
Copies the configuration of one analyzer to any other analyzer in the system. There are two options when copying an analyzer configuration:

Copy Gas Location Name
Copies the location from the first analyzer to the second analyzer.

Copy *.htm File Name
Assigns the instruction file for the first analyzer to the second analyzer.

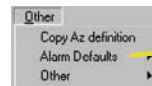

Alarm Defaults
Sets the level 1 and level 2 alarms of all analyzers not yet configured to the following values:

- * One-half TLV and TLV
- * TLV and two times TLV
- * One-half TLV and two times TLV

3.7 Load Tape

After configuring the analyzers, load each analyzer with the proper Chemcassette® tape required for the target gas. See [Section 5.3.4 Change Chemcassette® Tape](#) for loading procedure. See Detectable Gases, for a list of target gases and Chemcassette® tape part numbers.

After installing Chemcassettes® for initial configuration, keep the analyzer in IDLE mode. Do not move to monitor mode until you have:

Performed a leak check on sample lines. See [Section 3.8 Leak Checking Sample Lines](#).

Verified flow rates See [Section 3.9.1 Verify Flow Rates](#).

3.8 Verify Flow Rates and Supply Vacuum

After you have configured all analyzers, loaded Chemcassettes® and performed leak check, you will verify flow rates in the Flow Diagnostics Window. From Main Screen, touch Menu, Service, Authorized Service. The Authorized Service window opens.

Note:

At higher altitudes with many analyzers installed, the system (50 Hz. mains) may not be able to achieve 13" Hg.

3.8.1 Verify Flow Rates

The Authorized Service window displays the flow range in bar graph form for each point of the selected analyzer.

Choose the analyzer from the selection pad in the upper right-hand corner. Press the pump on button. The eight points display their flow.

Vertex M™ 24-Point Continuous Monitor

Selection Pad

Flow (cc/min)
The real-time sample flow to the point.

Point Vacuum (in Hg)
Point Vacuum indicates the restriction from sample line length and the pressure developed by shared lines.

Supply Vacuum
Typical supply vacuum is 9-12 in. Hg

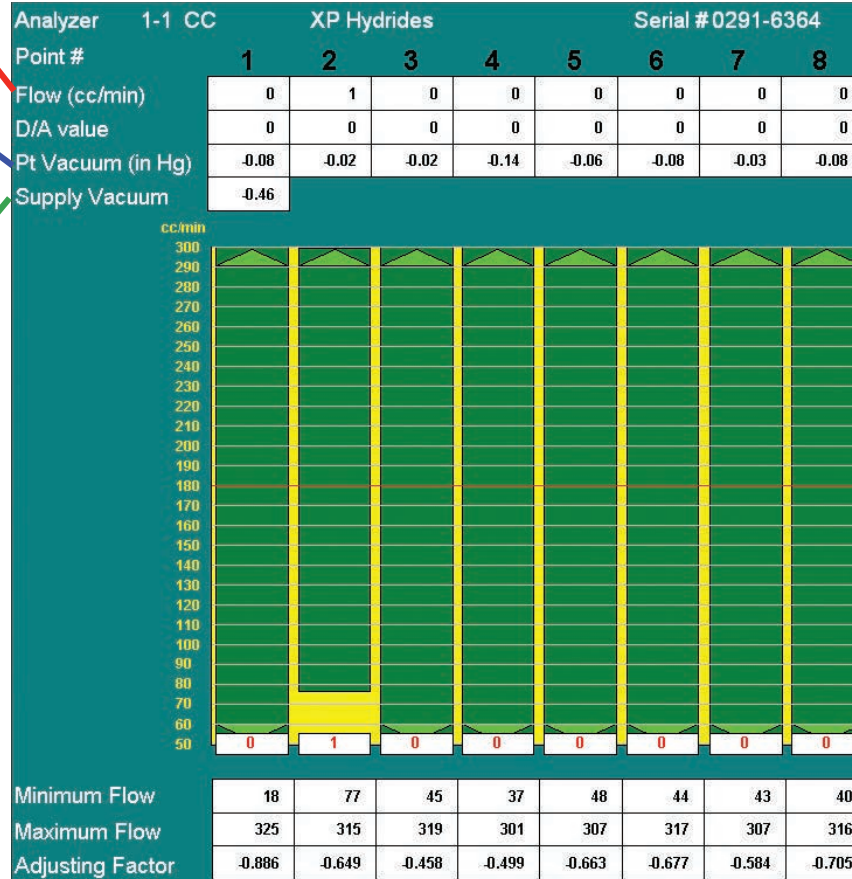

Pump 1 Pump 2 February 26, 2009
03:03:46 PM

Pump 1 Pump 2
GOOD GOOD
OFF OFF

Pump 1 Pump 2

1-1 IDLE	1-2 IDLE	N/A
N/A	N/A	N/A
N/A	N/A	N/A

Pump On

Pump Off

Auto Balance Record Known Good LTC Pump Alternate

Line Integrity Test Main Screen Help

Optional Line Integrity Test Option
See [Appendix A Line Integrity Test Option](#)

Target Flow

A horizontal red line indicates the target flow rate required by the Vertex M System for correct analysis. The target flow rate is 180 cc/min. +/-5% (171-189 cc/min.)

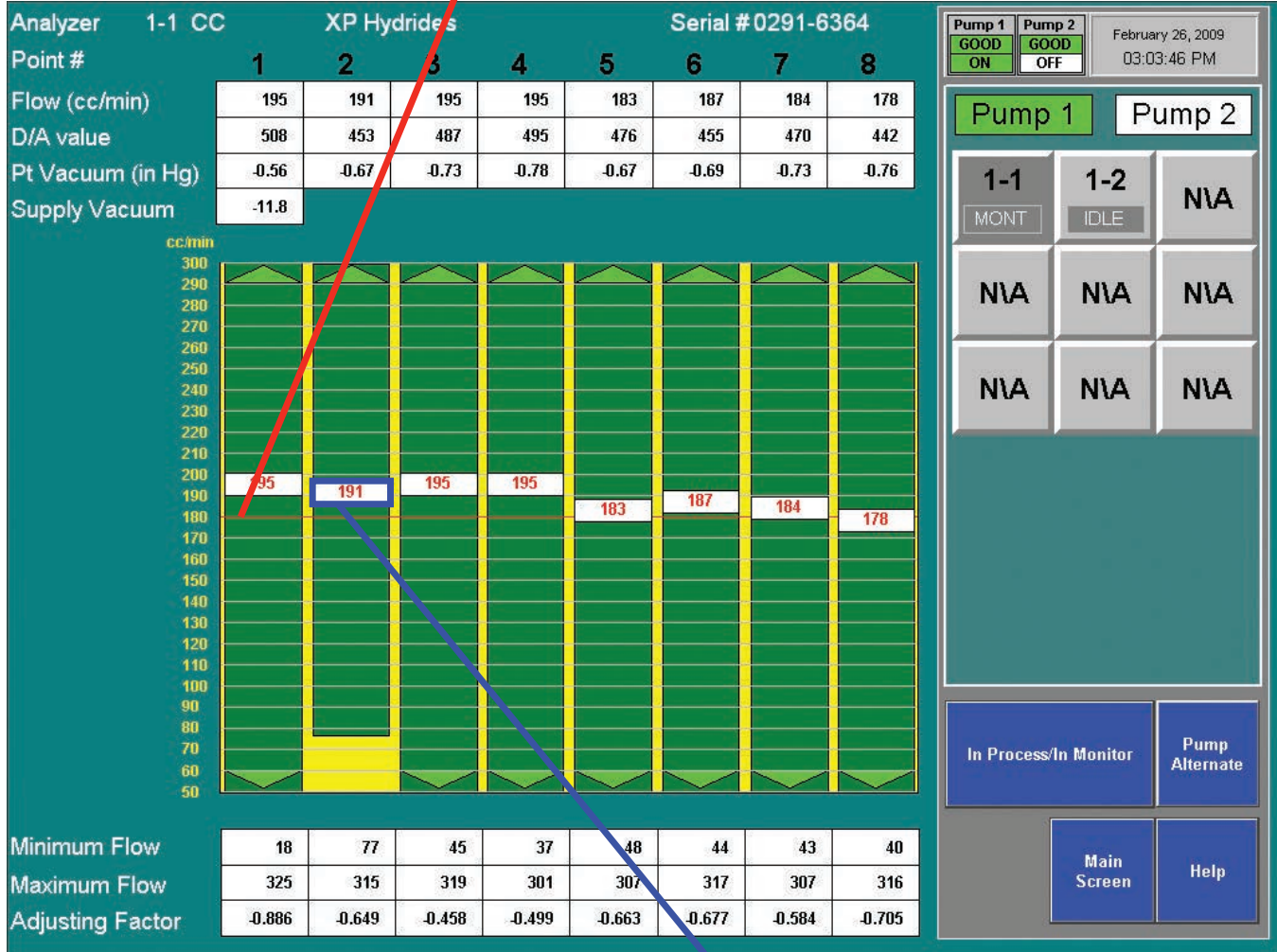

Flow Rate

A floating white box indicates the actual flow rate. The position of the box graphs the flow; the numerical value of the flow is displayed in the box.

Vertex M™ 24-Point Continuous Monitor

Minimum Flow

The minimum flow possible with the attached sample line and orifice.

Proportional Value Range

A vertical green bar displays the dynamic range over which the proportional valve can adjust the flow rate. Indicated numerically by Minimum Flow and Maximum Flow.

Analyzer 1-1 CC
Point #
Flow (cc/min)
D/A value
Pt Vacuum (in Hg)
Supply Vacuum

XP Hydrides

	1	2	3	4	5	6	7	8
Flow (cc/min)	0	1	0	0	0	0	0	0
D/A value	0	0	0	0	0	0	0	0
Pt Vacuum (in Hg)	-0.08	-0.02	-0.02	-0.14	-0.06	-0.08	-0.03	-0.08
Supply Vacuum	-0.46							

Serial #0291-6364

Pump 1 **GOOD** OFF
Pump 2 **GOOD** OFF

February 26, 2009
03:03:46 PM

Pump 1 Pump 2

1-1 IDLE	1-2 IDLE	N/A
N/A	N/A	N/A
N/A	N/A	N/A

Pump On

Pump Off

Auto Balance	Record Known Good LITC	Pump Alternate
Line Integrity Test	Main Screen	Help

Minimum Flow	18	77	45	37	48	44	43	40
Maximum Flow	325	315	319	301	307	317	307	316
Adjusting Factor	-0.886	-0.649	-0.458	-0.499	-0.663	-0.677	-0.584	-0.705

Maximum Flow

The maximum flow possible with the attached sample line and orifice.

Auto Balance

See [Section 4.6.2 Flow Calibration](#) for instructions on adjusting flow rates.

3.9 Leak Checking Sample Lines

Perform a leak check of the sample lines following installation and also whenever a line is changed or moved. The leak check procedure involves plugging the end of the sample line and verifying that there is no flow through the line. To perform a leak check:

1. Put the affected Analyzer in Idle mode.
2. Choose Main Screen, Menu, Service, Authorized Service.
3. Select Analyzer.
4. Press pump on.
5. Securely plug the end of the sample line being tested.
6. Verify that the flow rate for the test line drops to zero. See Flow (cc/min) on page 3-36.
7. Verify that the sample Point Vacuum equals the Supply Vacuum within a tolerance of +/-0.5 inches Hg (see Point Vacuum (in Hg)) on page 3-36.
8. “Verify that the sample flow is less than 20cc.” “See Flow (cc/min)” and “(see Point Vacuum (in Hg)) are links.
9. After testing all points on the selected analyzer, press Pump Off.

Note:

You must touch the Pumps On button even if the pumps are operating. Touching Pumps On turns on the solenoid valve to provide vacuum to the analyzer.

A sample point failing to meet both the flow and vacuum conditions of step 7 indicates either a leak in the sample line or a faulty sample inlet connection.

To troubleshoot the condition, disconnect the sample line at the inlet port at the top of the Vertex M cabinet. Securely plug the inlet port and repeat the above leak check procedure.

If the sample point passes the test with the top port plugged, the leak is somewhere in the sample line and the line must be replaced. If the sample point fails the leak check procedure with the top inlet port plugged, contact Honeywell Analytics for assistance.

3.10 Reconfigure

The modular design of the Vertex M allows limited reconfiguration. All wiring and tubing is in place behind unpopulated slots. To add modules:

1. Remove filler panel.
2. Install new analyzer. See [Section 5.4 Replacing an Analyzer](#).
3. Configure new analyzer. See [Section 3.6 Configuration Utility](#).
4. Load tape. See [Section 3.7 Load Tape](#).
5. Leak check sample lines. See [Section 3.9 Leak Checking Sample Lines](#).
6. Verify flow rates. See [Section 3.8 Verify Flow Rates and Supply Vacuum](#).

Note:

Any analyzers which are physically installed but not included in the configuration should be de-energized.

3.11 Moving to a New Site

Before moving the Vertex M to a new site, use the following procedures to prevent loss of data or damage to the monitor.

1. Remove all Chemcassette® tapes and store as required by local policies.
2. Exit the Vertex M program. Touch Project and then Stop Project.
3. Back up data and configuration files. See [Section 5.10 File Maintenance](#).
4. Open the front door and set all power switches to “Off”.
5. Disconnect electrical supply at the source and then disconnect from the power terminal in the side of the cabinet.
6. Disconnect sample lines and cap lines as required by local policies also cap Vertex M inlet points.
7. Disconnect exhaust line and cap line as required by local policies.
8. Disconnect alarm relays.



CAUTION

Leaks in the exhaust tubing connection can cause exposure to toxic gases from remote sample areas. For leak-tight connections, follow the instructions in the *Installing Pump Exhaust Line* section and the *Remove Pump* section. With the system running, verify the leak integrity with a small amount of leak test fluid.



WARNING

Hazardous voltages may exist at the Alarm Contacts in this unit with the power switch turned off. Insure power is disconnected at the source prior to servicing alarm contacts.

Crate and pad the Vertex M to prevent damage during transport. If unsure of packing requirements, contact the Honeywell Analytics Service department.

System Shutdown

CAUTION

Failure to properly shut down the Vertex M could result in system file corruption.

1. Exit the Vertex program. Touch Project and then Stop Project.
2. In the Windows taskbar touch Start and then Shut Down.
3. Open touch screen and set all switches and the rack power switch to “Off”.

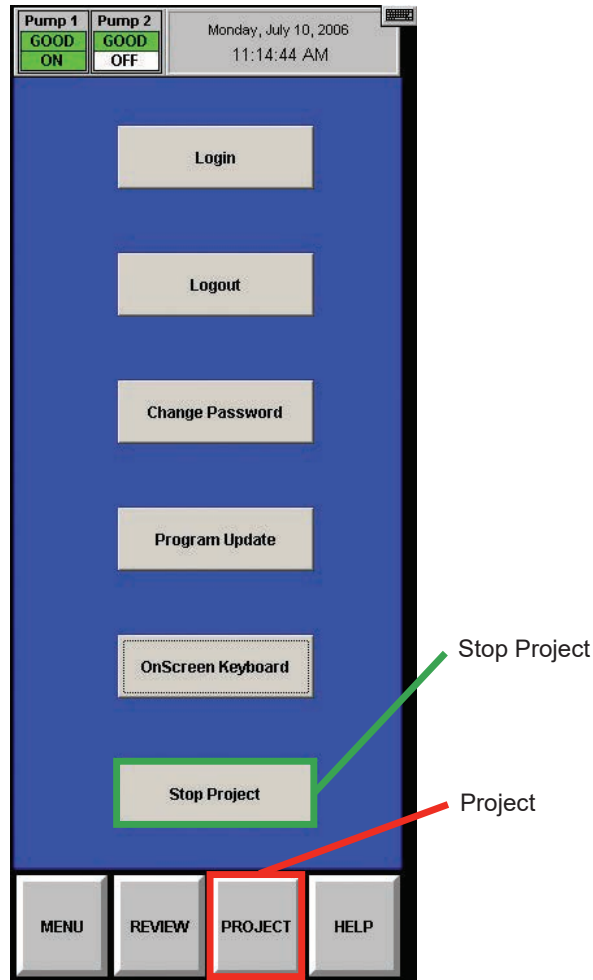

4 Operation

4.1 Introduction

This chapter describes Vertex M operation including monitoring, system control and data viewing.

This chapter includes the following sections:

- [4.2 Monitoring Mode Overview](#)
- [4.3 Main Screen](#)
- [4.4 Project Functions](#)
- [4.5 Review Functions](#)
- [4.6 Menu Buttons](#)
- [4.7 OnScreen Keyboard](#)

See [Section 3 Startup](#) if the analyzers in the Vertex M System have not yet been configured.

4.2 Monitoring Mode Overview

Monitor mode is the Vertex M System's standard operating state. Upon power up, the monitor performs initialization routines and returns to the same state as when powered down. During monitoring, the Vertex M System will calculate concentrations every second for each of the enabled points. Concentrations are used for:

- Triggering alarm relays
- Viewing in the main screen
- Entries in the event list
- Viewing in point detail screen

Concentration information is available through the:

- Point detail screen
- OPC
- Optional fieldbuses
- Optional 4-20 mA output
- Data logger

4.3 Main Screen

The Vertex M System opens the main screen after power up. Vertex M divides the main screen into three areas:

- System display
- Point detail
- Function buttons

MONT	1-1 CC	MONT	1-2 CC	IDLE	1-3 CC
First three AsH3	Point 1-1-5 AsH3	Point 1-2-1 NH3	Point 1-2-5 NH3	Point 1-3-1 AsH3	Point 1-3-5 AsH3
First three AsH3	Point 1-1-6 AsH3	Point 1-2-2 NH3	Point 1-2-6 NH3	Point 1-3-2 AsH3	Point 1-3-6 AsH3
First three AsH3	Point 1-1-7 AsH3	Point 1-2-3 NH3	Point 1-2-7 NH3	Point 1-3-3 AsH3	Point 1-3-7 AsH3
Point 1-1-4 AsH3	Point 1-1-8 AsH3	Point 1-2-4 NH3	Point 1-2-8 NH3	Point 1-3-4 AsH3	Point 1-3-8 AsH3

Pump 1: GOOD ON | Pump 2: GOOD OFF | Wednesday, June 10, 2009 8:32:11 AM

Config File: Mike1.za_VT
 USER ID: DEFAULT
 Location: Point 1-3-3
 Analyzer: CC
 Tier-Slot-Pt: 1-3-3
 Point: Enabled
 Alarm RT: Enabled
 Alarm Cfg: Enabled

Gas	Conc	Alarm
AsH3	0.000 ppb	

Point Color Legend:

- Normal
- Alarm
- Runtime Alarm Disabled
- Configuration Alarm Disable
- Runtime Point Disable
- Configuration Point Disable

Event History	Data Trend	Point Details	Event List
---------------	------------	---------------	------------

MENU	REVIEW	PROJECT	HELP
------	--------	---------	------

System Display

Function Buttons

Point Detail

4.3.1 System Display Area

The System Display Area displays information about all of the points in the Vertex System. Each of the 72 blocks in the System Display Area represents one point. A group of eight blocks represents an analyzer block. The analyzer block has the status bar indicator at the top of the block. A pyrolyzer displays as a blue block in slot 1 and points detail in slot 2.

The System Display Area positions the modules in the same order in which they are physically located in monitor. The currently selected point displays a green border. If more than one point has the same gas location as the selected point, all points in same location display with green border.

Universal
Chemcassette
Analyzer

The screenshot shows the System Display interface. It features a grid of 72 point blocks arranged in 3 columns and 24 rows. The top row of each column is a header row. The first column is labeled '1-1 CC', the second '1-2 CC', and the third '1-3 CC'. The first three rows of each column are labeled 'First three AsH3'. The remaining 21 rows are labeled 'Point 1-1-4 AsH3' through 'Point 1-3-8 AsH3'. A green border highlights the 'Point 1-3-3 AsH3' block. To the right of the grid is a configuration panel for 'Pump 1' and 'Pump 2', both showing 'GOOD' status. Below this is a 'Config File' section with details for 'Mike1.za_VT'. At the bottom right is a 'Point Color Legend' with color-coded boxes for Normal, Alarm, Runtime, Alarm Disabled, Configuration, Alarm Disable, Runtime Point Disable, and Configuration Point Disable. Below the legend are four buttons: 'Event History', 'Data Trend', 'Point Details', and 'Event List'. At the very bottom are four buttons: 'MENU', 'REVIEW', 'PROJECT', and 'HELP'.

System Display

Status Indicators

The indicator displays brief information about analyzer status such as faults, warnings or maintenance functions in process.

	IDLE 1-2 CC	
Point 1	Point 1-2-1 HF	Point 1-2-5 HF
Point 2	Point 1-2-2 HF	Point 1-2-6 HF
Point 3	Point 1-2-3 HF	Point 1-2-7 HF
Point 4	Point 1-2-4 HF	Point 1-2-8 HF
		Point 5
		Point 6
		Point 7
		Point 8

Status indicators include:

- IDLE - the analyzer is not monitoring or performing maintenance
- MONT - the analyzer is monitoring
- LD CC - Load Chemcassette® routine is in progress
- PROG - a new application program is being loaded into the analyzer
- CONF - a new configuration is being loaded into the analyzer
- COMF - a communications failure between the DAq and the analyzer
- PYRO-W - a pyrolyzer analyzer is warming up. When pyrolyzer has reached stable temperature, it will automatically go into monitor
- FLOW - a flow Auto Balance procedure is in process on the analyzer

The Vertex System displays only the short names of the location and target gases within each point block. During normal monitoring, the background color of each block is white. Vertex will change the background color of a point as conditions change.

White	Normal operation.
Blue	Alarms for the point are disabled in the runtime options menu.
Grey	Point is disabled in the runtime menu or is disabled due to a fault.
Red	Gas concentration exceeded an alarm level.
Purple	Disable configuration alarm
Black	Point is not configured for monitoring.

Table 4-1.

Alarm Indicators

When the target gas concentration for a point reaches a preset alarm level, Vertex will display a W, 1 or 2 in the point block to indicate the severity of the alarm.

Alarm Indicator	Concentration Threshold
W (if enabled)	Lower Detectable Limit (LDL)
1	Alarm Level 1
2	Alarm Level 2

See [Section 3.6.4 Configure Point](#) for information on setting Alarm Level 1 and Alarm Level 2.

See [Section 3.6.10 Other Menu](#) for information on alarm default values.

Pump Status Indicator

The Vertex Display includes pump status indicators in the top right corner. The bottom row indicates which of the pumps is currently operating. The indicator will display “ON” with a green background if the pump is operating and “OFF” on a white background if the pump is not running.

The top row indicates what is known about pump health. The indicator will display “GOOD” with a green background if the pump has successfully provided proper levels of system vacuum. If the Indicator displays “BAD” on a red background, this indicates that pump related faults 112 or 219 have been generated. The indicator may display “UNKNOWN” on a white background after software is installed or after analyzers are added or moved into a different location.

Pumps in the “UNKNOWN” or “BAD” state change to the “GOOD” state only when successfully used during gas monitoring. After a failed pump has been repaired or replaced, it can be exercised by pressing “PUMP ALTERNATE” button while monitoring. See [Section 4.6.2 Flow Calibration](#). If successful, the pump state will change to “GOOD”.

Honeywell Analytics recommends that pumps be alternated periodically to insure availability according to your facility’s schedule.

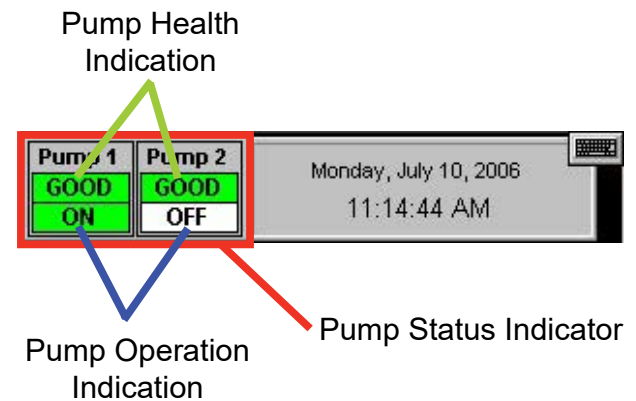

Fault Indicators

In addition to changing color, an event window opens indicating a new event.

A yellow square inside the status bar in the analyzer block indicates an analyzer-specific fault.

A yellow square inside of the point block indicates a point-specific fault.

- See [Section 6.3 Maintenance Faults](#)
- See [Section 6.5 Information Events](#)

MONIT	1-1 CC	M	MONIT	1-2 CC		IDLE	1-3 CC	
First three AsH3	Point 1-1-5 AsH3		Point 1-2-1 NH3	Point 1-2-5 NH3	F	Point 1-3-1 AsH3	Point 1-3-5 AsH3	
First three AsH3	Point 1-1-6 AsH3		Point 1-2-2 NH3	Point 1-2-6 NH3	M	Point 1-3-2 AsH3	Point 1-3-6 AsH3	
First three AsH3	Point 1-1-7 AsH3		Point 1-2-3 NH3	Point 1-2-7 NH3	M	Point 1-3-3 AsH3	Point 1-3-7 AsH3	
Point 1-1-4 AsH3	Point 1-1-8 AsH3		Point 1-2-4 NH3	Point 1-2-8 NH3	F	Point 1-3-4 AsH3	Point 1-3-8 AsH3	

Pump 1	Pump 2	Wednesday, June 10, 2009	
GOOD	GOOD	8:39:41 AM	
ON	OFF	No. Of Events	Display Events
		7	1 - 4
		Point 1-2-7	1-2-7
		101 FLOW ADJ ERR LOW	M
		6/10/09 8:34:28 AM	
		Point 1-2-6	1-2-6
		101 FLOW ADJ ERR LOW	M
		6/10/09 8:34:28 AM	
		Point 1-2-3	1-2-3
		101 FLOW ADJ ERR LOW	M
		6/10/09 8:34:28 AM	
		Point 1-2-2	1-2-2
		101 FLOW ADJ ERR LOW	M
		6/10/09 8:34:27 AM	
More			
Ack Current	Ack All	Reset Current	Reset All
Event History	Data Trend	Point Details	Event Help
MENU	REVIEW	PROJECT	HELP

M - Indicates a maintenance fault

F - Indicates an instrument fault

4.3.2 Point Detail Display Area

The Point Detail Area (see Figure 4-1) displays comprehensive information about each location. Touching a block in the System Display Area displays the current information about a location.

Config File	The configuration profile file name
User ID	The name of the current, logged in user
Location	The short name of the sampled location
Tier-Slot-Point	Points are identified by the tier, slot and their point number in which the analyzer is installed
Point.	Points not needed for monitoring may be disabled. A disabled point does not trigger alarms

- See [Section 4.5.4 Event List](#)
- See [Section 4.5.2 Data Trend](#)
- See [Section 4.5.1 Event History](#)



Figure 4-1.

Figure 4-2 is an image of the Point Detail section of the main Vertex display screen snapshot

Analyzer	The analyzer type
Points / Alarms	A point may be enabled but the alarm may be disabled
Gas Data	Name of the gas or gases, up to three gases per location Current concentration for each gas Alarms, if any, for that point and gas. This field shows “on” or blank.
Point Color Legend	This legend defines the background colors in the system display area

Note:

A Vertex System equipped with two or more analyzer modules can monitor up to three different gases per location. However, you may not program an analyzer for more than one gas family at a time. When you configure the Vertex System for multiple gases per location, touching a point on the system display area will also change the border on other points monitoring the same location. The information for a location displayed in the point detail area will be identical regardless of which point is selected in the system display area.

Pump 1 **Pump 2**
GOOD **BAD**
OFF **OFF**

Friday, September 5, 2008
 8:13:27 AM

Config File: **Andy 9.4.08.za_vt**
 USER ID: **DEFAULT**
 Location: **Point 1-1-1**
 Analyzer: **CC**
 Tier-Slot-Pt: **1-1-1**
 Point: **Enabled**
 Alarm RT: **Enabled**
 Alarm Cfg: **Enabled**

Gas	Conc	Alarm
NH3	12,500 ppm	On

Point Color Legend:

Normal	Alarm
Runtime Alarm Disabled	Configuration Alarm Disable
Runtime Point Disable	Configuration Point Disable

Event History **Data Trend** **Point Details** **Event List**

MENU **REVIEW** **PROJECT** **HELP**

Figure 4-2.

4.3.3 Function Buttons

Use the function buttons located under the point detail area to access the following areas.

Menu - Perform runtime changes, flow calibration, maintenance, diagnostics and service functions, edit security settings and configure the system.

Review - View stored historical gas concentration data or events and access ChemCam.

Project - Log in, log out, change passwords, update programs and stop the project (exit Vertex M).

Help - Opens a window to explain the functions of the main screen.



4.4 Project Functions

Use Project functions to log in, log out, change passwords, update programs, restore the keyboard and stop the project (exit Vertex M).

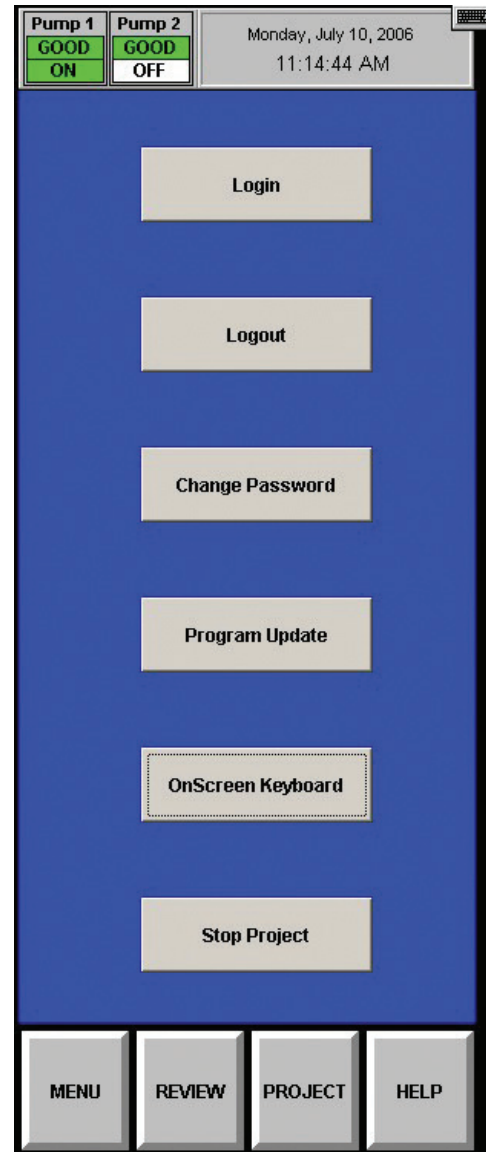

4.4.1 Log In and Log Out

To protect the integrity of the system, the Vertex System classifies menus as either open or protected functions. If you require access to a protected menu, you must log in under a user account with permission to use that menu. The Vertex System administrator assigns access to protected functions by setting up user accounts.

See [Section 4.6.6 Security Access](#) for more information.

Logging In

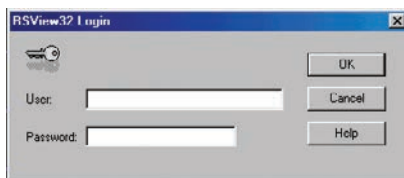

Figure 4-3. Login

To log in, choose Main Screen, Project and then Log In. The Login window opens. Enter your user account name and password followed by Enter.

After you log in, the system checks your access privileges. As you use Vertex menus, only the buttons to which you have access will be active. The buttons associated with functions to which you are denied access are dimmed.

A user can choose Logout to select the default user account.

Logging Out

To log out, choose Main screen, Project and then Logout. A Log Out confirmation window appears. Simply click OK to close the window.

The Vertex System will automatically log out any user after a period of inactivity. The default timeout period is 8 hours. Authorized users may change the timeout setting in the Configuration Menu.

Thirty seconds prior to the end of the timeout period, Vertex will warn before logging out a user.

4.4.2 Changing Password

You may change your password at anytime. To change your password:

1. Login with old password.
2. Touch Project and then Change Password.
3. Enter old password.
4. Enter new password in both text boxes.
5. Touch Enter.

If both new passwords are identical, Vertex will accept your new password.

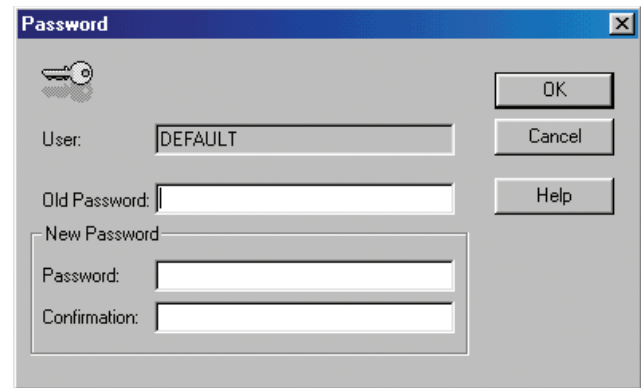

Figure 4-4. Password Change

4.4.3 Updating Program

Contact Honeywell Analytics for details.

4.4.4 Restore OnScreen Keyboard

Use the OnScreen Keyboard button to restore the keyboard if it becomes hidden.

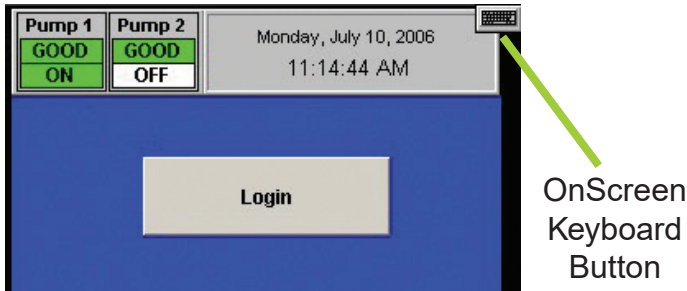

4.4.5 Stopping Project

Use Stop Project to exit the Vertex M program. Touch Project and then Stop Project.

Even though the Vertex M program is not running, individual analyzers continue to monitor and store data in their internal memory.

4.5 Review Functions

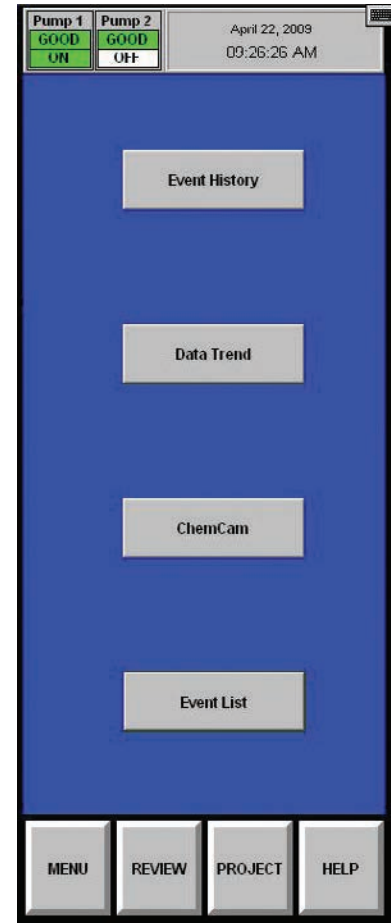

Use Review functions to view information stored in the Vertex M System database. Available for viewing through the Review menu are:

- View currently active events using Event List.
- View historical events using Event History.
- View historical or real time concentration data through the Data Trend window.
- Access ChemCam functionality.

4.5.1 Event History

An event is any action that the Vertex System is required to enter into the database. As events occur, the Vertex System stores the events in a database on the DAq PC. The default database format is Microsoft Access.

Use the Event History Window to sort and filter data in the event log.

Datetime	Event	Module	Point	Gas	Conc/Data	Unit	Message	UserID
9/4/08 1:31:21 PM	MAINT FAULT	Az1-1	1	NH3	-6.67	ppm	114 Excessive Point Vacuum	
9/4/08 1:31:20 PM	INFO	Az1-1	1	NH3	60.26	ppm	Flow Corrected	
9/4/08 1:30:56 PM	TWA	Az1-1	0		0.0		New Time Weighted Average Started	
9/4/08 1:30:54 PM	INFO	Az1-1	0		0.0		Start Monitor	
9/4/08 1:30:50 PM	RUNTIME	Az1-1	0		0.0		Command - Start Monitoring	DEFAULT
9/4/08 1:30:38 PM	RESET FAULT SIMULATE	Az1-1	0		0.0		Simulate Instrument Fault	
9/4/08 1:30:35 PM	USER RESET	Az1-1	0		0.0		Simulate Instrument Fault	DEFAULT
9/4/08 1:29:11 PM	FAULT SIMULATE	Az1-1	0		0.0		Simulate Instrument Fault	
9/4/08 1:29:07 PM	SIM FAULT REQUEST	Az1-1	0		0.0		Command - Require Inst-Fault Simulation	DEFAULT
9/4/08 1:28:59 PM	ALM SIMULATE	Az1-1	1	NH3	12.5	ppm	Simulate ALM	
9/4/08 1:28:56 PM	SIM-ALM REQUEST	Az1-1	1		0.0		Command - Require Alarm 1 Simulation	DEFAULT
9/4/08 1:28:48 PM	TWA	Az1-1	7	NH3	0.0	ppm	Time Weighted Average	

Filter Options: Start Options: On Date: [] Module: All Logging Station: All Date Range: From: 8/22/2008 To: 9/5/2008 Max Records: 500 Event: All Total: 500 << >> PageUp PageDown Apply/Refresh Display All More Fields Print Save

Figure 4-5. Event History

Events include but are not limited to:

- Alarms and faults
- User log in and log outs
- Configuration changes
- System maintenance
- Security changes
- Time and date of power up
- User comments

The peak concentration during an alarm is reported in the Conc/Data field of the reset event. This supplements the concentration reported in the Alarm event, which is the first concentration reported by the Vertex after an alarm threshold is first exceeded.

Each event record contains the following minimum information:

- Date and time of the event
- Module name
- An event message which may include alarm status, user login state or a comment.
- Logging station computer name

To view the event log, choose Main Screen, Review and then Event History.

Unless sorted, Vertex displays events in descending order with the most recent event at the top of the display.

Sort Options

Sorting arranges data according to the values in one of the sort lists. The default sorting of events is chronologically with the most recent events first.

If the data base is large, the sort may take a while.

Date/Time	Event	Module	Point	Gas	Conc./Data	Unit	Message	UserID
9/4/08 1:31:21 PM	MAINT FAULT	Az1-1	1	NH3	6.67	ppm	114 Excessive Point Vacuum	
9/4/08 1:31:20 PM	INFO	Az1-1	1	NH3	60.26	ppm	Flow Corrected	
9/4/08 1:30:56 PM	TWA	Az1-1	0		0.0		New Time Weighted Average Started	
9/4/08 1:30:54 PM	INFO	Az1-1	0		0.0		Start Monitor	
9/4/08 1:30:50 PM	RUNTIME	Az1-1	0		0.0		Command - Start Monitoring	DEF-AULT
9/4/08 1:30:38 PM	RESET FAULT SIMULATE	Az1-1	0		0.0		Simulate Instrument Fault	
9/4/08 1:30:35 PM	USER RESET	Az1-1	0		0.0		Simulate Instrument Fault	DEF-AULT
9/4/08 1:29:11 PM	FAULT SIMULATE	Az1-1	0		0.0		Simulate Instrument Fault	
9/4/08 1:19:07 PM	SIM-FAULT REQUEST	Az1-1	0		0.0		Command - Require Inst-Fault Simulation	DEF-AULT
9/4/08 1:21:09 PM	ALM SIMULATE	Az1-1	1	NH3	12.5	ppm	Simulate AL1	
9/4/08 1:28:06 PM	SIM-ALM REQUEST	Az1-1	1		0.0		Command - Require Alarm 1 Simulation	DEF-AULT
9/4/08 1:28:48 PM	TWA	Az1-1	7	NH3	0.0	ppm	Time Weighted Average	

Filter Options

Apply filters to find a subset of events in the log. A filtered list displays only the rows that meet the criteria you specify.

Note:

Changes to sort and filter options will not take effect until you press Apply/Refresh.

<< >>

Horizontal scroll to show additional fields.

Apply/Refresh

Touch to apply the selected sort or filter or filter options.

Page Up/Page Down

Vertical scroll to show additional records.

Figure 4-6. Event History

150.100.41.152 - Full Control

Date/Time	Event	Module	Point	Gas	Conc./Data	Unit	Message	UserID
9/4/08 1:31:21 PM	MAINT FAULT	Az1-1	1	NH3	6.67	ppm	114 Excessive Point Vacuum	
9/4/08 1:31:20 PM	INFO	Az1-1	1	NH3	60.26	ppm	Flow Corrected	
9/4/08 1:30:56 PM	TWA	Az1-1	0		0.0		New Time Weighted Average Started	
9/4/08 1:30:54 PM	INFO	Az1-1	0		0.0		Start Monitor	
9/4/08 1:30:50 PM	RUNTIME	Az1-1	0		0.0		Command Start Monitoring	DEFAULT
9/4/08 1:30:38 PM	RESET FAULT SIMULATE	Az1-1	0		0.0		Simulate Instrument Fault	
9/4/08 1:30:35 PM	USER RESET	Az1-1	0		0.0		Simulate Instrument Fault	DEFAULT
9/4/08 1:29:11 PM	FAULT SIMULATE	Az1-1	0		0.0		Simulate Instrument Fault	
9/4/08 1:29:07 PM	SIM FAULT REQUEST	Az1-1	0		0.0		Command Require Inst Fault Simulation	DEFAULT
9/4/08 1:28:59 PM	ALM SIMULATE	Az1-1	1	NH3	12.5	ppm	Simulate ALM	
9/4/08 1:28:55 PM	SIM-ALM REQUEST	Az1-1	1		0.0		Command Require Alarm 1 Simulation	DEFAULT
9/4/08 1:28:48 PM	TWA	Az1-1	7	NH3	0.0	ppm	Time Weighted Average	

Filter Options: Sort Options:

On Date: [] Module: All Logging Station: All

Date Range: From: 8/22/2008 To: 9/5/2008 Point: All User Id: All

Show All Dates: Max Records: 500 Event: All

Total: 600

<< >> PageUp PageDown

Apply/Refresh Display All

More Fields Print

Save

Display All
Removes filtering.

Print
Prints current query. Before printing, note that Event History can be quite long. The “total” figure shows the number of events.

Save
Saves current query to an Access database.

Figure 4-7. Event History

Date fields
Defaults to current date. The default range is current date and the previous two weeks.

Date/Time	Event	Module	Point	Gas	Conc./Data	Unit	Message	UserID
9/4/08 1:31:21 PM	MAINT FAULT	Az1-1	1	NH3	6.67	ppm	114 Excessive Point Vacuum	
9/4/08 1:31:20 PM	INFO	Az1-1	1	NH3	60.26	ppm	Flow Connected	
9/4/08 1:30:56 PM	TWA	Az1-1	0		0.0		New Time Weighted Average Started	
9/4/08 1:30:54 PM	INFO	Az1-1	0		0.0		Start Monitor	
9/4/08 1:30:50 PM	RUNTIME	Az1-1	0		0.0		Command - Start Monitoring	DEFAULT
9/4/08 1:30:38 PM	RESET FAULT SIMULATE	Az1-1	0		0.0		Simulate Instrument Fault	
9/4/08 1:30:35 PM	USER RESET	Az1-1	0		0.0		Simulate Instrument Fault	DEFAULT
9/4/08 1:29:11 PM	FAULT SIMULATE	Az1-1	0		0.0		Simulate Instrument Fault	
9/4/08 1:29:07 PM	SIM FAULT REQUEST	Az1-1	0		0.0		Command - Require Inst Fault Simulation	DEFAULT
9/4/08 1:28:58 PM	ALM SIMULATE	Az1-1	1	NH3	12.5	ppm	Simulate Al 1	
9/4/08 1:28:55 PM	SIM-ALM REQUEST	Az1-1	1		0.0		Command - Require Alarm 1 Simulation	DEFAULT
9/4/08 1:28:48 PM	TWA	Az1-1	7	NH3	0.0	ppm	Time Weighted Average	

Maximum Records
Use to limit the number of records to display. Vertex will display up to 10,000 records. The default setting is 500. Use the up and down arrow buttons to increment the value by 100.

Advance Filter Options
Use the Advance Filter Option buttons located to refine the sort.



Figure 4-8. Event History

Advanced Filter Options-Events

Use to filter on specific alarms, faults or other events.

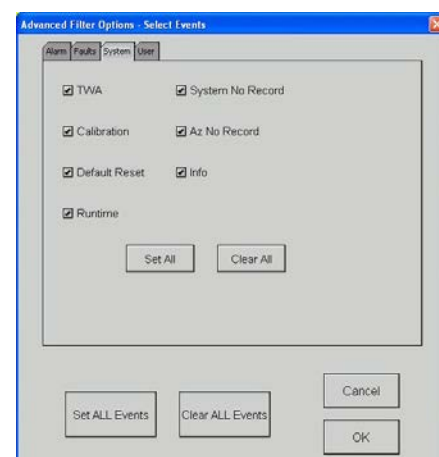
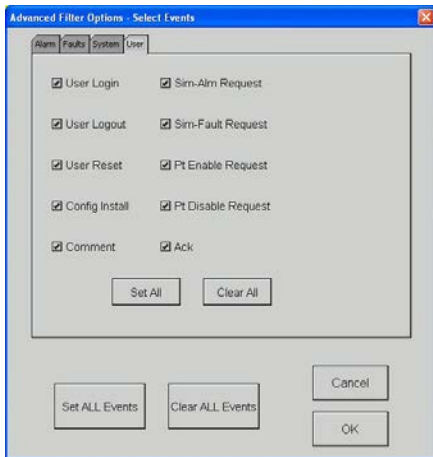
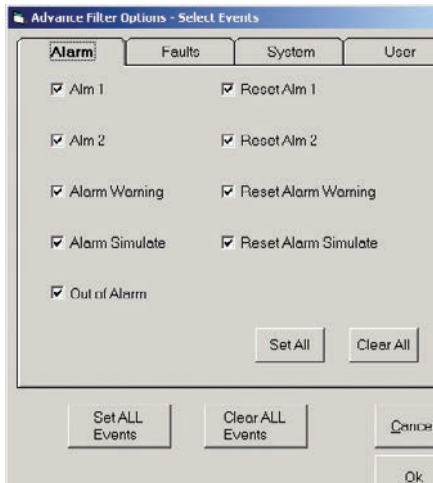

Figure 4-9. Filter Options

Select Filter Options-Modules

Use to filter events based on specific points, analyzers or other hardware modules.

Advanced Filter Options - Select Modules

Select desired Modules

Az 1-1 Az 1-2 Az 1-3

Az 2-1 Az 2-2 Az 2-3

Az 3-1 Az 3-2 Az 3-3

Set All Clear All

Select Pts

◇ Point 1 ◇ Point 2

◇ Point 3 ◇ Point 4

◇ Point 5 ◇ Point 6

◇ Point 7 ◇ Point 8

◇ All 8 Pts

Set All Clear All

OPC PLC HMI

Set All Clear All

Cancel OK

Figure 4-10. Filter Options

Select User ID or Logging station

Use to select a specific Vertex station or operator.

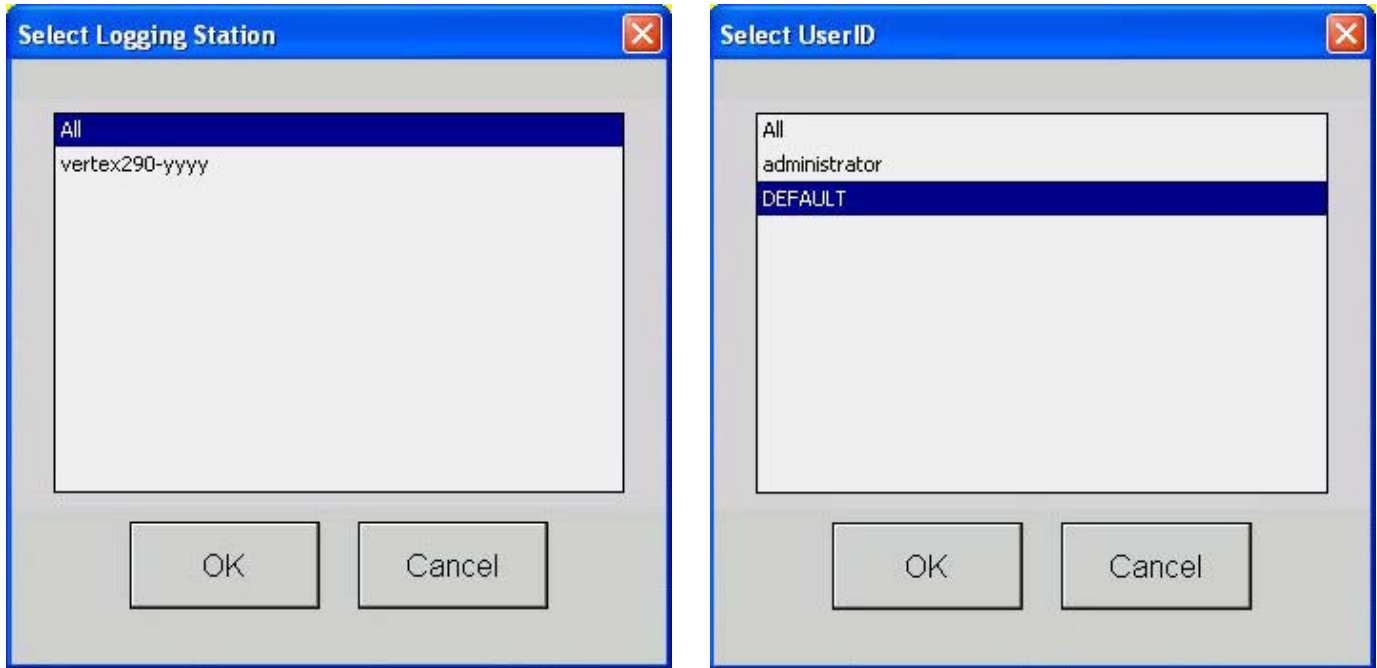

Figure 4-11. Selecting Station or ID

4.5.2 Data Trend

Vertex plots gas concentration in the Data Trend window. You may choose multiple points to plot each point a different colored line on the graph. Data displayed in the graph can be either *Stored* data from the data log or *Live* (a continuous, real-time display, scrolling right to left).

Data can only be stored if datalogging was selected in the Profile Management Utility screen. A maximum of one year of data can be stored, however faster datalogging rates may require more frequent purging. Stored data shows only concentration (not location names)



TIP

Drag a finger across the screen to zoom into the area selected

Information for each point appears in the table to the left of the graph.

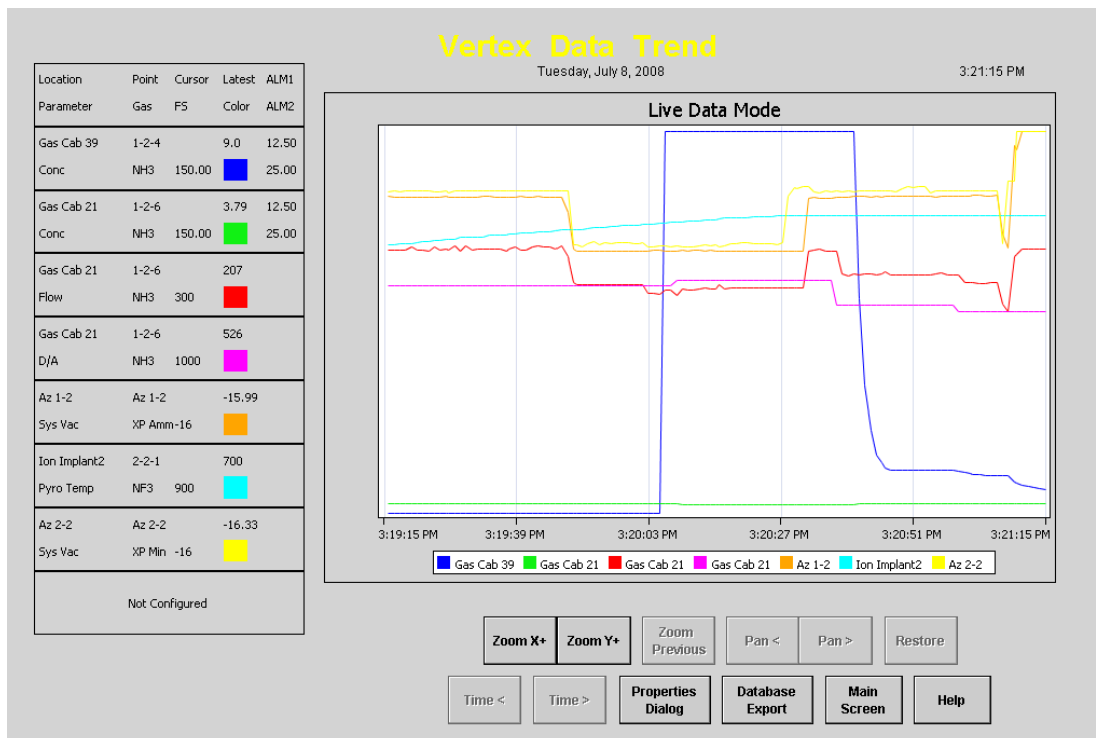

Figure 4-12. Data Trend

Vertex M™ 24-Point Continuous Monitor

Use the Properties window (bottom right) to select locations and data to include in the Data Trend. Selection options include the

Y axis data: points to display (to a maximum of 8), the data to display (live or stored) and the time span; and the

X axis data: one, some or all detection values.



TIP

Touch Help for additional information on using the Properties dialog.

Properties

You can select up to 8 pens

Point 1-1-1 NH3	Point 1-1-5 NH3	Not Configured	Not Configured	Point 1-3-1 NH3	Point 1-3-5 NH3
Point 1-1-2 NH3	Point 1-1-6 NH3	Not Configured	Not Configured	Point 1-3-2 NH3	Point 1-3-6 NH3
Point 1-1-3 NH3	Point 1-1-7 NH3	Not Configured	Not Configured	Point 1-3-3 NH3	Point 1-3-7 NH3
Point 1-1-4 NH3	Point 1-1-8 NH3	Not Configured	Not Configured	Point 1-3-4 NH3	Point 1-3-8 NH3
Not Configured	Not Configured	Not Configured	Not Configured	Point 2-3-1 NH3	Point 2-3-5 NH3
Not Configured	Not Configured	Not Configured	Not Configured	Point 2-3-2 NH3	Point 2-3-6 NH3
Not Configured	Not Configured	Not Configured	Not Configured	Point 2-3-3 NH3	Point 2-3-7 NH3
Not Configured	Not Configured	Not Configured	Not Configured	Point 2-3-4 NH3	Point 2-3-8 NH3
Not Configured	Not Configured	Point 3-2-1 NF3	Point 3-2-5 NF3	Point 3-3-1 NH3	Point 3-3-5 NH3
Not Configured	Not Configured	Point 3-2-2 NF3	Point 3-2-6 NF3	Point 3-3-2 NH3	Point 3-3-6 NH3
Not Configured	Not Configured	Point 3-2-3 NF3	Point 3-2-7 NF3	Point 3-3-3 NH3	Point 3-3-7 NH3
Not Configured	Not Configured	Point 3-2-4 NF3	Point 3-2-8 NF3	Point 3-3-4 NH3	Point 3-3-8 NH3

Currently selected point : Point 2-3-5

X Axis configuration

Live Data
 Stored Data

Start Date: ...

Start Time is current time in live data mode

Time Span: hour(s)

Y Axis configuration

Conc
 Flow
 Val D/A
 Pyro Temp
 Sys Vac

4.5.3 Optional ChemCam

The Vertex ChemCam option provides a means to observe the stains on the last window of a Chemcassette® tape. It consists of a small video camera located between the Chemcassette® take up reel and the optic head. The Vertex System records images of the stains in either AutoPicture mode or by a ChemCam Live capture. See [Section 3.6.3 Set Analyzer Window](#) for more information.

Note:

Some faint stains may not be visible via the camera.

To use the ChemCam window, touch Main Screen, Review and then ChemCam.

ChemCam Live

Use the ChemCam Live tab to manually save an image to the ChemCam database.

1. Touch the image you have selected for capture. The border around the image will turn green.
2. Enter comments about the image in the Comment text box.
3. Touch Capture. The border on the image will turn red.
4. When the border returns to green, the capture is complete. Choose an additional image to capture or touch Close.

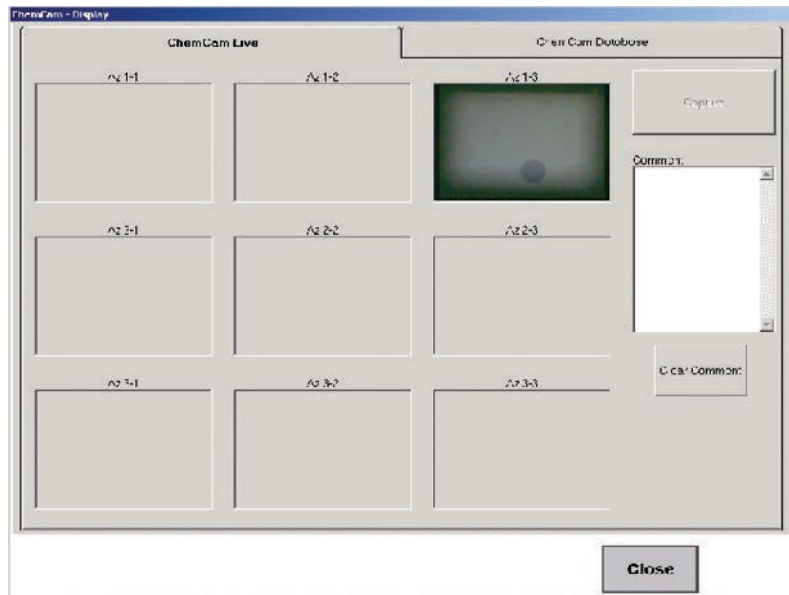

Figure 4-13. ChemCam Window

ChemCam Database

Use the ChemCam Database tab to review, print or delete records in the ChemCam database. The Refresh button updates the window with records stored since the window was opened.

Every record in the database includes the following:

- Time and date of capture
- Type of capture (manual or automatic)
- Analyzer associated with the database entry
- Chemcassette® serial number
- Computer name

Additional information for records stored by ChemCam AutoPicture includes

- Point number which triggered the alarm
- Gas concentration at the time of alarm
- Unit of measure for the concentration
- The alarm level the concentration reached
- The location ID

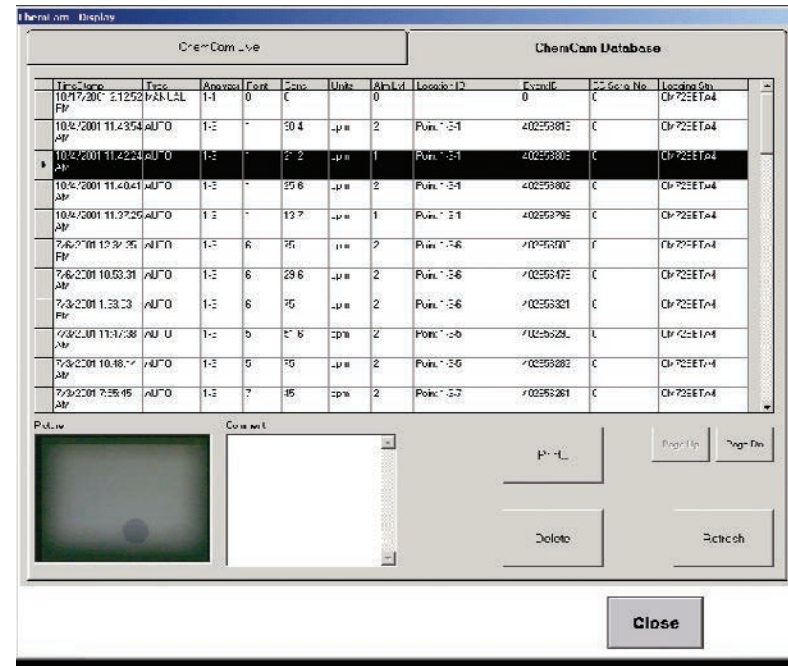
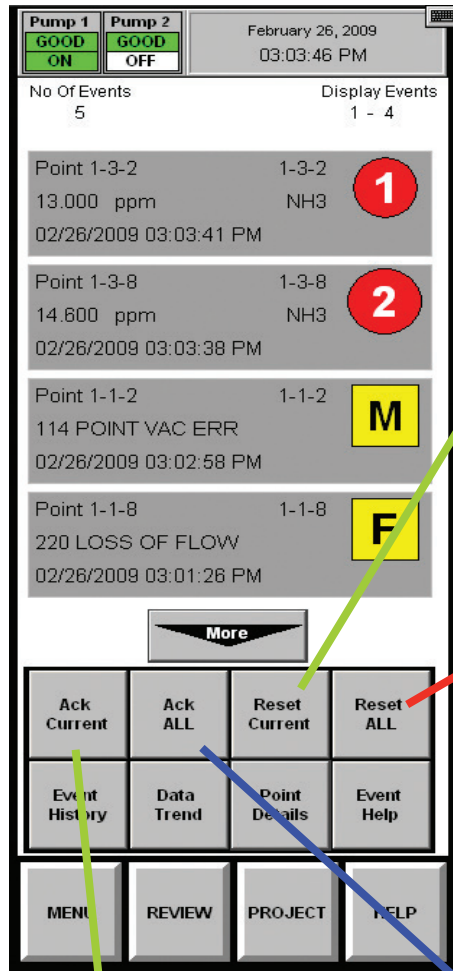

Figure 4-14. ChemCam Database

4.5.4 Event List

With the Event List, view and acknowledge active alarms and faults. Vertex M displays the newest event at the top of the list. Scroll through the events with

the Back and More buttons. To select an event as the current event, touch the event. The current event will have a green border.



Reset Current

Clears the active event from the list. If the problem has not been resolved, events will continue to occur.

Reset All

Clears all events from the list. Reset All is not instantaneous. Vertex M may not remove events from the list for several seconds.

Ack All

Acknowledges an operator has seen all of the events

Ack Current

Acknowledges an operator has seen the current event

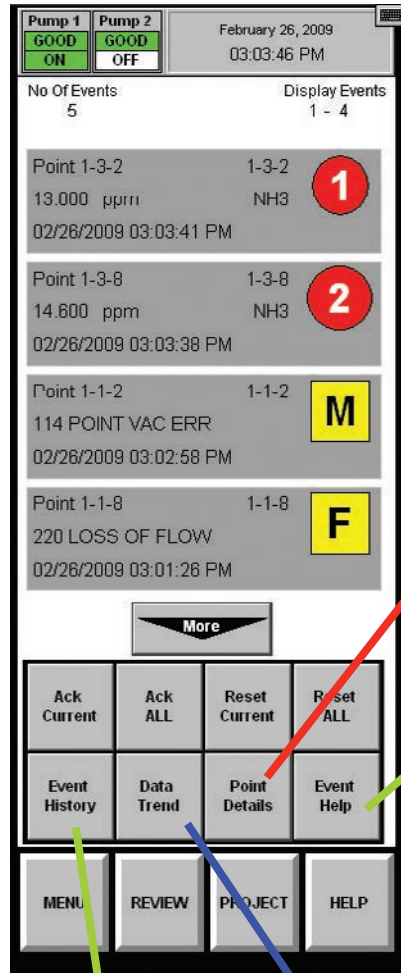

Point Details
Displays point detail for current selected point

Event Help
Displays the HTML help file designated for the point. Point help files are linked in the configuration utility.

Event History
Opens the Event History window

Data Trend
Opens the Data Trend window

4.6 Menu Buttons

Use the buttons in Menu to perform:

- [4.6.1 Run Time Options](#)
- [4.6.2 Flow Calibration](#)
- [4.6.3 Maintenance](#). See also [Section 5 Maintenance](#).
- [4.6.4 Diagnostics](#)
- [4.6.5 Service](#)
- [4.6.6 Security Access](#)
- [4.6.7 Configuration](#). See also [Section 3.6 Configuration Utility](#).

4.6.1 Run Time Options

Use the Run Time Options Window to perform one of the following four functions:

- Start or stop an analyzer from monitoring
- Enable or temporarily disable a point
- Enable or temporarily disable an alarm
- Enter a comment event into the event list

A point or alarm disabled in the Run Time Options window will remain disabled until it is again enabled in this window. However, an event window will open to remind operators the alarm or point is no longer providing coverage. The event will occur after the timeout period set in the configuration window.

Vertex M always displays the following items in the Run Time Options window.

To Start or Stop an Analyzer from Monitoring

Stopping an analyzer from monitoring prevents the system from triggering false alarms during testing and maintenance.

1. Choose Monitoring from the function buttons at the bottom of the screen.
2. Select the analyzer(s) from the keypad. The selected analyzer(s) will turn dark gray on the keypad.
3. Choose Stop or Start Monitor to change the state of the analyzer.

The status indicator changes to reflect the current status on the main screen, and on the analyzer button on the keypad.

Stop/Start Monitor

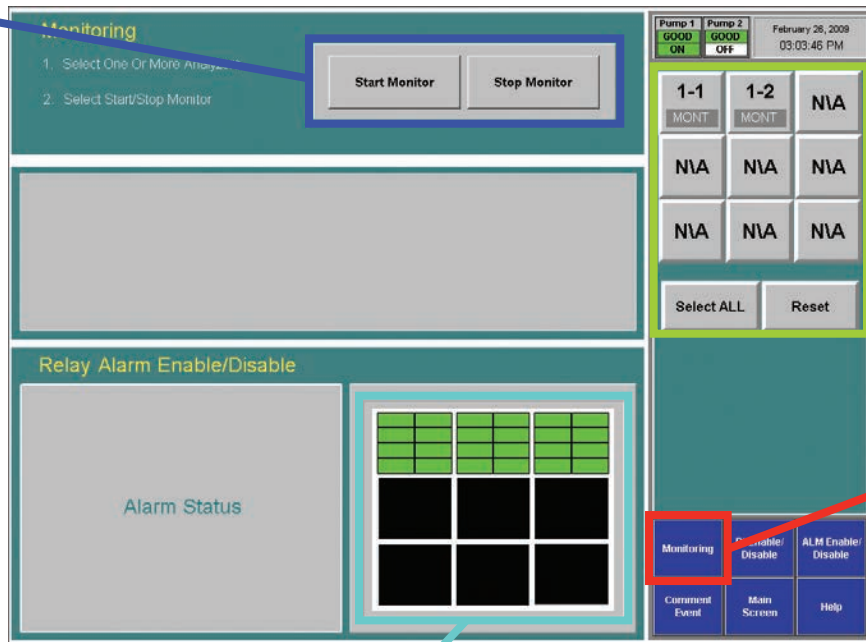

Analyzer Keypad

Monitoring Screen

Point Status

To Disable or Enable a Point

Disabling a point prevents the system from triggering false alarms during testing and maintenance. Vertex M will not perform point specific fault checks on disabled points.

1. Choose Point Enable/Disable from the function buttons.
2. Select the analyzer and point from the keypad. The selected point buttons turn dark gray on the keypad.

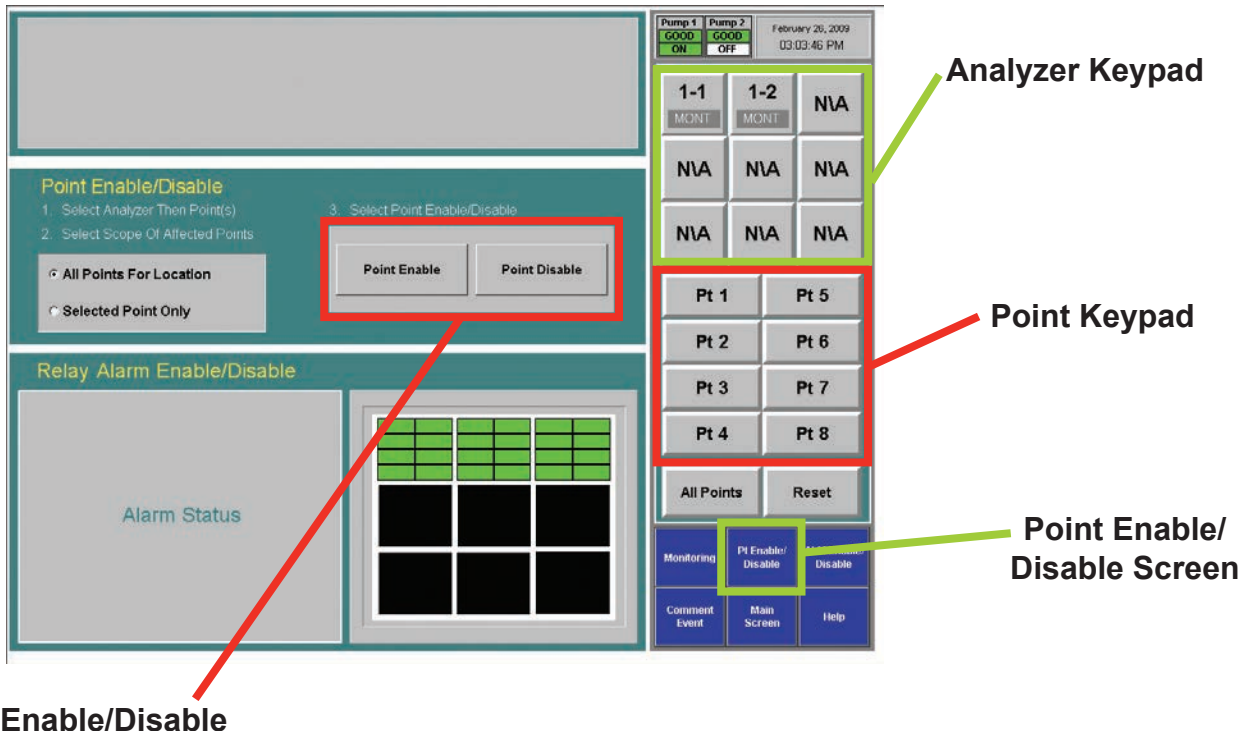

3. Choose Selected Point Only to enable / disable a single point

or

Choose All Points for Location to enable / disable all of the points monitoring a location.

4. Touch Point Enable or Point Disable to change the state of the point.

A disabled point turns light grey. An enabled point is green in the point status window.

**Gas Point
or
Gas Location**

Point Status Window

Point Enable/Disable

Point Enable/Disable

Pump 1	Pump 2	February 26, 2009	
GOOD	GOOD	03:03:46 PM	
ON	OFF		

1-1	1-2	N/A
MONT	MONT	
N/A	N/A	N/A
N/A	N/A	N/A
Pt 1	Pt 5	
Pt 2	Pt 6	
Pt 3	Pt 7	
Pt 4	Pt 8	
All Points	Reset	

Monitoring	Pt Enable/ Disable	Al M Enable/ Disable
Comment Event	Main Screen	Help

To Disable or Enable Alarms

Disabling alarms prevents the system from triggering false alarms during testing and maintenance.

1. Select the analyzer and point from the keypad. The selected points turn dark gray on the keypad.
2. Choose Selected Point Only to enable / disable an alarm on a single point

or

Choose All Points for Location to enable / disable all of the alarms associated with a location.

3. Touch Alarm Enable or Alarm Disable to change the state of the point. A disabled alarm turns light blue. An enabled alarm turns green in the point status window.

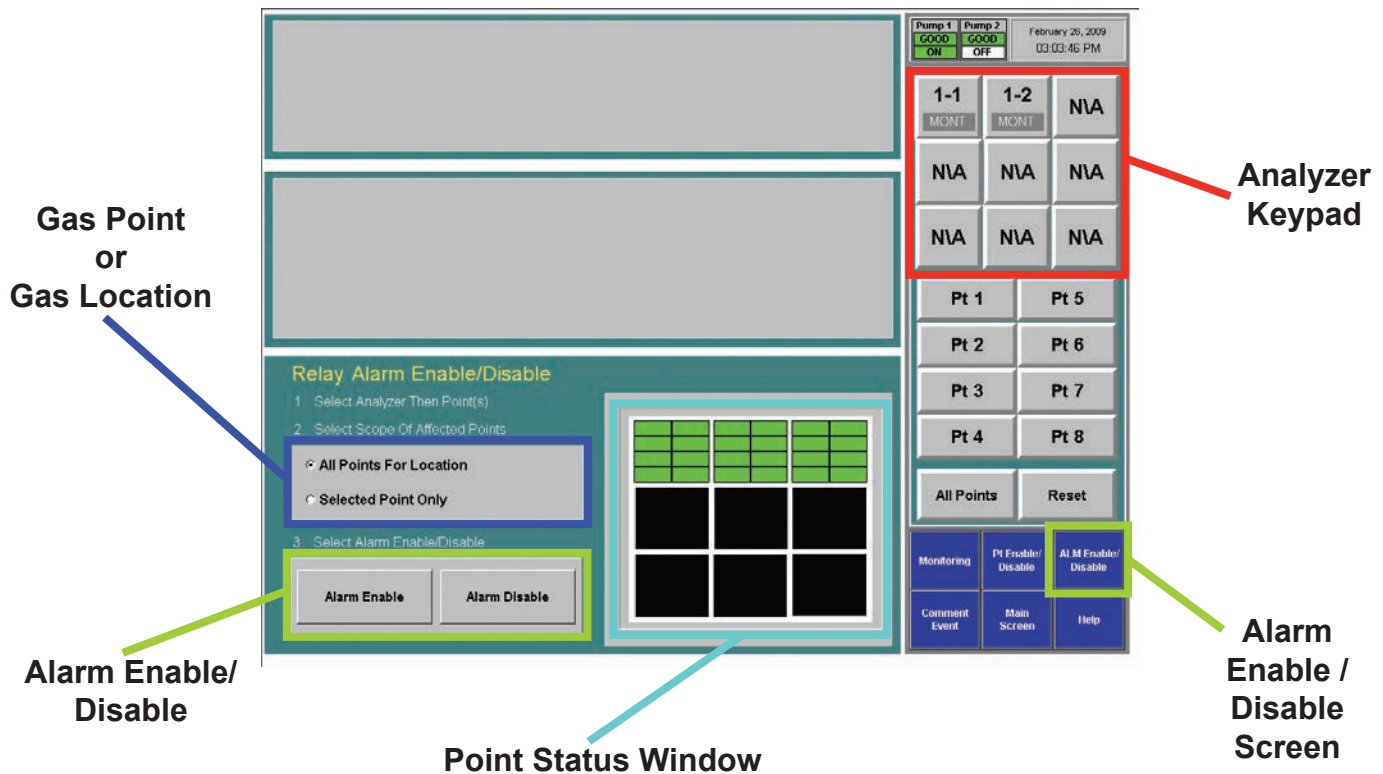

Comment Event

Use Comment Event to enter information about a point or analyzer that Vertex M would not automatically enter into the database. The comment is stored in Event History.

1. To enter a comment:
2. Touch Comment Event.
3. Enter the text for the event.
4. Choose analyzer and point to associate with the comment (optional).
5. Touch Create Event.

The comment event is associated with the analyzer and point selected on the keypads. To enter a comment independent of a point, choose Reset Az & Pt.

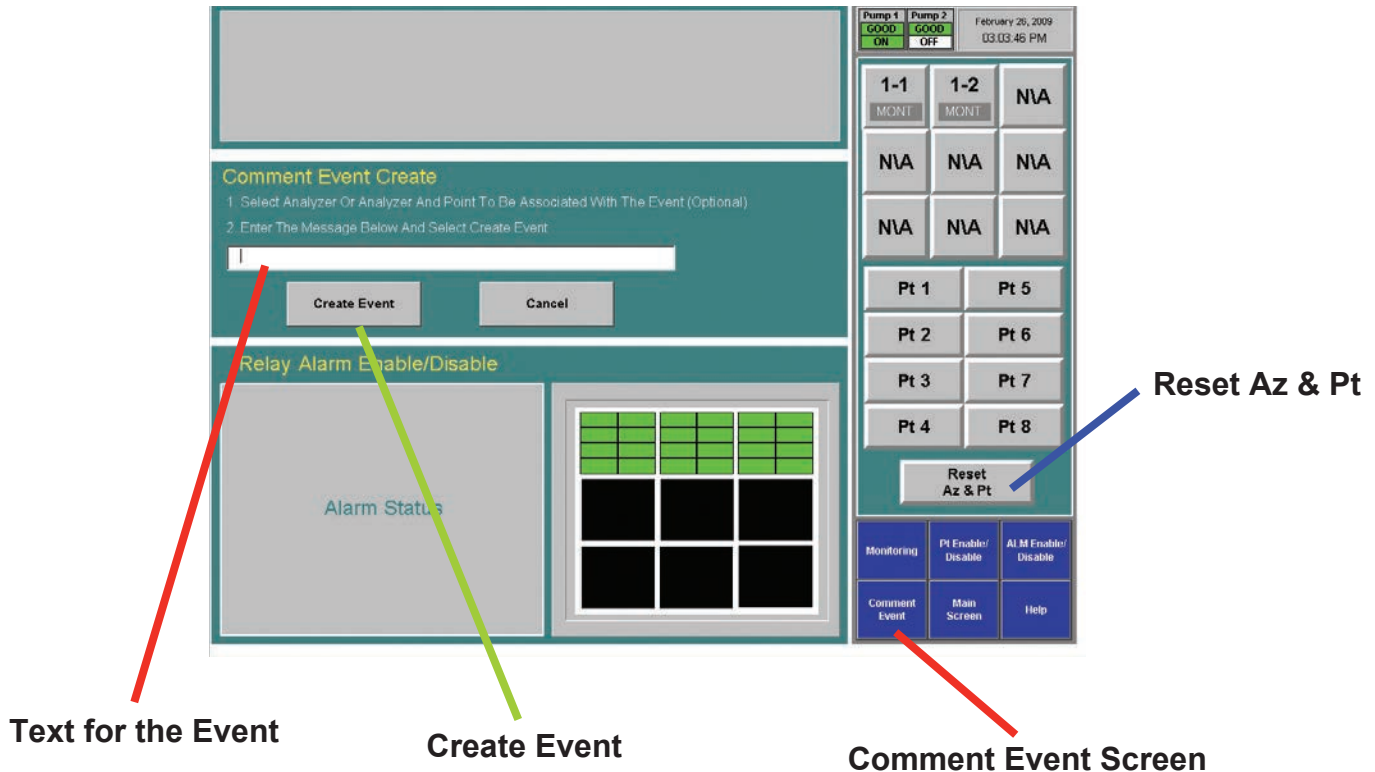

4.6.2 Flow Calibration

The Vertex M System requires exact flow rates and vacuum levels for accurate gas detection. Factors which affect proper flow setup are sample line length, the type of analyzer installed, the condition of the filters, and the supply vacuum level.

To open the Flow Calibration Window, choose Main Screen, Menu, Runtime Options, Calibration.

The Flow Calibration Window

The Flow Calibration window consists of three parts:

- Flow display
- Analyzer selection pad
- Function buttons

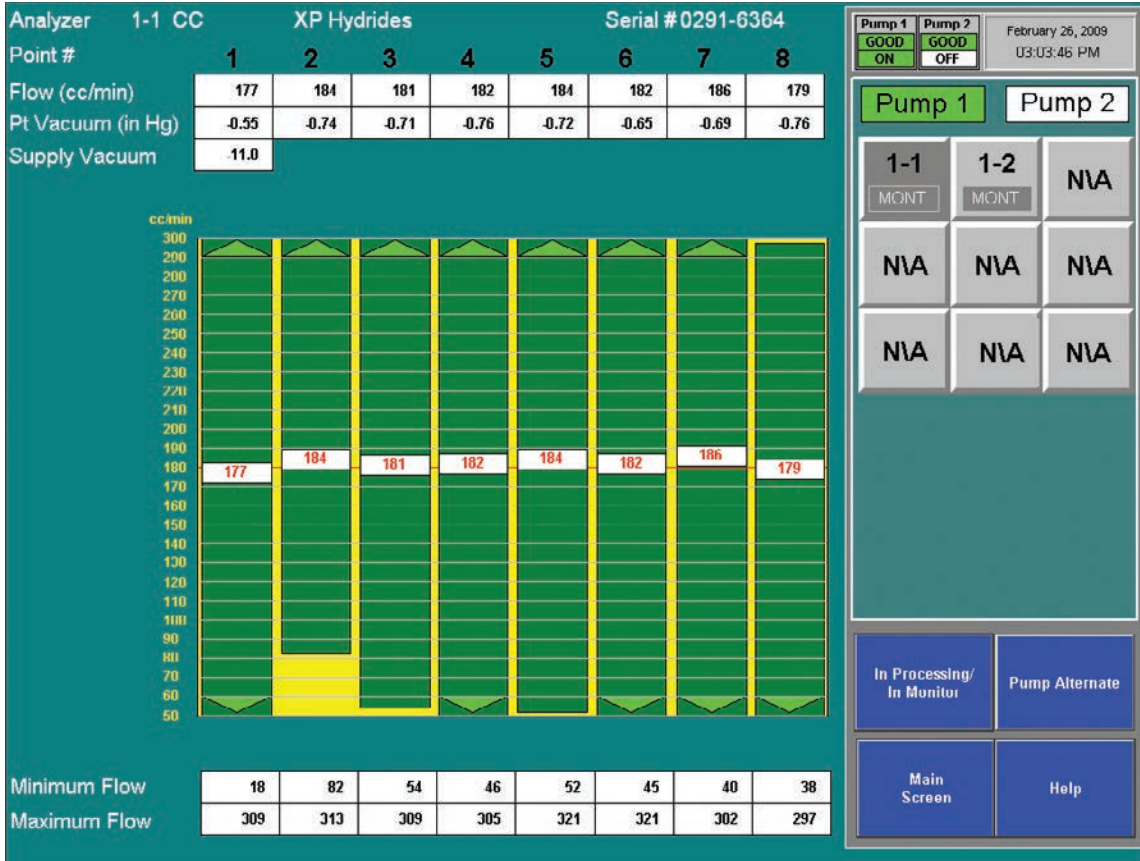

Vertex M™ 24-Point Continuous Monitor

Flow Display

The flow display shows information critical to verifying the flow rate for each point.

Choose the analyzer from the selection pad in the upper right-hand corner. The eight points display their flow.

Flow (cc/min)

The real-time sample flow to the point

Point Vacuum (in Hg)

Pt. Vacuum indicates the restriction from sample line length and the pressure developed by shared lines

Supply Vacuum

Typical supply vacuum is 10-13 inches Hg

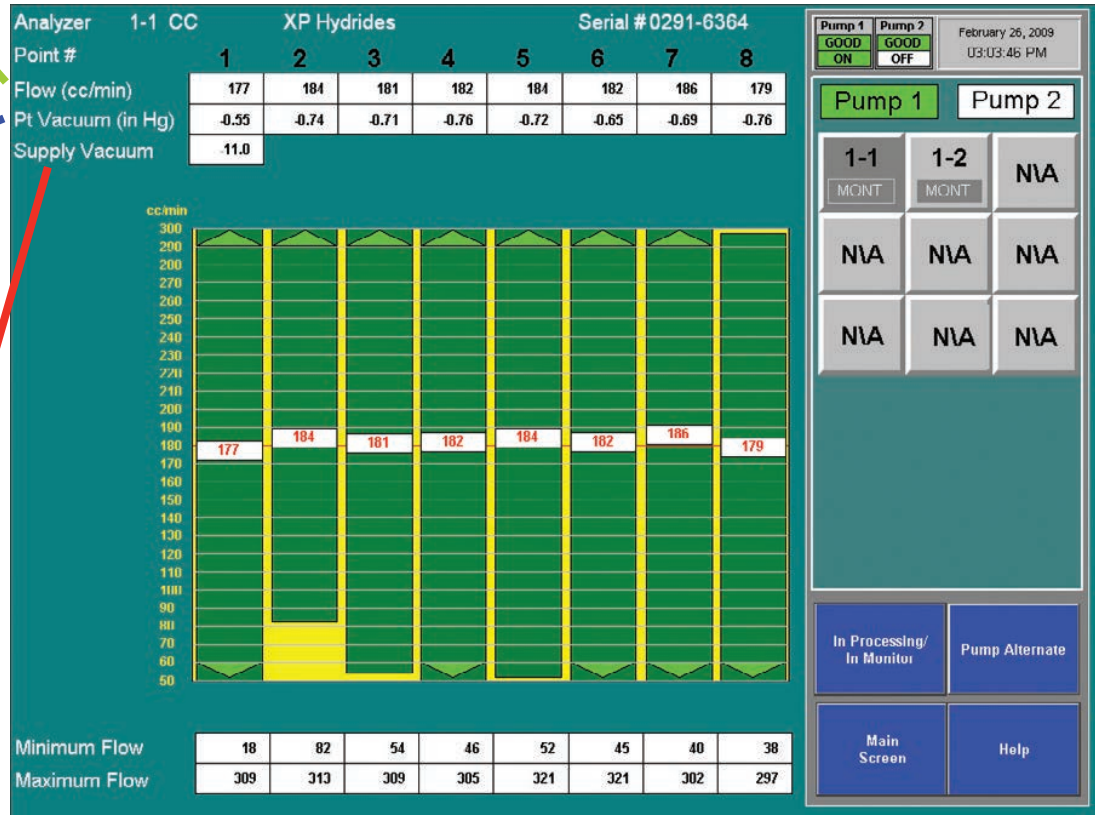

Vertex M™ 24-Point Continuous Monitor

Proportional Value Range

A vertical green bar displays the dynamic range over which the proportional valve can adjust the flow rate. Indicated numerically by Minimum Flow and Maximum Flow.

Minimum Flow

The minimum flow possible with the attached sample line and orifice

Maximum Flow

The maximum flow possible with the attached sample line and orifice

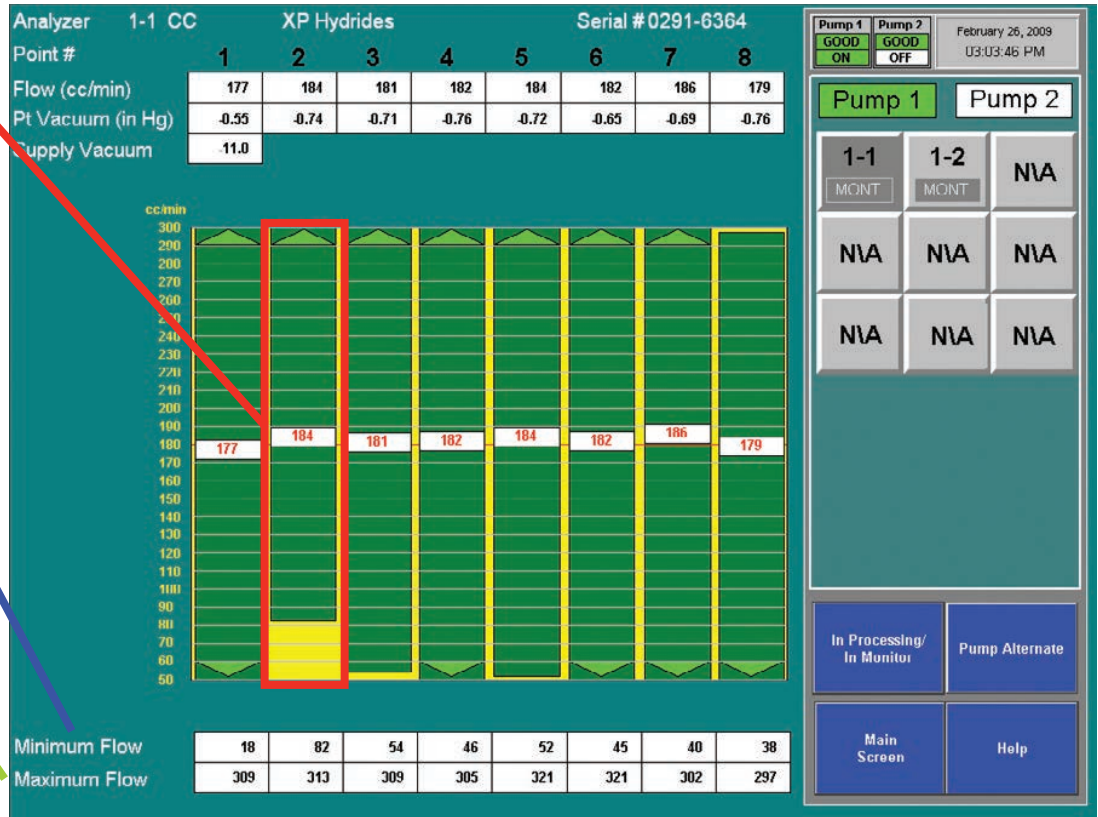

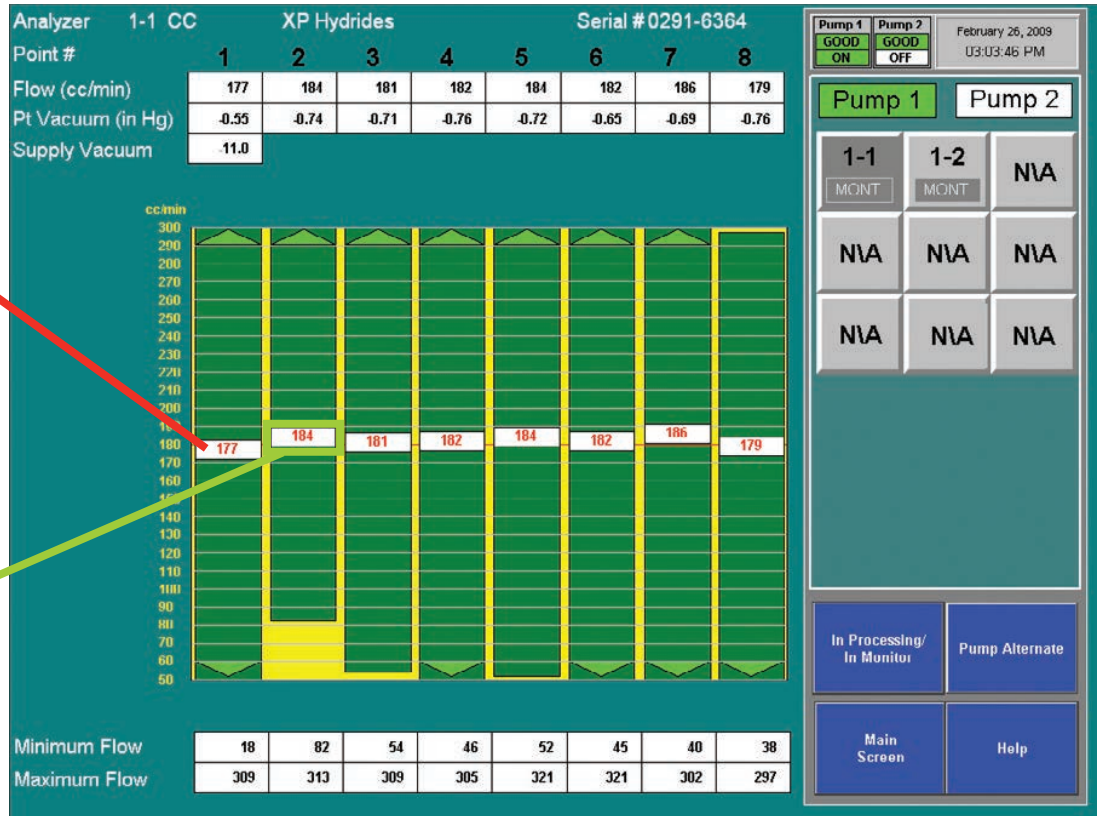

Target Flow

A horizontal red line indicates the target flow rate required by the Vertex M System for correct analysis. The target flow rate is 180 cc/min +/-5% (171-189 cc/min)

Flow Rate

A floating white box indicates the actual flow rate. The position of the box graphs the flow; the numerical value of the flow is displayed in the box.

Function Buttons

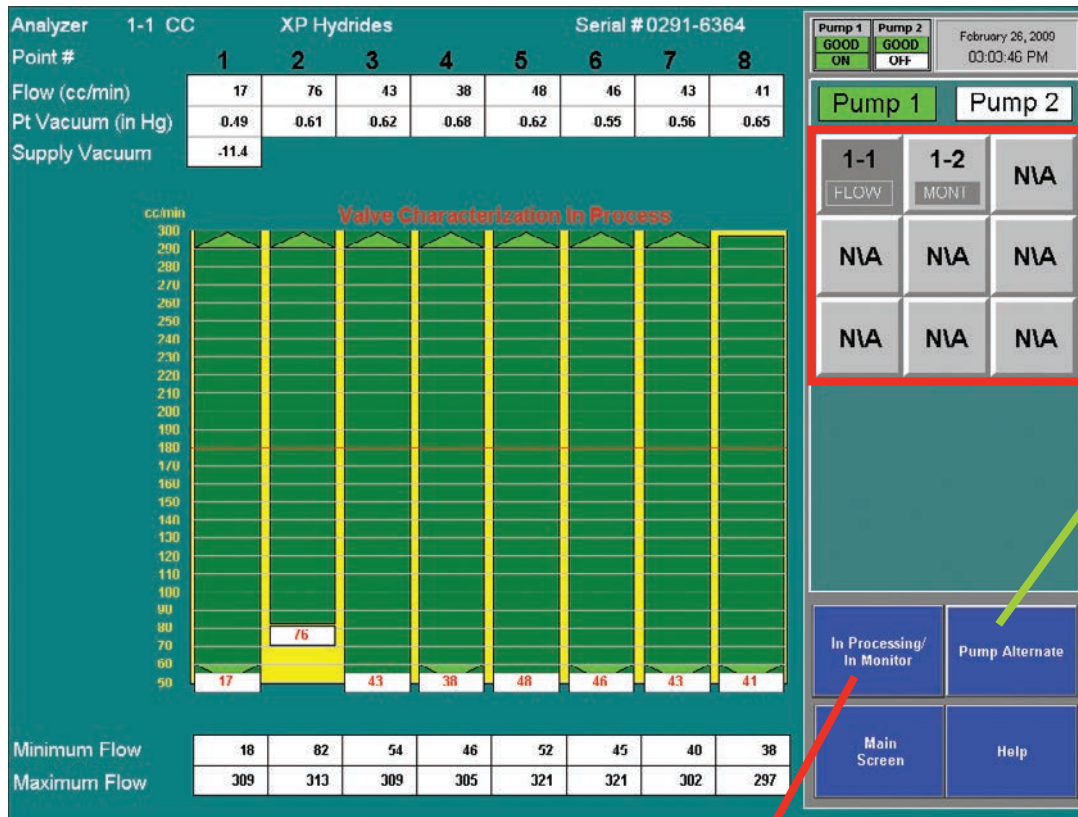

Selection Pad

Pump Alternate
Toggles between pumps 1 and 2

Auto Balance
Characterizes the control range of the proportional value

Auto Balance the Flow Rate

Note:

All analyzers should be in Monitor except for the one being Auto Balanced.

Perform an Auto Balance for the following reasons:

- When a line length is changed
- If end-of-line filters are replaced
- The gas family changes
- When a new Chemcassette® is installed
- When analyzers are added to a Vertex M rack

To perform an Auto Balance:

1. Make sure Chemcassette® is installed.
2. Set analyzer to idle (not monitoring). See [Section 4.6.1 Run Time Options](#) for the procedure.
3. If not already open, touch Main Screen, Menu, Calibration. The Flow Diagnostic window opens.
4. Choose analyzer from the selection pad in the upper right-hand corner.
5. Touch the Auto Balance function button. Vertex M will characterize the flow between minimum and maximum. This data will be used to set the flow to 180 cc/min. when you return the analyzer to monitor mode. Autobalancing takes approximately 130 seconds to complete.
6. If required, repeat for other analyzers.

Note:

If Vertex M cannot adjust the flow to the proper range (150 to 210 cc per minute at worst case condition) consult Honeywell Analytics service.

Vertex M™ 24-Point Continuous Monitor

Flow Calibration During Auto Balance

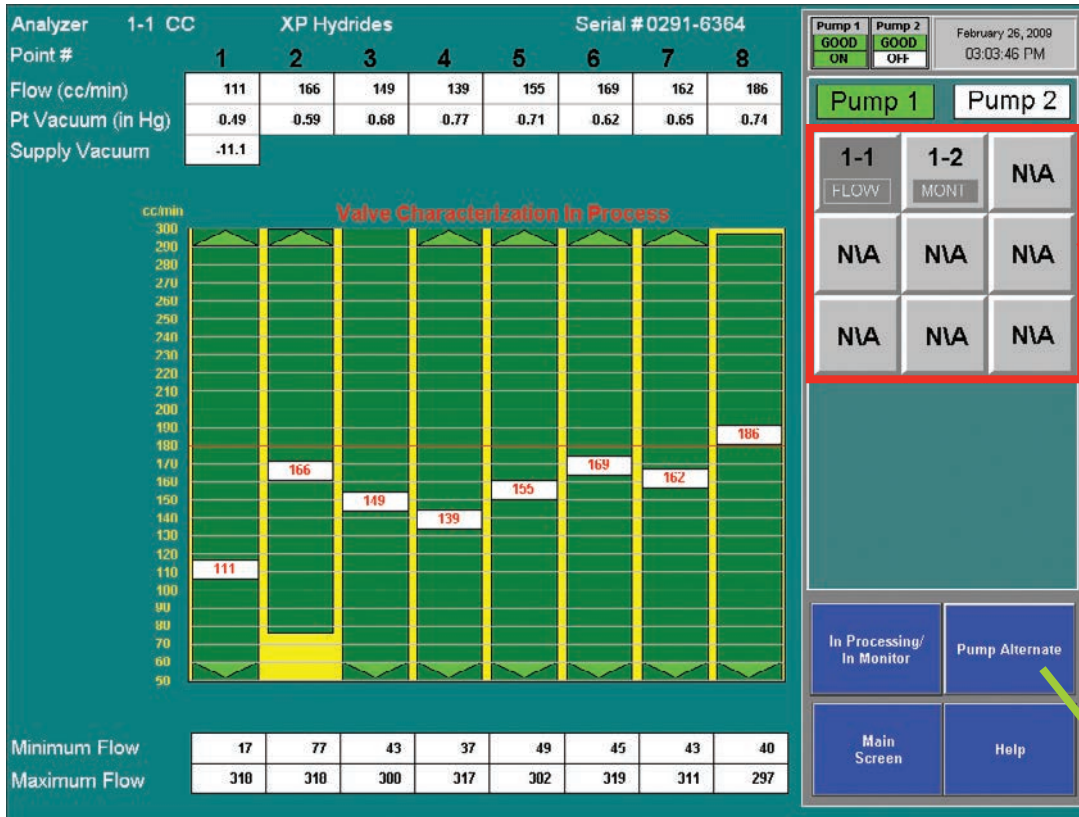

Selection Pad

Pump Alternate
Toggles between
pumps 1 and 2

4.6.3 Maintenance

Use the Maintenance window to:

- Load and change Chemcassette® tape. See [Section 5.3.4 Change Chemcassette® Tape](#).
- Change filters. See [Section 5.3.3 Replace Filters](#).
- Analyzer operation utilities (see the following pages)

Analyzer Operation Window

The Analyzer Operation provides four utility functions which may be useful when performing service on an analyzer.

- Tape Advance and Release Analyzer can be performed while analyzer is in monitor.
- Open Gate and Close Gate can only be performed in idle mode

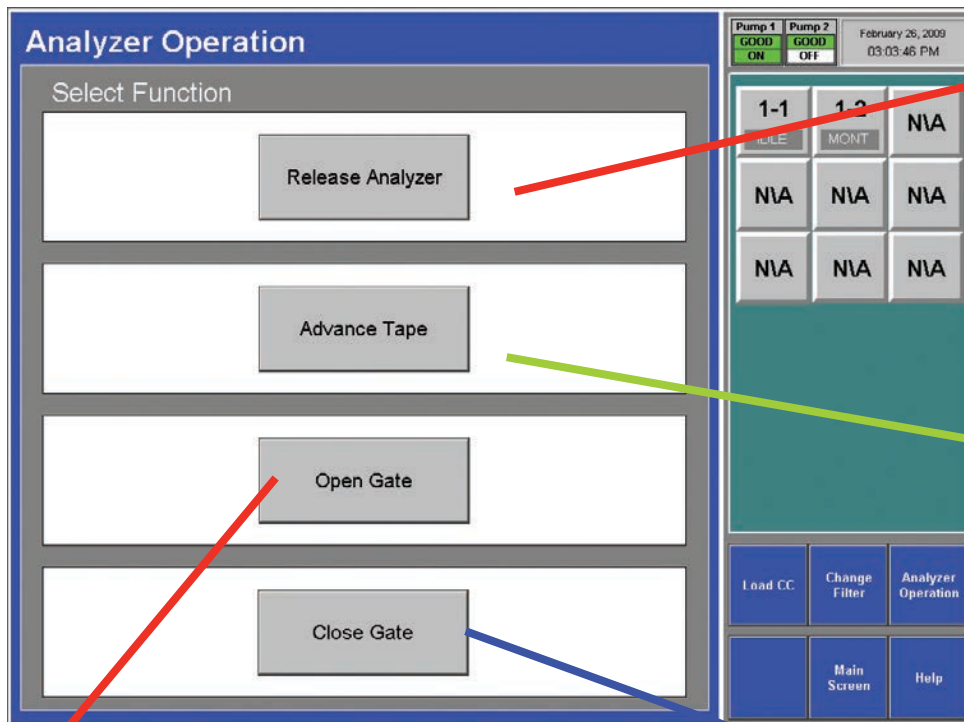

Release Analyzer

Unlocks analyzer so that you may slide it out of the cabinet

Advance Tape

Pulls a fresh section of tape into the detection head. Press once to see stains developed on points 1-4. Press twice for points 5-8.

Open Gate

Opens the optics head to release tape

Close Gate

Closes optics head

To Open Gate

Set analyzer to idle in the Runtime Options window.

1. Touch Main Screen, Menu, Maintenance then Analyzer Operations.
2. Touch the module number on the module keypad.
3. Select Gate Open.
4. When finished, press Gate Close and return analyzer to monitor mode in Runtime Options window.

4.6.4 Diagnostics

Use the Diagnostics Window to review operational settings and information about either an individual analyzer or the Vertex M System. To open the Diagnostics Window, touch Menu and then Diagnostics.

System Information - Displays the profile ID number, Profile name and other critical system information.

The Profile ID is a unique number generated whenever the Vertex M Profile Management utility saves a configuration file. Vertex M stores the ID number in the DAq, the PLC and each analyzer. If the profile ID numbers do not match, a fault is generated and monitoring will not start.

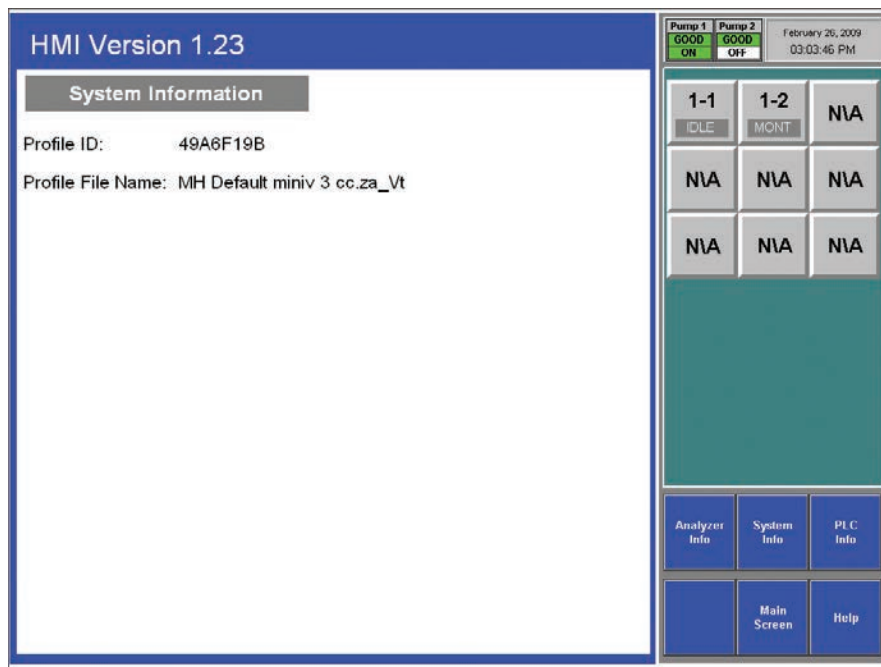

Choose the analyzer from the selection pad in the upper right-hand corner. Analyzer Information lists the following:

- Profile ID - The Profile ID is a unique number generated whenever the Vertex M Profile Management utility saves a configuration file. Vertex M stores the ID number in the DAq, the PLC and each analyzer. If the profile ID numbers do not match, a fault is generated and monitoring will not start.
- Gas family information
- Network IP address
- Analyzer software version number
- Analyzer Serial Number
- Time remaining on filter
- Time remaining on Chemcassette® tape
- Data logging settings for the analyzer
- Pyrolyzer analyzers will also display the pyrolyzer temperature.

HMI Version 1.23

Analyzer 1-1

Profile ID: 49A6F19B
Gas Family Number: 18
IP Address: 192.168.254.101
Analyzer Revision: 01.12
Analyzer Serial Number: 0291-6364
Filter Left: 68 days
Chemcassette Tape Left: 62.6 days

DataLog Pt:	1	2	3	4	5	6	7	8
Threshold:	NEV	NEV	NEV	NEV	NEV	NEV	NEV	NEV
	5.0	5.0	5.0	5.0	5.0	5.0	5.0	5.0

Pump 1 **Pump 2** February 26, 2009
GOOD GOOD 03:03:46 PM
ON OFF

1-1 IDLE	1-2 MONT	N/A
N/A	N/A	N/A
N/A	N/A	N/A

Analyzer Info System Info PLC Info
Main Screen Help

PLC Information

Displays the profile ID number in the PLC.

The screenshot shows the HMI interface for the Vertex M 24-Point Continuous Monitor. The top left corner displays "HMI Version 1.23". The main area is titled "PLC Information" and shows "Profile ID: 44B2688F". On the right side, there is a status panel with the following elements:

- Pump 1: GOOD ON (green)
- Pump 2: GOOD OFF (green)
- Date: February 26, 2009
- Time: 03:03:46 PM

Below the status panel is a 3x3 grid of buttons:

1-1 IDLE	1-2 MONT	N/A
N/A	N/A	N/A
N/A	N/A	N/A

At the bottom of the right panel are navigation buttons: Analyzer Info, System Info, PLC Info, Main Screen, and Help.

4.6.5 Service

The Service Window provides a means to trigger the fault and alarm relays.

Create Fault Now
The Create Fault Now button will only become visible after an analyzer and fault level are selected. Touch the button to generate simulated fault.

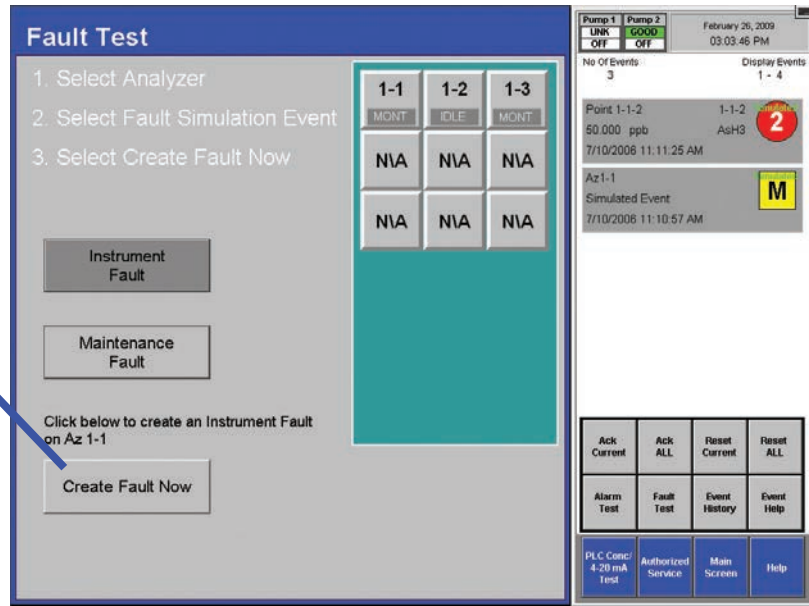

Fault Test

Use the Fault Test to verify operation of fault relays.

Note:

The fault test simulates an actual fault condition and the Vertex M System activates fault relays. Notify appropriate personnel that you plan to conduct a fault test.

To conduct a fault test:

1. Choose Main Screen, Menu, Service and then Fault Test.
2. Choose the analyzer for the fault test.
3. Choose either Instrument Fault or Maintenance Fault.
4. Choose Create Fault Now to activate the relay or relays connected to the selected analyzer and a fault will appear in the event list.
5. To continue testing, repeat steps 2 through 4.

See [Section 4.5.4 Event List](#) to clear events.

Alarm Test

Use the alarm test to simulate a gas concentration for any analyzer.

Note:

The alarm test simulates an actual alarm condition and the Vertex M System activates all alarm relays. Notify appropriate personnel that you plan to conduct an alarm test.

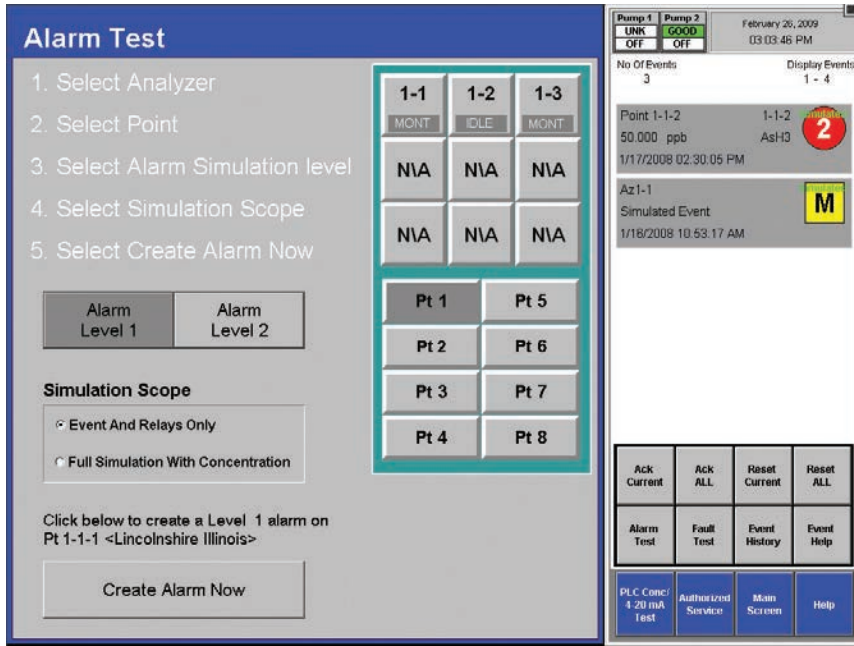

To conduct an alarm test:

1. Choose Main Screen, Menu, Service and then Alarm Test.
2. Choose the analyzer and point for the alarm test.
3. Choose an alarm level and a simulation scope. Either scope will cause an alarm to be reported on the control network, on the relays (if equipped) and on the relevant OPC tag. Furthermore, either scope will cause creation of a simulated alarm event in the event list.
4. However, if “Full Simulation With Concentration” is selected then a gas concentration will also be reported on the control network, on the associated OPC tag, on the point detail screen, and in the event. This concentration will correspond to the alarm 1 or 2 threshold concentration, depending on which is simulated. The alarm

threshold concentration is set via the configuration utility as described in [Section 3.6.4 Configure Point](#). The Create Alarm Now button becomes visible only after the prerequisite selections of analyzer, point and alarm level have been made. Pressing the Create Alarm Now button creates the simulated alarm. The above screen contains examples of how alarm simulation works. A concentration of 50 ppb is being reported over the control network and OPC on point 2-2-3. The value 50 ppb is the alarm 2 threshold for this point from the configuration profile. However no concentration is being reported for 2-2-5 because the scope was set to Event And Relays Only when this event was generated. Pressing the Create Alarm Now button above will create a level 2 alarm with concentrations on point 2-2-4.

5. To continue testing, repeat steps 2 and 3.

If you choose to simulate a Level 2 alarm, you will trigger both Level 1 and 2 relays.

See [Section 4.5.4 Event List](#) to clear events.

4-20 mA Test

Use the 4-20 mA test to test or calibrate external devices connected to the optional 4-20 mA PLC.

Note:

The 4-20 test generates an actual current output on the optional 4-20 mA PLC. Notify appropriate personnel that you plan to conduct a test.

To conduct a 4-20 mA test:

1. Choose Main Screen, Menu, Service and then 4-20 mA Test.
2. Choose the analyzer and point for the alarm test.
3. Use the up and down arrows to set the current level. Touch 20 mA Test to start the test. Touch Reset to stop the test.
4. To continue testing, repeat steps 2 and 3.

See [Section 4.5.4 Event List](#) to clear events.

PLC Concentration / 4-20 mA Test

1. Select Analyzer
2. Select Point
3. Set the test level
4. Make sure the selected analyzer is out of monitor
5. Press Update/Reset

20 mA
100 % of Scale

Update
Reset

1-1 MONT	1-2 IDLE	1-3 MONT
N/A	N/A	N/A
N/A	N/A	N/A
Pt 1	Pt 5	
Pt 2	Pt 6	
Pt 3	Pt 7	
Pt 4	Pt 8	

Pump 1 GOOD ON Pump 2 GOOD OFF February 26, 2009 03:03:46 PM

No. Of Events: 4 Display Events: 1 - 4

Point 1-2-3 1-2-3 F
210 OPTICS NOISE
7/10/2008 11:12:38 AM

Point 1-1-2 1-1-2 2
60 000 ppb AsH3
7/10/2008 11:11:25 AM

Az1-1 M
Simulated Event
7/10/2008 11:10:57 AM

Ack Current	Ack ALL	Reset Current	Reset ALL
Alarm Test	Fault Test	Event History	Event Help

PLC Conc: 4-20 mA Test Authorized Service Main Screen Help

4.6.6 Security Access

Access to Vertex functions is granted according to a permission list which is stored in an HMI user account. See [Section 4.4.1 Log in and Log out](#) and [Section 4.4.2 Changing Password](#) for more information about HMI-level security. Only users authorized to access Security Setup may create or change user accounts. The system administrator assigns permission to Security Window and other protected functions by using the Security Setup menu.

The Vertex System is pre-programmed with two user accounts: “default” and “administrator”. The administrator password is “administrator”. Quotation marks should be included.

The default user account is pre-programmed to have full access. The default account “security access” bit and other bits must be turned off to make HMI-level security effective.

Note

The Security Setup function is only accessible if the user ID currently logged in has Security Setup bit set to Y (yes), or activated.

Several user accounts can be created with limited access rights to allow personnel to install Chemcassettes®. These accounts need not use the administrator password and thus cannot be used to deactivate monitoring for long periods.

Nonetheless, Chemcassette® installation requires monitoring interruption and human intervention. The Vertex can be set up to issue a fault if this intervention is not performed within a set time span. See [Set Timeout Values](#) in [Section 3.6 Configuration Utility](#) for more information.

To protect against errors by personnel who are only authorized to install Chemcassettes®, many of the permission bits must be set to “off” as shown in brown in Figure 4-47. The “Maintenance” bit must be set to “on”. Additionally, the administrator password should be set to something less obvious than “administrator”.

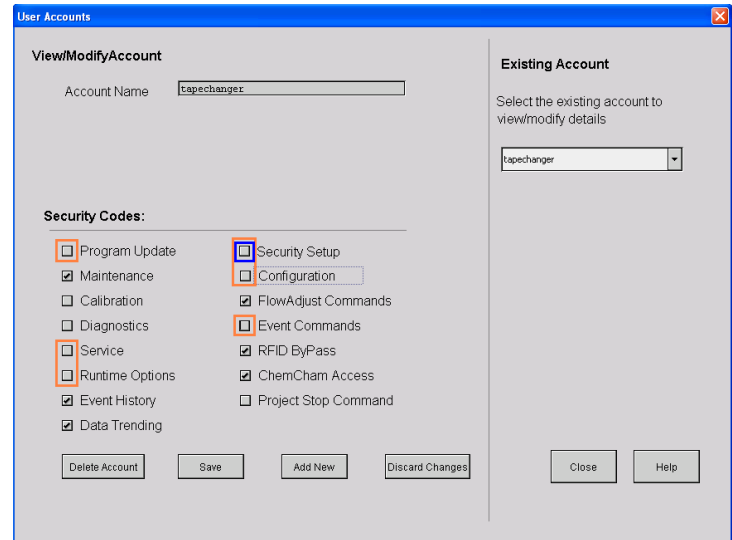

Figure 4-15. Modifying User Accounts

4.6.7 Configuration

Before the Vertex M System can begin monitoring, you must create a configuration profile. Use the Configuration menu to create a new configuration profile or modify an existing profile.

[Section 3.6 Configuration Utility](#) for the procedures on using the Configuration window.

4.7 OnScreen Keyboard

The Vertex M display provides an onscreen keyboard for data entry.



Keyboard

Keyboard Help Menu

4.7.1 Restore OnScreen Keyboard

If keyboard is hidden, restore it with the OnScreen Keyboard button from the Project Menu.

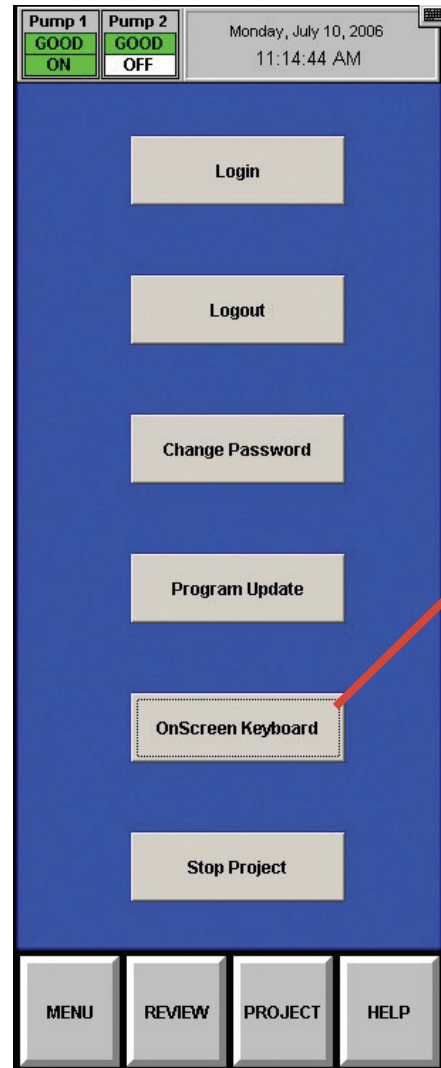

Keyboard Access Button

OnScreen Keyboard Button

5 Maintenance

5.1 Introduction

This section describes routine maintenance procedures including general monitor maintenance and Chemcassette® and pyrolyzer analyzer maintenance.

The Maintenance chapter includes:

- [5.3 Chemcassette® Analyzer Maintenance](#)
- [5.4 Replacing an Analyzer](#)
- [5.5 Remove and Replace Pyrolyzer Filters](#)
- [5.6 Remove and Install Pumps](#)
- [5.7 Remove and Install Power Supplies](#)
- [5.8 Clean the Touch Screen](#)
- [5.9 PLC Module Battery Backup Check](#)
- [5.10 File Maintenance](#)
- [5.11 Optics Cleaning](#)

Most of the procedures in this section use functions in the Maintenance Window. To reach the Maintenance Window, touch Main Screen, Menu and then Maintenance.

5.2 Maintenance Schedules

Perform maintenance following the schedule in Table 5-1. See [Appendix A Replacement and Consumable Items](#) for part numbers of maintenance items

Item	Schedule
Sample line filters (end of line)	3-6 months
Teflon Corrosive Filter Membrane (end of line)	1 month
Teflon Corrosive Filter	3 months
Cabinet filter (located in front of pump module)	3 months or as needed
Pump vane replacement	2 years operation per pump
Pump stem and o-ring	6 months
Proportional valve filter (inside analyzer)	1 year
Particulate Filters	3-6 months
Pyrolyzer Freon Filter	1 month or as needed
Acid Scrubber Filter	6 months
Alternate Pumps	6 months
Optics Cleaning	1 year or as needed
System File Maintenance	1 year or as needed

Table 5-1. Suggested Maintenance Schedule

5.3 Chemcassette® Analyzer Maintenance

This section describes maintenance and handling procedures for the Chemcassette® analyzer. Unless noted otherwise, these procedures apply to both the Universal Chemcassette® and the pyrolyzer model analyzers.

5.3.1 Remove and Replace Analyzer Particulate Filters

The Vertex M Chemcassette® analyzer uses various filters to protect the unit from particles and potentially damaging gases. Table 5-1 provides maintenance information about filters.

The Vertex M Analyzer houses filters in a filter magazine. Use the following procedure when replacing filters.

1. Set analyzer to idle in the Runtime Options window.
2. Touch Main Screen, Menu, Maintenance and then Change Filter.
3. Touch the Analyzer module number in the Analyzer selection keypad.
4. Touch Release Analyzer.
5. Slide analyzer out of cabinet until filter compartment is visible.

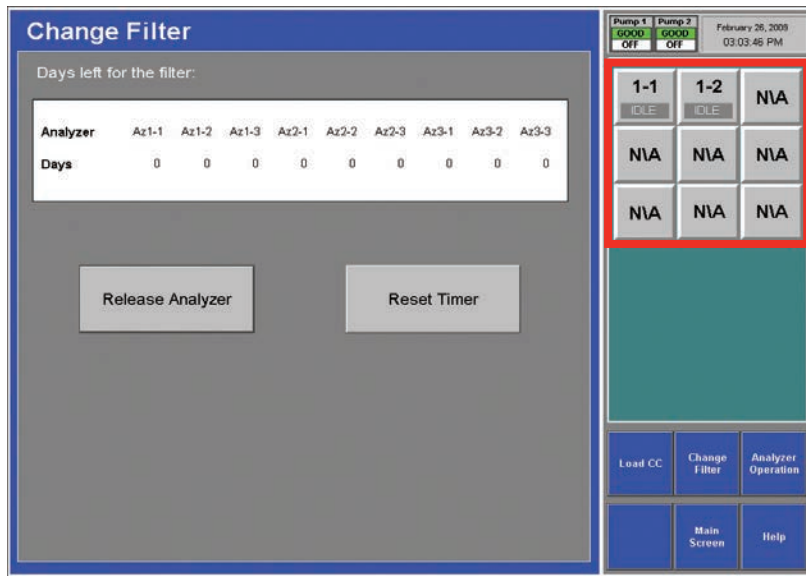

Analyzer Selection Keypad

5.3.2 Remove Filters



Figure 5-1. Analyzer Filter Door

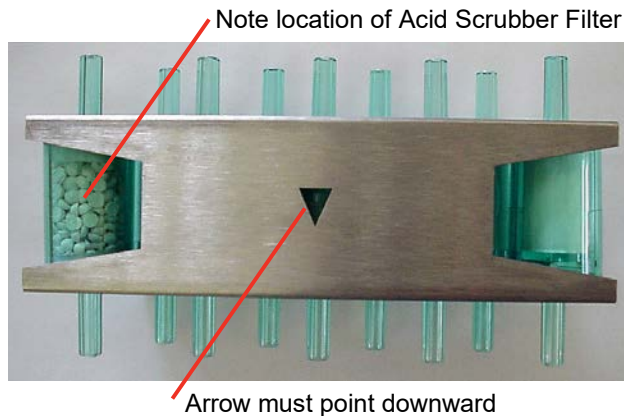

Figure 5-2. Vertex M Filter Magazine

1. Open filter compartment by rotating the latch downwards and pulling handle down until door is at a 90° angle to the analyzer.
2. Remove filter magazine by grasping the magazine with thumb and middle finger and pulling straight out.

Load Filters in Magazine

1. Remove and discard used filter elements.

2. Position new filters in magazine with the filter flow direction arrow pointing down. Press into place.

5.3.3 Replace Filters

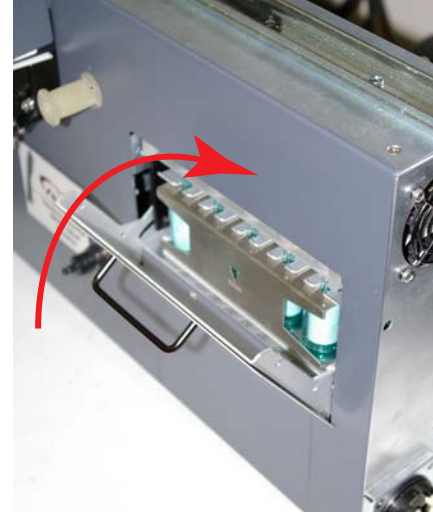

Figure 5-3. Analyzer Filter Door

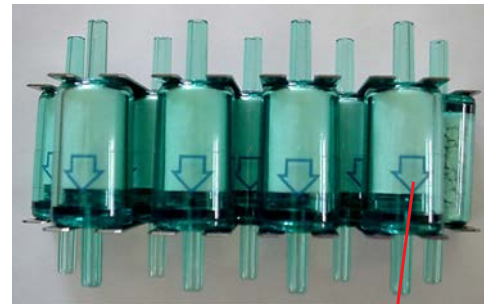

Figure 5-4. Vertex M Filters

1. Insert magazine into filter compartment.
2. Note orientation of arrow on side of magazine.
3. Close compartment door.

Return to Service

1. Press Reset Timer button on Change Filter screen.
2. Push analyzer into cabinet.
3. Return analyzer to monitor mode in Runtime Options window.
5. Position leading alignment mark on Chemcassette® tape under front edge of optic head.
6. Touch the NEXT button to verify optics. The tape advances as the Vertex M verifies the optics.
7. Push the analyzer into the cabinet.

5.3.4 Change Chemcassette® Tape

Change the Vertex M Chemcassette® tape for any of the following reasons:

- Scheduled end-of-tape service
- Low Chemcassette® warning (fault 102)
- Chemcassette® has expired (fault 109)
- End of Chemcassette® (fault 203)
- Transport error

Preparation

1. Reset End of Chemcassette® event if present.
2. Touch Main Screen, Menu and then Maintenance.
3. Touch the module number in the Maintenance window.
4. Touch Load CC. Follow the on-screen instructions which will guide you through the following sequence.

Change Chemcassette® Tape

1. Pull analyzer out of cabinet.
2. Remove the old Chemcassette®.
3. Install new tape. Verify the RFID tag is aligned with the RF sensor.
Touch the NEXT button to read RF sensor.
4. Thread tape leader.

5.4 Replacing an Analyzer

The Vertex M rack is designed for quick replacement of major components. You may replace both the Chemcassette® and pyrolyzer analyzers while other analyzers continue to monitor.

5.4.1 Disconnecting Cables

In steps 4 and 5 of the sequence that follows, you will need to disconnect the circular tubing harness and four electrical cables from the back of the analyzer. You need to reach around to the back of the analyzer as shown in this photo. In disconnecting or reconnecting the harness and cables, note the following:



ChemCam USB Connection
(Optional)

Analyzer Communications
(reconnect this cable first)

Analyzer 24V
Power Supply

To disconnect, depress the
lock tab on the power connector
and pull to release

Multi-Function
Connector

NOTE:

Connection secures by slide latch.
Push up to open, down to close.

Circular Tubing Harness

To disconnect, rotate the red tab
on the tubing connector to the
open position and pull the connector off

To reconnect, align the ports on the
connector, seat the connector fully then
rotate the red tab to "lock".

Cable Carrier

5.4.2 Remove Analyzer

1. Set analyzer to idle in the Runtime Options window.
Touch Main Screen, Menu, Maintenance and then Analyzer Operation.
Select the analyzer which you will replace. Touch Release Analyzer.
2. Open the front door and turn off power for the analyzer (and pyrolyzer switch if you are replacing a Pyrolyzer).
3. Pull analyzer out of cabinet. Locks on the slides limit the analyzer travel.
4. Reach behind analyzer and remove four electrical cables.
5. Unlock and remove tubing harness.
6. Unlatch the slides.
7. Support the analyzer and remove it from the slides.

5.4.3 Install Analyzers

1. Reach into the slot and position cables out of the way.
2. Place analyzer on slides. Push in until locks engage.
3. Slide Analyzer out until fully extended.
4. Reach behind the analyzer; connect and lock the tubing harness.

Note:

When reconnecting the analyzer, connect the Analyzer Communications cable to the analyzer first.

5. Connect the Analyzer Communications, 24V Power Supply, Multifunction Connector and ChemCam cables.
6. Carefully push analyzer partially into the cabinet and then pull out to verify all cables move freely and the slides lock. Repeat in and out action to loosen slide. Push analyzer into cabinet.

Return to Service

1. Open the front door and turn analyzer power switch (and pyrolyzer power switch if necessary) on.
2. Re-install Configuration Profile.
3. Install Chemcassette®.
4. Return analyzer to monitor mode in Runtime Options Menu.

5.5 Remove and Replace Pyrolyzer Filters

5.5.1 Remove Filters

The pyrolyzer version of the Chemcassette® detects nitrogen trifluoride by “cracking” or breaking it down with high temperatures. Heating nitrogen trifluoride converts it to hydrogen fluoride which the Vertex M pyrolyzer detects with a standard mineral acid Chemcassette®. The pyrolyzer heaters and associated control circuits are maintenance items not found in the Universal Chemcassette® analyzer.

This section describes maintenance procedures unique to the pyrolyzer analyzer.

There are eight filters in the pyrolyzer not found on the Universal Chemcassette® analyzer. The additional filters are filled with charcoal to remove Freon and other similar compounds from the sample gas before it is “cracked” in the pyrolyzer. The acid scrubber and particulate filters are identical to the standard Vertex M Chemcassette® filters.

1. Set analyzer to idle in the Runtime Options window.
2. Touch Main Screen, Menu, Maintenance and then Analyzer Operation.
3. Touch the module number in the Maintenance window.
4. Touch Release Analyzer.
5. Slide Analyzer out until fully extended.

Freon filters are located on the left side of the analyzer.



Figure 5-5. Pyrolyzer Filter Door



Figure 5-6. Vertex M Pyrolyzer Filter

1. Open filter compartment by pulling handle down until door is at a 90° angle to the analyzer.
2. Remove filter magazine by grasping the magazine with thumb and middle finger and pulling straight out.

Load Filters in Magazine

1. Remove and discard used filter elements.
2. Position new filters in magazine such that the long nipples are up and press into place. Note direction of flow arrows.

5.5.2 Replace Filters



1. Note orientation of arrow on side of magazine.
2. Insert magazine into filter compartment.
3. Close compartment door

Return to Service

1. Push analyzer into cabinet.
2. Return analyzer to monitor mode in Runtime Options window.

5.6 Remove and Install Pumps

The Vertex M System includes two vacuum pumps. One pump operates while the other is idle. You may replace a defective pump while the other pump continues to operate.

Note:

You may replace a pump only when the system places it in standby. Do not replace an operating pump.

To equalize wear on the pumps, alternate the operating pump every 6 months.

To change operating pump without manually stopping monitoring touch the Main Screen, Menu, Service, Authorized Service buttons and then the Pump Alternate button.

The operating pump indicator is green or yellow; the indicator for the pump in idle is white.

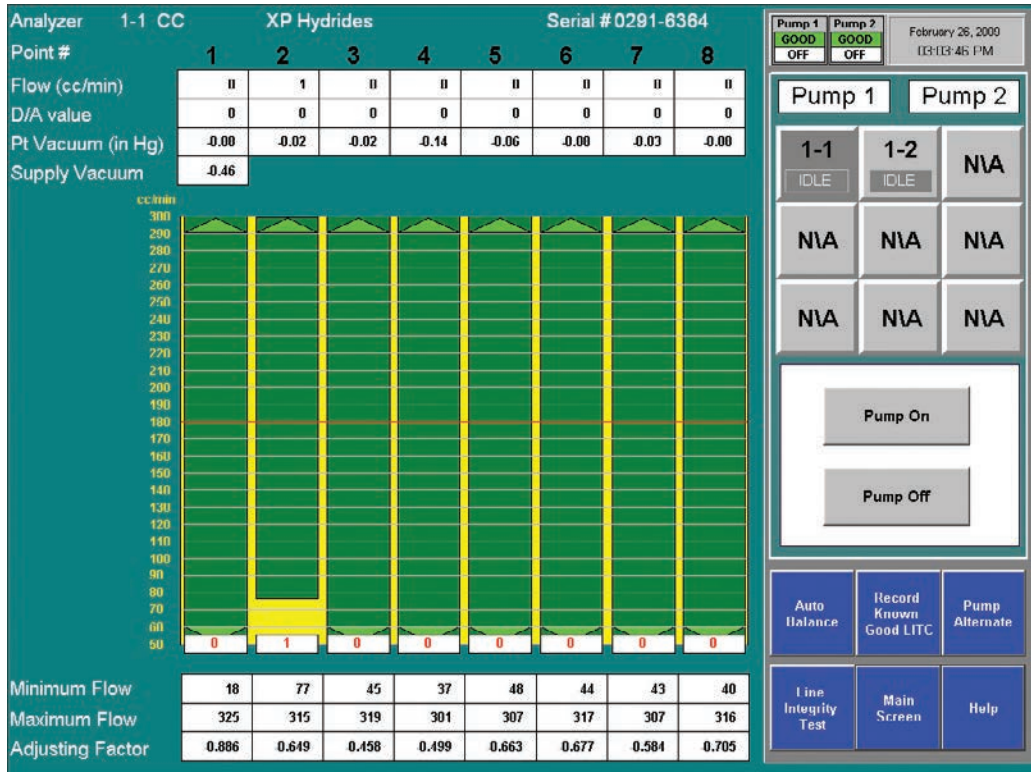

5.6.1 Remove Pump

1. Open lower cabinet door and remove filter.
2. Turn thumbscrews counterclockwise to release and open pump enclosure door.
3. Push slide plate to disengage.



Then pull fittings up to remove from pump.

4. Pull up on slide-release button.



5. Slide pump out of enclosure.



CAUTION

Operating the system with the exhaust fitting improperly installed or with one of the pumps removed can result in exposure to toxic gases from remote sampling areas.

To prevent exposure:

- Insert ½ Plug (P/N 0235-0168) into the fittings of the pump that was removed for service.
- Inspect the pump fittings to ensure that the surface is free from score marks and scratches that could compromise the O-ring seal.
- Fully seat the removable fitting on the pump after installation.
- On pumps, verify that the slide plate button extends and mechanically secures the fitting.

With the system running, verify the leak integrity with a small amount of leak test fluid.

CAUTION

The pump may be hot. To avoid burns, allow it to cool or wear protective clothing before handling it.

5.6.2 Install New Pump

1. Slide pump assembly into enclosure.



2. Push pump completely into enclosure until the release button locks into the bottom of the enclosure.



4. Push on slideplate to re-install on to fitting

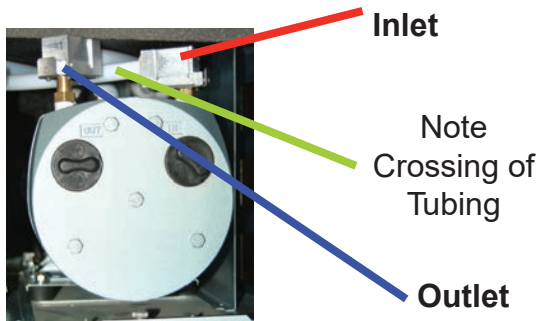

3. Close and fasten the pump enclosure door, install filter, and close lower cabinet door.



WARNING

Adjacent pump may be hot. To avoid burns, allow to cool or wear protective clothing before handling either pump.

5.7 Remove and Install Power Supplies

5.7.1 Remove Supply

Two replaceable modules provide power for the Vertex M System. A fully populated Vertex M will operate with one supply. You may replace the defective supply while the system continues to monitor.

Preparation

1. Open front door.
2. Identify inoperative power supply.
3. Turn locking knob counter-clockwise to disengage catch.
4. Firmly pull power supply to remove from housing.

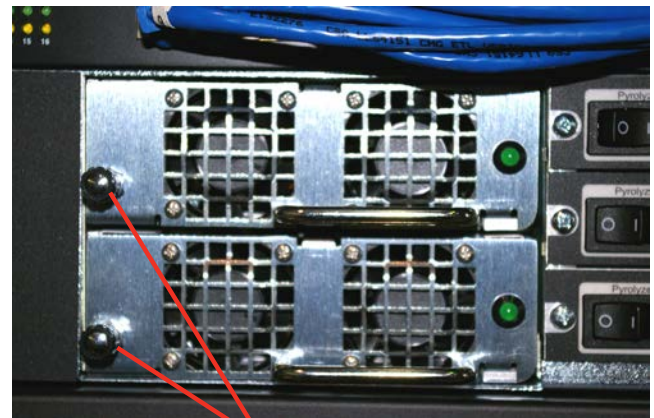

Locking knob

5.7.2 Replace Supply

1. Insert new supply in housing.
2. Verify handle is on the left of the power supply.
3. Seat firmly into place.
4. Verify latch or locking knob has locked supply in the housing.
5. Tug on handle to verify supply is firmly seated.

5.8 Clean the Touch Screen

Clean the touch screen display with a lightly moistened towel. Do not spray cleaner directly onto the glass. Excess liquid will run down the screen and interfere with operation.

Reference your touch monitor manual for any additional information.

5.9 PLC Module Battery Backup Check

1. For status of battery locate indicator as shown in photo on the left.
2. If battery indicator is illuminated the battery has failed. Contact HA Service for corrective action.

Note:

Some serial communication cards (located in slot 2) do not have battery backup.

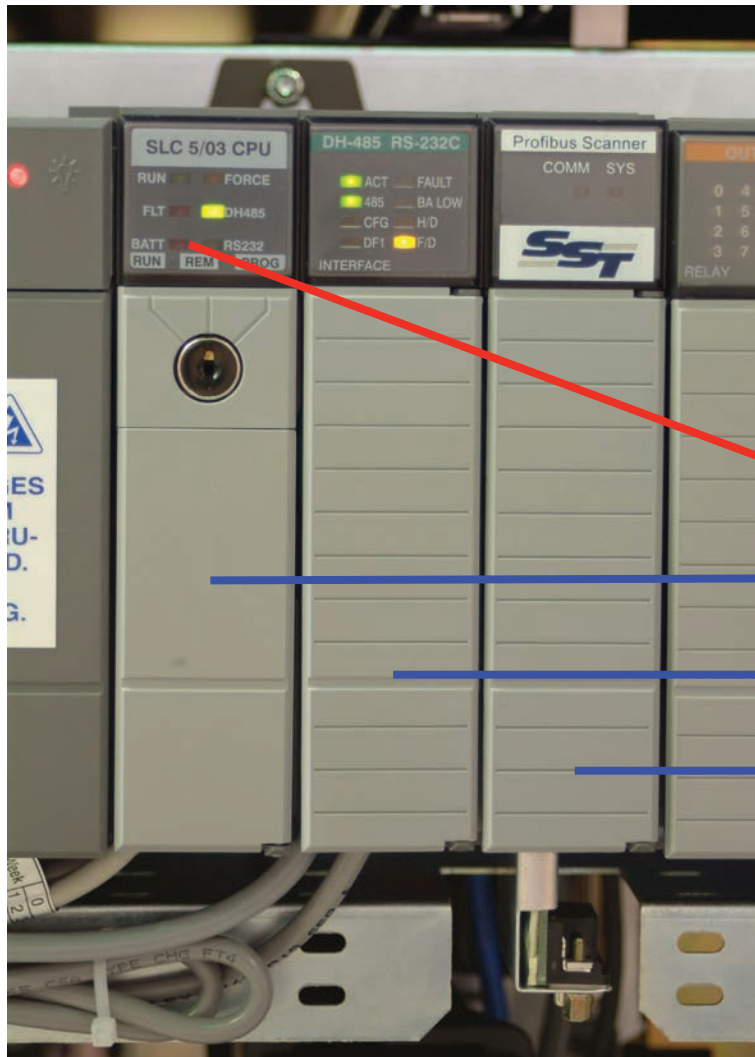

Battery indicator

Slot 0 = CPU

Slot 1 = KE Module

Slot 2 = Serial Communications
Option Module

5.10 File Maintenance

This section describes the procedure for making backup copies of Vertex M database files:

1. Touch Project then Stop Project to stop the Vertex M application. You must have appropriate access rights to perform this step.
2. Make an offline backup copy of the files listed below in _.

The following files on the Vertex M should be copied to either a backup location on your local area network, removable media or a CD-R/CD-RW disk.

Note:

Some backup media may change the files to “read only” and may require an additional step of changing the “Attributes” within the file properties to make them usable.

Empty databases for the Event, Concentration and ChemCam databases can be found in the Databases folder on the Vertex M Technical Manual CD.

File Name	Purpose	Location
*.za_Vt	Configuration Profiles	C:\HMI\IP_Util
CM72Data.dsn	ODBC Datasource for Event Database	C:\HMI
ConcData.dsn	ODBC Datasource for Concentration Database	C:\HMI
ChemCam.dsn	ODBC Datasource for ChemCam Database	C:\HMI
CM72.mdb *	Event database	C:\HMI
CM72Conc.mdb*	Concentration Database	C:\HMI
ChemCam.mdb *	ChemCam Database	C:\HMI\ ChemCam

* Required if stored locally on the Vertex M System

NOTE: Database files are size limited to a maximum of 2Gb.

Table 5-2. File Locations

5.11 Optics Cleaning

Clean Chemcassette® optics annually or whenever optics verification error occurs.

Required equipment:

- Compressed air

Note:

Do not use “canned air” near Pyrolyzer gas based detectors, the halogenated gasses may trigger alarms. Instead, use N₂ or a compressed source that is free of oils and contaminants.

- Open the Optics Block Gate

- Remove the Chemcassette®
- Open the Vertex M side panel
- Remove tubing (shown in photo) one at the time and blow out with compressed air.
- Re-secure side panel and reload Chemcassette®

Note:

Remove and clean one port at a time to insure proper orientation of tubing. Do not remove the capillary tubing (microtubes).

CAUTION

Failure to replace and retighten hardware after service can adversely affect monitor performance and electromagnetic radiation compliance (EMC). Make certain all fasteners are reinstalled and firmly fastened.

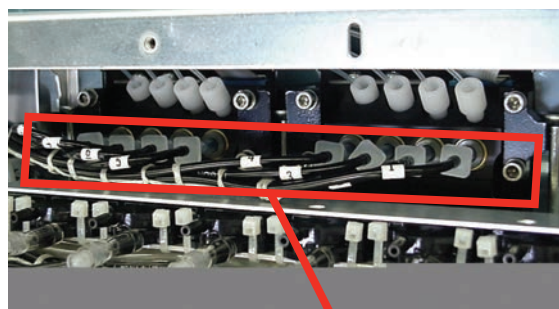

Remove these tubes one at a time for cleaning

6 Troubleshooting

6.1 Introduction

This chapter helps you determine the source of Vertex M System fault or failure and provides you with a corrective action. There are three general indications that service or maintenance is necessary:

- General failure to operate properly. See [Section 6.2 General System Problems](#).
- Maintenance faults. See [Section 6.3 Maintenance Faults](#).
- Instrument faults. See [Section 6.4 Instrument Faults](#).

Maintenance and instrument faults are Vertex M System self-diagnostic messages. They alert you to operation abnormalities by displaying a message with a brief description. The Vertex M System also stores the faults in the event history list.

Also included in this chapter are information events which are records of non-fault activities that may aid in troubleshooting. See [Section 6.5 Information Events](#).

Information events include:

- Maintenance activities
- Alarm simulations
- User log in and log out
- Configuration changes

If a fault or failure does not appear in the troubleshooting chart, or if you require further assistance, call Honeywell Analytics Service. Provide the maintenance or instrument fault code number when calling.

In the event of a DAq failure See [Section If additional or replacement Vertex M Analyzers are purchased without specifying the LIT option, no faults will be generated for the lack of the option in the new analyzer. However, an “INFO” message will be logged in the Event History each time the LIT option is invoked. Existing analyzers](#)

[configured for LIT will be unaffected.](#)

6.2 General System Problems

This section applies to problems and solutions that are not reported by the Vertex M software.

LCD Display		
Symptom	Problem	Recovery
No display	Faulty connection at DAq	Check connection at SVGA connector on back of DAq
	Faulty connection at display	Check connection on back of display
	No power to display	Check power cable between power distribution box and display power supply
	Screen saver or Energy Star feature enabled	Touch the LCD screen Press a key on the keyboard Disable screen saver and Energy Star setting in Windows control panel
Display distorted or wrong size	Incorrect settings in Windows control panel	Use Windows control panel to set display to 1028 x 768 display
"No signal" on screen	Data acquisition computer not operational	Turn on data acquisition computer power switch
Touchscreen		
Symptom	Problem	Recovery
No response from touch screen	Faulty connection at DAq	Check cable connection at serial port
	Faulty connection at display	Check cable connection on back of display
	COM1 not assigned	Check assignment for COM1 in Windows control panel
	Incorrect touch screen driver settings	Restore setting in ELO Windows control panel
Data Acquisition Computer		
Symptom	Problem	Recovery
No green power light	Power switch	Turn power switch on
		Turn circuit breaker on
		Check power cable
Keyboard and Touchpad		
Symptom	Problem	Recovery
"Optional Keyboard not detected" message	Keyboard only recognized by Windows at start up	Plug in keyboard and restart system
Single key not responding	Defective keyboard	Replace keyboard
Keyboard not responding with any key	Faulty connection	Check keyboard connection on back of data acquisition computer
	Defective keyboard	Replace keyboard
Touch pad not responding	Faulty connection	Check mouse connection on back of data acquisition computer
	Defective touch pad	Replace keyboard

Communications		
Symptom	Problem	Recovery
Vertex M not appearing on network	Incorrect network connection	Check cable connection to Ethernet port Note: Use only the Ethernet connection on the back of the data acquisition computer. The Ethernet hub in the Vertex M System is only for Vertex M internal use.
	Windows not configured for network	Use Windows Network control panel to configure network Vertex M computer name is Vertex_293-xxxx Default workgroup is "Workgroup"
ChemCam		
Symptom	Problem	Recovery
No image from one or more ChemCam	Defective camera	Contact Honeywell Analytics
	Defective USB port	Use any other spare USB port
Poor image quality	Camera settings are incorrect or illumination LED has failed	Contact Honeywell Analytics

6.3 Maintenance Faults

A maintenance fault indicates the Vertex M System requires attention but is continuing to monitor. When a maintenance fault occurs, the following actions take place within the Vertex M System:

- The LED indicator flashes yellow on the analyzer with the fault. See [Table 6-1. Analyzer Status LEDs.](#)
- A yellow fault indicator appears on the main screen
- The event list and event history are updated
- Maintenance Fault relays associated with this analyzer will activate

Event Number	Event List Desc. (Short)	Event History Description	Data Field	Problem	Possible Cause	Recovery
101	FLOW ADJ ERR LOW	Low Flow After Adjustment	cc/min. of error	Point Flow reading can not reach 150 cc/min.		Verify range of valve by performing Auto Balance calibration Identify possible cause if maximum flow is below 240 cc/min.
					Condensation	Check internal lines for moisture Purge as required
					Internal proportional valve filter clogged	Replace particulate filter at manifold
					Proportional valve failure	Replace Valve
				Supply vacuum insufficient (less than 7 in. Hg)	Plug pneumatic connector in unused slots Exhaust tubing restricted Service or switch pumps	
			Excessive point vacuum	Sample line restricted End of line filter plugged Too many analyzers sharing one sample line Sample Line too long I.D. too small Poor gate seal	Clear restriction Replace filter Reduce number of analyzers on same Line Correct sample line issue Contact Honeywell Analytics Service	
102	LOW CC WARNING	Chemcassette Low	Days Remaining	Chemcassette counter decremented to less than 120 windows	Less than one day remains on Chemcassette	Replace Chemcassette

Event Number	Event List Desc. (Short)	Event History Description	Data Field	Problem	Possible Cause	Recovery
103	TIMEOUT IDLE	Timeout Of Monitor	0.0	Analyzer in IDLE, LOAD CC, FLOW	Out of Monitor time limit has been exceeded	Press RESET to reinitialize timer.
					User error	Enter Monitor using Runtime Options Return analyzer to Monitor Mode
					Time limit too short	Change time limit in Configuration Profile
104	TIMEOUT PNT DIS	Timeout Run-time Point Disable	0.0	Operator error	Point disabled longer than time limit setting in the Configuration Profile	Press RESET to reinitialize timer Restore point to Monitor Mode
					Time limit too short	Change time limit in Configuration Profile
105	TIMEOUT ALM DIS	Timeout Run-time Alarm Disable	0.0	Operator error	Point disabled longer than time limit setting in the Configuration Profile	Press RESET to reinitialize timer Restore point to Monitor Mode
					Time limit too short	Change time limit in Configuration Profile
106	POS PNT PRESSURE	Positive Point Pressure	Pressure in. Hg	Positive pressure between sampling location and monitor	Point pressure above atmospheric pressure while in idle	Relieve/reduce pressure
				Transducer error	Calibration error	Contact Honeywell Analytics Service
					Defective sensor	Contact Honeywell Analytics Service
					Offset incorrect	Contact Honeywell Analytics Service
108	FLOW ADJ ERR HI	High Flow After Adjustment	cc/min.	Flow cannot be adjusted below 210 cc/min.	Debris in proportional valve	Verify range of valve Perform Auto Balance to clear debris
					Debris or defective valve Proportional valve held open	Replace with 0235-1279
109	CC EXPIRED	Chemcassette Passed Expiration Date	0.0	Operator error	Chemcassette installed past its expiration date	Replace Chemcassette
				Chemcassette expired	Expiration date reached	Replace Chemcassette
110	INVALID CC	Invalid Chemcassette		CC Tag does not match profile or is unreadable	Bad configuration or corrupted RFID	Check gas configuration Replace Chemcassette

Event Number	Event List Desc. (Short)	Event History Description	Data Field	Problem	Possible Cause	Recovery
111	DACS COM FAIL	No Communication from PC To Az	0.0	Ethernet communications	Communications to DACS interrupted longer than 20 seconds	Check Ethernet cable at rear of analyzer Check Ethernet hub connection and operation Check Ethernet connection to DACS Restart DACS to clear OPC driver problem
112	SWAPPED BAD PUMP	Single pump failed and swapped	Number of bad pump - 1 or 2	Pump swap has occurred because vacuum levels fell below 6 in. Hg	Pump failure	Rebuild/Replace non-operating pump
					Unused slots not plugged	Install 1295-0404 connector plug on unused slot
					Large 0.018 in transport flow orifices installed	Replace all orifices with 0.015 in orifices (p/n 1290K0009 per Analyzer)
					Check valve on inactive pump leaking	Replace check valve
						Contact Honeywell Analytics Service
113	OPTICS MAINT	Optics Drive High-Cleaning Req	Drive	LED drive required to set zero too high		Clean optics Contact Honeywell Analytics Service
				Tape leader installed improperly	Leader not centered (Pts 1 or 5 error)	Reload Chemcassette and recalibrate using leader
					Autozero performed while tape on light or dark gray portion of leader	Reload Chemcassette and recalibrate using leader
					Dirt in optics	Clean optics block
114	POINT VAC ERR	Excessive Point Vacuum	in. Hg	Sample vacuum is greater than 5 in. Hg vacuum for longer than 5 seconds	End of line filter clogged	Replace clogged end of line filter
					Sample line kinked	Isolate by disconnecting possible crimped sample line
					Maximum line length exceeded on a shared sample line	Isolate shared sample line Review limits number of analyzers, tubing ID vs. Length (See Table B.2)
					Crimped tube in cable carrier	Identify crimps in tubing harness by checking pressure with analyzer closed vs. open

Event Number	Event List Desc. (Short)	Event History Description	Data Field	Problem	Possible Cause	Recovery
115	AZ SW DIAGNOSTIC	Az Software Diagnostic	0.0	Analyzer failed to enter monitor after pump swap	Control related fault is issued because of an improper control response from another analyzer	Verify all analyzers enter monitor mode successfully
116	PUMP OVER-TEMP	Pump Over Temperature	0.0	Pump module Temperature exceeded	Clogged Filter	Replace air filter
					Fan Failure	Check fans in pump module
					Line voltage less than 208 VAC	Verify main line voltage
117	PUMP EXHAUST HI	High Exhaust Pressure	0.0	Exhaust Manifold pressure greater than 9 in. Hg (4.4 PSI)	Kinked exhaust	Check exhaust tubing for kinks or restrictions
					Exhaust tubing length exceeds 50 ft. (15 m.)	Reroute to reduce length or change to a larger diameter sample line
118	POWER SUPPLY	Power Supply Fail/missing	0.0	Redundant supply not available	Failure	Replace with supply 0060-0020
119	BAD OPTICS TEMP	Optics Temperature Out Of Range	Sum of error codes 1.0 to 64.0	1.0: Front block reads <0°C	Cold Environment	Relocate Vertex M
				2.0: Front block reads >60°C	Electronic problem	Replace front optics block
				4.0: Front block reads 45-60°C	Cooling air failure	Change air filter, replace fan
					Hot environment	Relocate Vertex M
				8.0: Rear block reads <0°	Cold environment	Relocate Vertex M
				16.0: Rear block reads >60°	Electronic problem	Replace rear optics block
				32.0: Rear block reads 45-60°C	Cooling air failure	Change air filter, replace fan
					Hot environment	Relocate Vertex M
64.0: Two blocks disagree by 10°C	Electronic problem	Observe Log1 output to identify defective block, replace				
120	CHANGE FILTERS	Filter Timer Expired	0.0	Filter time in configuration profile elapsed	Maintenance reminder, no malfunction	Change filter and reset timer
121	CABLE PROBLEM	Multifunction Cable Problem	varies	DB-25 disconnected at rear of some analyzer		Connect cable

Event Number	Event List Desc. (Short)	Event History Description	Data Field	Problem	Possible Cause	Recovery
122	LIT NO REF	LIT has no reference	bitmask of points skipped, 1-255	Analyzer has no record or correct cracking pressure	Point was disabled in configuration when previous LIT characterization was performed	Perform characterization or disable LIT test for point in configuration
123	LIT CHAR FAIL	LIT Characterization failed	Observed cracking pressure (in Hg)	Inadequate cracking pressure measured during characterization	Check valve not installed	Install check valve or disable LIT test in config
					Sample tubing cut or leaking	Replace tubing
124	LINE FAIL	Sample line leak detected	Observed cracking pressure (in Hg)	Inadequate cracking pressure measured during the monitoring by the optional Line Integrity Test	Sample tubing cut or leaking	Replace tubing
					Ambient pressure at sampled point differs from Vertex M exhaust by more than 0.3 in Hg (1 KPa)	Revise installation
					Check valve not seating	Replace check valve
125	LIT COORDINATION	Coordination failure during LIT	Error code 1.0 - 6.0	LIT test not performed because analyzers could not coordinate the test	Some analyzers were in LOADCC or other special mode	None needed
					Software anomaly	If repeated, notify Honeywell Analytics Service
126	OPTICS DEBRIS	Possible debris in optics block	Diagnostic Counter	Optics signal has been erratic on at least 3 windows	Debris in optics block	Clean optics block as shown in Section 5.11

Event Number	Event List Desc. (Short)	Event History Description	Data Field	Problem	Possible Cause	Recovery
127	AUTOBALANCE FAIL	Flow Autobalance Failed	No. of Failed Attempts	Detailed failures can be determined by the data from the accompanying info event(s) by using the table below.		
				11 to 23	Adjusting factor out of range	Anomaly encountered
			Faulty valve			Contact HA Service
			30	Adjusting factor varies between 3 spots	Anomaly encountered	Repeat Auto balance
					Other	Contact HA Service
			41 to 43	Inadequate flow	Insufficient vacuum (<8 in Hg)	See recovery for Fault 112
					Excessive pressure drop in tubing	See recovery for Fault 114
					Faulty valve	Contact HA Service
51 to 53	Excessive minimum flow	Debris in valve	Repeat Auto balance			
		Faulty valve	Contact HA Service			
128*	WINDOW ZERO RESET	Window Zero Reset	Diagnostic Counter	Same as Fault 126	Same as Fault 126	Same as Fault 126
129	ACCEL. CC USAGE	Accelerated Chemcassette Usage	Time since last Chemcassette advance	Chemcassette advancing more often than expected	Low level background gas below lower detectable limit	Locate source of background gas
130	VR FAILED	Virtual Reference Test Failed	Sample Counter	Tape reflectance differs slightly between windows	Old tape	Contact HA Service if this occurs frequently
					Ambient gas concentration	

*Dependent on the setting in the Configuration menu.

6.4 Instrument Faults

An instrument fault indicates a loss of monitoring on one or more points. When an instrument fault occurs, the following actions take place within the Vertex M System:

The LED indicator flashes yellow on the analyzer with the fault. See [Table 6-1. Analyzer Status LEDs](#).

- A yellow fault indicator appears on the main screen
- The fault is entered into the event list and event history
- Instrument Fault relays associated with this analyzer will activate

Event Number	Event List Desc. (Short)	Event History Description	Data Field	Problem	Possible Cause	Recovery
202	HIGH BACKGROUND	High Background	Optical signal counts	Bad Chemcassette	Chemcassette discolored	Check optics values in event history
					Moisture on Chemcassette	Check optics values for last Chemcassette load in event history
				Chemcassette tracking/installation error	Errors occurring on points 1 and 5 or 4 and 8 only indicate a tracking problem	Check guide position Reload Chemcassette using maintenance analyzer operation
				Optics block dirty	Dust	Clean optics
203	END OF CC	End Of Chemcassette	0.0	Insufficient Chemcassette motion detected	End of Chemcassette	Replace Chemcassette
					Chemcassette broken	Rethread Chemcassette (See Section 5.3.4 Change Chemcassette® Tape)
					Faulty tape encoder	Service analyzer
					Advance motor failure	Service analyzer
					Gate opening insufficient	Service analyzer
205	FAIL WR HW CONF	Failure Writing Hardware Config		Failure writing hardware configuration	Non-volatile memory failure in analyzer CPU	Service or replace analyzer
206	FAIL RD HW CONF	Failure Reading Hardware Config		Failure reading hardware configuration	Non-volatile memory failure in analyzer CPU	Service or replace analyzer
207	PYRO FAILURE	Pyrolyzer Failure	Internal Temp	Pyrolyzer failure	Heater element Fuse failure Thermocouple Failure	Service or replace analyzer
208	PYRO OVERTEMP	Skin Over-Temperature	1 or 2 Pyrolyzer number	Pyrolyzer skin temperature greater than 105°C	Fan failure in analyzer	Replace fan
					Sensor failure	Replace sensor

Event Number	Event List Desc. (Short)	Event History Description	Data Field	Problem	Possible Cause	Recovery
209	GATE TIMEOUT	Gate Motor Timeout	0.0	Gate motor timeout 7 seconds	Gate position sensor not activated before timeout	Check motor operation using Maintenance/ Analyzer Operations/ Open Gate or Close Gate
					Motor does not operate	Check motor connections to sensor interface PCB in analyzer
					Bad sensor or cable	Check sensor connection on PCB Contact Honeywell service
210	OPTICS NOISE	Optics Noise	Counts	Optics Noise	Poor grounding	Contact Honeywell service
					Optics block cover loose	Retighten or reinstall as required
211	OPTICS FAILURE	Optics Failure	Counts	Count values from optics reading exceeded limits	Cable disconnected	Check cable Contact Honeywell service
					Optics board defective	Contact Honeywell service
					Sensor interface defective	Contact Honeywell service
					Optics LED not properly calibrated	Perform Load CC Operation to recalibrate
212	GAS TABLE ERROR	Gas Table Error		Gas table corrupt or missing	No configuration loaded	Reinstall Configuration Profile
215	HIGH PYRO FLOW	High Pyrolyzer Flow	flow cc/min.	Proportional valve failure	Debris in valve	Replace valve
				Improperly characterized proportional valve	Change in flow system configuration	Perform Auto Balance operation
				Static flow reading	Transducer failure	Service or replace analyzer
216	OPTICS DRIVE LOW	Optics Drive Low	Drive counts	Drive value below allowable threshold	Problem in optics block or sensor interface electronics	Service or replace analyzer
217	OPTICS DRIVE HI	Optics Drive High	Drive counts	Drive value above allowable threshold	Problem in optics block or sensor interface electronics	Service or replace analyzer

Event Number	Event List Desc. (Short)	Event History Description	Data Field	Problem	Possible Cause	Recovery
218	OPTICS READING HI	Optics Reading High	Optics counts	Drive value above allowable threshold	Problem in optics block or sensor interface electronics	Service or replace analyzer
219	DOUBLE PUMP FAIL	Double Pump Failure	Number of last pump failed - 1 or 2	Pump unable to produce 6 in Hg vacuum while Fault 112 active.	See causes for Fault 112	See recoveries for Fault 112
					Circuit breaker tripped	Circuit breakers are self resetting. Contact Honeywell Service
220	LOSS OF FLOW	Loss of Flow	cc/min.	Flow less than 180 cc/min.		Perform Auto Balance after any service
				On point 1 or 1 and 5 only	Tape tracking problem	Reload Chemcassette
				Obstruction	Condensation in system	Purge internal lines
					Internal valve filter	Replace filter
					Proportional valve	Replace valve
					Clogged micro tube	Replace tube Note: Calibration required
					Clogged freon filter (Pyrolyzer)	Replace freon filter
				Pneumatic integrity compromised	Gate not fully closing	Gate adjustment loose, pivot binding
Optics block loose	Tighten optics block fasteners					
221	AZ SW DIAGNOSTIC	Az Software Diagnostic	0.0	Pump control conflict between one or more analyzers	Power cycled at random on multiple analyzers operating alternate pumps	Cycle power to resynchronize system
223	AZ SW DIAGNOSTIC	Az Software Diagnostic	0.0	Pump control conflict between one or more analyzers	Power cycled at random on multiple analyzers operating alternate pumps	Cycle power to resynchronize system
225	INVALID PT PRES	Point Pressure Out Of Range	in. Hg	Sample pressure out of range	Miscalibrated sensor board or defective transducer	Replace Analyzer
					Positive pressure at sample location	Determine cause of pressure
226	INVALID SUP PRES	Supply Pressure Out Of Range	in. Hg	Manifold pressure out of range	Miscalibrated sensor board or defective transducer	Replace Analyzer

Event Number	Event List Desc. (Short)	Event History Description	Data Field	Problem	Possible Cause	Recovery
228	NO PYRO MAINS PWR	No Pyrolyzer Mains Power	1	No mains power at points 5-8	Internal thermal fuse opened	Check cooling fan, replace thermal fuse
			2	No mains power at points 1-4		
			3	No mains power at all 8 points	Pyro mains switch not on Circuit breaker tripped Power connector disconnected Defective transformer	Turn on pyro mains switch Breaker is self resetting Check connection on back of Analyzer Replace transformer
229	OPTICS CFG ERR	Invalid Optics Configuration	Error code	Microprocessor in optics block reports problem.	Chemleader read failed	Reread Chemleader. Cycle power to analyzer. Update software in optics block.
230	COM FAIL TO PLC	No Communication From PLC To Az	0.0	No communication from PLC	Communication has timed out to PLC	Cycle power to the analyzers and reload Configuration Profile Check FLT light on PLC
					Connection at rear of analyzer	Check 25-pin, multifunction cable at the rear of the analyzer
					Check cable connections to the PLC	Check cable connection at chassis from carrier
231	DRV ADJ FAIL	AUTO LED Adjustment Failed	Optics counts	LED adjustment failed	Tape incorrectly loaded	Reload and retry tape load
					Dirty optics block	Service or replace analyzer
					Bad optics PCB set	Service or replace analyzer
					Bad RFID tag	Load new Chemcassette
232	BAD Q-FACTOR	Q-Factor Out Of Range	Q-Factor	Q-Factor out of range	Chemcassette leader not tight or improperly positioned during white to light gray calibration	Reload Chemcassette
					Bad RFID tag	Load new Chemcassette
					Dirty optics block	Clean and recalibrate
					Bad optics PCB set	Service or replace analyzer

Event Number	Event List Desc. (Short)	Event History Description	Data Field	Problem	Possible Cause	Recovery
233	FAIL OPT VERIFY	Optics Verification Failed	Adj Cnts	Optics Verification Failed	Chemcassette leader not tight or improperly positioned during light gray to dark gray calibration	Reload Chemcassette
					Bad RFID tag	Load new Chemcassette
					Dirty optics block	Clean and recalibrate
					Bad optics PCB set	Service or replace analyzer
234	GRAY FAILED	Light Gray Read Failed	Optics Cnts	Optics values of this field were outside limits	Chemcassette leader not tight or improperly positioned during light gray to dark gray calibration	Reload Chemcassette
					Bad RFID tag	Load new Chemcassette
					Dirty optics block	Clean and recalibrate
					Bad optics PCB set	Service or replace analyzer
235	AZ SW VER WRONG	Analyzer software version mismatch	0	Software mismatch		Reload program to all analyzers Contact Honeywell service
237	AZ VACUUM LOW	Inadequate Analyzer Vacuum	Observed vacuum in in Hg	Individual analyzer observes inadequate vacuum, stops monitoring	Fault 219 has triggered.	Recover from Fault 219, then reset Fault 237
					Circular tubing harness disconnected	Connect circular tubing harness
					Tubing pinched	Correct tubing dress in cable carrier Contact Honeywell Service
238	OP SW MISMATCH	Optics block software mismatch.	0	The two optics blocks are not running the same software version.	Program update done incorrectly.	Reload program to both optics blocks.
239	OPTICS COMM FAIL	Optics block communication failure	Error code	Analyzer is not able to communicate with the optics block.	Cable disconnected. Software anomaly. Defective optics block.	Check the 14 pin cable connection on the sensor board. Cycle power to analyzer. Contact Honeywell service.
240	OPTICS REF FAIL	Optics reference limit exceeded	Reference value signal	The signal detected at the reference photodiode is out of range.	Degraded optics block.	Contact Honeywell service.

Event Number	Event List Desc. (Short)	Event History Description	Data Field	Problem	Possible Cause	Recovery
241	OPT REF ADJ TIMEOUT	Optics reference adjustment timeout	Error code	Optics block self-adjustment timeout.		Cycle power to analyzer. Contact Honeywell service.
270	COM AZ # # BROKEN	OPC To Az ## Communica-tions Broken		Analyzer not responding to OPC driver polling request	Analyzer powered down	Check switch on power module
					Ethernet cable not connected	Check Ethernet connection at the back of the analyzer Move cable to different port on Ethernet hub
301	PLC-COM BROKEN	PLC-Com Broken		PLC fails to respond to DAq communication	Cable connection problem	Check serial communications on DAq COM2 Check serial cable on PLC 1747-KE See Section 1.2.7 Data Acquisition Computer (rear) See Section 1.2.9 Main PLC
					Loss of PLC power	Check power connections for PLC
302	AZ-BAD PROF ID	AZ has wrong profile loaded		Profile ID in analyzer does not match current configuration in use	Configuration not properly loaded	Reinstall current Configuration Profile
303	PLC-BAD PROF ID	PLC Has Wrong Profile loaded		Profile ID in PLC does not match current configuration in use	Configuration not properly loaded	Reinstall current Configuration Profile
304	PLC SYSTEM FAULT	PLC System Fault	PLC Error Code	A fault has occurred on the PLC that prevents the PLC program from running	Faulty or missing PLC module PLC is not properly configured	Contact Honeywell Analytics Service
305	DATA LOG FAILED	Unable To Log Conc Data		Failure to store concentration data in the database	Local database file has reached size limit (1GB maximum size for Access database).	Enable automatic database purge or adjust database purge settings to purge old data
413	CMD ERR AZ #-#	Cmd Error Az #-#		Analyzer not responding DAq Communica-tions	Cable connections	Check Ethernet connections
					Analyzer missing or powered down	Remove analyzer from Configuration Profile

6.5 Information Events

The Vertex M System enters informational and other non-fault events into the event history database. These do not require any action by the user.

Use the event history to check the status of the monitor.

Event Type In History	Event History Message	Possible Cause
ALM SIMULATE	Various	An alarm was artificially created. See Section 4.6.6 Security Access .
ALM 1	Concentration > AL1	Gas concentration exceeded limit
ALM 2	Concentration > AL2	Gas concentration exceeded limit
ALM WARNING	Concentration > Warning	Gas concentration exceeded lower detection limit
AZ NO RECORD	Various	A fault was cleared in the DAq for which the analyzer has no record
AZ PROGRAM INSTALL	Various	The analyzer program update process was started
CALIBRATION	Command – Valves Auto Balance	Auto Balance was started
CONFIG INSTALL	Various	The configuration profile installation was started
DEFAULT RESET	Various	A fault was cleared in the DAq from an analyzer that is no longer present in the rack
FAULT SIMULATE	Various	A fault was artificially created. See Section 4.6.6 Security Access .
INFO	20 mA Loop Test Ended	User initiated action
INFO	20 mA Loop Driven for Test	User initiated action
INFO	Window Zero Reset	Optics defect detected and corrected
INFO	Analyzer accepts new location	Analyzer moved
INFO	Analyzer Powered Up	User initiated action
INFO	Az Button Resets Alm&Flts	Internal override pushbutton operated
INFO	Az Button Starts Monitoring	Internal override pushbutton operated
INFO	Az Button Stops Monitoring	Internal override pushbutton operated
INFO	Clock Adjusted By DAq PC	Normal drift or clock set on DAq
INFO	Flow Auto Balance Performed	User initiated action
INFO	Hardware Configuration Changed	Auto Balance, Load CC, New Location or Pump Alternated

Event Type In History	Event History Message	Possible Cause
INFO	LED Drive Adjusted	Load CC
INFO	Monitoring stopped for no pts	All points disabled by faults
INFO	New Chemcassette Was Installed	User initiated action
INFO	New Sector Started	Normal maintenance
INFO	Optics Verified Successfully	Load CC
INFO	Program Loaded	User initiated action
INFO	Pump Selection Resynchronized	Analyzer installed in different system
INFO	Q-Factor Set	Load CC
INFO	Rebooted W	Watchdog reboot of analyzer
INFO	Run-Time Alarm Disable	User initiated action
INFO	Run-Time Alarm Disable Cancel	User initiated action
INFO	Run-Time Point Disable	User initiated action
INFO	Run-Time Point Disable Cancel	User initiated action
INFO	Start Monitor	User or power restored
INFO	Stop Monitor	User or instrument fault
INFO	User Requested Pump Switch	User initiated action
INFO	OPC Driver Started	The DAq booted
INFO	OPC Driver Shut Down	User initiated action
INFO	CPLD Programmed Successfully	A new program has been loaded into the sensor board CPLD chip
INFO	CPLD Program Failed	An attempt to load a new program into the sensor board CPLD chip failed
INFO	RFID Read Skipped	User loaded new Chemcassette but skipped reading the RFID tag by pressing <next>
OPC	No Ack Echo From Az n-n	Communications problem to analyzer
OPC	No Cmnd Socket Sent To Az n-n	Communications problem to analyzer
OPC	OPC To Az n-n Communication Broken	Communications problem to analyzer
OUT OF ALARM	Various	Non-latching alarm level decreased because of decrease in gas concentration
PLC CONF INSTALL	Various	Download PLC Configuration was started
RESET ALM n	Various	Latching alarm level decreased because user pressed RESET CURRENT or RESET ALL
RESET ALM SIMULATE	Various	Analyzer acknowledges command to reset an artificial alarm OR fault
RESET INST FAULT	Various	Analyzer acknowledges command to reset an instrument fault
RESET MAINT FAULT	Various	Analyzer acknowledges command to reset a maintenance fault
USER RESET	Various	A user pressed RESET CURRENT or RESET ALL
INFO	Flow Corrected	Flow on one window of tape improper

6.5.1 LIT-Related Informational Events

Event Type In History	Event History Message	Possible Cause
INFO	Command - Perform LIT Char	User pressed "START LIT CHAR" button
INFO	LIT Characterization Performed	Analyzer completed LIT characterization. If data field non-zero, this indicates the observed cracking pressure in inches Hg.
INFO	Command - Unscheduled LIT	User pressed "START LIT TEST"
INFO	Line Integrity Test Performed	Analyzer completed an integrity test. The data field contains the observed cracking pressure in inches Hg.
INFO	Analyzer Lacks LIT	Other analyzers in the rack performed a Line Integrity Test but this analyzer was purchased without the option.

Note:

If additional or replacement Vertex M Analyzers are purchased without specifying the LIT option, no faults will be generated for the lack of the option in the new analyzer. However, an "INFO" message will be logged in the Event History each time the LIT option is invoked. Existing analyzers configured for LIT will be unaffected.

6.6 Manual Analyzer Override

The Vertex M Analyzer is equipped with a “Manual Override” button (Figure 6-1) in the event the communications to the Vertex M Data Acquisition (DAQ) computer halts. This button activates only when the communications has completely ceased.

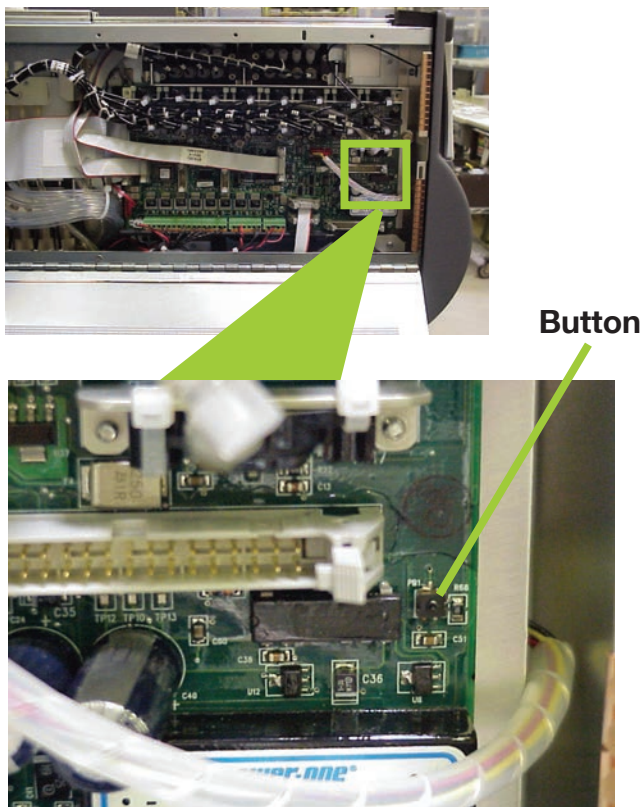

Figure 6-1. Vertex M Analyzer Manual Override Button Location

There are cases where the DAQ appears to be “frozen” or “locked-up” (no response from the keyboard and/or any user invoked actions after a few moments) when in reality this is not the case. Events that could cause these symptoms include AC power surges or sags and improper shut-downs of the DAQ that result in file corruption. As a result, future attempts to access these

files can slow down the response of the DAQ. To confirm a non-responsive DAQ as opposed to frozen/locked-up, check the clock located in the upper right hand corner of the Vertex M HMI window (shown in Figure 6-2). If the clock is still advancing, then the DAQ CPU is not frozen/locked-up and your local Authorized Service Center needs to be contacted for assistance.

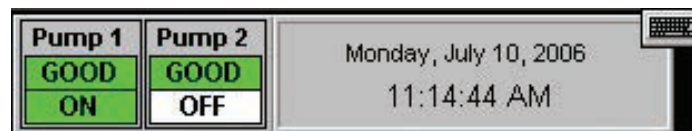

Figure 6-2. Vertex M HMI Clock

On occasions, there may be the need to install a new Chemcassette® to continue monitoring your facility, or to reset alarms or faults. If the DAQ is not responding, these tasks can be performed using the “Manual Override” button. An extra step may be required to “force” activation of the “Manual Override” button under the above mentioned conditions if the DAQ computer is still communicating with the analyzers. The following instructions will instruct you on how to accomplish this task:

Note:

Performing this task will generate Maintenance Fault F111 – DACS COM FAIL

1. Manually release the Analyzer by sliding the Removal key into slot located in the bottom of the Analyzer front (key located in Software Binder shipped with each Vertex M rack) and slide the Analyzer out of the cabinet.

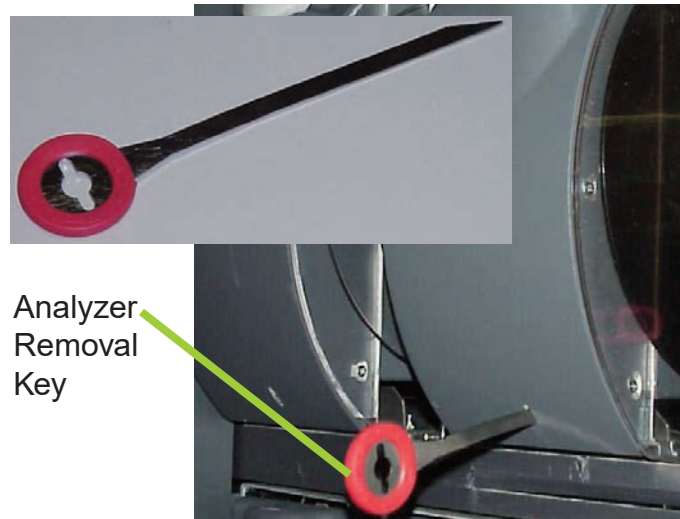

Figure 6-3. Vertex M Analyzer Removal Key and Slot Location

2. Locate the Ethernet cable on the rear panel and disconnect it.

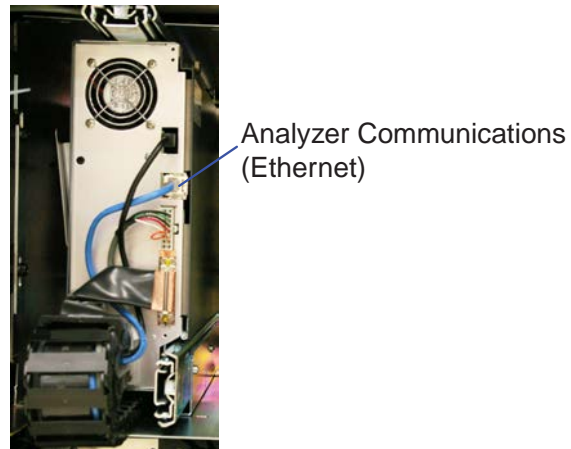

Figure 6-4. Analyzer Ethernet Communication Cable Location

3. Open the side of the Analyzer by unscrewing the 4 thumbscrews at the top of the left side.

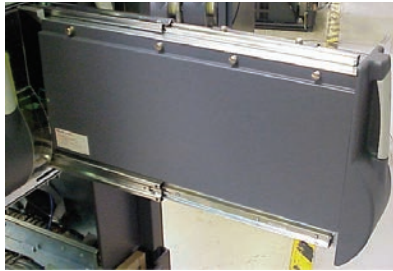

Figure 6-5. Analyzer

4. Approximately 20 seconds after the Ethernet Cable has been disconnected, the Analyzer will recognize that it has lost communications with the DAq and activate the “Manual Override” button shown in [Figure 6-1](#). The LEDs on the front of the Analyzer will flash to show a Maintenance Fault per the LED status flash pattern shown in Table 6-1.

To reset faults and alarms:

Press and hold button for 1-3 seconds.

To Put Analyzer into Monitor mode:

Press and hold button for 4-9 seconds

To Exit Monitor and Open Gate:

Press and hold button for 10 seconds and above

5. Close and reattach the Analyzer cover, reconnect the Ethernet communications cable, and then slide the Analyzer into the cabinet.

Mon State	Alarm State	Fault State	time in millesconds									
			500	400	100							
idle	0	none	black			green						
		maintenance	amber			black						
		instrument	amber	black								
	1	any	red			black						
	2	any	red	black								
pyrolyzer warmup	0	none	green	black								
		m or i	green	black	amber							
	1	any	green	black	red							
monitoring	0	none	green			black						
		maintenance	amber			green						
		instrument	amber	green								
	1	any	red			green						
	2		red	green								
primary program invalid			amber	black	amber	black	amber	black	amber	black	amber	black
unpowered			black									
lockup			green									
			amber									
			red									

Table 6-1. Analyzer Status LEDs

A Installation Drawings

A.1 Introduction

PRINTED 16 Dec 2015 -- 7:47am

THIS PAGE LEFT BLANK INTENTIONALLY.

4	12/15/15	REVISED FRONT AND REAR ACCESS REQUIREMENTS SHT2, PER ECO 8772	RC	
3	09/17/12	EXHAUST TUBING: TEFLON WAS POLYETHYLENE SHT3, PER ECO 8142	JT	
2	06/30/10	ADDED WEIGHT SHT2, ADDED HA PART #'s ON SHT3, CORRECTED LINE/GND/NEUT CALLOUT SHT 4 PER ECO 7829	RC	
1	02/27/09	RELEASED FOR PRODUCTION/	JAT	
A	11/20/08	DRAWN/	DJB	
REV	DATE	DESCRIPTION OF REVISION	CAD	CHKD.

REVISION RECORD

FIRST PARENT P/N: DRAWING RELEASE NO.:



DO NOT SCALE DRAWING. THIS DRAWING AND THE INFORMATION CONTAINED HEREIN ARE PROPRIETARY TO HONEYWELL ANALYTICS INC. AND SHALL NOT BE USED IN WHOLE OR IN PART WITHOUT THE EXPRESS WRITTEN PERMISSION OF HONEYWELL ANALYTICS INC.	TOLERANCES UNLESS OTHERWISE SPECIFIED INCH (MM)		DRAWING TITLE: VERTEX M INSTALLATION DRAWING		
	X/X ± 1/32 (0.79)	APPROVED BY:	SIGNATURE	DATE	
	.X ± .015 (0.38)	MANUFACTURING ENGINEER	R. CHILUK	6-30-10	
	.XX ± .010 (0.25)	PROJECT ENGINEER	J. TIWET	7-6-10	
.XXX ± .005 (0.13)	QUALITY ASSURANCE	H. CHROMCZAK	7-9-10	SCALE: N/A	DRAWING NO.: 1290G0050
ANGLES ± 1°				REV 4	SHEET 1 OF 8

BSIZE.DWG REV. OCT. 2005

Vertex M™ 24-Point Continuous Monitor



A.2 Floor Space Requirements

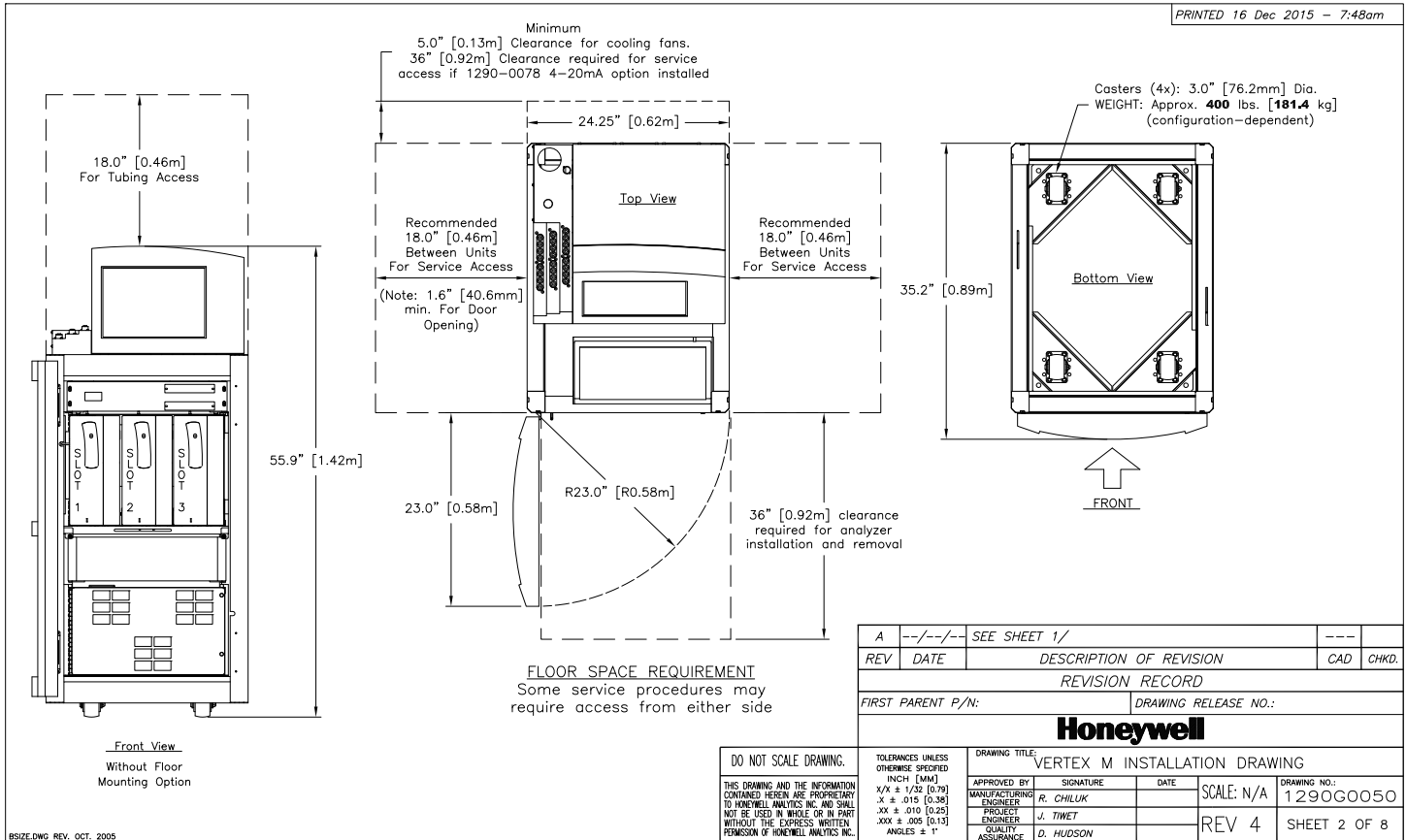

Vertex M™ 24-Point Continuous Monitor

A.3 General Considerations and Cooling

PRINTED 16 Dec 2015 -- 7:49am

General Connections & Cooling

Refer to sheet-5 for EMC Considerations

1. Table: Transport Times in Seconds

Length in Feet	0.25" Outside Diameter Tubing								
	0.156"(Medium Wall) I.D. Ⓞ				0.190"(Thin Wall) I.D. Ⓞ				
Length in meters	100	200	300	400	100	200	300	400	
	30.5m	61.0m	91.4m	121.9m	30.5m	61.0m	91.4m	121.9m	
# of Analyzers Per line	1	15	30	45	60	22	45	67	89
	2	8	15	Pressure Limited		11	22	34	45
	3	5	Pressure Limited		7	15	Pressure Limited		

Nominal Transport Time in Seconds
1.3–1.8 Liters per Minute per Point (1.5 LPM nominal)

Pressure limited areas: expected pressure to exceed 5 inHg

- Ⓞ HA PN: 0235-0157 (0.156" I.D.), 400-ft [121.9m] roll
- Ⓞ HA PN: 0235-0109 (0.190" I.D.), 1000-ft [304.8m] roll

2. Sample Line Filter Recommendations:

Refer to Manual, Section B.1, for filter requirements for specific gases.

HA PN: **780248** Dust Filter (One per line) – TYPE-A
HA PN: **1830-0055** Filter for Corrosive Gases – TYPE-B (One per line)

HA PN: **0235-1072** Replacement "corrosive" filter elements (Pack of 100)

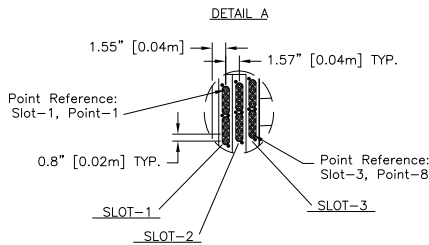
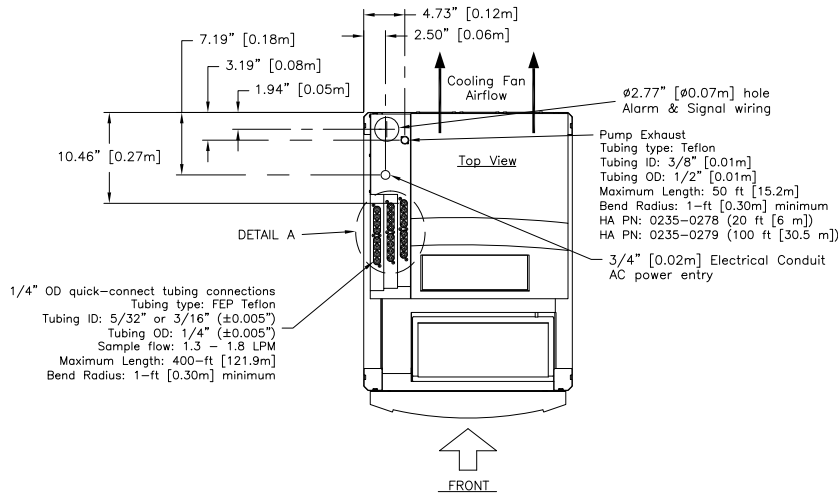

A	--/--/--	SEE SHEET 1/	---	---
REV	DATE	DESCRIPTION OF REVISION	CAD	CHKD.

REVISION RECORD

FIRST PARENT P/N:	DRAWING RELEASE NO.:
-------------------	----------------------

Honeywell

DO NOT SCALE DRAWING.		TOLERANCES UNLESS OTHERWISE SPECIFIED INCH [MM]		DRAWING TITLE: VERTEX M INSTALLATION DRAWING	
THIS DRAWING AND THE INFORMATION CONTAINED HEREIN ARE PROPRIETARY TO HONEYWELL ANALYTICS INC. AND SHALL NOT BE USED IN WHOLE OR IN PART WITHOUT THE EXPRESS WRITTEN PERMISSION OF HONEYWELL ANALYTICS INC.		X/X ± 1/32 [0.79]	.X ± .015 [0.38]	.XX ± .010 [0.25]	.XXX ± .005 [0.13]
APPROVED BY:	SIGNATURE	DATE	SCALE: N/A	DRAWING NO.: 1290G0050	
MANUFACTURING ENGINEER	R. CHILUK		REV 4	SHEET 3 OF 8	
PROJECT ENGINEER	J. TIWET				
QUALITY ASSURANCE	D. HUDSON				

Vertex M™ 24-Point Continuous Monitor

A.4 General Wiring

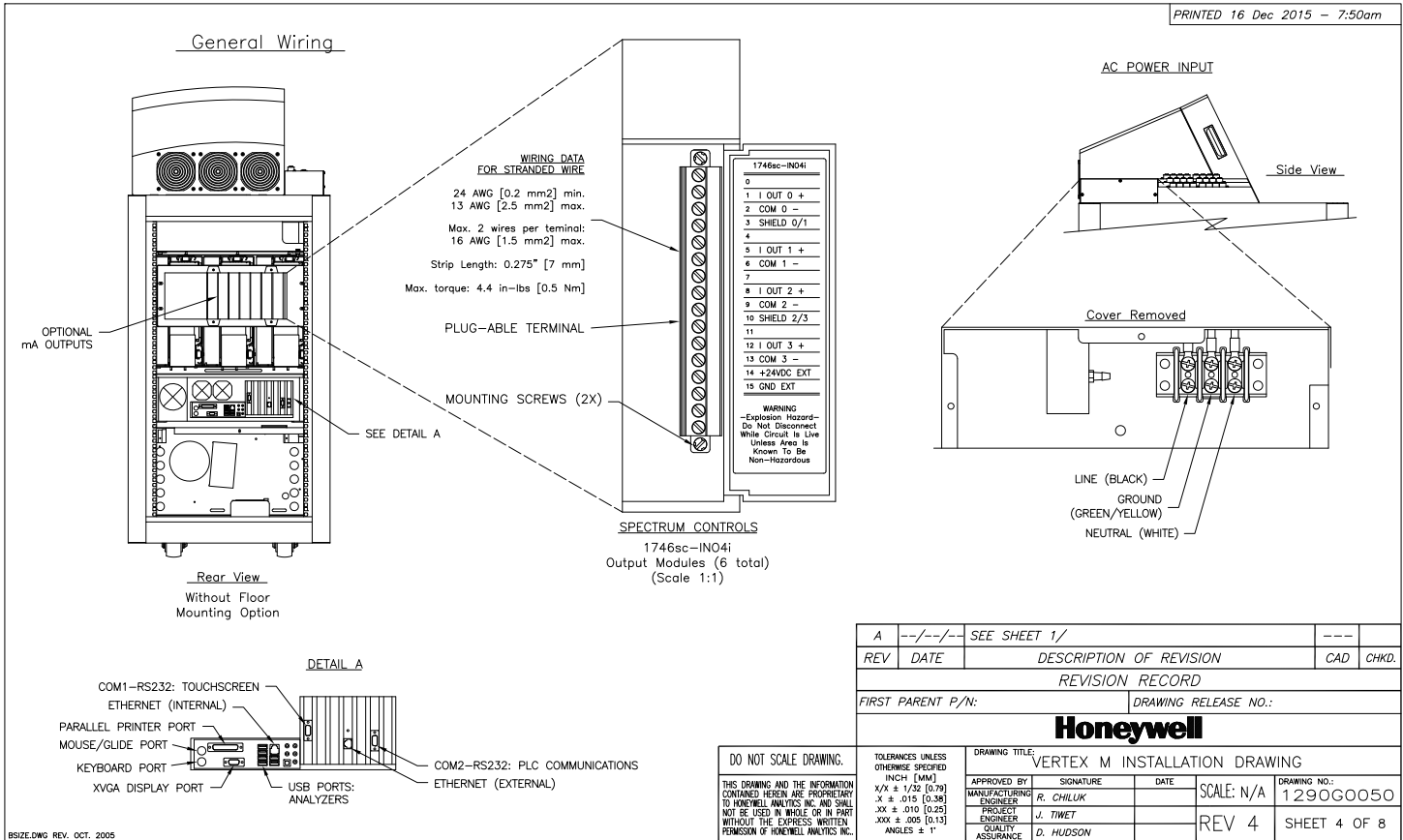

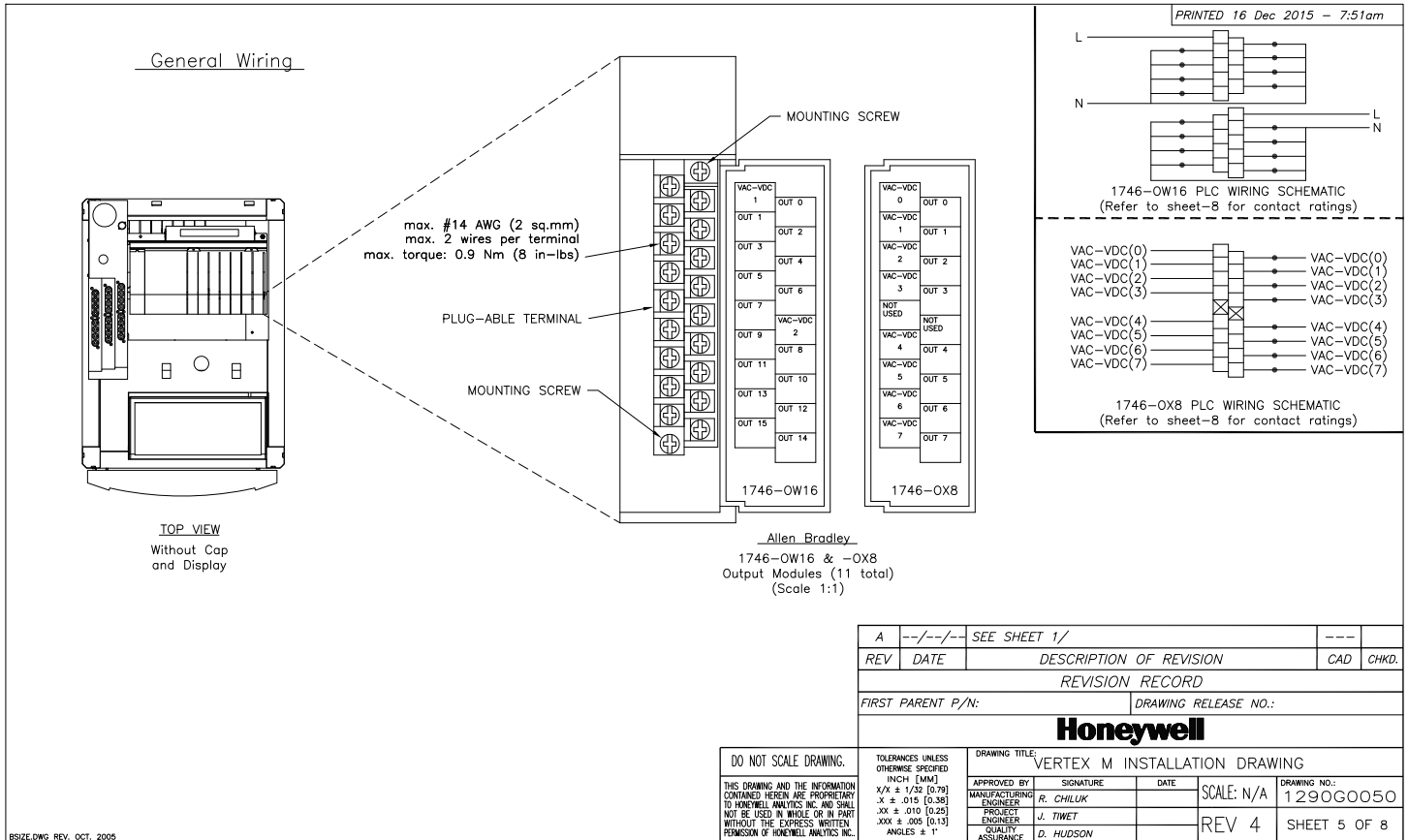

A	--/--/--	SEE SHEET 1/	---		
REV	DATE	DESCRIPTION OF REVISION	CAD	CHKD.	
REVISION RECORD					
FIRST PARENT P/N:			DRAWING RELEASE NO.:		
Honeywell					
DRAWING TITLE: VERTEX M INSTALLATION DRAWING					
DO NOT SCALE DRAWING.		TOLERANCES UNLESS OTHERWISE SPECIFIED		DRAWING NO.: 1290G0050	
<small>THIS DRAWING AND THE INFORMATION CONTAINED HEREIN ARE PROPRIETARY TO HONEYWELL ANALYTICS INC. AND SHALL NOT BE USED IN WHOLE OR IN PART WITHOUT THE EXPRESS WRITTEN PERMISSION OF HONEYWELL ANALYTICS INC.</small>		<small>INCH (MM)</small> X ± 1/32 (0.79) X ± .015 (0.38) XX ± .010 (0.25) XXX ± .005 (0.13) ANGLES ± 1°		SCALE: N/A	
		APPROVED BY: <u>R. CHILUK</u> SIGNATURE DATE		REV 4 SHEET 5 OF 8	
		MANUFACTURING ENGINEER: <u>J. TIWEL</u>			
		PROJECT ENGINEER: <u>D. HUDSON</u>			

BSIZE.DWG REV. OCT. 2005

A.5 4-Port Manifold Option

PRINTED 16 Dec 2015 -- 7:51am

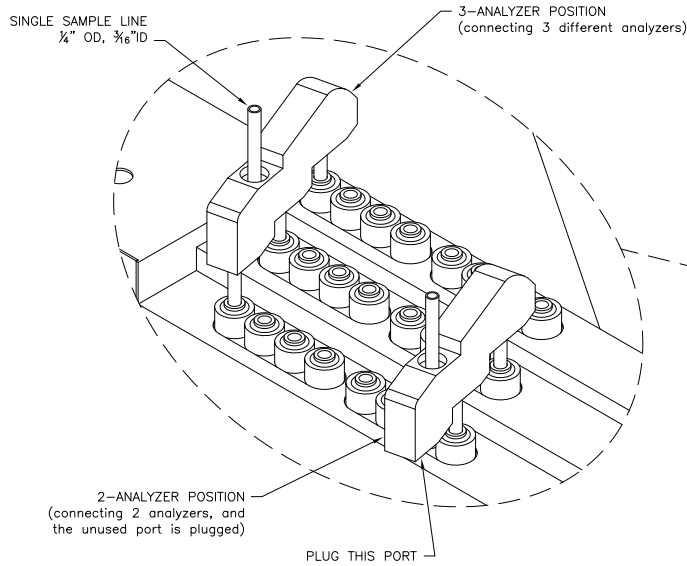

4-PORT MANIFOLD OPTION: 1295-0322
 TO SHARE A SAMPLE LINE BETWEEN 2 OR 3 POINTS, KIT INCLUDES 3 CONNECTION TUBINGS AND 1 PLUG (TO BE USED WHEN SHARING BETWEEN 2 POINTS).
NOTE: The manifold can only share lines between the same point number on 3 different analyzers (or same point number on 2 analyzers).

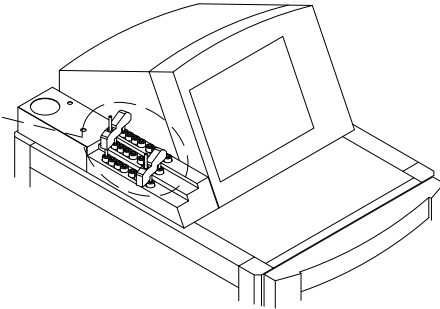

A	--/--/--	SEE SHEET 1/	---	
REV	DATE	DESCRIPTION OF REVISION	CAD	CHKD.
REVISION RECORD				

FIRST PARENT P/N:	DRAWING RELEASE NO.:
Honeywell	

DO NOT SCALE DRAWING. THIS DRAWING AND THE INFORMATION CONTAINED HEREIN ARE PROPRIETARY TO HONEYWELL ANALYTICS INC. AND SHALL NOT BE USED IN WHOLE OR IN PART WITHOUT THE EXPRESS WRITTEN PERMISSION OF HONEYWELL ANALYTICS INC.	TOLERANCES UNLESS OTHERWISE SPECIFIED (INCH) (MM) X/X ± 1/32 (0.79) X ± .015 (0.38) .XX ± .010 (0.25) .XXX ± .005 (0.13) ANGLES ± 1°	DRAWING TITLE: VERTEX M INSTALLATION DRAWING		SCALE: N/A DRAWING NO.: 129OG0050 REV 4 SHEET 6 OF 8
	APPROVED BY: R. CHILUK MANUFACTURING ENGINEER	SIGNATURE: J. TIWET PROJECT ENGINEER	DATE: D. HUDSON QUALITY ASSURANCE	
	THIS DRAWING AND THE INFORMATION CONTAINED HEREIN ARE PROPRIETARY TO HONEYWELL ANALYTICS INC. AND SHALL NOT BE USED IN WHOLE OR IN PART WITHOUT THE EXPRESS WRITTEN PERMISSION OF HONEYWELL ANALYTICS INC.			
	DO NOT SCALE DRAWING.			

BSIZE.DWG REV. OCT. 2005

A.6 Floor Mounting Option

PRINTED 16 Dec 2015 -- 7:52am

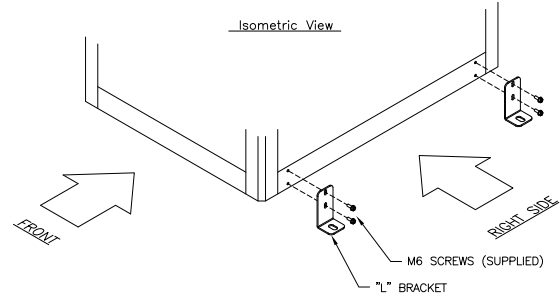
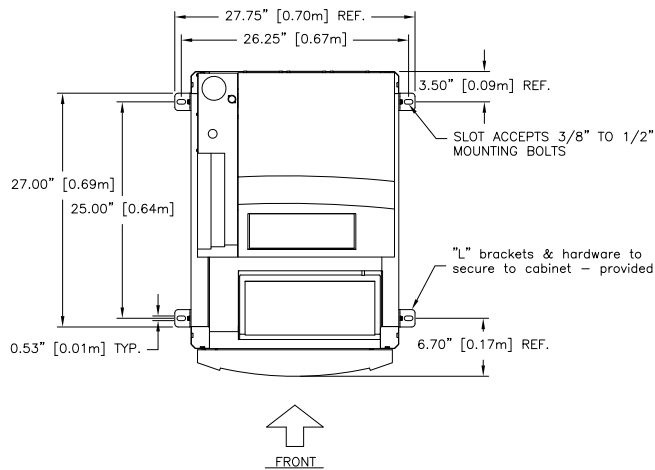

1290K0064
Floor Mounting Option

NOTES:

- Hardware are provided to secure "L" brackets to the base of Vertex-M and to a cement floor.

A	--/--/--	SEE SHEET 1/	---	
REV	DATE	DESCRIPTION OF REVISION	CAD	CHKD.
REVISION RECORD				

FIRST PARENT P/N: DRAWING RELEASE NO.:

Honeywell

<p>DO NOT SCALE DRAWING.</p> <p>THIS DRAWING AND THE INFORMATION CONTAINED HEREIN ARE PROPRIETARY TO HONEYWELL ANALYTICS INC. AND SHALL NOT BE USED IN WHOLE OR IN PART WITHOUT THE EXPRESS WRITTEN PERMISSION OF HONEYWELL ANALYTICS INC.</p>	<p>TOLERANCES UNLESS OTHERWISE SPECIFIED</p> <p>(INCH) (MM)</p> <p>X/4 ± 1/32 (0.79)</p> <p>X ± .015 (0.38)</p> <p>.XX ± .010 (0.25)</p> <p>.XXX ± .005 (0.13)</p> <p>ANGLES ± 1°</p>		<p>DRAWING TITLE: VERTEX M INSTALLATION DRAWING</p>		
	<p>APPROVED BY:</p> <p>MANUFACTURING ENGINEER</p> <p>PROJECT ENGINEER</p> <p>QUALITY ASSURANCE</p>	<p>SIGNATURE</p> <p>R. CHILUK</p> <p>J. TIWET</p> <p>D. HUDSON</p>	<p>DATE</p>	<p>SCALE: N/A</p> <p>REV 4</p>	<p>DRAWING NO.:</p> <p>1290G0050</p> <p>SHEET 7 OF 8</p>

BSIZE.DWG REV. OCT. 2005

EMC Consideration

Overview

Your Zellweger Analytics MDA Scientific Instrument has been designed to comply with applicable Electromagnetic Compatibility (EMC) standards at the time of manufacture. The design includes filtering, shielding and bypassing techniques. At the time of certification, simulated customer Input/Output (I/O) schemes were tested.

All methods used in your equipment for emission suppression and reduction of susceptibility are interactive. Modifications to the instrument will most likely result in increased emission and higher vulnerability to other radiated fields.

Following the guidelines in this EMC Considerations section will ensure your instrument maintains the highest degree of EMC integrity. The guidelines list apply only to I/O emissions and do not apply to A.C. and D.C. Instrument power connections.

Cabling

At a very minimum, all cables should include a braided shield. Ideal results have been obtained with twisted pair cabling which has a foil shield surrounding each pair plus foil and 90% braided shielding around the bundle. While this yields the best results, it can be very expensive. In addition, ensure local electrical code requirements are met.

Cabling Type

The following cable parameters must be considered:

Braid

Must have a minimum 90% coverage

Foil

When used with braid, provides 100% coverage.

Note: Do not use foil alone. It has a tendency to break.

Twisted Pair

Provides for canceling of magnetic fields.

Stranded Pair

Provides the greatest surface area.

MDA Scientific product testing uses >90% braid with foil (around the bundle); twisted pair; stranded 24 AWG (minimum wiring for all qualification and certification testing.)

Shield Termination

Continuation of the shield to the cabinet is most important.

For discrete wire termination, pigtails to the cabinet (connector) ground should be extremely short (absolutely no greater than three inches).

For multiconductor connector terminations, only 360° shielded shells should be used.

Connectors

All qualification and certification of MDA Scientific products were achieved with high quality connectors, providing 360° shield coverage. These connectors generally had metal shells.

Failure to properly secure the connector to the equipment will result in high emission levels. Also, poorly constructed or improperly assembled connectors can be a high source of radiated noise and provide a path for external signals into the instrument.

1. OPERATING VOLTAGE:

SINGLE-PHASE PROVIDING HOT, NEUTRAL & GROUND LINES
110/220 VAC ±10%, (UNDERLOAD) 50/60Hz, 15 AMP
3000 VA/3500 WATTS/12,000 BTU/Hr
AN EASILY ACCESSIBLE SERVICE DISCONNECT/POWER SWITCH MUST BE INSTALLED NEAR THE INSTRUMENT.

WARNING:

POWER SWITCH ON UNIT DOES NOT DISCONNECT ALL ELECTRICAL POWER.

2. **WIRING:** ELECTRICAL INSTALLATION MUST COMPLY WITH NEC, NFPA AND OTHER LOCAL CODES.

3. RELAY OUTPUT MODULES (1746-OW16, -OX8)

Specifications	1746-OW16 (RTB)	1746-OW8 (RTB)
Operating Category	ac/dc Relay	
Operating Voltage	5 to 265V ac 47 to 63 Hz/5 to 125V dc	
Number of Outputs	16	8
Points per Common	8	Individually Isolated
Backplane	5V 0.170A	0.085A
Current Draw	24V 0.180A	0.090A
Single Delay(max)-resistive load	on=10ms / off=10ms	
Off-State Leakage(max)	0 mA	
Load Current(min)	10 mA at 5V dc	
Continuous Current per Point ^① (max)	Refer to the Relay Contact Ratings-sheet 4	
Continuous Current per Module(max)	16.0A ac	②
Current per Common (max)	8.0A	

PRINTED 16 Dec 2015 - 7:53am

4. RELAY CONTACT RATINGS FOR 1746-OW16:

	Maximum Volts	Amperes ^①		Amps ^② Cont.	Volt-Amps	
		Make	Break		Make	Break
ac	240V ac	7.5A	0.75A	2.5A	1800 VA	180 VA
	120V ac	15.0A	1.50A			
dc	125V dc	0.22A ^③		1.0A	28 VA	
	24V dc	1.2A ^③				

5. RELAY CONTACT RATINGS FOR 1746-OW8:

	Maximum Volts	Amperes ^①		Amps ^② Cont.	Volt-Amps	
		Make	Break		Make	Break
ac	240V ac	1.5A	1.5A	5.0A	3600A	3600A
	120V ac	3.0A	3.0A			
dc	125V dc	0.22A ^③		1.0A	28 VA	
	24V dc	1.2A ^③				

① Connecting surge suppression across your external load will extend the life of SLC 500 relay contacts. For recommended surge suppressors when switching ac inductive load, consult SLC 500 Modular Hardware Style Installation and Operation User Manual (Publication 1747-6.2) or the SLC 500 Fixed Hardware Style Installation and Operation User Manual (Publication 1747-6.2.1). Recommended surge suppression for switching 24Vdc inductive load is a 1N4004 diode reverse wired across the load.

② The continuous current per module must be limited so the module power does not exceed 1440VA.

③ For dc voltage application, the make/break ampere rating for relay contacts can be determined by dividing the 28 VA by the applied dc voltage. For example, 28VA/ASV dc=0.58A. For dc voltage applications less than 14V, the make/break for relay contacts cannot exceed 2A.

RTB=Removal Terminal Block

A	--/--/--	SEE SHEET 1/	---	
REV	DATE	DESCRIPTION OF REVISION	CAD	CHKD.
REVISION RECORD				
FIRST PARENT P/N:		DRAWING RELEASE NO.:		
Honeywell				
DRAWING TITLE: VERTEX M INSTALLATION DRAWING				
DO NOT SCALE DRAWING.		TOLERANCES UNLESS OTHERWISE SPECIFIED INCH [MM] X/X ± 1/32 [0.79] .X ± 0.15 [0.38] .XX ± 0.10 [0.25] XXX ± .005 [0.13] ANGLES ± 1°	DRAWING NO.: SCALE: N/A 1290G0050 REV 4 SHEET 8 OF 8	
THIS DRAWING AND THE INFORMATION CONTAINED HEREIN ARE PROPRIETARY TO HONEYWELL ANALYTICS INC. AND SHALL NOT BE USED, IN WHOLE OR IN PART, WITHOUT THE EXPRESS WRITTEN PERMISSION OF HONEYWELL ANALYTICS INC.		APPROVED BY: R. CHILLIK MANUFACTURING ENGINEER PROJECT ENGINEER: J. TINET QUALITY ASSURANCE: D. HUDSON	SIGNATURE: _____ DATE: _____	

BSIZE.DWG REV. OCT. 2005

A Specifications

A.1 Introduction

Appendix B consists of the following sections:

- [B.2 Filter Compatibility](#)
- [B.3 Physical Dimensions](#)
- [B.4 Nominal Transport Times](#)

A.2 Filter Compatibility

The following table shows sample filter requirements.

If you are monitoring non-corrosive target gases, use filter type A, (P/N 780248), a sample line dust/particulate filter.

For monitoring corrosive gases, such as chlorine (Cl₂), hydrogen fluoride (HF), hydrogen chloride (HCl), and hydrogen bromide (HBr), sample lines in a dusty environment or for outdoors, use filter type B, (P/N 1830-0055), or type C, (P/N 1991-0147) filter assembly for corrosive gases. The Teflon membrane particulate filter is designed to prevent dust and dirt greater than one micron from entering the sample line. Unlike standard particulate filters, it does not exhibit sample loss with corrosive monitoring.

The one micron Teflon membrane contained in the filter housing (P/N 0235-1072, 100 per pack) should be replaced every 30 days.

Filters have an arrow on the side of the filter pointing in the direction of airflow toward the Vertex M system. Replacement of filters is site dependent.

Filter A - P/N 780248

Filter B - P/N 1830-0055

Filter C - P/N 1991-0147

Symbol	Name	Filter Type A	Filter Type B	Filter Type C
NH ₃	Ammonia		X	X
AsH ₃	Arsine	X		
AsH ₃ D	Arsine (Dry)	X		
AsH ₃ LL	Arsine (Low level)	X		
BF ₃	Boron Trifluoride		X	X
Cl ₂	Chlorine		X	X
ClO ₂	Chlorine Dioxide		X	X
Cl ₂ LL	Chlorine (Low Level)		X	X
B ₂ H ₆	Diborane	X		
DMA	Dimethylamine		X	X
F ₂	Fluorine		X	X
GeH ₄	Germane	X		
HBr	Hydrogen Bromide		X	X
HBr LL	Hydrogen Bromide (Low Level)		X	X
HCl	Hydrogen Chloride		X	X
HCl LL	Hydrogen Chloride (Low Level)		X	X
HCN	Hydrogen Cyanide	X		
HF	Hydrogen Fluoride		X	X
HF LL	Hydrogen Fluoride (Low Level)		X	X
HI	Hydrogen Iodide		X	X
H ₂ Se	Hydrogen Selenide	X		
H ₂ S	Hydrogen Sulfide	X		
H ₂ S LL	Hydrogen Sulfide (Low Level)		X	X
NO ₂	Nitrogen Dioxide	X		
NF ₃	Nitrogen Trifluoride	X		
COCl ₂	Phosgene	X		
PH ₃	Phosphine	X		
SiH ₄	Silane	X		
SO ₂	Sulfur Dioxide		X	X
TBA	Tert-butyl Arsine	X		
TBP	Tert-butyl Phosphine	X		
TDMAT	Tetrakis(DimethylAmino) Titanium		X	X

Table A-1. Sample Filter Requirement Vertex M General Specifications

A.3 Physical Dimensions

- Height: 57 in. (144.8 cm)
- Width: 24 in. (61 cm)
- Depth: 36 in. (91 cm)
- Weight: ~550 lbs. (249 kg) with 3 analyzers
- Universal Az: 31 lbs. (14 kg)
- Pyrolyzer Az: 48 lbs. (22 kg)
- Empty Vertex M Rack: 457 lbs. (207 kg)

Tubing dimensions:

- Sample lines: 1/4 in. (6.35 mm)
- O.D. x 0.190 in. (4.83 mm) I.D. FEP Teflon
- or 1/4 in. (6.35 mm) O.D. x 0.156 in. (3.9 mm) I.D. FEP Teflon
- Exhaust line: 1/2 in. (12.7 mm) O.D. x 3/8 in. (9.5 mm) I.D. Teflon tubing, 50 ft. (15 m) maximum

Output requirements:

- Optional data output: See [Appendix F Network Interface and Options](#).
- Optional relay output contacts: Via PLC, normally open (form A). 32 isolated or 64 non-isolated contacts are user configurable. All relays are undefined by default, and must be configured as required. See [Appendix E. Optional Relay Specifications](#).
- Optional 4-20 mA analog: 0-500 ohms
- Installation Category
- (overvoltage category): II (UL 61010B-1)
- Temperature: 59°F to 95°F (15°C to 35°C)
- Humidity: 20-65% RH
- Operating Altitude: -1000 ft. (-305 m) to 6000 ft. (1829 m) above sea level
- Operating Voltage: 110 or 230 VAC \pm 10% (under load) @ 50/60 Hz; 15 Amps maximum, single phase. See [Section 2.6 Electrical Power](#) for proper specifications.

A.4 Nominal Transport Times

The following table shows the time required for samples to move from the sampling point to the Vertex M system for various lengths of sample lines.

O.D.		0.25 in. Outside Diameter Tubing							
I.D.		0.15 in. (Medium Wall) I.D.				0.190 in. (Thin Wall) I.D.			
Length in Feet		100	200	300	400	100	200	300	400
Length in Meters		30	61	91	122	30	61	91	122
# of Analyzers per line	1	15 sec.	30 sec.	45 sec.	60 sec.	22 sec.	45 sec.	67 sec.	89 sec.
	2	8 sec.	15 sec.			11 sec.	22 sec.	34 sec.	45 sec.
	3	5.0 sec.	Pressure Limited			7 sec.	15 sec.	Pressure Limited	
	Nominal Transport Time in Seconds 1.3-1.8 Liters per Minute per Point (1.5 LPM nominal)								

Table A-2. Nominal Transport Times

A Detectable Gases

A.1 Detectable Gases

Vertex M System Chemcassette® analyzers are continuous monitoring instruments. The initial analysis period listed in Table C-1 varies based on the programmed alarm levels. This period is valid only after the system pulls a new Chemcassette® window. Increasing the programmed alarm levels will decrease the initial sample period.

For accurate detection, gas must be present at sufficient levels and durations. Typical response times are shown in this table at 2 TLV, which will vary in duration depending on the target gas and alarm level settings. For high concentrations (greater than full scale) a minimum of 4 seconds is required.

Gas Name ¹	TLV	LAL	LDL	Default Alarm Level 1	Default Alarm Level 2	Range	Alarm Setting	Initial Analysis Period (second)	Time to 1 TLV (Alarm @ 2 TLV Concentration 10-ft. Sample Line)	Chemcassette Part Number
Ammonia II (NH ₃)	25 ppm	3 ppm	3 ppm	25 ppm	50 ppm	0-75 ppm	3-49.9 ppm 50-75 ppm	10 10	<20 sec	1295-0221
Ammonia XP (NH ₃)	25 ppm	1.5 ppm	1.5 ppm	25 ppm	50 ppm	0-150 ppm	1.5-49.9 ppm 50-150 ppm	10 10	<20 sec	1295-0405
Ammonia XP4 (NH ₃)	25 ppm	1.5 ppm	1.5 ppm	25 ppm	50 ppm	0-150 ppm	1.5-49.9 ppm 50-150 ppm	10 10	<20 sec	1257-9309
Arsine (AsH ₃)	5 ppb	5 ppb	5 ppb	50 ppb	100 ppb	0-500 ppb	5-500 ppb	30	<20 sec (Alarm @ 50 ppb with 100 ppb AsH ₃ gas)	1295-0300
Arsine (AsH ₃)	50 ppb	3 ppb	2.5 ppb	50 ppb	100 ppb	0-500 ppb	3-14.9 ppb 15-59.9 ppb 60-249.9 ppb 250-500 ppb	60 60 30 15	<16 sec (Alarm @ 50 ppb with 100 ppb gas)	1295-0566
Arsine (AsH ₃ /L)	5 ppb	0.5 ppb	0.3 ppb	5 ppb	10 ppb	0-50 ppb	0.5-1.9 ppb 2-4.9 ppb 5-9.9 ppb 10-50 ppb	180 150 60 30	<70sec (Alarm @ 5ppb with 10ppb gas)	1295-0566
Arsine (AsH ₃) Dry	5 ppb	7 ppb	5 ppb	50 ppb	100 ppb	0-500 ppb	7-99 ppb 100-199 ppb 200-500 ppb	60 30 15	<35 sec (Alarm @ 50 ppb with 100 ppb AsH ₃ gas)	1295-0300

TLV - Threshold Limit Value LAL - Lowest Alarm Level LDL - Lower Detectable Limit

1. "-1" calibrations allow more stain development but will extend response times

2. Minimum Sample Time

Gas Name ¹	TLV	LAL	LDL	Default Alarm Level 1	Default Alarm Level 2	Range	Alarm Setting	Initial Analysis Period (second)	Time to 1 TLV (Alarm @ 2 TLV Concentration 10-ft. Sample Line)	Chemcassette Part Number
Arsine XP (AsH ₃) Low Level	5 ppb	0.5 ppb	0.3 ppb	2.5 ppb	5 ppb	0-50 ppb	0.5-1.9 ppb 2-4.9 ppb 5-9.9 ppb 10-50 ppb	300 150 60 30	<45 sec	1295-0226
Arsine XP (AsH ₃)	5 ppb	3 ppb	2.5 ppb	50 ppb	100 ppb	0-500 ppb	3-500 ppb	30	<20 sec (Alarm @ 50 ppb with 100 ppb AsH ₃ gas)	1295-0226
Arsine XP4 (AsH ₃)	5 ppb	3 ppb	2.5 ppb	50 ppb	100 ppb	0-500ppb	3-500 ppb	30	<20 sec (Alarm @ 50 ppb with 100 ppb AsH ₃ gas)	1257-9300
Arsine XP4 (AsH ₃) Low Level	5 ppb	0.5 ppb	0.3 ppb	2.5 ppb	5 ppb	0-50 ppb	0.5-1.9 ppb 2-4.9 ppb 5-9.9 ppb 10-50 ppb	300 150 60 30	<45 sec	1257-9300
Arsine XPV-Germene (AsH ₃)	50 ppb	3 ppb	2.5 ppb	50 ppb	100 ppb	0-500 ppb	3-14.9 ppb 15-59.9 ppb 60-249.9 ppb 250-500 ppb	60 60 30 15	<16sec (Alarm @ 50ppb with 100ppb gas)	1295-0564
Arsine XPV-Germene (AsH ₃ /L)	5 ppb	0.5 ppb	0.3 ppb	5 ppb	10 ppb	0-50 ppb	0.5-1.9 ppb 2-4.9 ppb 5-9.9 ppb 10-50 ppb	180 150 60 30	<70sec (Alarm @ 5ppb with 10ppb gas)	1295-0564
Boron Trifluoride (BF ₃) Low Level	100 ppb	120 ppb	100 ppb	125 ppb	250 ppb	0-1500 ppb	120-249 ppb 250-499 ppb 500-749 ppb 750-1500 ppb	240 120 60 30	<90 sec (Alarm @ 250 ppb with 500 ppb BF ₃ gas)	1295-0225
Boron Trifluoride XP (BF ₃)	0.1 ppm	0.12 ppm	0.1 ppm	1 ppm	2 ppm	0-10 ppm	0.12-0.99 ppm 1.0-10.0 ppm	45 30	<45 sec (Alarm @1ppm with 2ppm BF ₃ gas)	1295-0507

TLV - Threshold Limit Value LAL - Lowest Alarm Level LDL - Lower Detectable Limit

1. "-1" calibrations allow more stain development but will extend response times

2. Minimum Sample Time

Gas Name ¹	TLV	LAL	LDL	Default Alarm Level 1	Default Alarm Level 2	Range	Alarm Setting	Initial Analysis Period (second)	Time to 1 TLV (Alarm @ 2 TLV Concentration 10-ft. Sample Line)	Chemcassette Part Number
Boron Trifluoride XP4 (BF ₃)	0.1 ppm	0.12 ppm	0.10 ppm	1.0 ppm	2.0 ppm	0-10 ppm	0.12-0.90 ppm 1.0-10.0 ppm	45 30	<45 sec (Alarm @1ppm with 2ppm BF ₃ gas)	1257-9310
Chlorine (Cl ₂)	0.1 ppm	0.05 ppm	0.04 ppm	0.5 ppm	1 ppm	0-5 ppm	0.05-0.24 ppm 0.25-0.49 ppm 0.5-5 ppm	45 30 15	<25 sec (Alarm @ 0.5ppm with 1ppm Cl ₂ gas)	1295-0220
Chlorine Dioxide (ClO ₂)	100 ppb	50 ppb	50 ppb ²	100 ppb	200 ppb	0-1000 ppb	50-99 ppb 100-199 ppb 200-399 ppb 400-1000 ppb	300 240 120 60	<70 sec	1295-0220
Chlorine XP (Cl ₂)	0.1 ppm	0.05 ppm	0.05 ppm	0.5 ppm	1 ppm	0-5 ppm	0.05-0.24 ppm 0.25-5.0 ppm	45 30	<20 sec (Alarm @ 0.5ppm with 1ppm Cl ₂ gas)	1295-0227
Chlorine XP (Cl ₂) Low Level	100 ppb	30 ppb	7 ppb	250 ppb	500 ppb	0-2000 ppb	30-199 ppb 200-499 ppb 500-2000 ppb	120 90 60	<30 sec (Alarm @ 0.25ppm with 0.5ppm Cl ₂ gas)	1295-0227
Chlorine XP4 (Cl ₂)	0.1 ppm	0.05 ppm	0.05 ppm	0.5 ppm	1 ppm	0-5 ppm	0.05-0.24 ppm 0.25-5.0 ppm	45 30	<20sec (Alarm @ 0.5ppm with 1ppm Cl ₂ gas)	1257-9308
Chlorine XP4 (Cl ₂) Low Level	100 ppb	30 ppb	7 ppb	250 ppb	500 ppb	0-2000 ppb	30-199 ppb 200-499 ppb 500-2000 ppb	120 90 60	<30 sec (Alarm @ 0.25ppm with 0.5ppm Cl ₂ gas)	1257-9308
Chlorine XP-Cl ₂ -II (Cl ₂)	0.1 ppm	0.060 ppm	0.050 ppm	0.500 ppm	1.000 ppm	0 - 5.000 ppm	0.060 - 0.249 ppm 0.250 - 5.000 ppm	45 30	<45sec (Alarm @ 0.1ppm with 0.2ppmCl ₂ gas) <20sec (Alarm @ 0.5ppm with 1.0ppmCl ₂ gas)	1295-0560
Chlorine XP-Cl ₂ -II (Cl ₂ /LL) (Low Level)	0.1 ppm	0.030 ppm	0.007 ppm	0.100 ppm	0.200 ppm	0 - 1.000 ppm	0.030 - 0.099 ppm 0.100 - 0.199 ppm 0.200 - 1.000 ppm	120 90 60	<85 sec (Alarm @ 0.1ppm with 0.2ppmCl ₂ gas)	1295-0560

TLV - Threshold Limit Value LAL - Lowest Alarm Level LDL - Lower Detectable Limit

1. "-1" calibrations allow more stain development but will extend response times

2. Minimum Sample Time

Gas Name ¹	TLV	LAL	LDL	Default Alarm Level 1	Default Alarm Level 2	Range	Alarm Setting	Initial Analysis Period (second)	Time to 1 TLV (Alarm @ 2 TLV Concentration 10-ft. Sample Line)	Chemcassette Part Number
Chlorine XPV Chlorine-3 (Cl ₂)	0.1ppm	0.060 ppm	0.050 ppm	0.250 ppm	0.500 ppm	0-5.000 ppm	0.060-0.249 ppm 0.250-0.499 ppm 0.500-0.999 ppm 1.000-5.000 ppm	120 45 30 30	<55sec (Alarm @ 0.1ppm with 0.2ppmCl ₂ gas) <22sec (Alarm @ 0.5ppm with 1.0ppm Cl ₂ gas)	1295-0565
Chlorine XPV Chlorine-3 (Cl ₂ /LL)	0.1ppm	0.030 ppm	0.010 ppm	0.050 ppm	0.100 ppm	0-1.000 ppm	0.030-0.049 ppm 0.050-0.099 ppm 0.100-0.199 ppm 0.200-1.000 ppm	120 120 90 60	<60sec (Alarm @ 0.1ppm with 0.2ppm Cl ₂ gas)	1295-0565
Diborane (B ₂ H ₆)	100 ppb	20 ppb	15 ppb	100 ppb	200 ppb	0-1000 ppb	20-99 ppb 100-199 ppb 200-299 ppb 300-1000 ppb	60 45 30 15	<40 sec	1295-0300
Diborane XP (B ₂ H ₆)	100 ppb	15 ppb	10 ppb	100 ppb	200 ppb	0-1000 ppb	15-49 ppb 50-99 ppb 100-1000 ppb	60 45 30	<40 sec	1295-0226
Diborane XP4 (B ₂ H ₆)	100 ppb	15 ppb	10 ppb	100 ppb	200 ppb	0-1000 ppb	15-49 ppb 50-99 ppb 100-1000 ppb	60 45 30	<40 sec	1257-9300
Dimethylamine (DMA)	5 ppm	0.4 ppm	0.3 ppm	5 ppm	10 ppm	0-30 ppm	0.4-2.4 ppm 2.5-4.9 ppm 5-30 ppm	120 60 30	<40 sec	1295-0221
Dimethylamine XP (DMA)	5 ppm	0.5 ppm	0.5 ppm	5.0 ppm	10.0 ppm	0-50.0 ppm	0.5-2.4 ppm 2.5-50.0 ppm	15 10	<20 sec	1295-0405

TLV - Threshold Limit Value LAL - Lowest Alarm Level LDL - Lower Detectable Limit

1. "-1" calibrations allow more stain development but will extend response times

2. Minimum Sample Time

Gas Name ¹	TLV	LAL	LDL	Default Alarm Level 1	Default Alarm Level 2	Range	Alarm Setting	Initial Analysis Period (second)	Time to 1 TLV (Alarm @ 2 TLV Concentration 10-ft. Sample Line)	Chemcassette Part Number
Dimethylamine XP4 (DMA)	5 ppm	0.5 ppm	0.5 ppm	5.0 ppm	10.0 ppm	0-50.0 ppm	0.5-2.4 ppm 2.5-50 ppm	15 10	<20 sec	1257-9309
Fluorine (F ₂)	0.1 ppm	0.1 ppm	0.06 ppm	1 ppm	2 ppm	0-10 ppm	0.1-0.9 ppm 1-10 ppm	60 30	<40 sec (Alarm @ 1ppm with 2 ppmF2 gas)	1295-0220
Fluorine XP-Cl2-II (F ₂)	0.1 ppm	0.060 ppm	0.060 ppm	1.000 ppm	2.000 ppm	0 - 10.000 ppm	0.060 -1.999 ppm 2.000 - 3.999 ppm 4.000 - 10.00 ppm	90 60 30	<110 sec (Alarm @ 0.1ppm with 0.2 ppmF2 gas) <25 sec (Alarm @ 1.0ppm with 2.0 ppmF2 gas)	1295-0560
Fluorine XP-Cl2-II (F ₂ /LL) (Low Level)	0.1 ppm	0.050 ppm	0.030 ppm	0.100 ppm	0.200 ppm	0 - 1.000 ppm	0.050-0.199 ppm 0.200-1.000 ppm	120 60	<135 sec (Alarm @ 0.1ppm with 0.2ppmF2 gas)	1295-0560
Fluorine XPV Chlorine-3 (F ₂)	0.1 ppm	0.07 ppm	0.050 ppm	1.000 ppm	2.000 ppm	0-10.000 ppm	0.060-0.999 ppm 1-1.999 ppm 2.000-3.999 ppm 4.000-10.000 ppm	120 90 60 30	<110sec (Alarm @ 0.1ppm with 0.2ppm F2 gas) <35 sec (Alarm @ 1.0ppm with 1ppm F2 gas)	1295-0565
Fluorine XPV Chlorine-3 (F ₂ /LL)	0.1 ppm	0.05 ppm	0.030 ppm	0.100 ppm	0.200 ppm	0-1.000 ppm	0.050-0.099ppm 0.100-0.199ppm 0.200-0.399ppm 0.400-1.000ppm	180 180 60 60	<155 sec (Alarm @ 0.1ppm with 0.2ppm F2 gas)	1295-0565
Germane (GeH ₄)	200 ppb	100 ppb	85 ppb	200 ppb	400 ppb	0-2000 ppb	100 - 149ppb 150 - 199ppb 200 - 399ppb 400 - 2000ppb	90 90 60 60	<87sec (Alarm @ 200ppb with 400ppb gas)	1295-0566
Germane XPV-Germane (GeH ₄)	200 ppb	100 ppb	85 ppb	200 ppb	400 ppb	0- 2000ppb	100 - 149ppb 150 - 199ppb 200 - 399ppb 400 - 2000ppb	90 90 60 60	<87sec (Alarm @ 200ppb with 400ppb gas)	1295-0564

TLV - Threshold Limit Value LAL - Lowest Alarm Level LDL - Lower Detectable Limit

1. "-1" calibrations allow more stain development but will extend response times

2. Minimum Sample Time

Gas Name ¹	TLV	LAL	LDL	Default Alarm Level 1	Default Alarm Level 2	Range	Alarm Setting	Initial Analysis Period (second)	Time to 1 TLV (Alarm @ 2 TLV Concentration 10-ft. Sample Line)	Chemcassette Part Number
Germane XP (GeH ₄)	200 ppb	100 ppb	100 ppb	200 ppb	400 ppb	0-2000 ppb	100-149 ppb 150-199 ppb 200-2000 ppb	480 360 240	<252 sec	1295-0226
Germane XP4 (GeH ₄)	200 ppb	100 ppb	100 ppb	200 ppb	400 ppb	0-2000 ppb	100-149 ppb 150-199 ppb 200-2000 ppb	480 360 240	<252 sec	1257-9300
Hydrogen Bromide (HBr)	2 ppm	0.5 ppm	0.3 ppm	2 ppm	4 ppm	0-30 ppm	0.5-2.9 ppm 3-5.9 ppm 6-8.9 ppm 9-30 ppm	45 30 15 10	<35 sec	1295-0225
Hydrogen Bromide (HBr) Low Level	2 ppm	100 ppb	50 ppb	250 ppb	500 ppb	0-2000 ppb	100-249 ppb 250-499 ppb 500-749 ppm 750-2000 ppb	240 120 60 30	<40 sec	1295-0225
Hydrogen Bromide XP (HBr)	2 ppm	0.3 ppm	0.2 ppm	2 ppm	4 ppm	0-20 ppm	0.3-1.9 ppm 2-20 ppm	45 30	<35 sec	1295-0507
Hydrogen Bromide XP4 (HBr)	2 ppm	0.3 ppm	0.2 ppm	2 ppm	4 ppm	0-20 ppm	0.3-1.9 ppm 2-20 ppm	45 30	<35 sec	1257-9310
Hydrogen Bromide XP4 (HBr) Low Level	2 ppm	30 ppb	20 ppb	200 ppb	400 ppb	0-2000 ppb	30-99 ppb 100-399 ppb 400-2000 ppb	180 120 60	<75 sec (Alarm @ 500 ppb with 1000 ppb HBr gas)	1257-9310
Hydrogen Bromide XP (HBr) Low Level	2 ppm	30 ppb	20 ppb	200 ppb	400 ppb	0-2000 ppb	30-99 ppb 100-399 ppb 400-2000 ppb	180 120 60	<75 sec (Alarm @ 500 ppb with 1000 ppb HBr gas)	1295-0507
Hydrogen Chloride (HCl)	2 ppm	0.5 ppm	0.5 ppm	2 ppm	4 ppm	0-15 ppm	0.5-9.9 ppm 10-19.9 ppm 20-50 ppm	30 20 15	<25 sec	1295-0225

TLV - Threshold Limit Value LAL - Lowest Alarm Level LDL - Lower Detectable Limit

1. "-1" calibrations allow more stain development but will extend response times

2. Minimum Sample Time

Gas Name ¹	TLV	LAL	LDL	Default Alarm Level 1	Default Alarm Level 2	Range	Alarm Setting	Initial Analysis Period (second)	Time to 1 TLV (Alarm @ 2 TLV Concentration 10-ft. Sample Line)	Chemcassette Part Number
Hydrogen Chloride (HCl) Low Level	2 ppm	100 ppb	80 ppb	250 ppb	500 ppb	0-8000 ppb	100-499 ppb 500-999 ppb 1000-2999 ppb 3000-8000 ppb	300 120 60 30	<30 sec	1295-0225
Hydrogen Chloride XP (HCl)	2 ppm	0.2 ppm	0.2 ppm	2 ppm	4 ppm	0-20 ppm	0.2-0.9 ppm 1-3.9 ppm 4-20 ppm	60 30 20	<25 sec	1295-0507
Hydrogen Chloride XP4 (HCl)	2 ppm	0.2 ppm	0.2 ppm	2 ppm	4 ppm	0-20 ppm	0.2-0.9 ppm 1-3.9 ppm 4-20 ppm	60 30 20	<25 sec	1257-9310
Hydrogen Chloride XP4 (HCl) Low Level	2 ppm	30 ppb	20 ppb	200 ppb	400 ppb	0-2000 ppb	30-199 ppb 200-399 ppb 400-2000 ppb	240 150 90	<95 sec (Alarm @ 200 ppb with 400 ppb HCl gas)	1257-9310
Hydrogen Chloride XP (HCl) Low Level	2 ppm	30 ppb	20 ppb	200 ppb	400 ppb	0-2000 ppb	30-199 ppb 200-399 ppb 400-2000 ppb	240 150 90	<95 sec (Alarm @ 200 ppb with 400 ppb HCl gas)	1295-0507
Hydrogen Cyanide (HCN)	4.7 ppm	1 ppm	0.5 ppm	4.7 ppm	9.4 ppm	0-30 ppm	1-9.9 ppm 10-19.9 ppm 20-30 ppm	30 20 15	<25 sec	1295-0222
Hydrogen Fluoride (HF)	0.5 ppm	0.4 ppm	0.4 ppm	2 ppm	4 ppm	0-30 ppm	0.4-2.9 ppm 3-5.9 ppm 6-11.9 ppm 12-30 ppm	120 60 30 15	<45 sec (Alarm @ 2ppm with 4ppmHF gas)	1295-0225
Hydrogen Fluoride XP (HF)	0.5 ppm	0.4 ppm	0.4 ppm	2 ppm	4 ppm	0-20 ppm	0.4-0.9 ppm 1-3.9 ppm 4-20 ppm	240 90 60	<50 (Alarm @ 2ppm with 4ppmHF gas)	1295-0507
Hydrogen Fluoride XP4 (HF)	0.5 ppm	0.4 ppm	0.4 ppm	2 ppm	4 ppm	0-20 ppm	0.4-0.9 ppm 1-3.9 ppm 4-20 ppm	240 90 60	<50 (Alarm @ 2ppm with 4ppmHF gas)	1257-9310

TLV - Threshold Limit Value LAL - Lowest Alarm Level LDL - Lower Detectable Limit

1. "-1" calibrations allow more stain development but will extend response times

2. Minimum Sample Time

Gas Name ¹	TLV	LAL	LDL	Default Alarm Level 1	Default Alarm Level 2	Range	Alarm Setting	Initial Analysis Period (second)	Time to 1 TLV (Alarm @ 2 TLV Concentration 10-ft. Sample Line)	Chemcassette Part Number
Hydrogen Fluoride XP (HF) Low Level	500 ppb	30 ppb	20 ppb	500 ppb	1000 ppb	0-2000 ppb*	30-99 ppb 100-199 ppb 200-399 ppb 400-2000 ppb	360 240 120 90	<95 sec (Alarm @500ppb with 1ppmHF gas)	1295-0507
Hydrogen Fluoride XP4 (HF) Low Level	500 ppb	30 ppb	20 ppb	500 ppb	1000 ppb	0-2000 ppb*	30-99 ppb 100-199 ppb 200-399 ppb 400-2000 ppb	360 240 120 90	<95 sec (Alarm @500ppb with 1ppmHF gas)	1257-9310
*Due to U.S. Government regulations, this range may be subject to restrictions requiring special licensing for certain countries outside North America. Contact Honeywell Analytics for eligibility information.										
Hydrogen Iodide (HI)	None Est.	0.2 ppm	0.1 ppm	3 ppm	6 ppm	0-25 ppm	0.2-1.4 ppm 1.5-25 ppm	240 60	<30 sec	1295-0225
Hydrogen Selenide (H ₂ Se)	50 ppb	8 ppb	6 ppb	50 ppb	100 ppb	0-500 ppb	8-49 ppb 50-99 ppb 100-500 ppb	180 120 60	<55 sec	1295-0300
Hydrogen Selenide XP (H ₂ Se)	50 ppb	8 ppb	6 ppb	50 ppb	100 ppb	0-500 ppb	8-49 ppb 50-99 ppb 100-500 ppb	180 120 60	<45 sec	1295-0226
Hydrogen Selenide XP4 (H ₂ Se)	50 ppb	8 ppb	6 ppb	50 ppb	100 ppb	0-500 ppb	8-49 ppb 50-99 ppb 100-500 ppb	180 120 60	<45 sec	1257-9300
Hydrogen Sulfide (H ₂ S)	1 ppm	1 ppm	0.5 ppm	10 ppm	20 ppm	0-100 ppm	1-9.9 ppm 10-19.9 ppm 20-39.9 ppm 40-100 ppm	30 15 10 10	<20 sec (Alarm @ 10 ppm with 20 ppm H ₂ S gas)	1295-0223
Hydrogen Sulfide (H ₂ S) (Hydrides)	1 ppm	2 ppm	1 ppm	10 ppm	20 ppm	0-50 ppm	2-9.9 ppm 10-19.9 ppm 20-39.9 ppm 40-50 ppm	60 45 30 15	<20 sec (Alarm @ 10 ppm with 20 ppm H ₂ S gas)	1295-0300

TLV - Threshold Limit Value LAL - Lowest Alarm Level LDL - Lower Detectable Limit

1. "-1" calibrations allow more stain development but will extend response times

2. Minimum Sample Time

Gas Name ¹	TLV	LAL	LDL	Default Alarm Level 1	Default Alarm Level 2	Range	Alarm Setting	Initial Analysis Period (second)	Time to 1 TLV (Alarm @ 2 TLV Concentration 10-ft. Sample Line)	Chemcassette Part Number
Hydrogen Sulfide (H ₂ S) Low Level	1 ppm	10 ppb	8 ppb	250 ppb	500 ppb	0-2000 ppb	10-99 ppb 100-499 ppb 500-999 ppb 1000-2000 ppb	480 240 120 60	<40 sec (Alarm @ 500 ppb with 1 ppm H ₂ S gas)	1295-0223
Hydrogen Sulfide XP (H ₂ S)	1 ppm	1 ppm	0.5 ppm	10 ppm	20 ppm	0-50 ppm	1-4.9 ppm 5-9.9 ppm 10-50 ppm	30 15 10	<20 sec (Alarm @ 10 ppm w/ 20 ppm H ₂ S gas)	1295-0226
Hydrogen Sulfide XP4 (H ₂ S)	1 ppm	1 ppm	0.5 ppm	10 ppm	20 ppm	0-50 ppm	1-4.9 ppm 5-9.9 ppm 10-50 ppm	30 15 10	<20 sec (Alarm @ 10 ppm with 20 ppm H ₂ S gas)	1257-9300
Hydrogen Sulfide XP (H ₂ S) Low Level	1 ppm	20 ppb	15 ppb	500 ppb	1000 ppb	0-2000 ppb	20-99 ppb 100-199 ppb 200-399 ppb 400-2000 ppb	120 60 30 15	<25sec (Alarm @ 500 ppb with 1000 ppb H ₂ S gas)	1295-0226
Hydrogen Sulfide XP4 (H ₂ S) Low Level	1 ppm	20 ppb	15 ppb	500 ppb	1000 ppb	0-2000 ppb	20-99 ppb 100-199 ppb 200-399 ppb 400-2000 ppb	120 60 30 15	<15sec (Alarm @ 500 ppb with 1000 ppb H ₂ S gas)	1257-9300
Nitrogen Dioxide (NO ₂)	0.2 ppm	0.5 ppm	0.3 ppm	3 ppm	6 ppm	0-30 ppm	0.5-8.9 ppm 9-30 ppm	240 120	<130 sec (Alarm @ 3ppm with 6ppm NO ₂ gas)	1295-0220
Nitrogen Trifluoride (NF ₃) Pyrolyzer Only	10 ppm	1 ppm	1 ppm	10ppm	20 ppm	0-50 ppm	1-9.9 ppm 10-19.9 ppm 20-39.9 ppm 40-50 ppm	40 20 10 10	<70 sec	1295-0225
Nitrogen Trifluoride XP (NF ₃) Pyrolyzer Only	10 ppm	1 ppm	1 ppm	10 ppm	20 ppm	0-50 ppm	1-9.9 ppm 10-19.9 ppm 20-39.9 ppm 40-50 ppm	30 15 10 10	<20 sec	1295-0507

TLV - Threshold Limit Value LAL - Lowest Alarm Level LDL - Lower Detectable Limit

1. "-1" calibrations allow more stain development but will extend response times

2. Minimum Sample Time

Gas Name ¹	TLV	LAL	LDL	Default Alarm Level 1	Default Alarm Level 2	Range	Alarm Setting	Initial Analysis Period (second)	Time to 1 TLV (Alarm @ 2 TLV Concentration 10-ft. Sample Line)	Chemcassette Part Number
Nitrogen Trifluoride XP4 (NF ₃) Pyrolyzer Only	10 ppm	1 ppm	1 ppm	10 ppm	20 ppm	0-50 ppm	1-9.9 ppm 10-19.9 ppm 20-39.9 ppm 40-50 ppm	30 15 10 10	<20 sec	1257-9310
Phosgene XP (COCl ₂)	100 ppb	10 ppb	7 ppb	100 ppb	200 ppb	0-1000 ppb	10-49 ppb 50-99 ppb 100-199 ppb 200-1000 ppb	60 45 30 15	<25 sec	1295-0228
Phosgene XP (COCl ₂) High Range	100 ppb	10 ppb	7 ppb	100 ppb	200 ppb	0-4000 ppb	10-49 ppb 50-99 ppb 100-199 ppb 200-4000 ppb	60 45 30 15	<25 sec	1295-0228
Phosgene XP4 (COCl ₂)	100 ppb	10 ppb	7 ppb	100 ppb	200 ppb	0-1000 ppb	10-49 ppb 50-99 ppb 100-199 ppb 200-1000 ppb	60 45 30 15	<25 sec	1257-9307
Phosgene XP4 (COCl ₂) High Range	100 ppb	10 ppb	7 ppb	100 ppb	200 ppb	0-4000 ppb	10-49 ppb 50-99 ppb 100-199 ppb 200-4000 ppb	60 45 30 15	<25 sec	1257-9307
Phosphine (PH ₃)	50 ppb	5 ppb	5 ppb	300 ppb	600 ppb	0-3000 ppb	5-3000 ppb	15	<20 sec (Alarm @ 300ppb with 600ppbPH3 gas)	1295-0300
Phosphine XP (PH ₃)	50 ppb	5 ppb	5 ppb	300 ppb	600 ppb	0-3000 ppb	5-3000 ppb	15	<20 sec (Alarm @ 300ppb with 600ppbPH3 gas)	1295-0226
Phosphine XP4 (PH ₃)	50 ppb	5 ppb	5 ppb	300 ppb	600 ppb	0-3000 ppb	5-3000 ppb	15	<20 sec (Alarm @ 300ppb with 600ppbPH3 gas)	1257-9300

TLV - Threshold Limit Value LAL - Lowest Alarm Level LDL - Lower Detectable Limit

1. "-1" calibrations allow more stain development but will extend response times
2. Minimum Sample Time

Gas Name ¹	TLV	LAL	LDL	Default Alarm Level 1	Default Alarm Level 2	Range	Alarm Setting	Initial Analysis Period (second)	Time to 1 TLV (Alarm @ 2 TLV Concentration 10-ft. Sample Line)	Chemcassette Part Number
Silane (SiH ₄)	5 ppm	1 ppm	0.5 ppm	5 ppm	10 ppm	0-50 ppm	1-4.9 ppm 5-9.9 ppm 10-19.9 ppm 20-50 ppm	60 45 30 15	<35 sec	1295-0300
Silane-M XP (SiH ₄ -M)	5 ppm	0.06 ppm	0.05 ppm	2.5 ppm	5.0 ppm	0-15 ppm	0.05-2.49 ppm 2.5-4.99 ppm 5-9.99 ppm 10-15 ppm	180 60 45 30	<20 sec	1295-0226
Silane-M XP4 (SiH ₄ -M)	5 ppm	0.06 ppm	0.05 ppm	2.5 ppm	5.0 ppm	0-15 ppm	0.05-2.49 ppm 2.5-4.99 ppm 5-9.99 ppm 10-15 ppm	180 60 45 30	<20 sec	1257-9300
Silane XP (SiH ₄)	5 ppm	0.5 ppm	0.3 ppm	5 ppm	10 ppm	0-50 ppm	0.5-4.9 ppm 5-9.9 ppm 10-19.9 ppm 20-50 ppm	60 45 30 15	<30 sec	1295-0226
Silane XP (SiH ₄) Low Level	5 ppm	50 ppb	50 ppb	250 ppb	500 ppb	0-5000 ppb	50-249 ppb 250-499 ppb 500-999 ppb 1000-5000 ppb	360 240 120 60	<100 sec (Alarm @ 500 ppb with 1 ppm SiH ₄ gas)	1295-0226
Silane XP4 (SiH ₄)	5 ppm	0.5 ppm	0.3 ppm	5 ppm	10 ppm	0-50 ppm	0.5-4.9 ppm 5-9.9 ppm 10-19.9 ppm 20-50 ppm	60 45 30 15	<30 sec	1257-9300
Silane XP4 (SiH ₄) Low Level	5 ppm	50 ppb	50 ppb	250 ppb	500 ppb	0-5000 ppb	50-249 ppb 250-499 ppb 500-999 ppb 1000-5000 ppb	360 240 120 60	<100 sec (Alarm @ 500 ppb with 1000 ppb SiH ₄ gas)	1257-9300
Sulfur Dioxide (SO ₂)	250 ppb	30 ppb	25 ppb	250 ppb	500 ppb	0-2500 ppb	30-249 ppb 250-2500 ppb	60 30	<30 sec	1295-0552
Tertiary Butyl Arsilane (TBA)	0.5 mg/m ³ as As (OSHA)	15 ppb	12 ppb	50 ppb	100 ppb	0-500 ppb	15-49 ppb 50-99 ppb 100-199 ppb 200-500 ppb	120 60 30 15	<42 sec	1295-0300

TLV - Threshold Limit Value LAL - Lowest Alarm Level LDL - Lower Detectable Limit

1. "-1" calibrations allow more stain development but will extend response times

2. Minimum Sample Time

Gas Name ¹	TLV	LAL	LDL	Default Alarm Level 1	Default Alarm Level 2	Range	Alarm Setting	Initial Analysis Period (second)	Time to 1 TLV (Alarm @ 2 TLV Concentration 10-ft. Sample Line)	Chemcassette Part Number
Tertiary Butyl Arsine XP (TBA)	0.5 mg/m ³ as As (OSHA)	15 ppb	12 ppb	50 ppb	100 ppb	0-500 ppb	15-24 ppb 25-49 ppb 50-99 ppb 100-500 ppb	120 60 30 15	<45 sec (Alarm @ 2 TLV Concentration 10-ft. Sample Line)	1295-0226
Tertiary Butyl Arsine XP4 (TBA)	0.5 mg/m ³ as As (OSHA)	15 ppb	12 ppb	50 ppb	100 ppb	0-500 ppb	15-24 ppb 25-49 ppb 50-99 ppb 100-500 ppb	120 60 30 15	<45 sec (Alarm @ 50 ppb with 100 ppb TBA gas)	1257-9300
Tertiary Butyl Phosphine XP (TBP)	None Est	80 ppb	75 ppb	300 ppb	600 ppb	0-2000 ppb	80-149 ppb 150-299 ppb 300-599 ppb 600-2000 ppb	240 120 60 30	<70 sec (Alarm @ 300 ppb with 600 ppb TBP gas)	1295-0226
Tertiary Butyl Phosphine XP4 (TBP)	None Est.	80 ppb	75 ppb	300 ppb	600 ppb	0-2000 ppb	80-149 ppb 150-299 ppb 300-599 ppb 600-2000 ppb	240 120 60 30	<70 sec (Alarm @ 300 ppb with 600 ppb TBP gas)	1257-9300
Tetrakis Dimethylamino Titanium XP (TDMAT)	None Est.	0.1 ppm	0.1 ppm	1.0 ppm	2.0 ppm	0-10.0 ppm	0.1-0.4 ppm 0.5-10.0 ppm	15 10	<20 sec	1295-0405
Tetrakis Dimethylamino Titanium XP4 (TDMAT)	Not Est.	0.1 ppm	0.1 ppm	1.0 ppm	2.0 ppm	0-10.0 ppm	0.1-0.4 ppm 0.5-10.0 ppm	15 10	<20 sec	1257-9309

TLV - Threshold Limit Value LAL - Lowest Alarm Level LDL - Lower Detectable Limit

1. "-1" calibrations allow more stain development but will extend response times

2. Minimum Sample Time

A Replacement and Consumable Items

A.1 Consumables

A.1.1 Chemcassettes®

Aliphatic Amines NH3	1295-0221
Cl2-Iii Oxidizers	1295-0224
Fluorine	1295-0220
Hydrides	1295-0300
Hydrogen Cyanide	1295-0222
Hydrogen Sulfide	1295-0223
Mineral Acids	1295-0225
XP Chlorine (Extended Play)	1295-0227
XP Hydrides (Extended Play)	1295-0226
XP Phosgene (Extended Play)	1295-0228
XP Amines/Ammonia (Extended Play)	1295-0405
XP Mineral Acids (Extended Play)	1295-0507
XP4-V Chlorine	1257-9308
XP4-V Hydrides	1257-9300
XP4-V Phosgene	1257-9307
XP4-V Amines/Ammonia	1257-9309
XP4-V Mineral Acids	1257-9310

A.1.2 End of Line Particulate Sample Filters

See [Appendix A Specifications](#).

For non-corrosive gases	780248
For corrosive gases	1830-0055
Replacement membrane, for corrosives (pk/100)	0235-1072
For corrosive gases	1991-0147

A.1.3 Analyzer Filters

Acid Scrubber Filter	710235
Particulate Filter	780248
Analyzer Internal Valve Filter Kit	1295K0366

A.1.4 Pyrolyzer Filters

Freon Filter (package of 4)	1874-0139
-----------------------------	-----------

A.1.5 Rack Filters

Glass Fiber Filter (pump module)	0235-1186
----------------------------------	-----------

A.2 Printed Circuit Boards

A.2.1 Pyrolyzers

AC Line Filter	1874A0248
Temperature Controller	1295A0466

A.2.2 All Analyzers

RFID PCB Assembly	1295A0412
-------------------	-----------

A.2.3 Power Distribution Module

Connector PCB	1295A0420
Switch PCB	1295A0422

A.3 Components

A.3.1 All Analyzers

Proportional Valve	0235-1279
Closed Loop Optics Block Assembly (4 points)	1295A0607
Dual Optics Cover	1295-0218
Stepper Motor Assembly (tape advance)	1295A0095
Encoder Assembly	1295A0094
Encoder Brake Assembly	1295A0091
Chemcassette Sprocket	1874-0322
Tape Guide	1295-0026
Microtube Assembly (one point)	874272
2 Way N.C. Valve	874173
Aluminum Gate Actuator Kit	1874K0407
Gate Motor Assembly	1295A0096
0.015" Orifice Kit (8 pieces)	1290K0009
24VDC Fan Assembly	1295A0239
Ejector Solenoid	0100-2002

A.3.2 Pyrolyzers

Microtube Assembly (one point, for pyrolyzer Pts 1 - 4)	1295A0235
Microtube Assembly (one point, for pyrolyzer Pts 5 - 8)	1295A0236
Check Valve	0235-1157
Pyrolyzer Fan Assembly	1295A0238
Heater Kit (230 Volt, 2 required)	1295K0485

A.3.3 Rack Systems

0.250 x 0.190 x 1000ft FEP tubing	0235-0109
0.250 x 0.156 x 400ft FEP tubing	0235-0157
0.500 x 0.375 x 50ft	
Polyethylene tubing	102642
Fan, 24VDC	0220-0023
Ethernet Switch (may be different than the one installed in the unit)	0185-0086
LCD Display w/Touch Screen	Call Service
PLC Power Supply	0185-0048
PLC Processor Module	0185-0049
PLC 8 Position Relay Module (Isolated)	0185-0090
PLC 16 Position Relay Module (Non-Isolated)	0185-0053
DH485/RS232 Interface Module	0185-0050
DH485 Link Coupler	0185-0052
Advanced Interface Converter	0185-0051
All other PLC Cards	Call Service
Sample Inlet 1/4" Tube Fitting	1295-0352
Pyrolyzer Isolation Transformer	1290A0027
Sample Inlet 1/4" Tube Fitting	1295-0427
2U i3 Computer System	Call Service
Replacement Hard Disk Drive (SATA)	0185-0107

A.3.3.1 Power Distribution Module

Power Distribution Module (complete)	1295A0413
--------------------------------------	-----------

Hot Swappable 24VDC Power Supply	0060-0020
----------------------------------	-----------

A.3.4 Pump Modules

Pump Assy, 220/230VAC	1290A0059
Pump Assy, 110VAC	1290A0058
Pump Rebuild Kit	0235-0236
Pump Stem and O-Ring	0235-1212
Neoprene Isolation Mount	0950-1061
Thermal Switch (170F)	0170-0082
Fan, 24VDC	0220-0023
Differential Pressure Switch	0050-0039

**A Optional Relay
Specifications**

A.1 Relay Output Contacts

Relay output contacts: via PLC, normally open (form A). Available in 32 and 64 contacts, both are user configurable.

A.2 Relay Contact Ratings

- 0.1 to 2.0 Amps
- 5-24 VDC or
- 5-120 VAC

The alarm relay has a minimum load requirement of greater than 5 volts and 10 mA. For reliable relay operation, ensure the alarm circuit meets these requirements.

Maximum Volts		Amperes ¹		Amperes Continuous ²	Volt-Amperes	
		Make	Break		Make	Break
AC	240 VAC	7.5A	0.75A	25A	1800VA	180VA
	120 VAC	15A	1.5A			
DC	125 VDC	0.22A3		1.0A	28VA	
	24 VDC	1.2A3				
AC	240 VAC	15A	1.5A	50A	3600VA	360VA
	120 VAC	30A	3.0A			
DC	125 VDC	0.22A3		1.0A	28VA	
	24 VDC	1.2A3				

(1) Connecting surge suppressors across your external load will extend the life of SLC 500 relay contacts. For recommended surge suppressor when switching AC inductive loads, consult the SLC 500 Modular Hardware Style Installation and Operation User Manual (Publication 1747-6.2) or the SLC 500 Fixed Hardware Style Installation and Operation User Manual (Publication 1747-6.2.1). Recommended surge suppression for switching 24 VDC inductive loads is a 1N4004 diode reverse wired across the load.

(2) The continuous current per module must be limited so the module power does not exceed 1440 VA.

(3) For DC voltage applications, the make/break ampere rating for relay contacts can be determined by dividing the 28 VA by the applied DC voltage. For example, $28 \text{ VA} / 48 \text{ VDC} = 0.58\text{A}$. For DC voltage applications less than 14V, the make/break ratings for relay contacts cannot exceed 2A. RTB = Removable Terminal Block.

Table A-1. Relay Contact Ratings for 1746-OW16

For more information see Allen-Bradley publication 1746-2.35. This can be found at: http://literature.rockwellautomation.com/idc/groups/literature/documents/td/1746-td006_-en-p.pdf.

A.3 Default Relay Assignments

Note:

User is required to setup the relay configuration. The default settings do not include any faults or alarm levels.

A.3.1 Introduction

By default, the Vertex M reserves the first 2 contacts for faults. You may associate any remaining relay contacts with points in any analyzer. See [Section 3.6.3 Set Analyzer Window](#) for procedures to associate relay contacts with alarms.

A.3.2 Main PLC

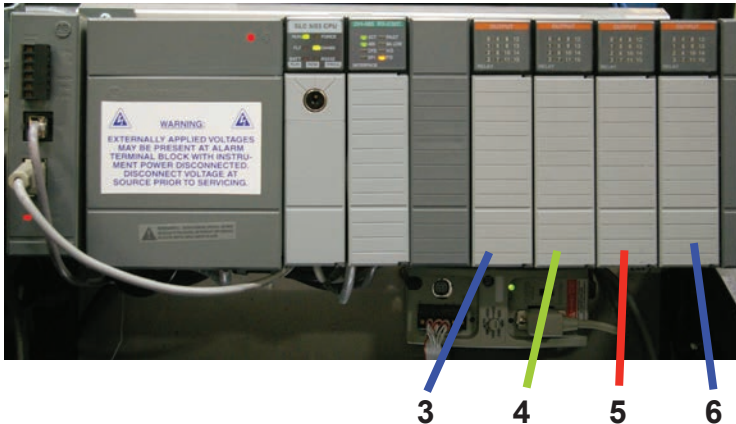

A.3.3 Terminal Assignment of 1746-OW16 Relay Module

Option Part Number: 1290-0076

Individual Relay Card Part Number: 0185-0053

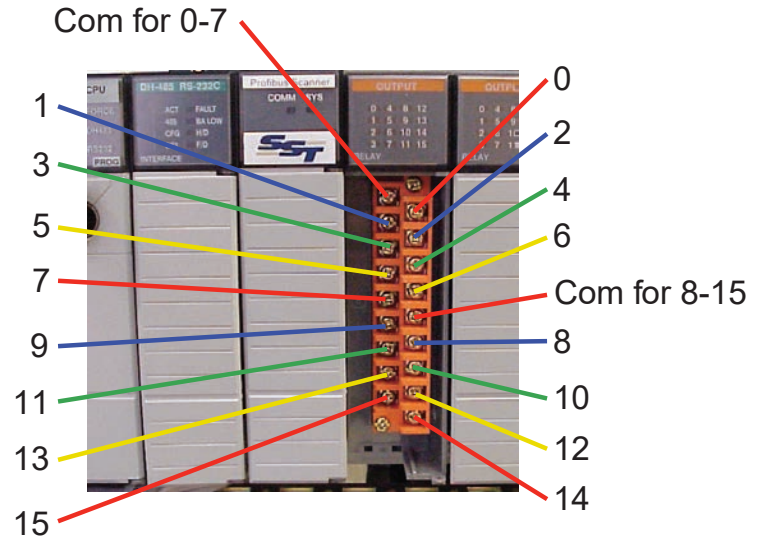

A.3.4 Terminal Assignment of 1746-OX8 Relay Module

Option Part Number: 1290-0077

Individual Relay Card Part Number: 0185-0090



**A Network Interface
and Options**

A.1 Network Interface and Options

Network interface options currently available on Vertex M are:

Standard:

- OLE for Process Control (OPC) Interface. See [Section A.2 OLE for Process Control \(OPC\) Interface](#).

Options:

The Vertex M can be fitted with any one of six optional fieldbus interfaces as summarized in Table F-1.

Table A-1. Vertex M Fieldbus Options

Protocol Name	Honeywell Analytics part number	Section
Profibus - DP	1295-0275	F5
DeviceNet	1295-0329	F6
ControlNet	1295-0394*	F7
DF1	1295-0343	F8
ModBus Plus	1295-0330	F9
LonWorks	1295-0328	F10
Modbus/TCP	1295-0520	F11
Ethernet/CIP	1295-0519	F12

* Part Number obsolete



CAUTION

Do not install routers between the optional PLC fieldbus networks and the internet. These networks are not designed to resist cyberattack so their cabling must have rigorous physical isolation from malicious traffic.

Optional Remote Display Software.

The Vertex M can be ordered with an optional remote display capability as described in [Section A.13 Vertex M Remote Display Setup](#)

A.2 OLE for Process Control (OPC) Interface

The primary method of alarm and fault annunciation used by the Vertex M Gas analyzer relies on the Allen Bradley SLC500 PLC system installed in the base enclosure using optional fieldbusses or contact closure.

A secondary method for annunciation and data access is available via the Ethernet network port on the Vertex M Data Acquisition System using OPC. Concentration data as well as alarm and fault status are available through this interface. The OPC drivers are automatically initialized at startup of the application, enabling the Vertex M to act as an OPC Server. The user may connect to the Network interface Cards RJ45 Port at the rear of the data Acquisition System See [Section 1.2.7 Data Acquisition Computer \(rear\)](#).

The Vertex M contains 1331 OPC tags as listed in [Table A-3. Tag Names](#). Many of these are present for historical reasons and have low utility for an external HMI system. The column “recommended for most HMI systems” is provided to help separate the useful from the obscure. The number of recommended tags is 317.



OPC via Ethernet is not recommended for the primary safety system notification.



Tunnel OPC communication outside the Vertex M rack using secure software such as KepWare OPC Connectivity Suite or Matrikon OPC Tunneller. OPC communication among Microsoft Windows computers is not highly resistant to cyberattack.

A.2.1 Setting Up an OPC Client Application

To request data from Vertex M your OPC Client application will need to include the following information. More information on OPC and client application is available at www.opcfoundation.org.

Table A-2. Additional OPC Client information

Server	Honeywell.VertexOPCServerDA.1
Type	Local
Server Computer Name or Address	Enter the Computer Name of the Vertex M Data acquisition PC from Settings, Control Panel, System, Network Identification. Typically: Vertex M_291-####, with the # being the 4 digit serial number.
Access Path	Project name. You can leave this blank. If you do specify a name, use the name of the open project.
Update Rate	A period in seconds.
Item	Tag name. Whether to specify an item depends on the client application.

Table A-3. Tag Names

Folder	Tag Count	Recommended for most HMI systems	Tag Name Format	Value Interpretation / Description
Alarm	72		##_1	Integer, 1 byte long Status 0 = No alarm 1 = Warning 2 = Alarm 1 3 = Alarm 2 Always nonlatching
AlarmLatched	72	Y	Ch###	Integer, 1 byte long Status 0 = No alarm 1 = Warning 2 = Alarm 1 3 = Alarm 2 Latching if and only if rack configured for latching alarms as described in Section 3.7 .
CommStatus	9		CmmFlag#	String, "N/A" (unconfigured) , "NO" (not communicating) or "YES" (correct)
Diagnostics	9		Az#CCDaysLeft	Float32, Equivalent to "Chemcassette Tape Left" as displayed in Diagnostic / Analyzer Info
PyroTemp	72		##	Float32 Equivalent to "Pyrolyzer Temperature" as displayed in Diagnostics / Analyzer Info
Fault				

Table F-3. Tag Names (continued)

Folder	Tag Count	Recommended for most HMI systems	Tag Name Format	Value Interpretation / Description
LFault	72		Pt##	String containing the fault number and long fault description for the most recent Pt fault. The contents of this item, the corresponding short description item and the corresponding timestamp will be based on the following priority: 1) Most severe point-specific fault 2) If no point-specific fault, the most severe analyzer fault 3) If no fault, a blank string
	9		Az#	String containing the fault number and long fault description for the most recent analyzer fault. The contents of this item, the corresponding short description item, the corresponding timestamp item will be based on the following priority: 1) Most severe analyzer fault 2) Most severe simulated fault 3) If no fault, a blank string
	1		HMI	String containing the fault number and fault description for the most recent HMI fault. The contents of this item, the corresponding short description item and the corresponding timestamp item will be based on the following priority: 1) Most severe HMI fault 2) If no fault, a blank string
	1		PLC	String containing the fault number and long fault description for the most recent PLC fault. The contents of this item, the corresponding short description item and the corresponding timestamp item will be based on the following priority: 1 = Most severe PLC fault 2 = If no fault, a blank string
SFault	72		Pt##	String with short description of fault associated with Fault\LFault\Pt##
	9		Az#	String with short description of fault associated with Fault\LFault\Az#
	1		HMI	String with short description of fault associated with Fault\LFault\HMI
	1		PLC	String with short description of fault associated with Fault\LFault\PLC
TimeStamp	72		Pt##	String representation of timestamp of fault creation associated with Fault\LFault\Pt##.
	9		Az#	String representation of timestamp of fault creation associated with Fault\LFault\Az#.
	1		HMI	String representation of timestamp of fault creation associated with Fault\LFault\HMI
	1		PLC	String representation of timestamp of fault creation associated with Fault\LFault\PLC

Table F-3. Tag Names (continued)

Folder	Tag Count	Recommended for most HMI systems	Tag Name Format	Value Interpretation / Description
Flow Control				
DtoA	72		##	For HA internal use only
Flow	72		##	Integer sample point flow in cc/minute
Pressure	72		##	Float32, point sample pressure in inches Hg, (usually approx. -1.0)
Slope	72		##	Float32 for HA internal use only
System	9		#	Float32, vacuum pump pressure in inches Hg, as measured by each analyzer (usually -13.0)
	9		Az#	String in form "Az x-y"
	72		Pt##Flow10	Float32 for HA internal use only
	72		Pt##Flow90	Float32 for HA internal use only
GasCon	72	Y	##1	Float32; Gas concentration in ppm, ppb, mg/m3 as configured.
Main	0			
Ana_Fault	9	Y	#	Unsigned integer Status 0 = No fault 1 = Maintenance Fault 2 = Instrument Fault 3 = Both Reports only analyzer-wide faults. Does not indicate the presence of a point-specific fault
PLC	9	Y	#	Unsigned integer Status 0 = No fault 1 = Maintenance Fault 2 = Instrument Fault 3 = Both Reports faults from either analyzer or point

Table F-3. Tag Names (continued)

Folder	Tag Count	Recommended for most HMI systems	Tag Name Format	Value Interpretation / Description
Fault	72	Y	##	Unsigned integer Status 0 = No fault 1 = Maintenance Fault 2 = Instrument Fault 3 = Both Reports only point-specific faults
	1	Y	HMI	Unsigned integer Status 0 = No fault 1 = Maintenance Fault 2 = Instrument Fault 3 = Both Reports only faults originating in the HMI
	1	Y	PLC	Unsigned integer, Indicates the presence of a fault for the PLC Status 0 = No fault 1 = Maintenance Fault 2 = Instrument Fault 3 = Both Indicates the presence of a fault originating in the PLC.
MonStat	72	Y	##	Integer, 1 byte long, interpreted as a bitmask. This reports status for point as listed below: bits 0-2 - run alarm disable status as a 3-bit integer 0 = no data 1 = Point enabled 2 = RunTimeAlarmDisable Relays only 3 = RunTimeAlarmDisable Full (No gas events) 4 = RunTimePointDisable 5 = Point disabled by configuration bits 3-4 - for HA use only bit 5 -- maintenance fault exists bit 6 -- monitor fault exists bit 7 -- for HA use only

Table F-3. Tag Names (continued)

Folder	Tag Count	Recommended for most HMI systems	Tag Name Format	Value Interpretation / Description
Maintenance	0			
CFilter	9		Az#FiltDaysLeft	Integer, number of days until filters should be changed, equivalent to "Filter Left" as displayed in Diagnostics/Analyzer Info.
Reset	0			
Monitor	9	Y	Az#	Integer monitoring state for entire analyzer , see table below 0 = Idle 1 = Pyrolyzer Warmup 2 = Monitoring 3 = Loading Chemcassette 4 = Loading new program 5 = Loading new configuration 6 = Flow auto-balance 7 = Performing Line Integrity Test
SGas_Name	72		##_1	String gas name abbreviation, e.g. "AsH3"
Unit	72		##_1	String, either "ppm" "ppb" or "mg/m3"

Note:

The Vertex M uses the same OPC server as the Vertex. Thus numerous OPC tags exist for non-existent analyzers. Tags for points greater than 24 or analyzers greater than 3 are not populated and invalid.

A.3 Data Values Common to Fieldbus Networks

All six optional fieldbus networks report alarm, fault and concentration information.

A.3.1 Alarms and Faults

The alarm status of each point is reported as a single byte. The meaning of that byte is as listed in [Table A-4](#). Similarly, the fault status of each analyzer is reported as a single byte. The meaning of the fault byte is listed in [Table A-4](#).

Table A-4. Alarm and Fault Interpretations

Alarm/ Fault value	LonWorks SNVT_lev_ disc value	Alarm Interpretation	Fault Interpretation
0	ST_OFF	No Gas	No Fault
1	ST_LOW	Warning of non-zero concentration below Alarm Level 1	Maintenance Fault Present
2	ST_MED	Alarm Level 1 Exceeded	Instrument Fault Present
3	ST_HIGH	Alarm Level 2 Exceeded	Both Faults Present

A.3.2 Concentrations

Finally, the concentration information is reported as one 16-bit word for each point as shown in [Table A-5](#).

Table A-5. Interpretation of Concentration Values

Value	Description
0	Analyzer not present
3120	Instrument Fault exists (only if configured)
6241 to 31206	Normalized concentration from zero to the 20 mA full scale value as set in the point configuration.

Fault status can be superimposed over the concentration information in a manner similar to legacy 4-20 mA analog outputs. The output will drop below nominal if an instrument fault exists. However, indication of faults via the concentration output is disabled by default. It can be turned on in the configuration profile as shown in [Figure A-1](#). For details see [Section 3.6 Configuration Utility](#).

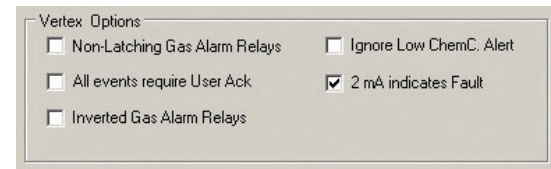

Figure A-1. Configuration Profile

If the concentration is non-zero and a fault exists, the concentration value will take priority and be reported. It is not possible to detect the existence of maintenance faults from the concentration outputs.

Unlike previous Honeywell Analytics products, the full-scale value of the concentration output is not equal to the full scale value of the gas table by default. Instead the full scale (31206 count) level defaults to twice the threshold limit value (TLV). Therefore an output of 12482 counts corresponds to a gas concentration of 0.5 TLV and 18723 counts corresponds to 1.0 TLV by default. This can be altered by editing the configuration profile as shown in [Figure A-2](#).

<input checked="" type="checkbox"/> Warning Enabled		
<input checked="" type="checkbox"/> Alarm L1	25	ppb
<input checked="" type="checkbox"/> Alarm L2	50	ppb
<input type="checkbox"/> Log never	5	ppb
<input checked="" type="checkbox"/> PLC F/S Conc.	100	ppb

Figure A-2. Configuration Profile

For more information on the configuration profile see [Section 3.6.4 Configure Point](#).

If the concentration data is to be used only for visualization and datalogging, it may be more convenient to capture this information through OPC. See [Section A.2 OLE for Process Control \(OPC\) Interface](#). This avoids the requirement of scaling the value to get actual concentration. The concentration is available through the highly-reliable fieldbus for those customers who wish to make shutdown decisions based on concentrations instead of alarm levels.

A.3.3 Heartbeat

A heartbeat counter is provided with some of the fieldbuses in word 40. This increments every second to confirm that the internal PLC is running and that communications is working. External equipment communicating with the Vertex M via Ethernet/CIP, LonWorks or Profibus must verify that this value is changing to be certain that the PLC is operating.

Each optional fieldbus interface is implemented using commercial communications modules connected to the internal PLC. In the Vertex M the modules function as slaves only, although the hardware may be capable of acting as scanners or masters when installed elsewhere.

A.4 Data Map

Five of the optional fieldbusses (all except LonWorks) report the status of the Vertex M in the same 122 word (244 byte) format which is listed in Table F-5. If concentration information is not needed, only the first 41 words must be read. This significantly reduces the consumption of scanner memory. For Ethernet/CIP, see [Table A-10](#).

Table A-6. Fieldbus Data Addresses (Except LonWorks)

Word Address	Hi Byte	Lo Byte
0	Pt 1-1-1 Alm	Pt 1-1-2 Alm
1	Pt 1-1-3 Alm	Pt 1-1-4 Alm
2	Pt 1-1-5 Alm	Pt 1-1-6 Alm
3	Pt 1-1-7 Alm	Pt 1-1-8 Alm
4	Pt 1-2-1 Alm	Pt 1-2-2 Alm
5	Pt 1-2-3 Alm	Pt 1-2-4 Alm
6	Pt 1-2-5 Alm	Pt 1-2-6 Alm
7	Pt 1-2-7 Alm	Pt 1-2-8 Alm
8	Pt 1-3-1 Alm	Pt 1-3-2 Alm
9	Pt 1-3-3 Alm	Pt 1-3-4 Alm
10	Pt 1-3-5 Alm	Pt 1-3-6 Alm
11	Pt 1-3-7 Alm	Pt 1-3-8 Alm
36	Az 1-1 Flt	Az 1-2 Flt
37	Az 1-3 Flt	

Table F-6. Fieldbus Data Addresses (Except LonWorks)
continued

Word	Address	Word	Address
41	undefined	57	Pt 1-1-8 Conc
42	undefined	58	Pt 1-2-1 Conc
43	undefined	59	Pt 1-2-2 Conc
44	undefined	60	Pt 1-2-3 Conc
45	undefined	61	Pt 1-2-4 Conc
46	undefined	62	Pt 1-2-5 Conc
47	undefined	63	Pt 1-2-6 Conc
48	undefined	64	Pt 1-2-7 Conc
49	undefined	65	Pt 1-2-8 Conc
50	Pt 1-1-1 Conc	66	Pt 1-3-1 Conc
51	Pt 1-1-2 Conc	67	Pt 1-3-2 Conc
52	Pt 1-1-3 Conc	68	Pt 1-3-3 Conc
53	Pt 1-1-4 Conc	69	Pt 1-3-4 Conc
54	Pt 1-1-5 Conc	70	Pt 1-3-5 Conc
55	Pt 1-1-6 Conc	71	Pt 1-3-6 Conc
56	Pt 1-1-7 Conc	72	Pt 1-3-7 Conc
		73	Pt 1-3-8 Conc

A.5 Profibus Option (P/N 1295-275)

Profibus is a vendor-independent, open fieldbus standard for a wide range of applications in manufacturing and process automation. Vendor independence and openness are ensured by the international standards EN 50170, EN 50254 and IEC 61158. Profibus allows communication between devices of different manufacturers without any special interface adjustment. Profibus can be used for both high-speed time critical applications and complex communication tasks. Use of special Profibus media is required.

For more information about Profibus, see www.profibus.com. Technical information on the Woodhead Connectivity / SST model

SST-PFB-SLC module which is used in the Vertex M is available from <http://www.woodhead.com/products/automation/networkinterface/PLCBackplaneModules/>.

The data map used by the Profibus interface is shown in [Table A-5](#). The interpretation of the data is in [Table A-3](#) and [Table A-4](#). The network management tool will need a .GSE file to describe every slave on the network. The vertex.gse file can be copied from any Vertex M at c:\hmi\Profibus\vertex.gse.

A.5.1 Termination

The Profibus adapter PCB assembly shown in Figure F-3 facilitates using standard large Profibus connectors without creating mechanical interferences with the back panel of the Vertex M rack. Additionally, this functions as a Profibus terminator if JP1 through JP3 are shorted. If termination is not desired then JP1 through JP3 should be cut as shown. This is Honeywell Analytics part number 1295A0372.

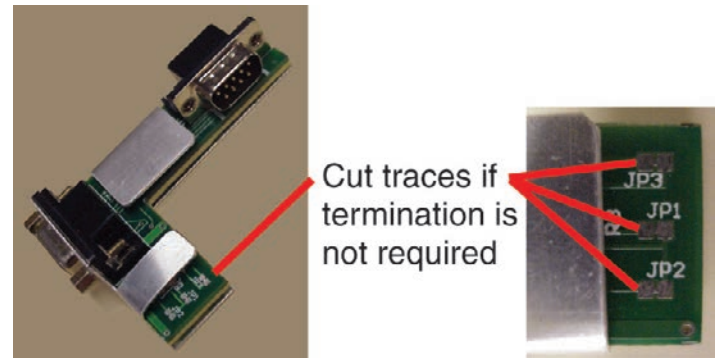

Figure A-3. Profibus Adapter PCB Assembly

A.5.2 Profibus Module Configuration

The Profibus interface is shipped from the factory with the address set to 3, the speed set to 19200 baud, and the memory length set to 122 words.

The memory length to can be reduced to 41 words if only alarms and fault are needed. Changing any of these parameters requires Procedure 1.

Table A-7. Procedure 1—Changing Profibus Configuration

F1.1.	Obtain a computer with free RS232 serial port.
F1.2.	Start a terminal emulator program such as HyperTerminal
F1.3.	Configure the terminal emulator for 38400,N,8,1
F1.4.	Connect the provided DB9 cable from the selected port on the computer to the top DB9 connector on the Profibus card.
F1.5.	Take the SLC 5/03 PLC CPU out of run mode by turning the key briefly to “PROG” then back to “REM”. Verify that the RUN light is off. The Profibus card will not enter terminal mode if the PLC is running.
F1.6.	Type asterisk (“ * “) up to 20 times until the following message is displayed: Profibus Module (DP, FDL)
F1.7.	Type “ locstn xx ” where xx is the desired Profibus address.
F1.8.	Type “ baud yyy ” where yyy is the desired baud rate from the set {9k6,19k2,93k75,187k5,500k,750k,1m5,3m,6m or 12m}.
F1.9.	Type “ shownet ” and verify that the communications parameters are as desired.
F1.10.	Type “ slvtxlen 0 0 zzz ” where zzz is the desired memory size in words, usually 41 or 122.
F1.11.	Type “ showslv ” and verify that the communication parameters are as desired
F1.12.	If additional information is desired type “ help ” and follow the instructions.
F1.13.	Type “ exit ” to save the changes
F1.14.	Put the SLC 5/03 PLC CPU into run mode by turning the key briefly to “RUN” then back to “REM”. Verify that the RUN light stays on.

A.6 DeviceNet Interface (P/N 1295-0329)

The DeviceNet network is a low-level network that provides connections between simple industrial devices and higher-level devices (such as PLC controllers and computers). DeviceNet network uses a combination of taps and shielded, twisted pair media for device connection.

For more information about DeviceNet, see www.odva.org.

Furthermore, the Allen Bradley DeviceNet Cable System Planning and Installation Manual is useful.

This can be downloaded from http://literature.rockwellautomation.com/idc/groups/literature/documents/um/dnet-um072_-en-p.pdf.

Technical Information on the Allen-Bradley 1747-SDN DeviceNet interface which is used in the Vertex M is available at http://literature.rockwellautomation.com/idc/groups/public/documents/webassets/browse_category.hcst.

The data map used by the DeviceNet interface is shown in [Table A-5](#). The interpretation of the data is in [Table A-3](#) and [Table A-4](#).

Successful commissioning of a DeviceNet Networks requires the use of a network management tool.

Such a tool can be constructed using a PC, an interface card and RSNetWorx or similar software. Use of special DeviceNet media is required. DeviceNet requires that each network segment include a power supply.

A.7 ControlNet Interface

ControlNet a real-time, control-layer network providing for high-speed transport of both time-critical I/O data and messaging data, including upload/download of programming and configuration data and peer-to-peer messaging, on a single physical media link. Deterministic and repeatable, ControlNet offers high-speed, media redundancy and intrinsically safe options.

For more information about ControlNet, see www.controlnet.org. Technical Information on the Allen-Bradley 1747-SCNR ControlNet interface which is used in the Vertex M is available at http://literature.rockwellautomation.com/idc/groups/public/documents/webassets/browse_category.hcst.

The data map used by the ControlNet interface is shown in [Table A-5](#). The interpretation of the data is in [Table A-3](#) and [Table A-4](#).

Successful commissioning of a ControlNet Networks requires the use of a network management tool. Such a tool can be constructed using a PC, an interface card and RSNetWorx or similar software.

A.8 DF1 Interface (P/N1295-0343)

This module emulates the DF1 slave functionality of an Allen-Bradley SLC 5/03 DF1 port. It responds to queries for data from the N14 integer file by sending alarm, fault, and concentration data.

The DF1 protocol is defined by the Allen-Bradley DF1 Protocol and Command Set Reference Manual which can be downloaded from http://literature.rockwellautomation.com/idc/groups/literature/documents/rm/1770-rm516_-en-p.pdf.

Technical information on the ProSoft Technology MVI46-DFCM interface which is used in the Vertex M can be found at <http://www.prosoft-technology.com>.

The baud rate and address of the DF1 interface are set using the configuration profile utility as described in See [Section 3.6 Configuration Utility](#). Supported speeds range from 1200 to 57,600 baud with a default of 19,200. The DF1 address can be set from 2 to 127.

The data map used by the DF1 interface is shown in [Table A-5](#). This appears as the N14 file. The interpretation of the data is in [Table A-3](#) and [Table A-4](#).



DF1 connection is made to middle RJ45 socket

Figure A-4. DF1 Connection to RJ45 Socket

The pinout of the DF1 port is as follows:

Table A-8. Pinout of DF1 Port

RJ45 Pin	DB-9 Pin	RS-232 mode pin function	RS-422 mode pin function	RS-485 mode pin function
1	1		TxD+	TxD/RxD+
2	2	RxD	RxD+	
3	3	TxD		
4	4			
5	5	GND	GND	GND
6	6		RxD-	
7	7	RTS		
8	8	CTS	TxD-	TxD/RxD-
	9			

A.9 Modbus Plus Interface (P/N 1295-0330)

For more information on Modbus Plus, see <http://eclipse.modicon.com>. Technical information on the ProSoft Technology MVI46-MBP interface which is used in the Vertex M can be found at <http://www.prosoft-technology.com>.

The address of the Modbus Plus interface are set using the configuration profile utility as described in See [Section 3.6 Configuration Utility](#). Valid address values are from 1 to 64.

The ProSoft website contains the MVI46s-MBP User Manual. Of particular interest in this manual are the general specifications on page 9 (in the pdf document) and the status LED interpretations on page 58 (in the pdf document).

Always wait for 20 seconds after energizing the PLC or changing the address before evaluating the LEDs.

The data map used by the Modbus Plus interface is shown in [Table A-5](#). The interpretation of the data is in [Table A-3](#) and [Table A-4](#).

A.10 LonWorks Interface (P/N 1295-0329)

The LonWorks protocol permits peer-to-peer communication without relying on a central controller. Routers permit expansion of networks to include thousands of nodes. For more information about LonWorks see <http://www.echelon.com> or www.engenuity.com.

The LonWorks interface is implemented using a FieldServer Technologies model FS-B2011 bridge and other components. This is a purple box mounted below the PLC in the rear of the Vertex M rack. The interface can be operated in either Polled Mode or Bind Mode. A service pin is provided for node identification. LED indicators are provided for Power, Run, System Error, and Configuration Error. Media type is FTT-10 twisted pair. Information on the FS-B2011 may be obtained from <http://www.fieldserver.com>.

The LonWorks external interface has 154 network variable outputs as listed in [Table A-8](#). The interpretation of the data is in [Table A-3](#) and [Table A-4](#).

Table A-9. LonWorks Network Variable Outputs

Function	Names	Type	Number
Alarms	nvoAlm_1_1_1 to nvoAlm_3_3_8	SNVT_lev_disc	72
Faults	nvoFlt_1_1 to nvoFlt_3_3	SNVT_lev_disc	9
Concentrations	nvoConc_1_1_1 to nvoConc_3_3_8	SNVT_count	72
Heartbeat	nvoHeartbeat	SNVT_count	1

A.11 Modbus/TCP (P/N1295-0520)

Modbus/TCP provides the highly reliable communications like the other fieldbusses over fast, economical Ethernet media. This interface uses ProSoft-Technology MV146-MNET hardware. In the Vertex M, this interface is always a TCP server, never a client. For more information see www.prosoft-technology.com and www.modbus.org.

The 122 words of status information listed in [Table A-5](#) are mapped as Modbus holding registers 40001 to 40122.

A.11.1 Configuring the IP Address

The following resources are needed to needed to set the IP address of the Vertex M.

1. An external personal computer with Microsoft Windows 2000 or later operating system and an unused serial port.
2. The debugging cable shown in [Figure A-5](#).
3. The file "WATTCP.CFG". This may be supplied on a floppy disk or may be loaded in "C:\hmi\FieldbusFiles"



Figure A-5. Debugging Cable



Figure A-6. Connector Locations

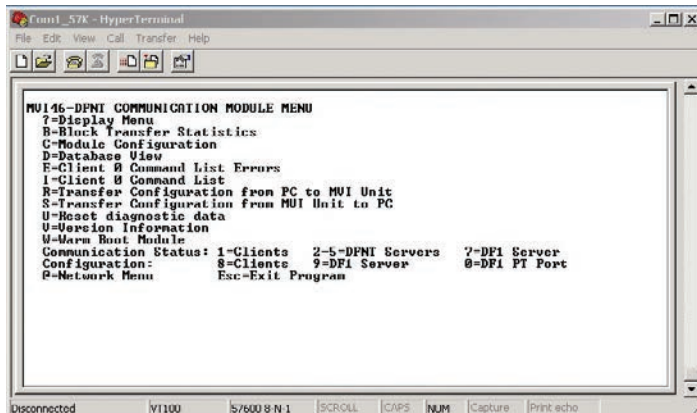

Figure A-7. HyperTerminal Setup for Diagnostic Port

```
# WATTCP.CFG file for ProSoft Technology MVI46.DFNT
# 05/25/2005 MJG -- modify for Zellweger Analytics, Inc.
my_ip=10.1.162.99
netmask=255.255.255.0
gateway=10.1.162.1
```

Figure A-8. WATTCP.CFG File

This procedure is used to set the IP Address

Procedure 1

1. Determine the desired IP address, subnet mask, and default gateway. Usually a network administrator will assign these numbers. Note that the MVI46-MNET will not function as a client for the DHCP protocol.
2. Modify the WATTCP.CFG file for the correct Internet parameters using a suitable editor such as Notepad. The default file is shown in Figure F-7.
3. Connect the debugging cable from the external PC to the “DEBUG” port on the MVI-46 as shown in Figure F-6.
4. Start HyperTerminal and configure for 57600 baud.
5. Type “?” in HyperTerminal.
6. Verify that the menu to appears as shown in Figure F-6.
7. Type “M@?”.
8. Verify that HyperTerminal displays:
 NETWORK MENU
 ?=Display Menu
 R=Receive WATTCP.CFG
 S=Send WATTCP.CFG
 V=View WATTCP.CFG
 M=Main Menu
9. Type “RY”
10. On the HyperTerminal menu bar, click on <Transfer>/<Send>.
11. Click on <Browse> and navigate to the location of “WATTCP.CFG” in the PC.

12. Click on <Open> and then <Send>.

Note:

An error will occur if the user takes more than 50 seconds to perform this step. If an error occurs, repeat this procedure.

13. Verify that HyperTerminal displays:

```
FILE TRANSFERRED FROM PC UNIT....THE
MODULE MUST RESTART...
```

14. Cycle power to the PLC.

15. The WATTCP.CFG file may be conveniently viewed with the “V” command.

A 10/100BaseT Ethernet network cable may now be connected to the top RJ45 jack.

Notes

1. Honeywell strongly recommends that any gas detection network which is connected to the Internet be protected from unauthorized access by a firewall.
2. Honeywell recommends that a gas detection Ethernet network be separated from a general-purpose computer networks by a switch. This is because the transmission time of Ethernet networks is non-deterministic and can become large if the network is heavily loaded.
3. When the interface is correctly installed in the PLC backplane the “BP ACT” light will glow steady amber. The “OK” light will glow steady green.
4. The “LINK” indicator will glow steady green when a valid physical-layer connection is established to an Ethernet switch.
5. An external computer can confirm that the interface is set to the correct IP address by use of the “ping” command.
6. The MVI46-MNET contains a second configuration file named “MNET.CFG”. If the

module was purchased from Honeywell, this file will be preloaded. Otherwise, the file provided in “C:\hmi\FieldbusFiles” must be loaded.

7. The 122 words of Vertex M status which are listed in Table F-5 may be viewed on the diagnostic port. These are mapped as registers 0 to 121 in the ProSoft database. Instructions on viewing the ProSoft database are in Chapter 6 of the ProSoft User Manual.
8. PC-based software for communicating with the MVI46-MNET and other Modbus/TCP devices may be purchased from Witte Software at www.modbustools.com.

A.12 Ethernet/CIP (P/N1295-0519)

EtherNet/CIP provides the highly reliable communications like the other fieldbusses over fast, economical Ethernet media. This interface uses ProSoft-Technology MVI46-DFNT hardware. In the Vertex M this interface is always a server, never a client. For more information see www.prosoft-technology.com and www.controlnet.org.

This interface provides 122 words of status information as listed in [Table A-9](#). The presentation of this data varies depending on the type of client used. Examples of this presentation are included at the top of page 18 in the ProSoft User Manual and also in [Table A-9](#).



WARNING

It is essential that Ethernet/CIP clients which communicate with the Vertex M monitor the “Heartbeat” byte in word 40. This is because the MVI46-DFNT will continue to communicate if the Vertex M PLC ceases to run. External automation equipment must be programmed to treat a failure of the heartbeat to increment as a complete loss of gas detection.

Table A-10. Data Presentation in Various PLCs

Database Address	Vertex M Meaning	PLC2 Address	PLC5 or SLC Address	ControlLogix		
				PCC	CIP Byte	CIP Integer
0 to 35	point alarm status	0 to 35	N10:0 to N10:35	N10:0 to N10:35	SintData[0] to SintData[71]	Int_Data[0] to Int_Data[35]
36 to 40	analyzer fault status	36 to 40	N10:36 to N10:40	N10:36 to N10:40	SintData[72] to SintData[80]	Int_Data[36] to Int_Data[40]
	heartbeat				SintData[81]	
41 to 49	undefined	41 to 49	N10:41 to N10:49	N10:41 to N10:49	SintData[82] to SintData[99]	Int_Data[41] to Int_Data[49]
50 to 121	point gas concentration	50 to 121	N10:50 to N10:121	N10:50 to N10:121	SintData[100] to SintData[243]	Int_Data[50] to Int_Data[121]
122 to 3999	undefined	122 to 3999	N10:122 to N13:999	N10:122 to N13:999	SintData[244] to SintData[7999]	Int_Data[122] to Int_Data[3999]

A.12.1 Configuring the IP Address

The IP address of this interface is set using a procedure similar to that listed in [Section F.11](#). The file “WATTCP.CFG” is modified with Notepad and downloaded with HyperTerminal.

Notes

1. Honeywell strongly recommends that any gas detection network which is connected to the Internet be protected from unauthorized access by a firewall.
2. Honeywell recommends that a gas detection Ethernet network be separated from a general-purpose computer networks by a switch. This is because the transmission time of Ethernet networks is non-deterministic and can become large if the network is heavily loaded.
3. When the interface is correctly installed in the PLC backplane the “BP ACT” light will glow steady amber. The “OK” light will glow steady green.
4. The “LINK” indicator will glow steady green when a valid physical-layer connection is established to an Ethernet switch.
5. An external computer can confirm that the interface is set to the correct IP address by use of the “ping” command.
6. The MVI46-DFNT contains a second configuration file named “DFNT.CFG”. If the module was purchased from Honeywell, this file will be preloaded. Otherwise, the file provided in “C:\hmi\FieldbusFiles” must be loaded.
7. The 122 words of Vertex M status which are listed in [Table F-5](#) may be viewed on the diagnostic port. These are mapped as registers 0 to 121 in the ProSoft database. Instructions on viewing the ProSoft database are in chapter 6 of the ProSoft User Manual.

8. If desired, Allen-Bradley RSLinx software may be used to communicate with the MVI46-DFNT. This is explained in Appendix E of the ProSoft User Manual.

A.13 Vertex M Remote Display Setup

A.13.1 Checking Remote Session Count

The Vertex M Diagnostics option lets you verify the number of remote Niagara licenses.

In the main display screen, touch the **Menu** button, then touch **Diagnostics**. This displays the **System Information** window. The number of licenses is displayed to the right of “Remote Sessions Count”.

Note: If there are not sufficient licenses or if all licenses are in use, you will not be able to access the Vertex M remotely. Changing this number is beyond the scope of this procedure; contact your Honeywell Analytics representative for more information.

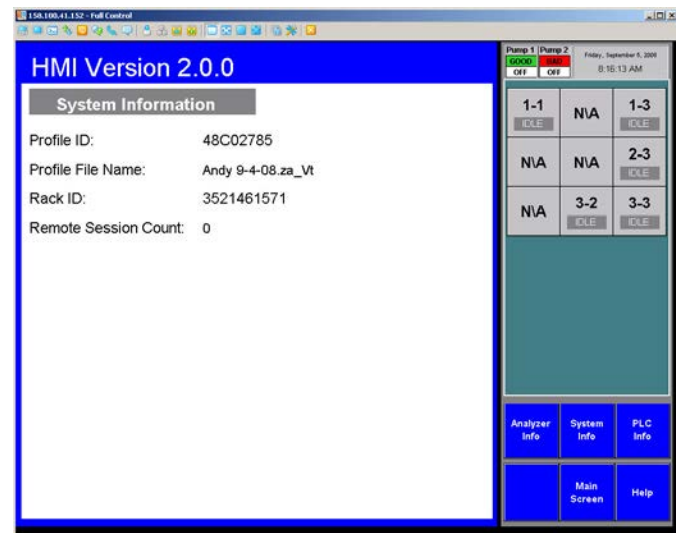

Figure A-9. Checking Remote Session Count

A.13.2 Determining the IP Address

Many computer networks contain a DHCP server

that sets the IP (internet protocol) address of the rack automatically. This number is necessary to establish communication with the rack. The address is available by running a command prompt, the “ipconfig” command as shown in Figure 2. Note that the Vertex M has two Ethernet interfaces: the address of “**External_Ethernet**” is the relevant one, as shown in the image below.

```
Microsoft Windows XP [Version 5.1.2600]
(C) Copyright 1985-2001 Microsoft Corp.

C:\Documents and Settings\Honeywell Analytics>ipconfig

Windows IP Configuration

Ethernet adapter External_Ethernet:

    Connection-specific DNS Suffix  . : GLOBAL.DC.HONEYWELL.COM
    IP Address . . . . . : 158.100.41.152
    Subnet Mask . . . . . : 255.255.254.0
    Default Gateway . . . . . : 158.100.40.1

Ethernet adapter Internal_Ethernet:

    Connection-specific DNS Suffix  . :
    IP Address . . . . . : 192.168.254.1
    Subnet Mask . . . . . : 255.255.255.0
    Default Gateway . . . . . :

C:\Documents and Settings\Honeywell Analytics>
```

Figure A-10. ipconfig Command

A.13.3 Basic Desktop Station Setup

This adapts a desktop computer for viewing the Niagara HMI. In this basic configuration, event history and data trend are available. But the following features are unavailable remotely:

- Chemcam viewer
- Configuration editor
- Event database export
- Concentration trend database export

A.13.3.1 Installing Java Runtime Environment Software

The Java runtime environment must be installed on the desktop to view Niagara Racks. If this is not installed on your PC, you must install it to use the virtual Vertex M: Click on the **Free Java Download** button on the webpage (<http://www.java.com>) and follow the prompts.

A.13.3.2 Install Adobe Reader Software

Adobe Acrobat Reader is needed to view this Technical Handbook on the remote station. This may be downloaded from www.adobe.com. Click on <Get Adobe Reader> and follow the prompts.

A.13.3.3 Create HMI account

Creating multiple HMI accounts is useful to facilitate using the HMI security system to control access to the HMI’s features. This is described in [Section 4.6.6](#) of the Vertex M Technical handbook. The default account has the username “administrator” with the password “administrator”.

A.13.3.4 Starting the Niagara Remote Display

The Niagara remote display is presented in Microsoft Internet Explorer, versions IE6 and IE7.

Type the Vertex M rack’s IP address in the IE Address bar to start the virtual Vertex M display. The address must begin with <http://> and must end with “:88” In the example, the URL <http://158.100.40.130:88> displays the virtual Vertex M, shown in the following page. The initial startup may take a few moments before the login window appears.

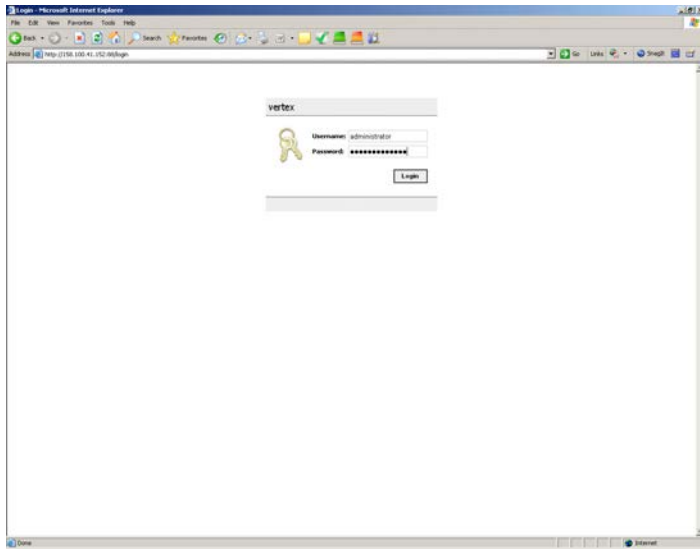

Figure A-11. Starting Niagara Remote Display



TIP

Adding the Vertex M IP address to the IE Favorites folder saves time.

The Vertex M HMI will appear in Internet Explorer as shown in [Figure F-12](#). The virtual Vertex M interface can be displayed on most screen sizes (1024 X 768 is a minimum, however larger screens are better for this application).

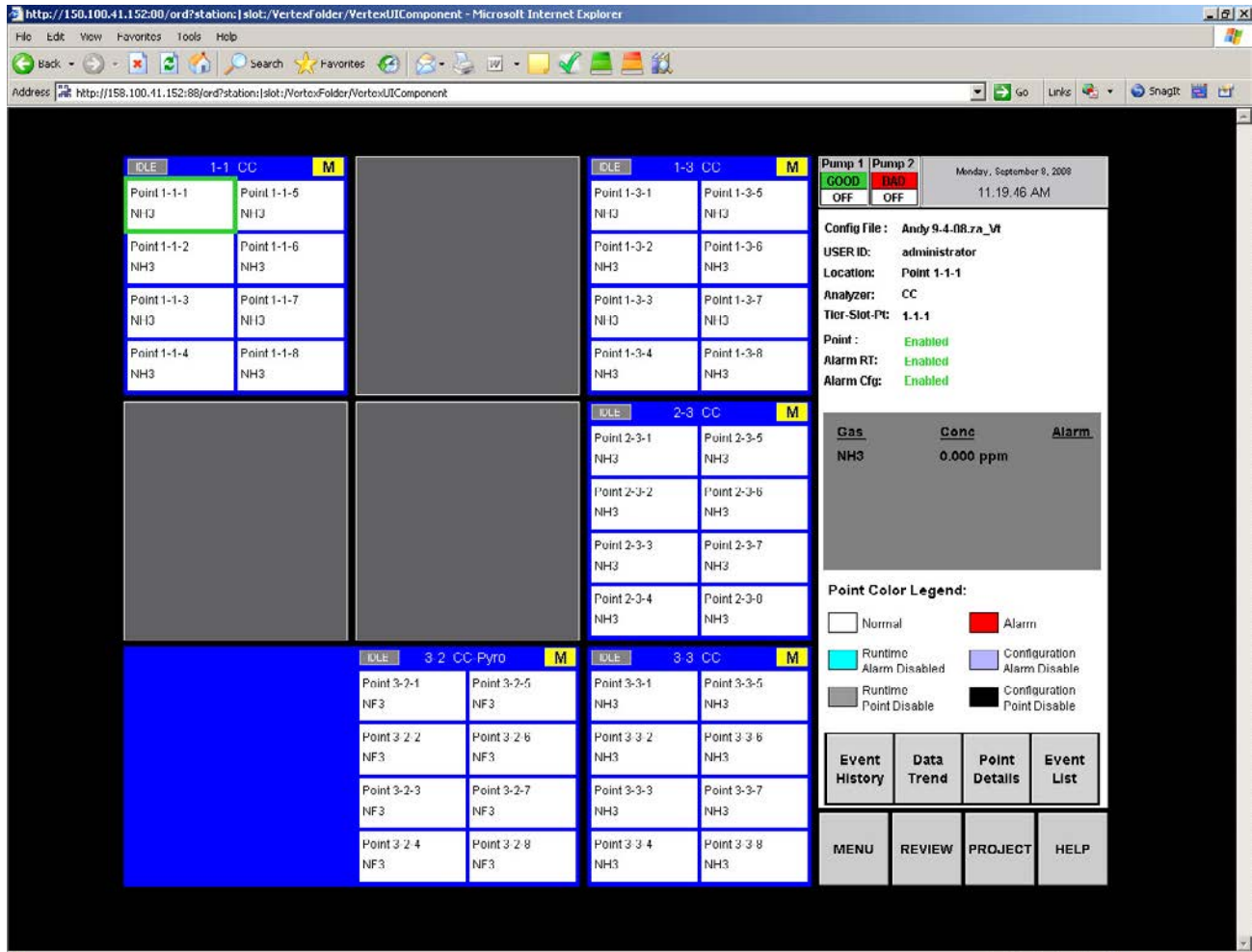

Figure A-12. Vertex M HMI in Internet Explorer

A.13.4 Full Desktop Station Setup

This adapts a desktop computer for complete HMI functionality including the Chemcam Viewer. However, the Configuration Editor and Chemcassette installation screens are not available remotely.

Vertex M Client is distributed on the Vertex M Application Software CD.

Remote configuration is possible but requires changing many security settings. Contact Honeywell Analytics for information on permitting remote configuration.



WARNING

The procedures provided in this section require making changes to your computer's security and component settings. Only qualified personnel should undertake this procedure.

A.13.4.1 Add Honeywell software to Desktop

The "VertexClient" software from Honeywell Analytics must be installed in the desktop computer for correct operation. Previous versions of VertexClient must be removed before installing the newer version (Start/Control Panel/Add or Remove Programs).



CAUTION

Protect both the remote station and the network between it and the Vertex monitor from unauthorized contact. Software changes increase the vulnerability of the Vertex rack to malicious attack.

A.13.4.2 Create a "Honeywell Analytics" account

This is described in [Section A.13.4.7 Create matching Windows Accounts](#).

A.13.4.3 Create Group "VertexDCOMUsers"

This group is needed to facilitate acceptance of the credentials of the two computers. To do this

1. Click on <Start>.
2. Then click-right on <My Computer>. Select "Manage".
3. Navigate to Computer Management / System Tools / Local Users and Groups / Groups.
4. Create a group "VertexDCOMUsers"
5. Add members "Everyone", "Interactive", "Network" and "System" as shown in [Figure A-13](#).

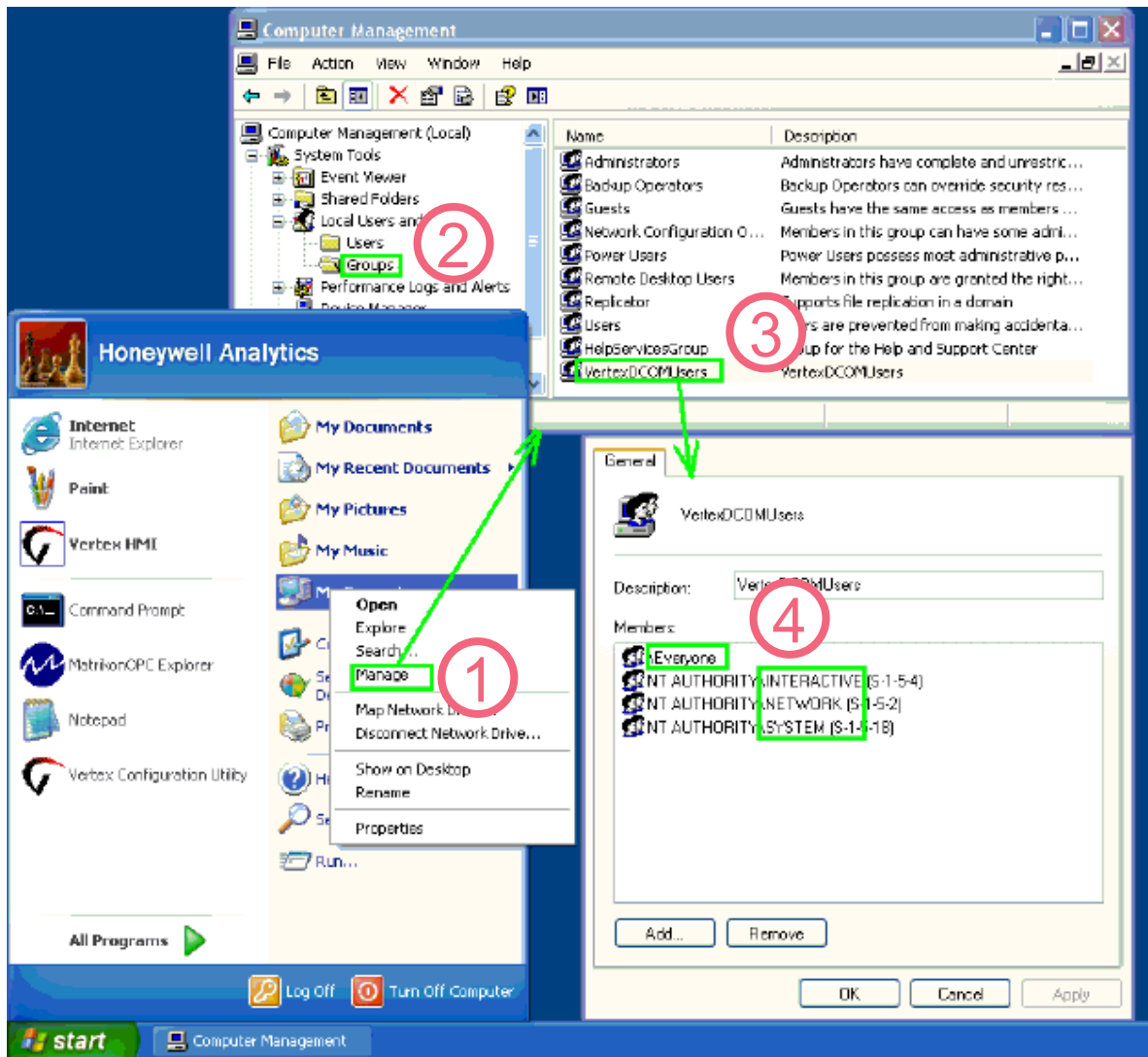

Figure A-13. Create Group “VertexDCOMUsers”

A.13.4.4 Disable Windows Firewall

This is described in [Section A.13.4.6 Windows Firewall](#).

A.13.4.5 Configure DCOM

Remote operation of the Chemcam Viewer and the Configuration Editor requires numerous changes to Windows XP using the **dcomcnfg** program:

- Click on Start and then Run...
- In the Run window, type **dcomcnfg** and click OK. The **Component Services** window opens

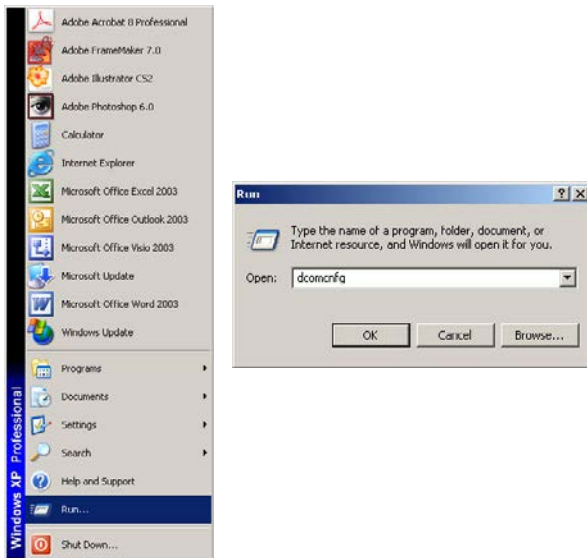

Figure A-14. Starting Component Services

Note:

If a DCOM Configuration Warning! window appears, simply click on Yes to record the warning and continue with the procedure.

The **Component Services** tool allows users to set default security for the entire computer and security settings for individual programs. Some programs require special attention. See [Table F-11](#) for complete details.

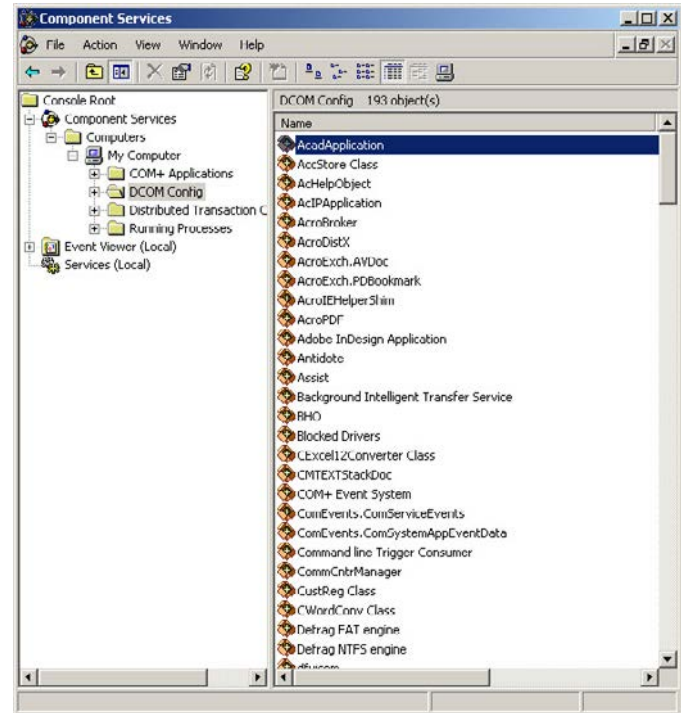

Figure A-15. Component Services

First, modify the security settings for the computer:

- Click on Component Services to display sub-options, until my computer is visible.
- Right-click My Computer and select Properties. This opens the My Computer Properties window.
- Click on the COM Security tab, which contains both Access Permissions and Launch and Activation Permissions.

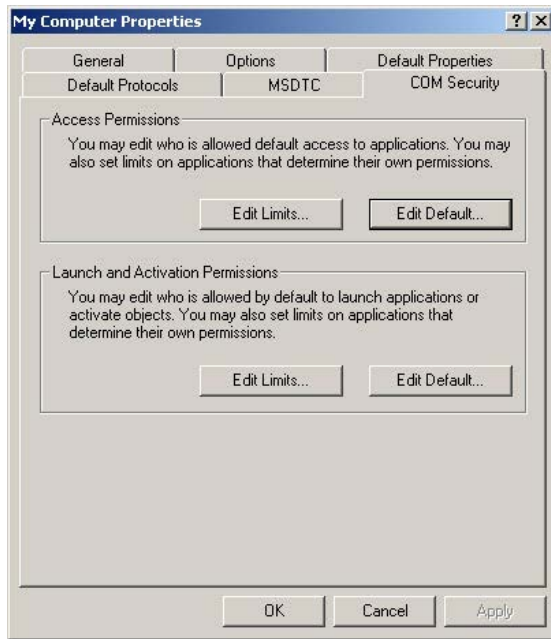

Figure A-16. COM Security Tab

- Click on any Edit button to open a Permission window. Check to Allow or uncheck to Deny permissions.

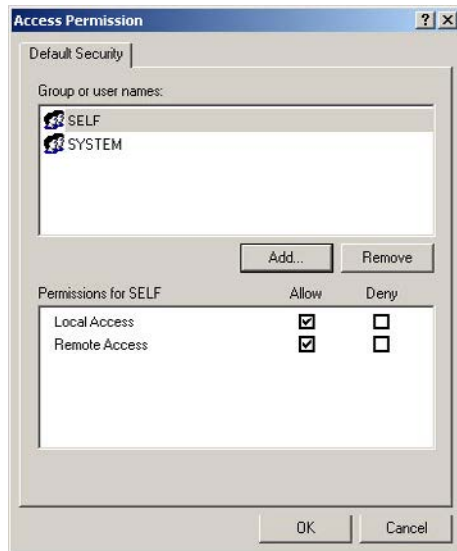

Figure A-17. Access Permission

[Table A-12](#) contains the programs that need security modifications and which modifications are required. [Table A-11](#) contains the explanations for the abbreviations used in [Table A-12](#).

Table A-11. Category Symbols

Symbol	Label
APED	Access Permissions / < Edit Default > button
APEL	Access Permissions / < Edit Limits > button
LAED	Launch and Activation Permission/ < Edit Default > button
LAEL	Launch and Activation Permission/ < Edit Limits > button

1. Most changes are under “Console Root / Component Services / Computers / My Computer”. This is abbreviated to “CR/CS/C/ MC” in Table 2.
2. The necessary DCOM permission settings are listed below. In many cases it is necessary to add new objects. (a.k.a. Group or user names”)
3. In some cases, Windows XP requires that “custom” permissions be used instead of the equivalent default permissions.:
4. Select the program in the Component Services window and right-click to select Properties.
5. Click to select “**Customize**” then click **Edit** as shown on the following page.

	<p>Permissions for a particular program can revert from custom to default if they match the default permissions. The recommended workaround is to create a new object “Guest”. (singular, not “Guests” plural). This prevents XP from reverting to default.</p>
--	---

6. Click “Apply” after making changes as shown in [Figure A-17](#).
7. Reboot remote computer after configuration.

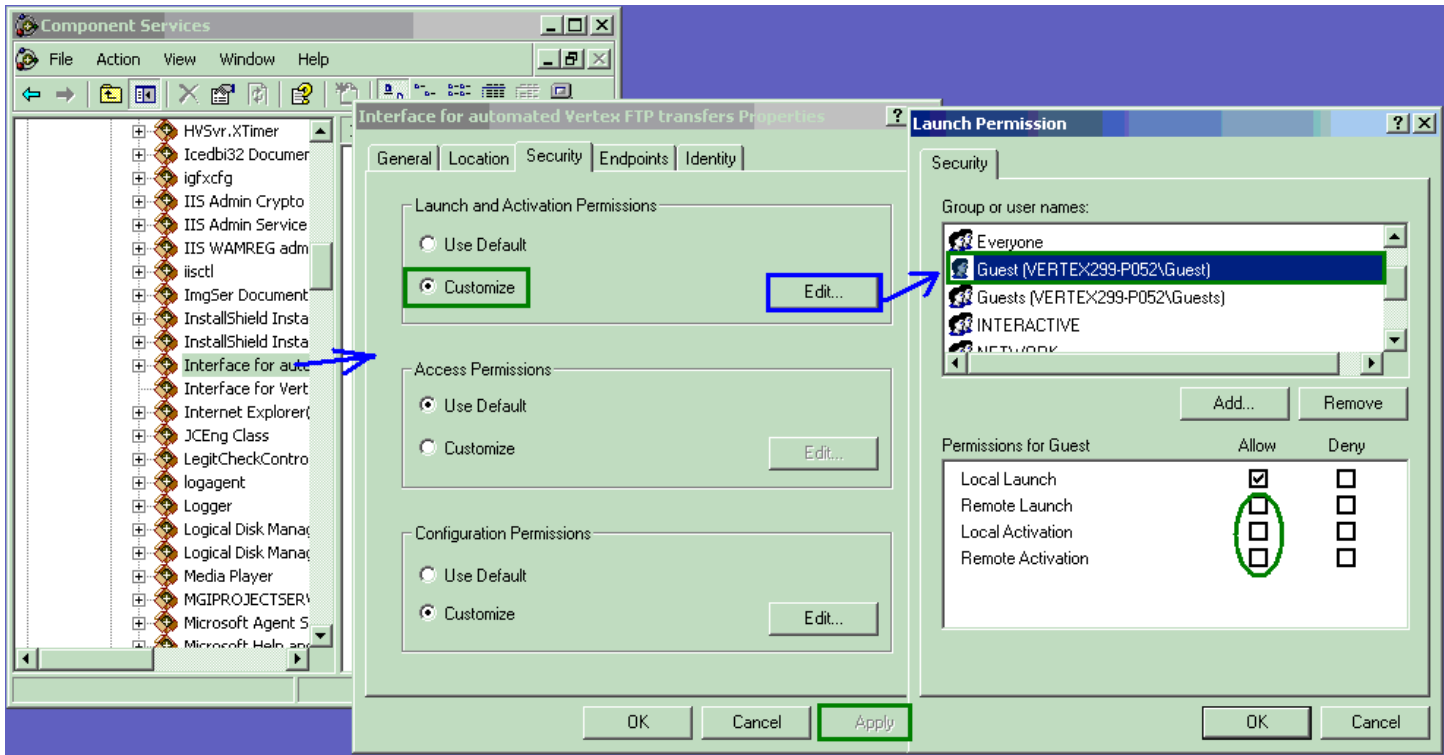

Figure A-18. Custom Permissions

Table A-12. Program List for Security Modifications

Program	Tab	Category (See Table F-11)	Object	Value
CR/CS/C/MC/ Properties	COM Security	APED	Administrators, ANONYMOUS LOGON, Everyone, Guests, INTERACTIVE, NETWORK, SYSTEM, Users, VertexDCOMUsers	all "Allow"
		APEL	ANONYMOUS LOGON, Everyone, Interactive, Network, System	all "Allow"
		LAED	Administrators, ANONYMOUS LOGON, Everyone, Guests, NETWORK, Users VertexDCOMUsers	all "Allow"
			INTERACTIVE, SYSTEM	"Local Launch" and "Local Activation"
		LAEL	Administrators, ANONYMOUS LOGON, Everyone, INTERACTIVE, NETWORK, SYSTEM,	all "Allow"
	Default Properties		"Default Authentication Level"	"None"
			"Default Impersonation Level"	"Identify"

Table 12. Program List for Security Modifications (continued)

CR/CS/C/MC/DCOM Config/ChemCamSrv. Chemcam AND OPCEnum	Identify		Which user account do you want to use to run this application?	"The interactive user" (Note this setting not needed for OPCEnum.)	
	General		Authentication level	"None"	
	Security	Launch and Activation Permissions/ Customize/<Edit>	Guest		all "Allow"
			All pre-existing objects		all "Allow"
		Access Permissions/ Customize/<Edit>	Guest		all "Allow"
			All pre-existing objects		all "Allow"

A.13.4.6 Windows Firewall

The Windows Firewall must be turned off:

- Click on **Start** in the Windows taskbar
- Select **Settings** and then **Control Panel** from the menu.

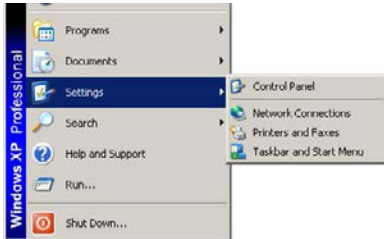

Figure A-19. Control Panel

- Double click on Windows Firewall and click to select **Off (not recommended)**, as shown in Figure F-19.

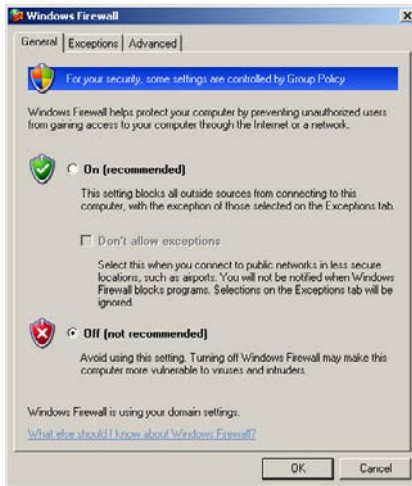

Figure A-20. Windows Firewall

A.13.4.7 Create matching Windows Accounts

Microsoft Windows security requires that matching accounts exist on both the rack and the desktop to provide the necessary credentials. Every Vertex M rack ships with an account named “Honeywell Analytics” and the password “vertex” One way to provide the matching accounts is to create a similar account on the desktop.

- Click on **Start** in the Windows taskbar and select **My Computer**
- Right-click on **Properties** to open the Computer Management screen.
- Add a new account as shown in Figure F-20. Also add “Honeywell Analytics” to the “Administrators” group.

Note:

If My Computer does not appear in the Start menu, it may be necessary to search for Computer Management.

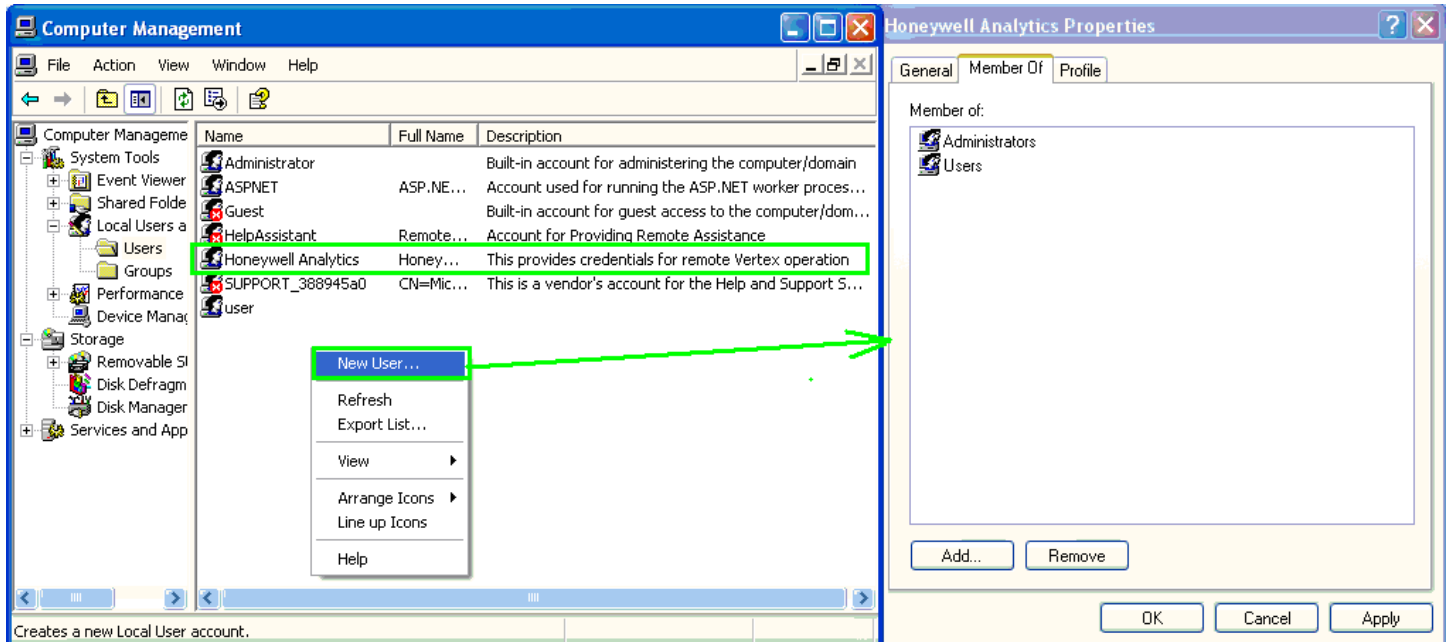

Figure A-21. Computer Management

A.14 Demonstrating Remote OPC Communication

This procedure describes how to set up OPC communications from a Vertex M rack and an external Microsoft Windows computer. Some of the required files are provided on the Vertex M CD.

A.14.1 Setup Procedure

1. Create “Honeywell Analytics” account as listed in [Section A.13.4.7 Create matching Windows Accounts](#) if account does not exist.
2. Log into “Honeywell Analytics” account.
3. Disable the Windows firewall, as described in [Section A.13.4.6 Windows Firewall](#).
4. Install the OPC core components provided on the Vertex M CD (or download from <http://www.opcfoundation.org/SiteMap.aspx?MID=Downloads>, after registration. It is also on the Vertex M Application CD.
5. Confirm that both computers have valid names with the DNS server.
6. The external computer registry must be modified to make it ‘aware’ of the OPC server. This can be conveniently accomplished by running the file Vertex_OPC_Server_Info_RN.REG which is on the Vertex M CD.
7. Determine the IP address of the rack. This can be done with the “ipconfig” command See [Section F.13.2 Determining the IP Address](#) in a command prompt window on the Vertex M.
8. Confirm that IP communication to the rack works This can be done by using the “ping” command in a command prompt.
9. Create an account on the external computer “Honeywell Analytics” with the password of “vertex”. See [Section F.13.4.4 Create matching Windows Accounts](#). To do this, select Start/MyComputer/Manage/LocalUsersAndGroup/Users. Also add the user to the “Administrators” group. Log in using this account.
10. Install an OPC Client program on the external computer. Screenshots of two examples are included. The Matrikon OPC Explorer is on the Vertex M CD and is pre-installed on the Vertex M rack. It may also be downloaded from www.matrikon.com. Additionally, DAClient from Rockwell Software might be useful and is shown here. Contact Rockwell Software to obtain this.
11. Edit the DCOM configuration as listed in [Table F-12](#). It is necessary to click on the [Apply] button before closing the properties form for each object. For information on this, see [Section F.13.4.2 Configure DCOM](#). This is noted in boldface.
12. Reboot the external computer.

A.14.2 Demonstration with Matrikon OPC Explorer

1. Install the program.
2. Start OPC Explorer.
3. Set “View”/“Options”/“General”/“Browse Methods” = “Registry”. Start the program.
4. Select <Server>/<Add/Connect Server>
5. Fill in the IP address or host name.
6. To communicate with a Niagara rack, fill in the server name with “Honeywell.VertexOPCServerDA.1” as shown below. To communicate with an RSView rack, use a server name of “RSI.32OPCTagServer”.

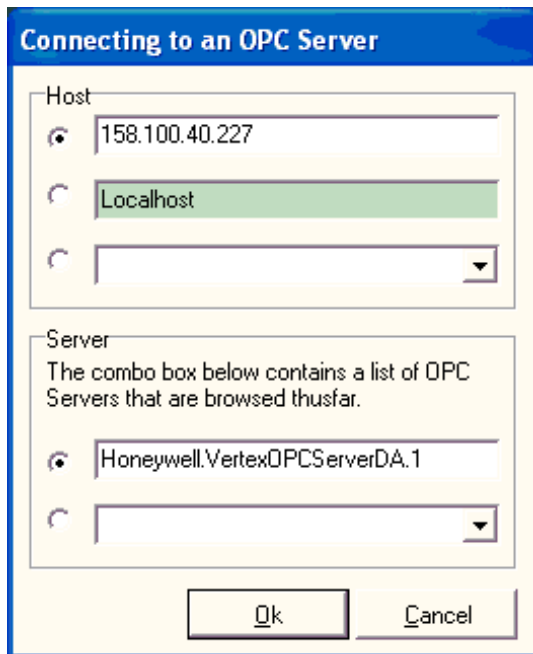

Figure A-22. Connecting To An OPC Server

7. Expand the tree on the left to reveal the Vertex M server as highlighted in purple the Matrikon OPC Explorer window in Figure F-23.

8. Click on **Server** then select **Add Group**. The example name is “g1”.
9. Select the group as shown highlighted in [Figure F-22](#).
10. Click on **Group** then select **Add Items**. The group’s Matrikon Explorer window opens.
11. In the group’s explorer window, make sure that the “Write Access” checkbox is unchecked.
12. Select an item from the list of Available Items (as shown underlined in pink in the MatrikonOPC Explorer (g1) window).
13. Double click on a tag as shown underlined in green in the MatrikonOPC Explorer (g1) window.
14. Confirm that the desired tag name appears in the “Item ID” textbox.
15. Click the large arrow (Add) button as highlighted in yellow in the MatrikonOPC Explorer (g1) window.
16. Repeat above steps as desired. It is also possible to add tags by right-clicking on the tag and selecting “Add all items to tag list”.
17. Click on **File** then select **Close**
18. Verify that the tag quality is “Good” as shown in light-blue in the Matrikon OPC Explorer window in [Figure F-22](#).

Matrikon OPC Explorer window

The screenshot shows the Matrikon OPC Explorer interface. The left pane displays a tree view of network resources, with 'Honeywell.VertexOPCServerDA.1' and 'MyGroup1' highlighted. The main pane shows a table of OPC items under 'MyGroup1'. The table has columns for Item ID, Access, Value, Quality, Timestamp, and Status. The items listed are 'FlowControl\Flow\1' through 'FlowControl\Flow\19' and 'FlowControl\Flow\2'. The status for all items is 'Active'. Below the table, there are sections for 'Server Info' and 'Group Info'. The server info shows 'Server: Honeywell.VertexOPCServerDA.1', 'Connected: Yes, on 158.100.40.227', and 'State: Running'. The group info shows 'Group: MyGroup1', 'Connected (Async I/O): Yes (2.0)', and 'Active: Yes'. A banner for 'EXECUTIVE OPC power to shape industry' is also visible.

Item ID	Access ...	Value	Quality	Timestamp	Status
FlowControl\Flow\1		0	Good, non-spe...	4/27/2009 7:5...	Active
FlowControl\Flow\10		180	Good, non-spe...	4/27/2009 7:5...	Active
FlowControl\Flow\11		186	Good, non-spe...	4/27/2009 7:5...	Active
FlowControl\Flow\12		183	Good, non-spe...	4/27/2009 7:5...	Active
FlowControl\Flow\13		177	Good, non-spe...	4/27/2009 7:5...	Active
FlowControl\Flow\14		187	Good, non-spe...	4/27/2009 7:5...	Active
FlowControl\Flow\15		177	Good, non-spe...	4/27/2009 7:5...	Active
FlowControl\Flow\16		183	Good, non-spe...	4/27/2009 7:5...	Active
FlowControl\Flow\17		0	Good, non-spe...	4/27/2009 7:4...	Active
FlowControl\Flow\18		0	Good, non-spe...	4/27/2009 7:4...	Active
FlowControl\Flow\19		0	Good, non-spe...	4/27/2009 7:4...	Active
FlowControl\Flow\2		0	Good, non-spe...	4/27/2009 7:4...	Active

Figure A-23. Matrikon OPC Explorer Window

MatrikonOPC Explorer (g1) window

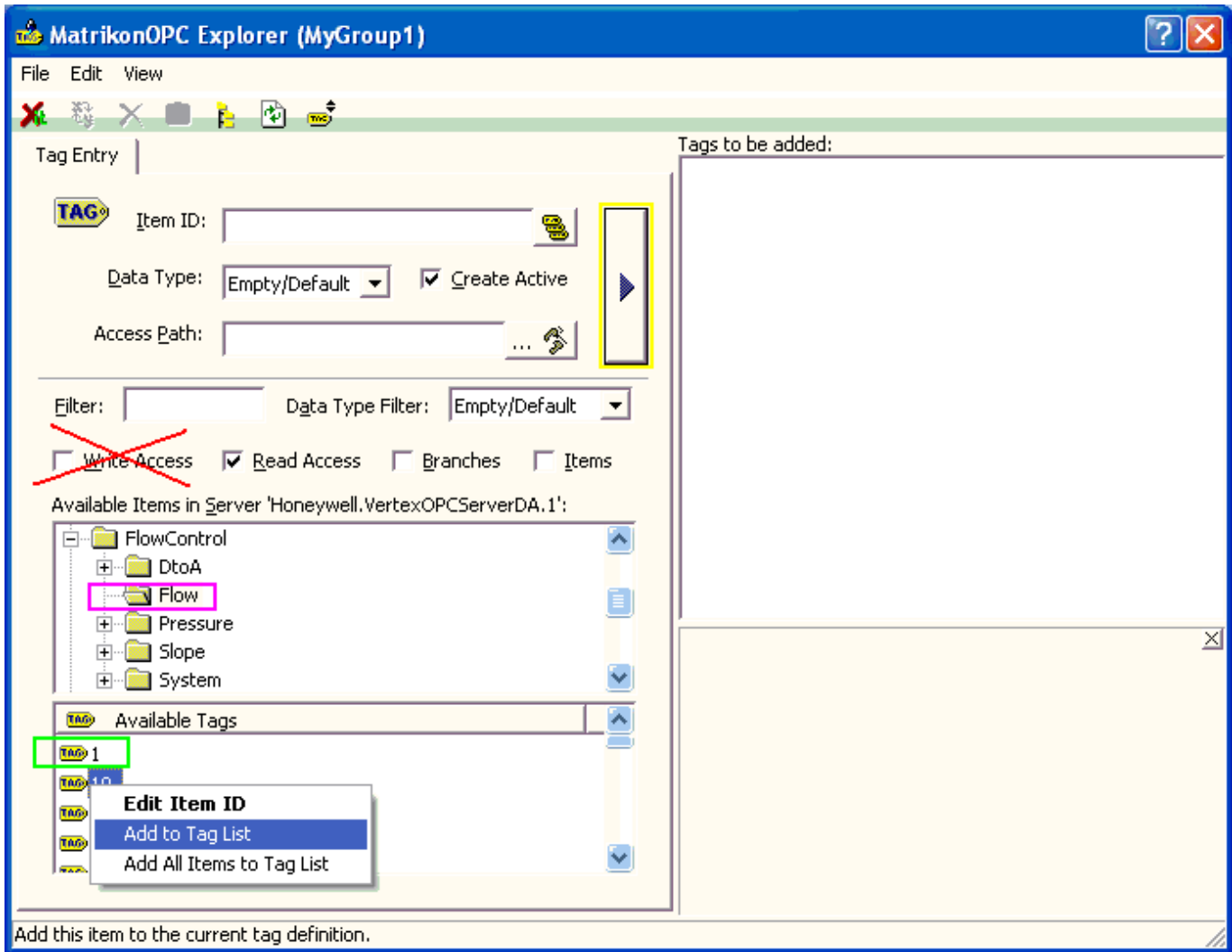

Figure A-24. MatrikonOPC Explorer (g1)

A.14.3 Demonstration with DAClient

Note:

DAClient is a free OPC demonstration program from Rockwell Software.

1. Start the program. Type in the name of the OPC Server and the OPC server machine as shown in Figure F-24.

2. Select a group name such as the default “Group1”.
3. Select tags by double-clicking on the bottom-right box of the “Add Item” form as shown in Figure F-25.

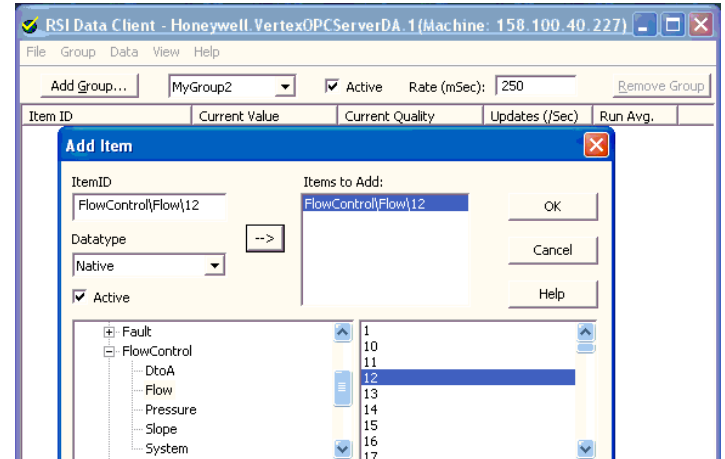
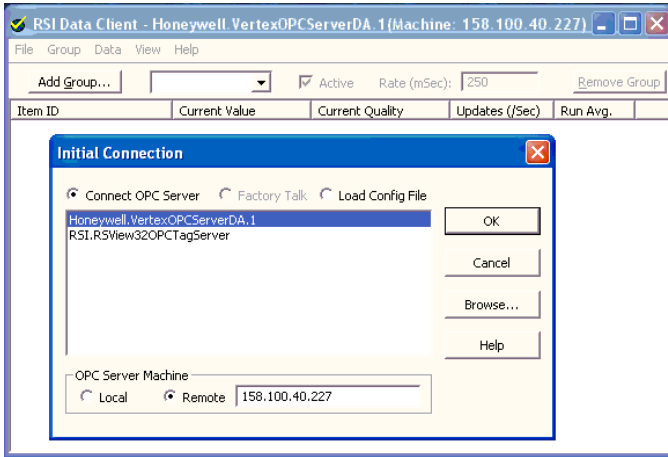

Figure A-26. Add Item Form

Figure A-25. Enter OPC Server and Machine Name

- When all desired tags have been added, click **OK** to close the window
- Verify that data appears with Current Quality set to “Good” as shown.

The screenshot shows the 'RSI Data Client' window for 'Honeywell.VertexOPCServerDA.1 (Machine: 158.100.40.227)'. The window has a menu bar with 'File', 'Group', 'Data', 'View', and 'Help'. Below the menu bar, there are controls for 'Add Group...', a dropdown menu showing 'MyGroup2', a checked 'Active' checkbox, a 'Rate (mSec):' field set to '250', and a 'Remove Group' button. The main area contains a table with the following data:

Item ID	Current Value	Current Quality	Updates (/Sec)	Run Avg.
FlowControl\Flow\12	174	Good	31 (1)	0.576
FlowControl\Flow\11	181	Good	8 (0)	0.815
FlowControl\Flow\12	174	Good	5 (1)	0.510
FlowControl\Flow\13	177	Good	5 (0)	0.510
FlowControl\Flow\14	200	Good	9 (1)	0.917
FlowControl\Flow\15	182	Good	11 (1)	1.121
FlowControl\Flow\16	186	Good	9 (0)	0.917
FlowControl\Flow\17	0	Good	1 (0)	0.102
FlowControl\Flow\18	0	Good	1 (0)	0.102

Figure A-27. RSI Data Client

**A 4-20mA Analog
Output Option**

A.1 Overview

The application provides an analog output option for the Vertex M by utilizing a second SLC 5/03 PLC rack. This rack communicates with the primary PLC via the DF1 Fieldbus option.

A.2 Hardware Requirements

Primary PLC	The primary Vertex M PLC must be configured with the DF1 Fieldbus option. This option includes the following hardware:	
	(1)	Prosoft MVI46-DFCM module installed in slot 2
Secondary PLC	The secondary PLC requires the following items	
	(1)	Prosoft RJ45 to DB9 adaptor cable
	(1)	1746-A7 Rack
	(1)	1746-P4 Power supply
	(1)	1747-L532 SLC 5/03 Processor
	(1)	RS232 Null Modem Cable
	(6)	Spectrum Controls 1746sc-INO4i Analog Output Modules
Any required mounting hardware to mount PLC rack in Vertex M Chassis		

A.3 Configuration Requirements

Primary PLC – In addition to loading the correct program for the DF1 Slave, the primary PLC must also have the channel number and baud rate for the PLC setup properly. The procedure for configuring these parameters is documented in [Section 3.6 Configuration Utility](#). The ‘Fieldbus’ radio button must be selected for DF1, the ‘Set Address’ field needs to be set to 10 and the ‘Set Baud Rate’ field set to 19,200.

The Prosoft DF1 module in the primary PLC also has one required jumper setting. The com2 jumper must be in the RS232 position. This is the default configuration.

Secondary PLC – The secondary PLC must be assembled with the 5/03 module in the first slot (slot 0) and all other slots populated with Spectrum Controls 1746sc-INO4i modules. No configuration is needed on these modules, however there is a user settable dip switch for selecting between rack loop power and external loop power. This is an application specific setting, the default is rack power.

The RS232 port on the secondary PLC’s 5/03 module (bottom port on module) must be connected to the Prosoft module’s port 2 (middle port on module in slot 2 of primary PLC rack).

The only software configuration needed is to load the PLC program (“VertexM AnalogOut Rack2.rss”) into the Secondary PLC 5/03 processor. The software required to load this is RSLogix 500 and RSLinx.

Once the PLC program has been loaded, the standard RS232 port will be configured for communication with the Prosoft DF1 module and will not support the standard COM port connection for programming. Any subsequent attempts to load the PLC (either to restore factory default or load program revisions) will require following a procedure to clear the PLC memory or communication through the DH485 port. Connecting to this port requires a special adaptor (1747-UIC) and cable (1747-C13). Contact Honeywell Analytics Service for assistance.

A.4 Operational Description

The analog outputs on the secondary PLC will mirror the corresponding Fieldbus concentration register as defined in [Section F.3.2 Concentrations](#). This section fully describes the outputs under normal operating conditions. The following table describes the outputs including some additional error states.

Condition	Channel Output	Notes
Normal	Concentration Value or 2 mA fault indicator	See Section F.3.2 . 2ma fault indicator must be enabled and is off by default
Primary PLC Failure	1 mA on all channels	Including PLC faulted or in program mode
Com Failure	1 mA on all channels	Communication link failure between Primary and Secondary PLC's
Secondary PLC Failure	0 mA on all channels	Including PLC faulted or in program mode

Channel mapping is defined by the following Table G-1.

Table A-1.

Vertex M Point	Secondary PLC Slot	AO Channel on Card
1-1-1	Slot 1	Ch. 0
1-1-2	Slot 1	Ch. 1
1-1-3	Slot 1	Ch. 2
1-1-4	Slot 1	Ch. 3
1-1-5	Slot 2	Ch. 0
1-1-6	Slot 2	Ch. 1
1-1-7	Slot 2	Ch. 2
1-1-8	Slot 2	Ch. 3
1-2-1	Slot 3	Ch. 0
1-2-2	Slot 3	Ch. 1
1-2-3	Slot 3	Ch. 2
1-2-4	Slot 3	Ch. 3
1-2-5	Slot 4	Ch. 0
1-2-6	Slot 4	Ch. 1
1-2-7	Slot 4	Ch. 2
1-2-8	Slot 4	Ch. 3
1-3-1	Slot 5	Ch. 0
1-3-2	Slot 5	Ch. 1
1-3-3	Slot 5	Ch. 2
1-3-4	Slot 5	Ch. 3
1-3-5	Slot 6	Ch. 0
1-3-6	Slot 6	Ch. 1
1-3-7	Slot 6	Ch. 2
1-3-8	Slot 6	Ch. 3

**A Line Integrity Test
Option**

Honeywell Analytics now offers the optional capability to check for leaks in Vertex M sample lines. Analyzers equipped with option 1295-0510 detect a pneumatic signal from valves installed at the end of the sample line. Any leak in the tubing will cause a change in the signal and will be detected. This test is performed automatically as a line integrity test (LIT). This new test complements the ability of all Vertex M analyzers to detect blocked sample lines.

The Line Integrity Test Option requires a minimum software revision of 1.21.1 and configuration of analyzer software by a Honeywell Analytics Field Service Engineer.

Pneumatic Overview

The pneumatic design of the Vertex M rack is summarized in [Figure H-1](#). The Vertex M analyzer contains eight sample pressure transducers, one for each point. The external tubing is terminated with a filter and a check valve. The check valve will not permit any flow until a “cracking” pressure of about 1.0 in. Hg is applied. (see [Note: on page H-2](#)) A leak between the analyzer and the check valve will result in an increase in pressure at the analyzer.

Before the LIT test can be performed, the Vertex M and the external plumbing must be “characterized”. This process involves measuring the sample pressure when the tubes are known to be leak-free and otherwise correct. It is possible to confirm that a tube is leak-free by plugging the end and observing the sample flow decrease to zero. During the characterization process, the Vertex M records the observed sample pressure. Later LIT tests will issue a fault if the sample pressure increases significantly. Performing the characterization without a leak check invalidates the LIT.

Note:

In this document all pressures are given in inches of mercury. This may be converted to kilopascals by multiplying by 3.38. Furthermore, all pressures are reported as gauge pressure, not as vacuum. Using this nomenclature, the effect of a sample line leak is described as a pressure increase instead of a vacuum decrease.

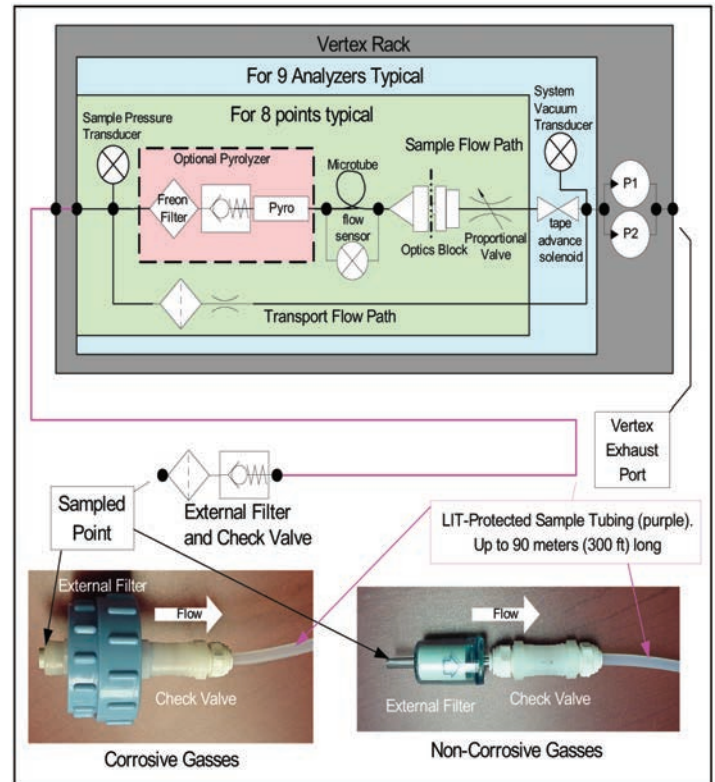

Figure A-1. Simplified Pneumatic Schematic

In practice, the sample pressure measurements are made as a differential measurement with the pump on and then off. This eliminates the effect of any transducer offset. However, since analyzers share a pump, performing the LIT requires that all analyzers stop monitoring. Pressures throughout the Vertex M are allowed to stabilize for 30 seconds before taking

any measurements. An LIT causes monitoring to be interrupted for about two minutes because of synchronization delays.

The test is not compatible with shared sample lines.

The use of external filters is mandatory with Vertex M LIT as it is with all Vertex M points. [Appendix B Specifications](#) and [Section B.2 Filter Compatibility](#) contains guidance on filter selection.

Quantitative Performance

The pressure at the pump inlet must be less than -7.0 in Hg or the test will be inhibited. The sample line must be 4.8 mm ID [thin wall or 0.190 inch ID] and have a length of 90 meters or less. This supersedes table B-2 in Appendix B, Specifications.

The total gas flow (transport plus sample) is typically 1.3 liters per minute per point. This results in a differential pressure of about 1.2 in. Hg with the maximum tubing length. The check valve increases the differential pressure by an additional 1.0 in. Hg for a total of about 2.2 in Hg.

During characterization the differential pressure must be 0.8 in. Hg or more or a fault will be issued. During LI testing the differential pressure must be at least 70% of the characterization differential pressure or more or a fault will be issued. Leaks of 1 mm [0.039 inch] diameter or larger will cause a substantial decrease in the differential pressure and the generation of a fault.

The LIT measurement requires that the total pressure variance of the sampled point, the Vertex M rack and the exhaust outlet must be less than 0.3 in. Hg. for correct operation. See [Figure H-2](#).

Software Overview

Automatic LI tests can be scheduled to take place at any of the times when a time weighted average (TWA) is recorded. TWAs are recorded every eight hours so that up to three LI tests can be performed per day. As with previous software, the time of the TWA can be shifted up to eight hours so that the LI test time can be any time of day. The LI test can be disabled on a per-point basis to permit a rack with LIT to have some tube configurations that are incompatible with LIT.

Buttons are provided to start an LI characterization or an unscheduled test. These two buttons are on the RS View “Authorized Service” screen.

Accessing LIT Parameters

A checkbox on the Configure Point screen as highlighted by the red rectangle in Figure H-2, enables the selected analyzer to participate in the LIT. By default, all analyzers purchased with this option will participate. Clearing this checkmark removes the analyzer from the LIT and prevents the generation of LIT-related faults for the associated point. Otherwise, nuisance faults may be generated for points with incompatible external components. Examples include tubes longer than 90m, medium-walled tubing, and shared sample lines.

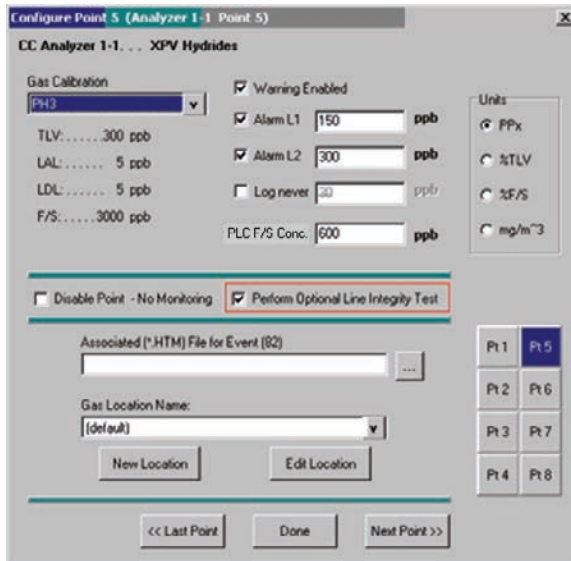

Figure A-2. LIT Access

Pressing the “Line Integrity Test” button shown in [Figure H-3](#) causes the form shown in [Figure H-4](#) to appear.

The three times displayed on the left of the new tabsheet indicate the TWA times. (TWA times are set on Data Logging tabsheet.)

The checkbox and labels on the right of the new page will become black if any of the left-side checkboxes are checked. Otherwise the right-side items will become gray.

The checkmark itself indicates the status of the point-specific checkboxes shown in Figure H-2. If the point-specific LIT checkboxes are all set, this checkmark will be set.

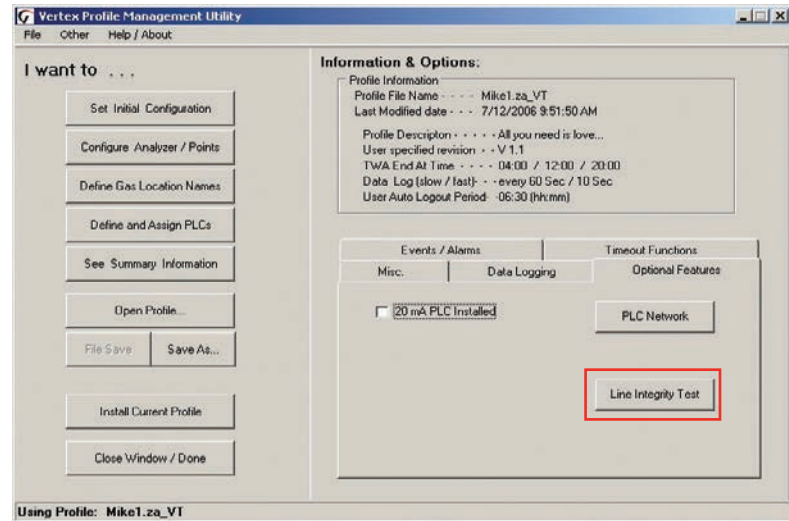

Figure A-3. Configuration Editor New Button

LIT Access from the HMI

The HMI has two buttons.

- Two buttons in the Authorized Service screen as shown in [Figure H-3](#). When the associated analyzer is in Monitor mode this will appear as shown in [Figure H-4](#).



Figure A-4. LIT Access from Authorized Service Mode

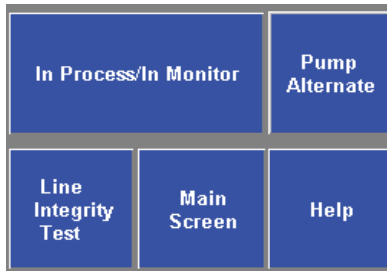

Figure A-5. LIT Access from Monitor Mode

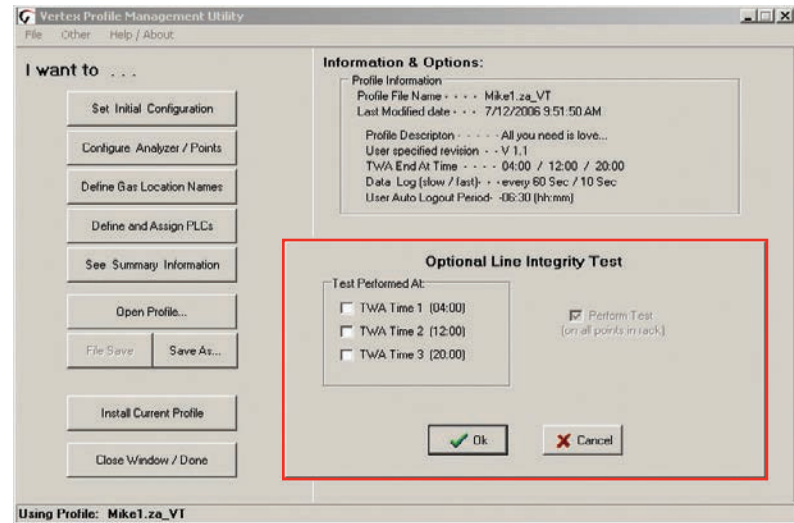

Figure A-6. Configuration Editor New Page

Pressing the “Record Known Good LITC” button will cause a characterization to be performed on all analyzers in the rack. Similarly, pressing the “Line Integrity Test” button will cause a line integrity test to be performed immediately. This is in addition to the LITs which are scheduled by the checkboxes in [Figure H-6](#).

During a LIT test or characterization, the HMI analyzer status display will change from “MONT” or “IDLE” to “LIT”

LIT Related Events

The Vertex M is capable of creating four Maintenance Faults 122 through 125 as shown in [Section 6.3 Maintenance Faults](#).

If the LIT generates Event 124, care must be taken to inspect the integrity of the sample line tubing along its length as the monitored sample may be taken from the break in the tubing, not from the intended area.

The Vertex M is also capable of five new informational events as listed in [Section 6.5 Information Events](#).

Note :

If additional or replacement Vertex M Analyzers are purchased without specifying the LIT option, no faults will be generated for the lack of the option in the new analyzer. However, an “INFO” message will be logged in the Event History each time the LIT option is invoked. Existing analyzers configured for LIT will be unaffected.

A Warranty Statement

Chemcassette® Device Warranty Statement

All products are designed and manufactured to the latest internationally recognized standards by Honeywell Analytics under a Quality Management System that is certified to ISO 9001.

As such, this monitor (including the pump) is warranted under proper use, to the original end-user purchaser, against any defects in materials or workmanship related failures for a period of 12 months from the date of first turn-on or 18 months from delivery from Honeywell Analytics to the customer, whichever is less. Separate warranty conditions apply to the sensor cartridges limited as indicated below. During this period, Honeywell Analytics will repair or replace defective parts on an exchange basis, F.O.B. to approved service centers on a global basis.

This warranty does not cover damage caused by accident, abuse, abnormal operating conditions or extreme poisoning of the sensor cartridge.

Defective equipment must be returned to Honeywell Analytics for repair. Before returning materials for repair or replacement, the Customer must obtain a Service Event Number (SE#) by contacting Honeywell Analytics Service in advance; include a detailed report stating the nature of the defect and ship the equipment prepaid to Honeywell Analytics' factory. If no detail report is included, Honeywell Analytics reserves the right to charge an investigative fee (prices available upon request) before any repair or replacement is performed. Returned goods must detail the Service Event Number (SE#) clearly on the package.

Service in the field or at the customer's premises is not covered under these warranty terms. Time and travel expenses for on-site warranty services will be charged at Honeywell Analytics' normal billing rates. Contact your Honeywell Analytics representative for information on available Service Contracts.

Honeywell Analytics shall not be liable for any loss or damage whatsoever or howsoever occasioned which may be a direct or indirect result of the use or operation of the Contract Goods by the Buyer or any Party.

This warranty covers the gas detector and parts sold to the Buyer only by authorized distributors, dealers and representatives as appointed by Honeywell Analytics. This warranty does not cover defects attributable to improper installation, repair by an unauthorized person or the use of unauthorized accessories/parts on the product. A warranty claim will only be accepted if a proof of purchase is submitted and all conditions obtained within this Warranty are met.

Honeywell Analytics reserves the right to validate any warranty claim prior to processing. Upon acceptance of a warranty claim, Honeywell Analytics will repair or replace the defective product free of charge. The initial warranty period is not extended by virtue of any works carried out there after.

Monitors which have been repaired or replaced during the warranty period are warranted for the remainder of the unexpired portion of the original warranty period. Honeywell Analytics is released from all obligations under its warranty in the event repairs or modifications are made by persons other than its own authorized personnel, unless such work is authorized in writing by Honeywell Analytics. Honeywell Analytics is released from all obligations under its warranty in the event that

detection substrates other than Honeywell Analytics' Chemcassettes® have been installed and used in Honeywell Analytics' monitors.

Honeywell Analytics reserves the right to change this policy at any time. Contact Honeywell Analytics for the most current warranty information.

Chemcassette® Warranty

All Chemcassettes® are warranted for a period not to exceed the Chemcassette® expiration date printed on each package, and tape reel.

Find out more

sps.honeywell.com

Americas

Honeywell Analytics
405 Barclay Boulevard
Lincolnshire, IL 60069
United States
Tel: +1 847 955 8200
Toll free: +1 800 538 0363
Fax: +1 847 955 8208
detectgas@honeywell.com



Europe, Middle East, and Africa

Life Safety Distribution AG
Javastrasse 2
8604 Hegnau
Switzerland
Tel: +41 (0)44 943 4300
Fax: +41 (0)44 943 4398
gasdetection@honeywell.com

Asia Pacific

Honeywell Industrial Safety
7F SangAm IT Tower
434 Worldcup Buk-ro, Mapo-gu
Seoul 03922
Korea
Tel: +82 2 6909 0300
VOIP: +8 5401 0321
Mobile: +82 10 2512 6117
Fax: +82 2 6909 0329
analytics.ap@honeywell.com

Technical Services

ha.global.service@honeywell.com

www.honeywell.com

Honeywell

1998M0759
Revision 18
March 2023
©2023 Honeywell