

CSA / UL Certification Label

Honeywell Analytics Inc., Lincolnshire. Made in USA
 TERMINATION UNIT TYPE DX100(I)
 PART No. 2104BXXXX

CLASSIFIED AS TO FIRE, ELECTRICAL SHOCK & EXPLOSIVE HAZARDS ONLY. FOR USE IN CLASS 1, GROUPS B,C,D. PROVIDES INTRINSICALLY SAFE CIRCUITS WHEN INSTALLED IN ACCORDANCE WITH CONTROL DRGS. 2104E0025 (CSA) OR 2104E0015 (UL)

Ser.No. _____

Amb.Temp.Range
 -25°C to +40°C (UL) V max: 32Vdc
 -55°C to +40°C (CSA) I max: 2A

AVERTISSEMENT: LA SUBSTITUTION DE COMPOSANTS PEUT COMPROMETTRE LA SECURITE INTRINSEQUE.

WARNING: SUBSTITUTION OF COMPONENTS MAY IMPAIR INTRINSIC SAFETY.

11

UL Control Drawing

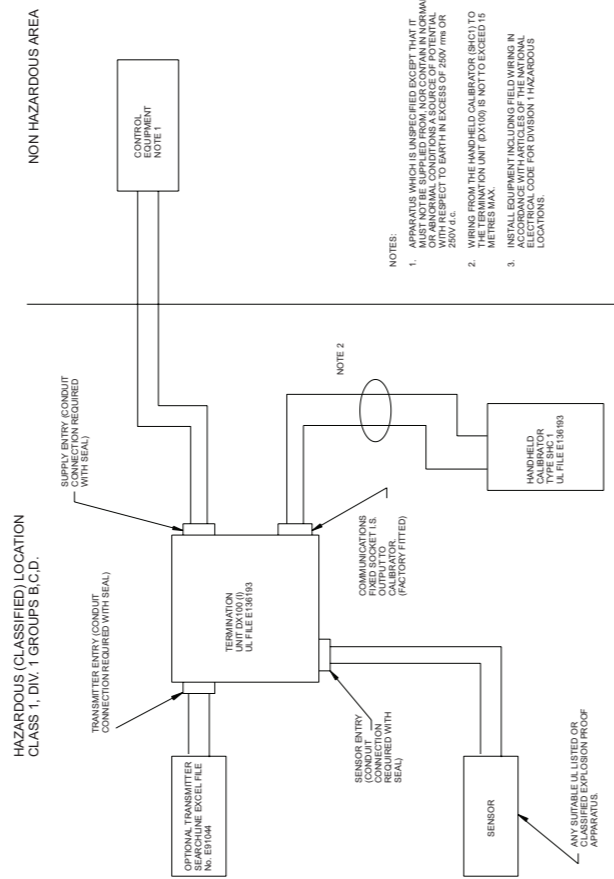

12

CSA Control Drawing

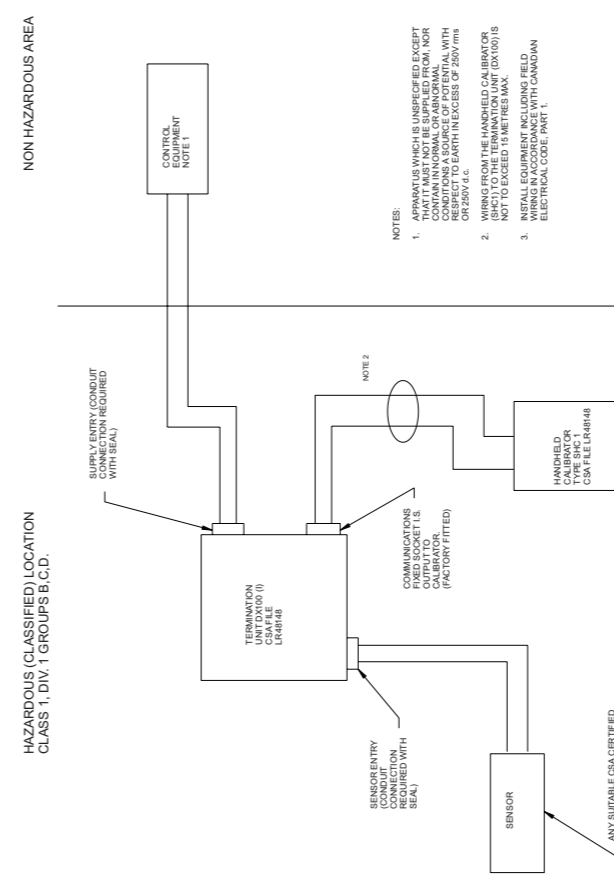

13

14

Quick Start Guide

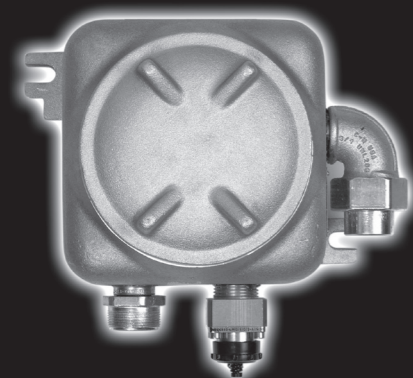

DX100 (I) Termination Unit

1. INTRODUCTION

The DX100 (I) Termination Unit is an explosion proof junction box that provides a signal connection point and mounting point for the Honeywell Analytics Searchpoint Optima or Optima Plus gas detectors.

Caution: The DX100 (I) Termination Unit can only be used with Searchpoint Optima or Optima Plus gas detectors.

This guide covers the basic on-site mechanical and electrical installation of the unit. Refer to the DX100 Series Termination Units Technical Handbook (Part No: 2104M0701) for more detailed information about the DX100 (I).

The unit is certified to UL and CSA standards and is intended for use in hazardous environments. The DX100 (I) provides:

- terminals for connecting the gas detector and the field cabling
- an Intrinsically Safe (IS) connection point for the Hand Held Interrogator (SHC1)
- a local mounting point for the Searchpoint Optima or Optima Plus gas detector

The unit features:

- three 3/4" NPT cable/conduit entries
- two terminal blocks
- a voltage clamp and a communications link entry socket

One of the three cable/conduit entries (usually the left-hand one) is used to mount the Searchpoint Optima or Optima Plus gas detector directly to the box. The Optima and Optima Plus output a 4-20mA signal that is sent via the Termination Unit field wiring back to the controller.

The voltage clamp and the external socket provide the IS connection to the Handheld Interrogator (SHC1).

The SHC1 allows the operator to communicate with the attached gas detector to commission, calibrate or diagnose the system.

Full details about the Searchpoint Optima and Optima Plus units can be found in their documentation, which includes operation of the SHC1.

Caution: Only the SHC1 Handheld Interrogator must be connected to the DX100 (I) Communications Link Entry Socket.

Honeywell Analytics Limited reserve the right to change or revise the information supplied in this document without notice and without obligation to notify any person or organization of such revision or change. If further details are required that do not appear in this document contact Honeywell Analytics Limited or one of its agents.

1

2. SAFETY

Ensure that you read and understand this document **BEFORE** installing/operating the equipment. Pay particular attention to the Safety Warnings.

WARNINGS

1. The DX100 (I) Termination Unit is certified for and intended for use in potentially hazardous areas. Install and use the DX100 (I) Termination Unit in accordance with the latest regulations. No modifications to the unit is permitted without reference to the relevant certifying authority
2. Install UL approved and certified equipment including field wiring in strict accordance with the articles of the National Electrical Code for Division 1 Hazardous Locations (NFPA 70).
3. Install CSA approved and certified equipment including field wiring in strict accordance with Canadian Electrical Code, Part 1.
4. For installations elsewhere, the appropriate local or national regulations should be used.
5. The Code of Practice regarding Selection, Installation, Use And Maintenance Of Apparatus For The Detection Of Combustible Gases (Other Than For Mining Applications Or Explosive Processing And Manufacture) must be complied with.
6. The DX100 (I) Termination Unit must be properly earthed to protect against electrical shock, minimise electrical interference and comply with IS Safety Requirements.
7. Dismantling or repair of equipment should be carried out in the safe area only.
8. Do not drill holes in the housing as this will invalidate the explosion protection.
9. In order to maintain electrical safety, the unit must not be operated in atmospheres with more than 21% oxygen.
10. Do not open the enclosure in the presence of an explosive atmosphere.

CAUTIONS

1. Only the Handheld Interrogator (SHC1) must be connected to the Termination Unit's communication link entry socket.
2. The DX100 (I) Termination Unit can only be used with Searchpoint Optima or Optima Plus gas detectors.

2

Please Note:
 While every effort has been made to ensure accuracy in this publication, no responsibility can be accepted for errors or omissions. Data may change, as well as legislation, and you are strongly advised to obtain copies of the most recently issued regulations, standards, and guidelines.
 This publication is not intended to form the basis of a contract.
 © 2005 Honeywell Analytics

Find out more at:
www.honeywellanalytics.com

Contact Honeywell Analytics:

Europe, Middle East, Africa
 Life Safety Distribution GmbH
 Javastrasse 2
 8604 Hegnau
 Switzerland
 Tel: +41 (0)44 943 4300
 Fax: +41 (0)44 943 4398
gasdetection@honeywell.com

Customer Service:
 Tel: 00800 333 222 44 (Freephone number)
 Tel: +41 44 943 4380 (Alternative number)
 Fax: 00800 333 222 55
 Middle East Tel: +971 4 450 5800 (Fixed Gas Detection)
 Middle East Tel: +971 4 450 5852 (Portable Gas Detection)

Americas
 Honeywell Analytics Inc.
 405 Barclay Blvd.
 Lincolnshire, IL 60069
 USA
 Tel: +1 847 955 8200
 Toll free: +1 800 538 0363
 Fax: +1 847 955 8210
detectgas@honeywell.com

Asia Pacific
 Honeywell Analytics Asia Pacific
 #701 Kolon Science Valley (1)
 34 Worldcup Buk-ro, Mapo-gu,
 Seoul 03922,
 Korea
 Tel: +82 (0)2 6909 0300
 Fax: +82 (0)2 2025 0328
 India Tel: +91 124 4752700
analytics.ap@honeywell.com

Technical Services
 EMEA: HAexpert@honeywell.com
 US: ha.us.service@honeywell.com
 AP: ha.ap.service@honeywell.com
www.honeywell.com

Issue a3 03/2017
 H_MAN0618_V1
 2140M0702
 © 2017 Honeywell Analytics



3. MAIN FEATURES

This section identifies the main features of the Termination Unit and also details important dimensions for the unit when installing.

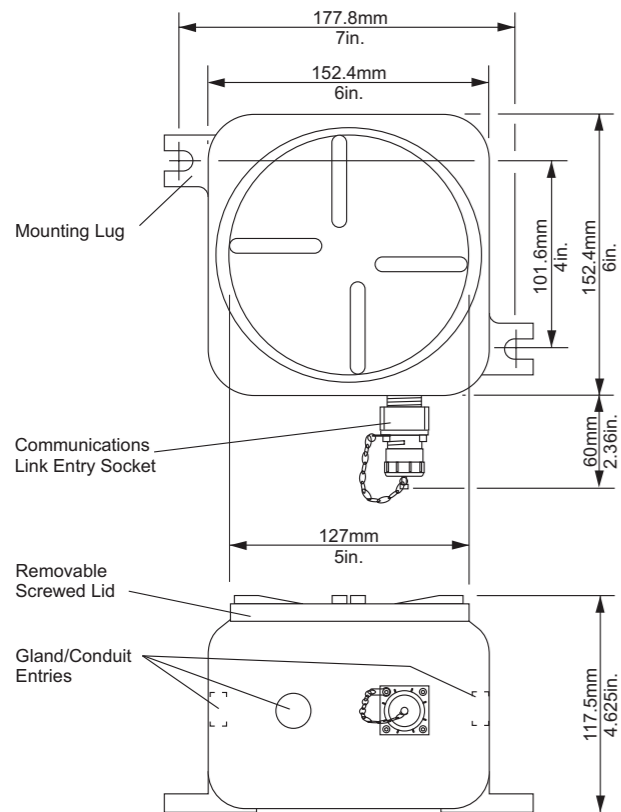

3

4. INSTALLATION

It is important before starting these procedures that the detailed information provided in the DX100 Series Termination Units Technical Handbook about DX100 (I) installation has been carefully considered at the planning stage.

The following points should be noted.

General Installation Guidelines

1. Read the Warnings and Cautions at the beginning of this document and all the relevant instructions before starting any of the installation procedures.
2. Identify external cable requirements and the necessary cable entry ports to be used on the Termination Unit.
3. Refer to the documentation for the associated control system for details about external network connection information, field wiring, interconnections, etc.
4. Refer to the associated Searchpoint Optima handbook for details about the gas detector.

MECHANICAL INSTALLATION

Mechanical Installation Guidelines

1. Identify a suitable location where the Termination Unit can be mounted. The unit should be fitted to a flat surface.
2. When fitting a Termination Unit consideration should be made regarding the probability of mechanical impacts and interference from other equipment and apparatus.

Procedure

This procedure describes how the DX100 (I) is installed at the mounting location and then the Optima gas detector is fitted to the Termination Unit.

- (1) Securely fit the Termination Unit at the required monitoring point.
Use the two Termination Unit mounting lugs. Ensure the communications link entry socket connector is located at the bottom. This is to fulfil the requirement to position the Optima sensor horizontally so that the risk of fouling the gas detector's optical surfaces is reduced.
- (2) Remove the Termination Unit lid.
Use the lugs on the lid to unscrew it anticlockwise from the Termination Unit base.

4

INSTALLATION

- (3) Fit the Optima or Optima Plus detector to the left-hand entry.
First remove the 3/4 NPT approved blanking plug.
- (4) Fit approved certified 3/4 NPT cable glands or conduit fittings to the Termination Unit cable/conduit entries as required.
- (5) Fit the external field wiring through the cable/conduit fittings and secure.
- (6) Terminate the Optima and field wiring.
Refer to Electrical Installation.

The diagram shows a typical Searchpoint Optima Plus and DX100 (I) installation.

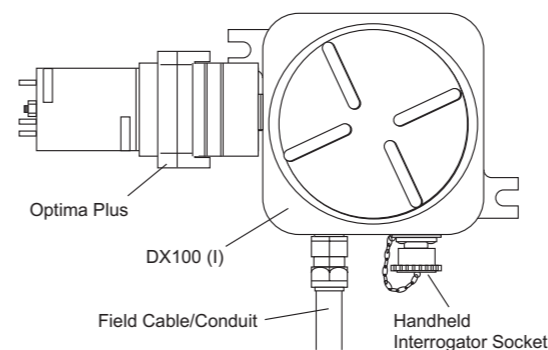

5

INSTALLATION

ELECTRICAL INSTALLATION

Electrical Installation Guidelines

1. Isolate all associated power supplies and ensure that they remain **OFF** during the procedures.
2. Ensure that approved and certified cable glands have been fitted to the Termination Unit cable entries where used for field wiring, with sealing washers where necessary to maintain the ingress protection rating.
3. Ensure that any cable gland/conduit locking rings are fitted before terminating the cables.
4. Make sure that a conduit sealing fitting is installed within 460mm (18in.) of the Termination Unit on all conduit runs.

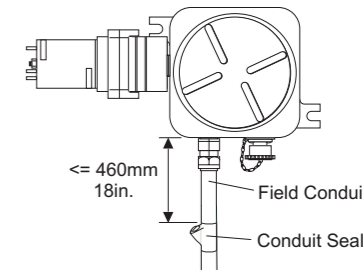

5. Ensure that approved and certified blanking plugs are fitted to all unused Termination Unit cable entries.
6. The Termination Unit mounting plate must be bonded to a protective earth.
7. Suitable crimps and/or ferrules must be fitted when connecting more than one wire to a Termination Unit terminal.
8. The field terminals of the Termination Unit accept single or multi-stranded wire from 22-12 AWG (0.326 to 3.31mm²). Cables should be routed carefully to avoid physical and environmental hazards such as mechanical stress and high temperatures.
9. In order to ensure correct operation and to meet requirements for RFI and EMC, it is recommended that all field cables are screened with the cable screen connected at one end only (see the DX100 Series Technical Handbook for further details - Part No: 2104M0701).

6

INSTALLATION

Procedure

Connect the gas detector and field wiring to the terminal blocks in the DX100 (I) Termination Unit according to the following wiring diagram and table.

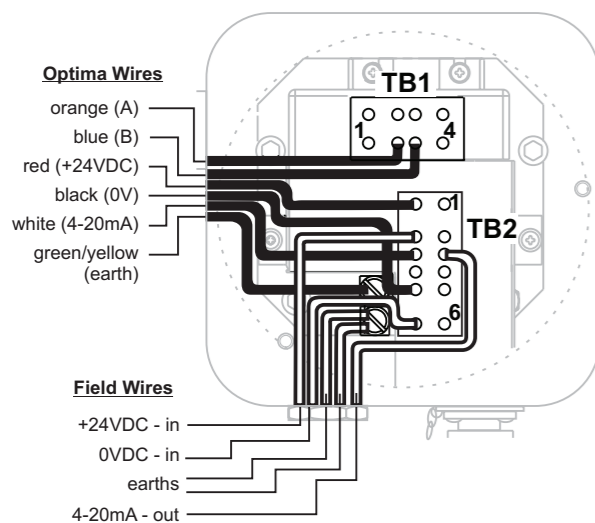

7

INSTALLATION

Terminal/Number	Gas Detector Wiring		Field Wiring
	Function	Colour	
TB1	1	-	-
	2	A	Orange
	3	B	Blue
	4	-	-
TB2	1	+24VDC	Red
	2	-	+24VDC - Supply
	3	4-20mA	White
	4	-	-
	5	0V	Black
	6	-	0V - Supply
Earth Posts	-	Earth	Green/Yellow
			Earth Barrier Earth

8

5. SPECIFICATIONS

Connections

Inputs

Searchpoint Optima
Searchpoint Optima Plus
Field wiring.

Outputs

IS protected SHC1 Handheld Interrogator communications (RS485)
4-20mA (Non-isolated).

Power Supply

18-32VDC.

Environmental

Operating temperature

UL -25°C to 40°C (-40°F to 104°F).
CSA -55°C to 40°C (-67°F to 104°F).

Enclosure

Entry Socket

One IS protected Communications Link Entry Socket for connecting the SHC1 Handheld interrogator.

Cable/Conduit Entries

Three 3/4 NPT entries (one each side and one in the bottom) to accept gas detector and field cabling or 3/4" conduit.

Size

212mm (8.35in.) wide x 152.4mm (6in.) high x 117.5mm (4.625in.) deep. Add approximately 60mm (2.36in.) to the height for the Communications Link Entry Socket.

Weight

2.5kg.

Material

Aluminium.

Ingress Protection

IP66 to BS EN 60529:1992, Degrees of protection provided by enclosures (IP code).

Certification

UL Class 1, Div 1, Groups B, C, D
CSA Class 1, Div 1, Groups B, C, D (see 6. Certification for details)

Field Wiring

22-12 AWG (0.326 to 3.31mm²), 105C

9

6. CERTIFICATION

This section specifies UL and CSA certification information for the DX100 (I) Termination Unit. It includes relevant Control Drawings.

A Honeywell Analytics certification label is located on the right-hand side of the DX100 (I) Termination Unit.

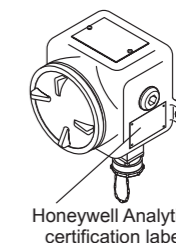

The label contains all the relevant information regarding the product's identification and certification state.

The part number of the certified UL/CSA DX100 (I) Termination Unit is 2104B2381.

The following diagrams show the Honeywell Analytics UL and CSA Certification Labels. The label content for the CSA label is explained. The UL label is similar.

10