

RAELink3 User's Guide



Rev. B
August 2011
P/N 029-4508-000

Contents

1	Regulatory Information	3
2	Standard Contents	6
3	General Information.....	6
3.1	Configuration Options	6
3.1.1	Connection With Third-Party Devices	7
3.2	Key Features	8
4	Specifications.....	9
5	Charging The Battery	10
5.1	Detaching The Charging Adapter	11
5.2	Replacing The Li-ion Battery	12
5.3	Alkaline Battery Adapter	12
5.4	User Interface.....	14
6	Backlight.....	15
7	Display.....	15
8	Operating The RAELink3.....	16
9	Modes Of Operation	16
9.1	Host Mode.....	17
9.2	Remote Mode.....	17
9.3	Repeater Mode	18
10	Turning The RAELink3 On.....	19
11	Turning The RAELink3 Off	20
12	Configuring The RAELink3	20
12.1	Accessing Programming Mode.....	20
12.2	Setting The Network ID.....	21
12.3	Setting The Operation Mode.....	23
12.3.1	Remote Mode's Bluetooth And Cable Sub-Modes	24
12.3.2	Simultaneous BT And Cable Operation	27
12.4	GPS Power Control.....	30
12.5	GPS Coordinates Check.....	31
12.6	Bluetooth Power Control	33
12.7	Setting The Unit ID.....	33
12.8	Modem Configuration Menu	36
13	Connecting A RAELink3 Remote Via Bluetooth.....	36
14	Connecting A RAELink3 Remote Via Cable.....	39
14.1	GPS And Unobstructed Line Of Sight.....	40
14.2	Cleaning The RAELink3	41
14.3	Ordering Replacement Parts	41

14.4 Special Servicing Note..... 41
15 Troubleshooting..... 42
16 Technical Support..... 43
17 RAE Systems Contacts..... 44

1 Regulatory Information

CAUTION!

To reduce the risk of electric shock, never open the modem cover during normal operation. This modem is certified to be used in Class I, Division 2 hazardous locations.



WARNINGS



Use only RAE Systems supplied charging adapter to charge the rechargeable battery pack inside the modem. Use only RAE Systems Lithium-Ion battery pack 029-3501-000 or alkaline battery pack, 029-3502-000. Recharge/replace batteries only in non-hazardous locations. The serial connection port may not be used in hazardous area.

STATIC HAZARD: Clean only with a damp cloth.

For safety reasons this equipment must be operated and serviced by qualified personnel only. Read and understand instruction manual completely before operating or servicing.

Specifications

Dimensions	4.73" x 3.4" x 1.85" (120 mm x 86 mm x 48 mm)
Weight	17.3 oz (490 g)
Battery	Rechargeable 7.4V Lithium-Ion battery pack Alkaline battery pack (7.5V, five alkaline batteries)
LCD Display	Backlit with icons and text
Attachment	Belt Clip
Temperature	-20° C to 55° C (-4° F to 131° F)
Humidity	0% to 95% relative humidity (Non-condensing)
Safety Certification	Class I, Division 2, Groups A, B, C, D, T4

For rechargeable battery pack, 029-3501-000:



WARNING



To reduce the risk of ignition of hazardous atmospheres, recharge/replace battery only in area known to be non-hazardous.

Ne charger les batteries que dans l'emplacement désigné non dangereux.

For alkaline battery pack, 029-3502-000:

Note: Do not mix old and new or different types of batteries. Do not change batteries in hazardous locations.

Antenna Lock

Caution: To reduce risk when operating in potentially explosive atmospheres, ensure the antenna is locked in place with set-screw to prevent inadvertent disconnection.

Note: Antenna must be locked in place with set-screw

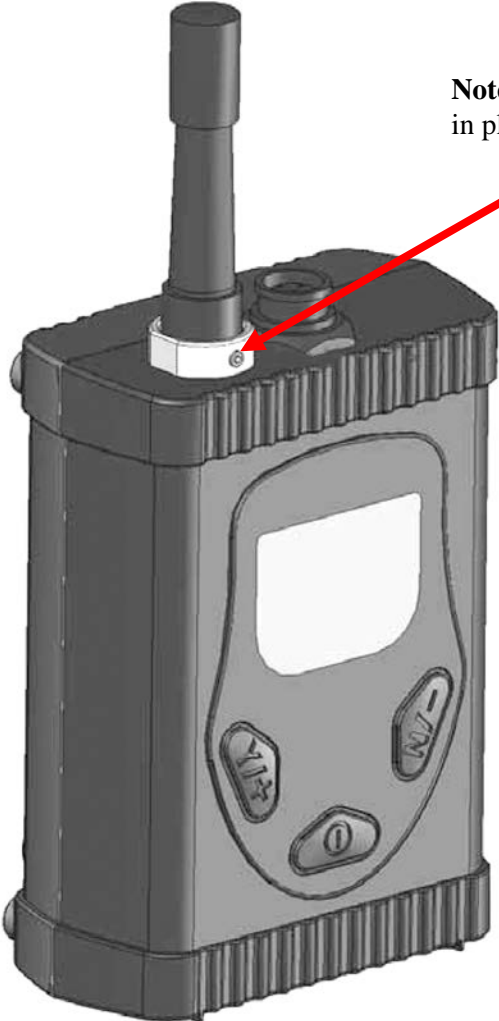

2 Standard Contents

- RAELink3
- Charging adapter with AC cable
- Alkaline battery adapter
- RS-232 computer interface cable
- Coiled serial cable (for connection to devices without Bluetooth)
- RAELink3 Quick Reference Guide
- RAELink3 Resource CD
- Whip antenna (for use when RAELink3 is in Remote Mode)
- 5dBi antenna with 12' cable and magnetic mount (for use when RAELink3 is in Host or Repeater mode)
- Hard transport case

3 General Information

The RAELink3 is a compact, portable radio-frequency modem that provides long-range wireless communication between remote portable gas monitors (PGMs) such as RAE Systems' ppbRAE 3000, MultiRAE Plus, etc., and a base station/computer for comprehensive monitoring. Up to 64 monitors equipped with RAELink3 units can be networked with a single Host. In addition, for applications requiring long-distance monitoring or monitoring in locations with obstructions to clear line-of-sight communication, RAELink3s configured as Repeaters extend the effective reach of the system.

3.1 Configuration Options

The RAELink3 can be configured to act in one of the following three modes:

1. Remote. The RAELink3 Remote functions as a slave modem and communicates to a host modem with the same network ID.

2. Host. The RAELink3 Host functions as a host modem and communicates with multiple wireless modems (such as the RAELink3 Remote and RAELink3 Repeater, as well as AreaRAE

RAELink3 User's Guide

products equipped with RAELink-family Remote Modems) with the same network ID.

3. Repeater. The RAELink3 Repeater functions as a repeater for RAELink3 Remote slave modems (or AreaRAE or RAELink series products) with the same network ID.

3.1.1 Connection With Third-Party Devices

The RAELink3 can be configured as a slave modem to communicate sensor data from select 3rd party monitors back to a host modem with the same network ID. Third-party monitors available to choose from include ChemRAE, BioHarness, DustTrak2, and AP4C.

Note: Some third-party monitors require custom cable for connection with RAELink3.

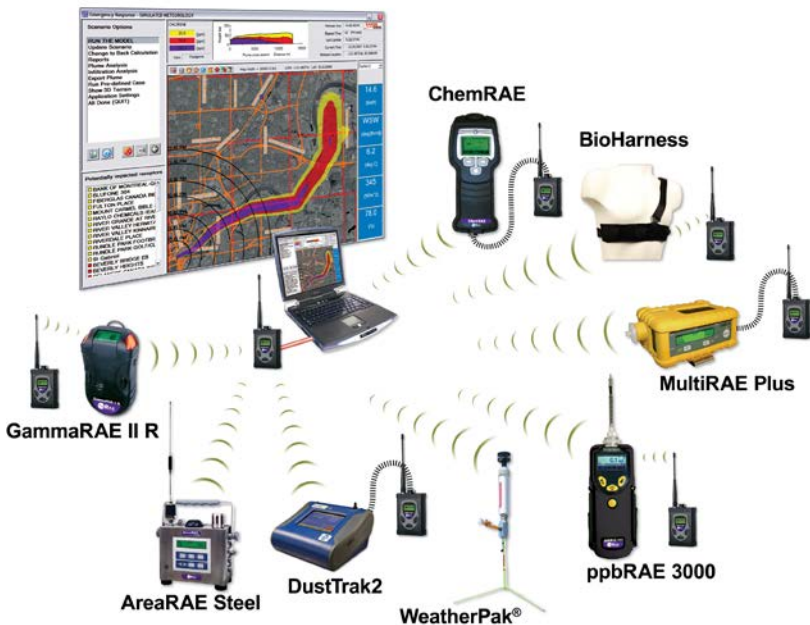

RAELink3 User's Guide

3.2 Key Features

- Onboard long-range license-free radio for transmission of data up to 2 miles
- Onboard microcomputer provides flexible protocol translation in order to interface to most monitoring devices via a serial port
- Onboard Bluetooth master provides Bluetooth wireless connection with other Bluetooth devices
- Onboard GPS receiver provides global positioning capability
- Onboard LCD displaying radio signal strength, GPS tracking status, and battery life
- Long operating time from built-in rechargeable Li-Ion battery pack (up to 18 hours of continuous operation)

Note: Two monitors can connect to one RAELink3 using a Bluetooth and serial cable connection.

4 Specifications

Dimensions	4.73" x 3.4" x 1.85" (120 mm x 86 mm x 48 mm)
Weight	17.3 oz (490 g)
Battery	Rechargeable 7.4V/1650mAh Lithium-Ion battery pack Alkaline battery pack (7.5V, five alkaline batteries)
Operating Time	Up to 18 hours of continuous operation.
LCD Display	Backlit with icons and text
Keypad	3 keys: Y/+, N/-, and MODE
Sensitivity	-108dBm at 10^{-6} bit error rate
Data Rate	Up to 115.2 kbps
Error Detection	32 bps CRC, retransmit on error
Data Interface	Bluetooth, RS-232
GPS Accuracy	Within 5 meters
Temperature	-20° C to 55° C (-4° F to 131° F)
Humidity	0% to 95% relative humidity (Non-condensing)
IP Rating	IP-65
Safety Certification	Class I, Division 2, Groups A, B, C, D, T4

5 Charging The Battery

It is recommended to fully charge the battery before using the RAELink3. The Li-ion battery is charged by attaching the instrument to the Charging Adapter.

Follow this procedure to charge the instrument:

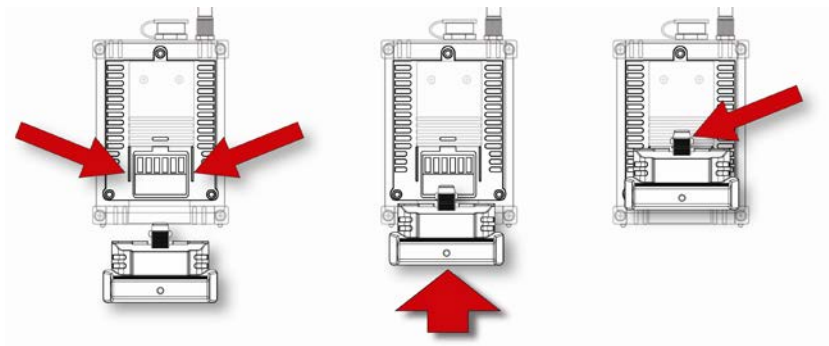

1. Align the Charging Adapter with the back of the RAELink3 (two guides match indents on the back of the Charging Adapter).
2. Slide the Charging Adapter onto the back of the RAELink3.
3. Make sure the latch clicks into place.
4. Plug the power supply's barrel connector into the input on the side of the Charging Adapter.
5. Plug the power supply into the wall outlet.

The LED Charging Indicator in the Charging Adapter should glow red to indicate it is charging, and glow green when the battery is fully charged.

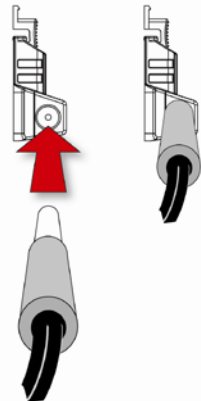
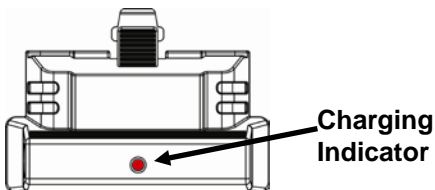

5.1 Detaching The Charging Adapter

To detach the Charging Adapter, press in on the latch. While pressing the latch, slide the Charging Adapter down.

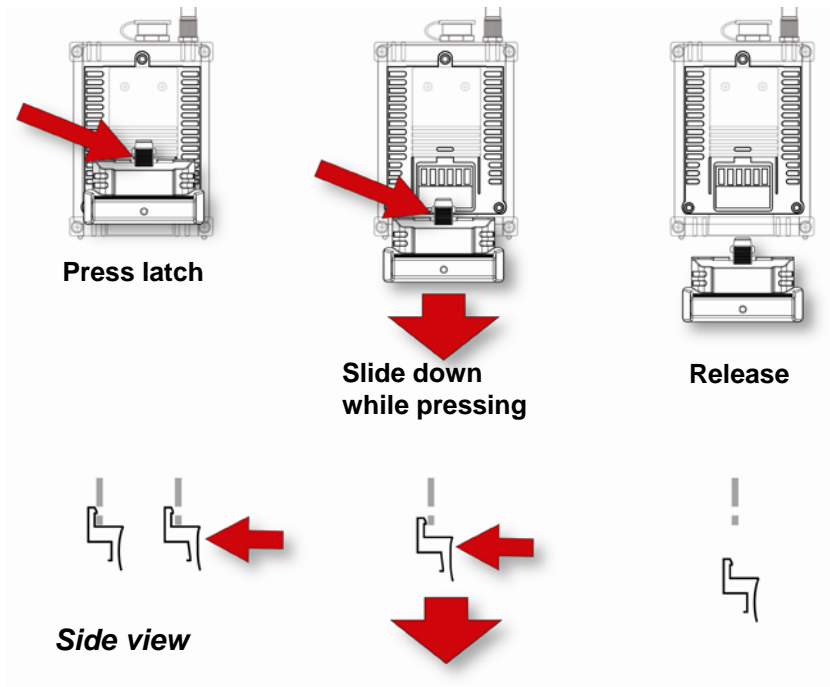

RAELink3 User's Guide

5.2 Replacing The Li-ion Battery

1. Turn off the instrument.
2. Located on the rear of the instrument are three screws. Loosen all three screws, and lift the battery out of the RAELink3. Remove the battery pack from the battery compartment by lifting it out.

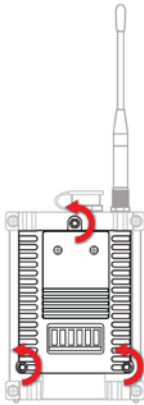

**Loosen
Screws**

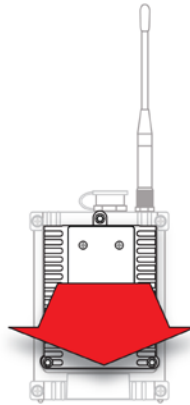

**Lift
Battery**

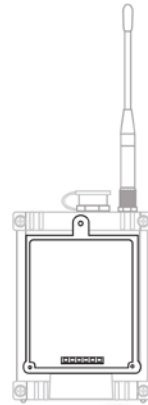

**Remove
Battery**

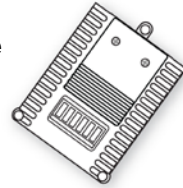

3. Replace a fully charged spare battery pack inside the battery compartment. Make sure the battery pack is oriented properly inside the compartment.
4. Press the battery into place with your hand, and then tighten the three screws.

5.3 Alkaline Battery Adapter

An alkaline battery adapter is supplied with the RAELink3. The adapter (part number 029-3502-000) accepts five AA alkaline batteries (use only Duracell MN1500 or Energizer E91) and provides approximately 12 hours of operation. The adapter is intended to be

RAELink3 User's Guide

used in emergency situations when there is no time to charge the Li-ion battery pack.

To insert batteries into the adapter:

1. Remove the three Philips-head screws to remove the battery (alkaline or rechargeable).
2. Turn over the alkaline battery adapter and remove the two Philips screws.
3. Lift off the cover (there are two small indexing tabs at the end opposite the two screws).
4. Insert five fresh AA batteries as indicated by the polarity (+/-) markings.
5. Replace the cover. Replace the two Philips screws.
6. Set the alkaline battery adapter into the RAELink3.
7. Tighten the three Philips screws.

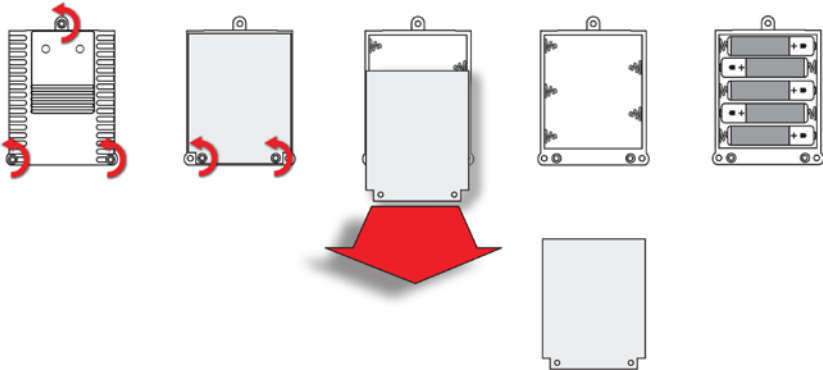

IMPORTANT!

Alkaline batteries cannot be recharged. If you place the RAELink3 in its Charging Cradle, the alkaline batteries will not be recharged.

Note: When replacing alkaline batteries, dispose of old ones properly.

Note: Do not mix old and new or different types of batteries. Do not change batteries in hazardous locations.

5.4 User Interface

The instrument's user interface consists of the display and three keys. The keys are:

Y/+
MODE
N/-

The LCD display provides visual feedback that includes the reading, time, battery condition, and other functions.

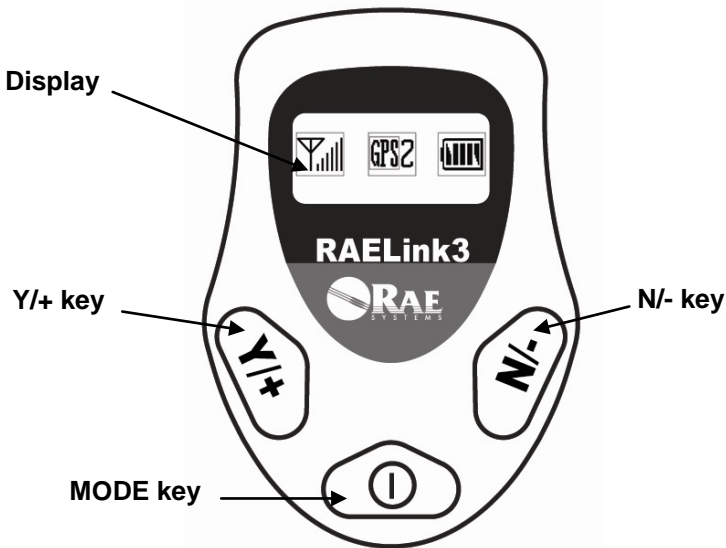

[Y/+] increases values, [MODE] acts as on/off and save, and [N/-] selects “no” and advances to the next function. In addition, [Y/+], [MODE], and [N/-] act as “soft keys” that control different parameters and make different selections within the instrument's menus. From menu to menu, each key controls a different parameter or makes a different selection.

6 Backlight

The LCD display is equipped with an LED backlight to assist in reading the display under poor lighting conditions. Press any key to turn on the backlight. It automatically turns off after 15 seconds.

7 Display

The display shows the following information:

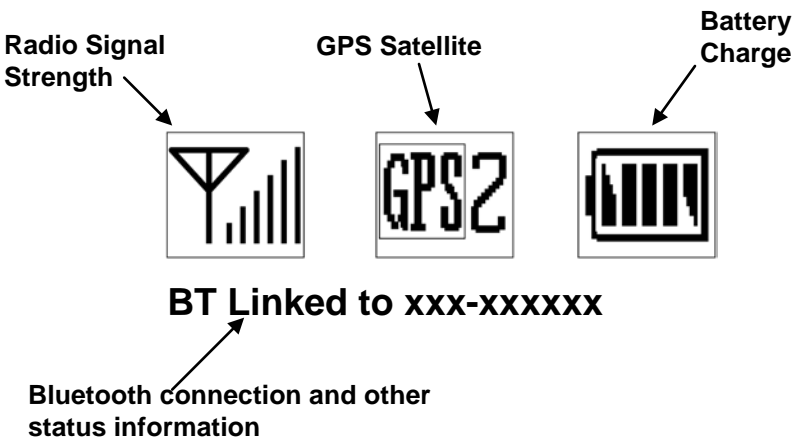

Radio Signal Strength
GPS Satellite

Indicates signal strength in network.
Shows number of GPS satellites that RAE Link3 is receiving data from. (It must see 3 satellites for proper mapping in ProRAE Guardian.

Battery Charge
Bluetooth Connection Status

Indicates battery level via bar graph.
Shows which monitor the RAE Link3 is connected to via Bluetooth.

8 Operating The RAELink3

The RAELink3 operates with two simultaneous modes of data transfer. First, it can use wireless BT (Bluetooth) or a cable to connect to a portable gas monitor or other compatible detector. Second, it uses radio-frequency communication to transmit and receive data with a base station.

The following section covers configuration and operation of the modem portion of the RAELink3. Refer to page 36 for information on establishing a link between a RAELink3 and a portable gas monitor or other detector.

IMPORTANT!

Before operating any RAELink3 modems in the field, test them to make sure they are properly configured for your network.

Each RAELink3 must have the proper network ID so that it is compatible with the AreaRAE wireless monitoring system.

9 Modes Of Operation

The RAELink3 can be configured to operate in one of three modes:

- Host
- Remote
- Repeater

Unless specified otherwise, the RAELink3 is factory-configured to operate in the Remote Mode. You can change the operation mode via the menus that you reach when you enter Programming Mode (see page 20 for details).

RAELink3 User's Guide

9.1 Host Mode

This mode designates the RAELink3 as Host (master) in a network. It can simultaneously communicate with numerous Remotes and Repeaters.

Note: There can only be one Host in a network. It is typically connected to a computer (PC) running ProRAE Guardian software for monitoring.

After the modem is properly configured, connect the serial interface cable to the PC's serial (RS-232) port. If the computer does not have a serial port, use a USB-to-9-pin Serial Adapter (part number 410-0210-000) to connect the cable to the computer. The DB9 connector should be firmly attached to the computer's DB9 serial port (insert the connector into the receptacle and then finger-tighten the connector's two long screws). Connect the other end of the cable to the data connector on the RAELink3. Turn on power to the RAELink3. It is now ready for data communication.

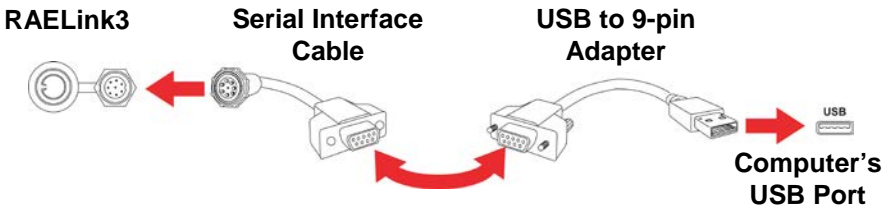

9.2 Remote Mode

In this mode, the modem passes all data from the monitor to the Host. The LCD displays the radio signal strength, GPS satellites, and battery charge. The BT (Bluetooth) connection status is also displayed on the LCD screen.

For BioHarness, ChemRAE, DustTrak2, and AP4C. In these sub-modes of Remote Mode, the modem passes all data from the selected third-party device to a host.

RAELink3 User's Guide

Remote Mode is designed so that a RAELink3 modem can be used as a drop-in replacement for an existing RAELink or RAELink2 modem without modification.

9.3 Repeater Mode

In this mode, the modem functions as a repeater. It does not interpret or process the data that passes through it. Its function is to extend the distance between a Remote and a Host, or to route the signal to deal with obstructions to line-of-sight communication.

10 Turning The RAELink3 On

1. Press and hold [MODE].
2. When the display turns on, release the [MODE] key.

The RAE Systems logo should appear first. (If the logo does not appear, there is likely a problem and you should contact your distributor or RAE Systems Technical Support.) The firmware version is shown, along with the date of installation, and then the RAELink3's serial number.

Once the startup procedure is complete, the instrument shows a numerical reading screen with antenna signal strength, battery capacity, and GPS icons, and (if GPS is turned on) the number of satellites the RAELink3 is receiving positioning data from.



A text line shows the Bluetooth connectivity status and indicates the ID of the last Bluetooth-linked monitor. This indicates that the instrument is fully functional and ready to use.

11 Turning The RAELink3 Off

1. Press and hold the Mode key for 3 seconds. The display shows “Shutting Down...” and a 5-second countdown to shutoff begins.
2. When you see “Unit off...” release your finger from the [MODE] key. The instrument is now off.

Note: You must hold your finger on the key for the entire shutoff process. If you remove your finger from the key during the countdown, the shutoff operation is canceled and the instrument continues normal operation.

12 Configuring The RAELink3

The RAELink3 modem is a programmable “smart” modem that can be configured to operate in Host, Repeater, or Remote Modes. These options are selected in Programming Mode, along with other parameters for setting the Network ID, Unit ID, GPS on/off state, GPS coordinates check, Modem menu and Op Mode, BT, Cable, and BT Power on/off. All configurations are performed using the three front-panel keys and the display.

12.1 Accessing Programming Mode

Note: You can exit Programming Mode at any time by pressing [MODE], except when in the Set Network ID and Set Unit ID menu screens.

With the RAELink3 turned on, press and hold both [MODE] and [N/-] for 3 seconds. The RAELink3 enters programming mode. The Bluetooth communication screen is displayed:

Start BT Search?
* (1) 596-000123
(2) Null

RAELink3 User's Guide

It shows the last Bluetooth pairing ID and asks if you want to search for a connection. (If no connection was recorded, then “Null” is shown.)

Note: When Programming Mode is accessed, the icons are minimized and relocated to the top of the display.

If you want to search for a Bluetooth-equipped monitor and pair with it, press [Y/+]. If not, press [N/-] to move to the next screen. If you want to exit Programming Mode, press [MODE].

12.2 Setting The Network ID

Every AreaRAE network must have a Network ID, which identifies that network and all equipment operating in that network. All RAELink3 (or other RAELink model) Host, Repeater, and Remote wireless modems in the same AreaRAE network need to be configured with the same Network ID.

RAELink3 modems come from the factory programmed to a unique random network ID, or programmed to match an existing system as specified by the customer. To enable a different Network ID, the number must be set to a value between 1 and 4095, *except* 255.

When changing the Network ID, the cursor flashes on the selected digit, highlighting it and indicating that you can change it:

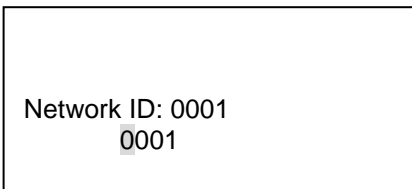

1. Press [Y/+] to increase the number or [N/-] to decrease the number.
2. Press [MODE] to advance to the next digit.
3. Input a network ID (except 255).

RAELink3 User's Guide

To accept the new Network ID, press and hold [MODE] for 2 seconds. A confirmation screen appears, as shown here:

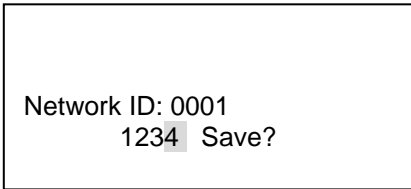

Press [Y/+] to save, or press [N/-] to abort the change.

If you save the Network ID, you see this display as it saves:

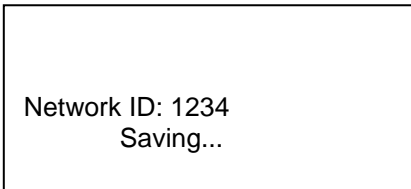

When it is done, the display returns to the Set Network ID screen, showing the new Network ID:

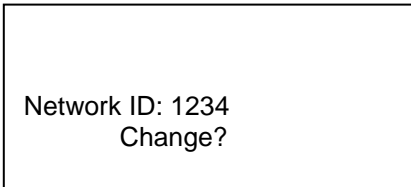

If you want to change the Network ID, repeat the procedure.

To progress to the next screen, Set Operation Mode, press [N/-].

12.3 Setting The Operation Mode

The Operation Mode designates whether the RAELink3 operates as a Host, Remote, or Repeater. In addition, under “Remote” are sub-modes for Bluetooth and Cable connection with local devices such as the BioHarness, GammaRAE 2, ChemRAE, AP4C, DustTrak2, and other cable-connectable point-to-point RAE Systems monitors.

IMPORTANT!

There can only be one Host in a network. If more than one RAELink3 or earlier-generation RAELink wireless modem (or combination) is designated as a Host, the network will not function properly.

The operation mode program screen looks like this:

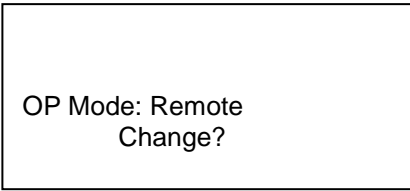

Press [Y/+] to change the Operation Mode, or press [N/+] to skip it.

If you press [Y/+], you see the Operation Mode (OP Mode) screen:

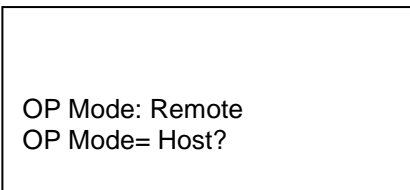

Press [N/-] to step through these options:

- Host
- Remote
- Repeater

RAELink3 User's Guide

Once you have made your selection, press [Y/+] to save the change.

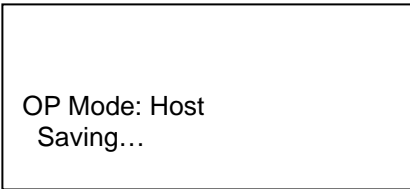

After the change is saved, the display returns to the beginning screen for Operation Mode (your choice of Operation Mode is shown):

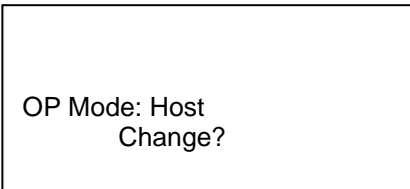

Press [Y/+] if you want to change the Operation Mode, or press [N/+] to advance to the GPS Power Control screen.

12.3.1 Remote Mode's Bluetooth And Cable Sub-Modes

When it is in Remote Mode, the RAELink3 allows settings for Bluetooth and Cable connection with a RAE Systems monitor or some third-party monitors such as the ProEngin AP4C and TSI DustTrak2. Remote, Bluetooth, and Cable are organized as follows:

Remote Mode

Bluetooth

- Bypass
- GammaRAE 2
- BioHarness

Cable

- Bypass
- RAE PTP
- AP4C
- ChemRAE
- DustTrak2

RAELink3 User's Guide

When connecting a Remote device, you must choose the appropriate setting for the connection type as listed below. For example, when connecting a ChemRAE, you must choose “ChemRAE” under the “Cable” menu.

Use this chart to guide you in choosing the correct setting:

Product	Connection	Setting
AP4C	Cable	AP4C
BioHarness	Bluetooth	BioHarness
ChemRAE	Cable	ChemRAE
DustTrak2	Cable	DustTrak2
GammaRAE II R	Bluetooth	GammaRAE2
MiniRAE 2000	Cable	Bypass
MiniRAE 3000	Bluetooth	Bypass
MultiRAE Plus	Cable	Bypass
ppbRAE Plus	Cable	Bypass
ppbRAE 3000	Bluetooth	Bypass
QRAE Plus	Cable	RAE PTP
UltraRAE 3000	Bluetooth	Bypass

Here are simplified connection rules:

- 3000 Series PIDs, GammaRAE II R, and BioHarness use Bluetooth (BT)
- All other products use Cable.
- If the name of the product is not listed in the submenu, then you must use Bypass.

Note: The only exception is the QRAE Plus, which requires Cable = RAE PTP.

RAELink3 User's Guide

When Remote Mode is selected, this screen is shown:

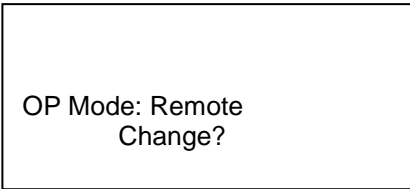

Press [N/-] to keep the RAELink3 in Remote Mode and to advance to the BT menu. The screen looks like this:

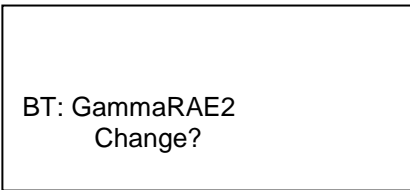

- Press [Y/+] if you want to change to another Bluetooth device in the list.
- Press [N/-] if you want to simply advance to Cable settings.

If you chose to change the BT setting, then you can use the [Y/+] and [N/-] buttons to navigate through the list and make a selection.

Cable Setting

If a cable is used to connect a monitor to a RAELink3 in Remote Mode, you must make sure the correct setting is selected for proper operation.

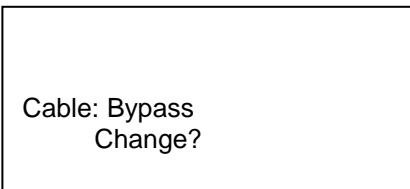

- Press [Y/+] if you want to change to another Cable setting in the list.
- Press [N/-] if you want to simply advance to GPS Status.

RAELink3 User's Guide

12.3.2 Simultaneous BT And Cable Operation

You can use a single RAELink3 in Remote Mode to transmit data from a Bluetooth-enabled and a cable-connected device simultaneously.

Here is a table showing supported RAE Systems and third-party devices, arranged by Cable or Bluetooth connection:

Cable	Bluetooth
QRAE Plus	MiniRAE3000
MultiRAE Plus	ppbRAE3000
MiniRAE2000	UltraRAE3000
ppbRAE Plus	GammaRAEII R
ChemRAE	BioHarness
DustTrakII	
AP4C	

To connect two devices simultaneously, make sure of the following:

- Each device must have a unique Unit ID.
- The correct device must be selected in the BT and Cable menus.

Example: To connect a MultiRAE Plus and a BioHarness to the same RAELink3, in Remote settings, select “Cable: Bypass.” Then select “BT: BioHarness.”

Note: If one of the two channels (Cable or Bluetooth) is not connected to a device, it is not necessary to select a setting for the unused channel.

RAELink3 User's Guide

Here is an example of the connections that should be made when multiple devices are used with each RAELink3:

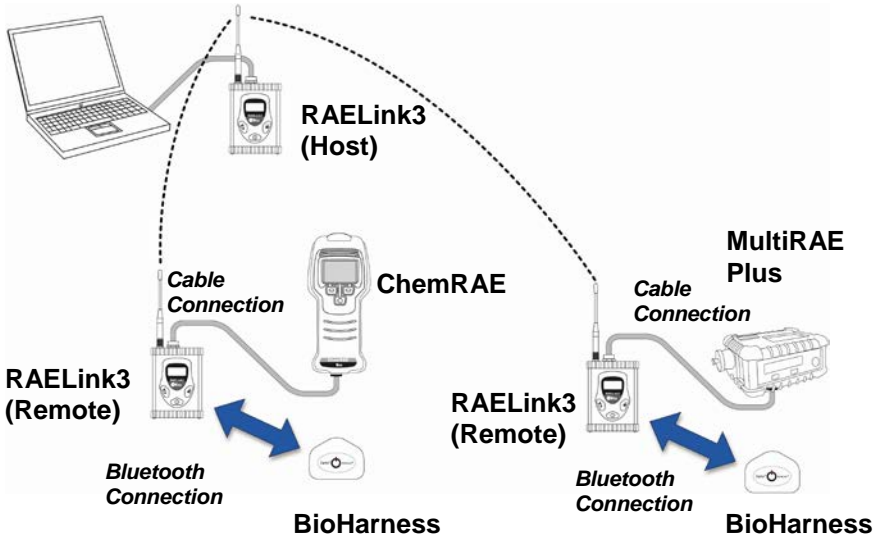

Note: If neither BT nor Cable is set to Bypass, then the BT-connected device is assigned the Unit ID as programmed into the RAELink3 (as outlined in section 12.7) and the Cable-connected device is assigned Unit ID +1. (Example: first Unit ID = 1 and second Unit ID = 2, or first Unit ID = 6 and second Unit ID = 7.)

RAELink3 User's Guide

Here is an example of how the Unit IDs can be set automatically but cause conflict. Note that the Unit ID set for the RAELink3 in Remote Mode determines the number set for its attached monitors:

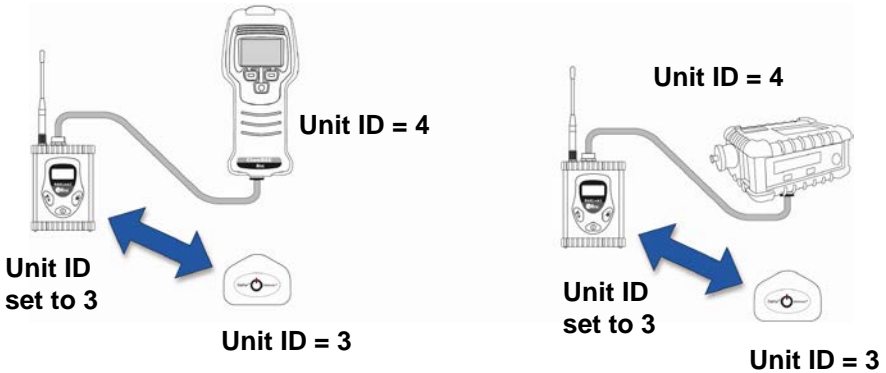

As you can see in this example network, there is duplication of Unit ID numbers. Therefore, you must manually set the unit ID in the RAELink3. This makes it especially important to set up RAELink3 connections sequentially, and then to check all RAELink3 connections after the first one to ensure that there are no Unit ID conflicts. They must all operate on the same Network ID, but each unit must have a unique Unit ID.

When you add systems using a RAELink3 Remote and BT or Cable connections to a network, you must be extra-careful to keep all Unit IDs unique. Make sure that the second (and any subsequent) RL3 Remote/monitor setups' Unit IDs do not match the Unit IDs from any other RL3 Remote/monitor setups.

RAELink3 User's Guide

Make sure the Unit IDs are not duplicated:

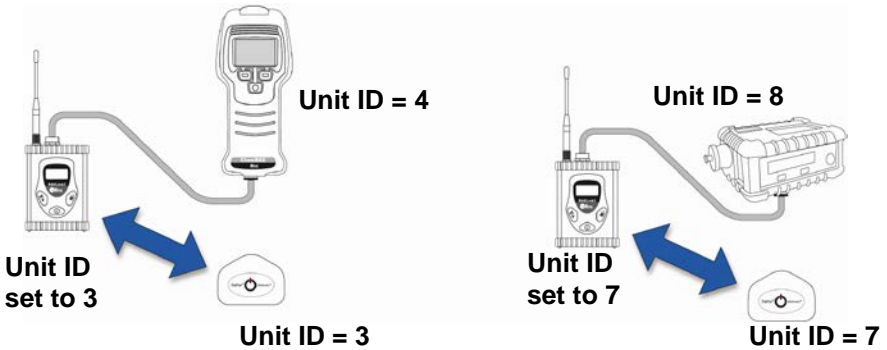

If you need to manually set Unit IDs for some monitors, see page 33 for details.

12.4 GPS Power Control

The onboard GPS can be turned on or off. The GPS Power Control screen is shown here:



Press [Y/+] to change the power status, or press [N/-] to skip to next menu screen, GPS Coordinates Output.

RAELink3 User's Guide

If you change the power status of the onboard GPS, there is no confirmation screen. However, the status is updated immediately:

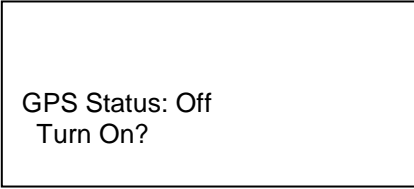

GPS Status: Off
Turn On?

When you are satisfied with the GPS status, you can advance to the next menu screen, GPS Coordinates Check, by pressing [N/-].

12.5 GPS Coordinates Check

Check the RAELink3's GPS location in this menu screen. If you want to have the coordinates checked and shown in the display, press [Y/+]. If not, press [N/-] to skip to the next menu screen.

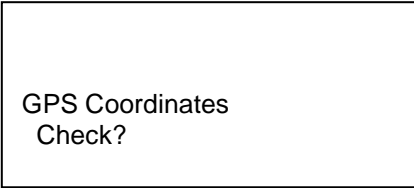

GPS Coordinates
Check?

If you press [Y/+], the GPS coordinates are displayed as shown (the 0's are replaced by degrees, minutes, and seconds):

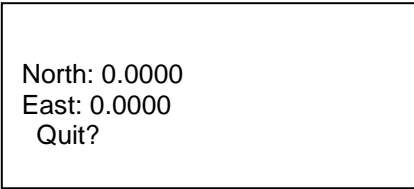

North: 0.0000
East: 0.0000
Quit?

RAELink3 User's Guide

Press [Y/+] to quit. (Pressing [N/-] or [MODE] does not change the screen.) The first screen of GPS Coordinates Check is shown:

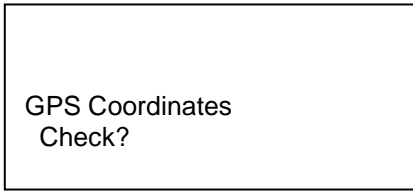

Press [N/-] to advance to the next screen, Bluetooth Power Control.

12.6 Bluetooth Power Control

The onboard Bluetooth connection can be turned on or off. The Bluetooth Power Control screen is shown here:

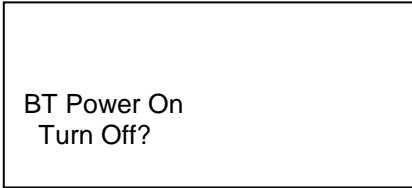

Press [Y/+] to change the on/off status, or press [N/-] to skip to next menu screen, Set Unit ID.

If you press [Y/+] and change the on/off status, the status is toggled and the screen displays the change:

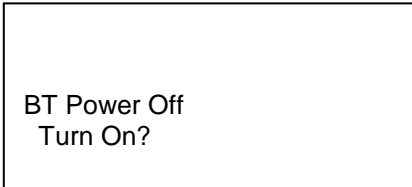

When you are satisfied with the Bluetooth status, you can advance to the next menu screen, Set Unit ID, by pressing [N/-].

12.7 Setting The Unit ID

Each Remote Unit in an AreaRAE network must be assigned a unique Unit ID (between 00 and 99). Make sure that the unit ID is not duplicated among any of the Remote units within the same AreaRAE network.

Note: Sometimes the Unit ID is set on the remote monitor (for example, on a MiniRAE3000 or MultiRAE Plus), and sometimes it is set on the RAELink3 attached to a monitor (such as a GammaRAEII R).

RAELink3 User's Guide

Note: When RAELink3 is configured as a Repeater or Host, it does not require a Unit ID. Therefore, the Set Unit ID Menu is not applicable in this mode.

When RAELink3 is configured as a Remote, the Set Unit ID menu screen looks like this:

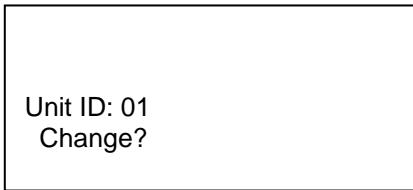

Press [Y/+] if you want to change the Unit ID. When changing the Unit ID, the cursor flashes on the selected digit, highlighting it and indicating that you can change it:

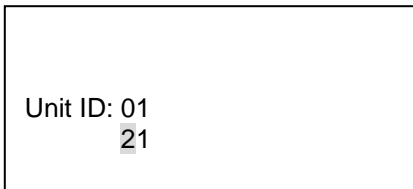

1. Press [Y/+] to increase the number or [N/-] to decrease the number.
2. Press [MODE] to advance to the next digit.
3. Input a Unit ID (00 through 64 for ProRAE Guardian).

To accept the new Unit ID, press and hold [MODE] for 2 seconds. A confirmation screen appears, as shown here:

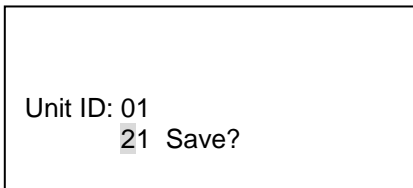

RAELink3 User's Guide

Press [Y/+] to save, or press [N/-] to abort the change.

If you save the Unit ID, you see this display as it saves:

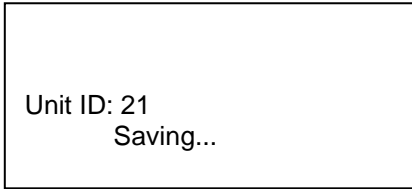

When it is done, the display returns to the Set Unit ID screen, showing the new Unit ID:

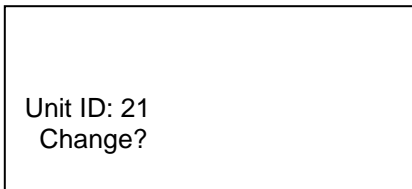

If you want to change the Unit ID, repeat the procedure.

This table shows where the Unit ID is set based on the monitor type:

Product	Unit ID
AP4C, BioHarness, ChemRAE, DustTrak2, GammaRAE II R, QRAE Plus	RAELink3
MiniRAE 2000, MiniRAE 3000, MultiRAE Plus, ppbRAE Plus, ppbRAE 3000, UltraRAE 3000	Monitor

To progress to the next screen, press [N/-]-Key.

12.8 Modem Configuration Menu

In this program mode, the onboard modem configuration menu can be output and accessed via PC using a HyperTerminal program.

IMPORTANT!

Do not enter and change any parameters in this menu unless directed to do so by authorized technical support personnel.

Note: The RAELink3 must be connected to a computer with a cable, and a HyperTerminal program must be running.

The Modem Configuration screen is shown here:

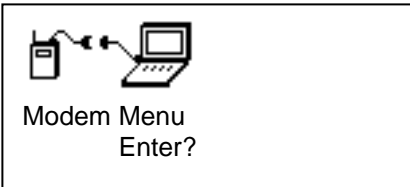

Press [Y/+] to output the modem menu to a PC, or press [N/-] to skip to the beginning of the programming menus

Alternatively, you can press [MODE] to exit Programming Mode.

13 Connecting A RAELink3 Remote Via Bluetooth

When you turn on a RAELink3 modem configured as a Remote, and its Bluetooth Power Control is set to “on,” the RAELink3 can communicate wirelessly with a portable gas monitor (such as a MiniRAE 3000, or ppbRAE 3000).

RAELink3 User's Guide

If you see this screen when you turn on the RAELink3 Remote, then you must turn on the Bluetooth. See page 33 for details that cover turning Bluetooth on and off.



When Bluetooth is on and a link to a Bluetooth device is established, you see this screen (otherwise, you see “No Record” or “BT Power Off”):



BT Linked: 596-000123

Note: If the RAELink3 is new and/or has never established a connection before, the display shows this message, indicating that no ID number has been previously stored:



BT No Record

The RAELink3 can scan for Bluetooth-enabled monitors, and stores up to 2 connections in memory for faster re-deployment.

Follow these steps to connect a RAELink3 to a monitor via Bluetooth:

1. Turn on the Bluetooth-enabled monitor. Make sure it is set up to run Bluetooth (Bluetooth is turned on).
2. Turn on the RAELink3. It should be in Remote Mode, and Bluetooth turned on.

Important! If you are re-pairing the RAELink3 with the primary Bluetooth detector in its memory (indicated by an

RAELink3 User's Guide

asterisk next to the serial number), Step 3 can be skipped.

3. Enter Programming Mode. Press and hold [MODE] and [N/-] for 3 seconds. This screen appears:



Start BT Search?

- (1) Null
- (2) Null

If you want to search for a Bluetooth-enabled monitor and have it paired with the RAELink3, press [Y/+]. It begins searching, and you see a screen like this:



BT Searching . . .

- (1) Null
- (2) Null

Note: If multiple monitors will be in your network, it is fastest to turn one monitor and one RAELink3 on at a time for this initial pairing.

When a successful pairing is made, the screen lists the monitor's ID number and gives this message in the display:



Done! Find Again?

- * (1) 596-000123
- (2) 596-000184

Note: The primary Bluetooth connection is indicated with an asterisk.

If you want the RAELink3 to search again, press [Y/+]. If you want to proceed to the next step in Programming Mode, press [N/-]. To exit to the main screen, press [MODE].

RAELink3 User's Guide

Note: Upon powering on, the RAELink3 automatically searches for the primary Bluetooth device indicated by the asterisk in memory.

4. The two units connect and exchange ID numbers. The ID number of the monitor is shown below the icons.



5. They are now connected.

14 Connecting A RAELink3 Remote Via Cable

Connect a portable gas monitor (PGM) such as a ppbRAE Plus, MiniRAE 2000, or MultiRAE Plus to the RAELink3 configured as a Remote using the optional Portable Coiled Cable (part number 400-0189-000).

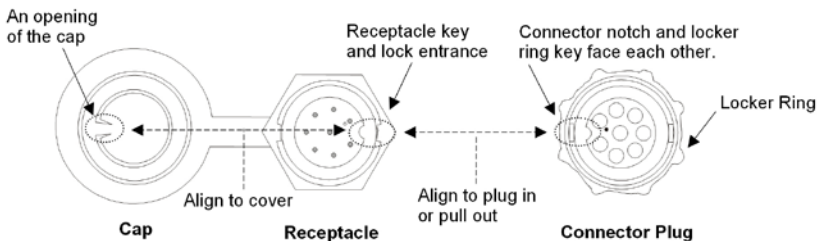

- Connect the serial cable's 4-pin circular connector to the monitor. (Third-party sensor or detector units require a cable that comes with the specifically configured RAELink3.)
- Connect the other end to the RAELink3.

Note: The cable connector that fits the RAELink3's multi-function receptacle has a locking ring. Align the cable's connector plug with the RAELink3's receptacle using the key and notch as a guide. Press

RAELink3 User's Guide

the connector into place, and then turn the connector's locking ring to tighten the connection. Never force the connector in or out of the receptacle.

14.1 GPS And Unobstructed Line Of Sight

GPS receivers operate by line of sight with global positioning satellites. A receiver must be able to get signals from at least three satellites in order to calculate longitude and latitude (there are currently 30 GPS satellites orbiting the earth). The more satellites a GPS receiver can "see," the more accurate and reliable the positioning.

For a GPS-equipped RAELink3 (or any other GPS device) to work properly, it must have a direct line of sight to a satellite, meaning it will not work well (if at all) indoors. Although radio signals from navigation satellites can pass through clouds, glass, plastic and other lightweight materials, satellite navigation receivers do not work underground or in other enclosed spaces.

If you need to operate a monitor under a roof or anything else that obstructs a clear view of the sky, you may need to take the RAELink3 outdoors into a nearby clear area, perform a manual GPS Coordinates Check (see page 31), and then either allow those coordinates to be used on maps in ProRAE Guardian running on a host computer, or input them manually.

14.2 Cleaning The RAELink3

Occasional cleaning with a soft cloth is recommended. Do not use detergents or chemicals.

Visually inspect the contacts on the rear of the RAELink3, on the battery, and on the Charging Cradle to make sure they are clean. If they are not, wipe them with a soft, dry cloth. Never use solvents, abrasives, or cleaners.

14.3 Ordering Replacement Parts

In the U.S., you can order sensors, replacement batteries, and other accessories online at:

<http://istore.raesystems.com/>

14.4 Special Servicing Note

If the instrument needs to be serviced, contact:

The RAE Systems Technical Service Department. Before returning the instrument for service or repair, obtain a Returned Material Authorization (RMA) number for proper tracking of your equipment. This number needs to be on all documentation and posted on the outside of the box in which the instrument is returned for service or upgrade. Packages without RMA Numbers will be refused at the factory.

15 Troubleshooting

Problem	Possible Reasons & Solutions
Cannot turn on power after charging the battery	Charge or replace battery.
Remote unit not communicating with Host Controller	<p>Confirm RAELink3 is in Remote Mode</p> <p>Check the Network ID</p> <p>Check battery charge on the Remote unit</p> <p>Make sure you have a unique Unit ID on each RAELink3 or device connected to a RAELink3.</p> <p>Check the cable or Bluetooth connection between the RAELink3 and the remote device</p>
Device does not link with RAELink3 via Bluetooth.	<p>Make sure device's Bluetooth is turned on.</p> <p>Make sure the RAELink3 is in Bluetooth search mode.</p> <p>If this is the first time connecting, allow time to link.</p>
RAELink3 is not picking up satellites to load a map in ProRAE Guardian.	<p>Make sure GPS is turned on.</p> <p>Make sure the RAELink3 has unobstructed view of the sky.</p>

16 Technical Support

To contact RAE Systems Technical Support Team:

Monday through Friday, 7:00AM to 5:00PM Pacific (US) Time

Phone (toll-free): +1 888-723-4800

Phone: +1 408-952-8461

Email: tech@raesystems.com

17 RAE Systems Contacts

RAE Systems by Honeywell

World Headquarters

3775 N. First St.

San Jose, CA 95134-1708 USA

Phone: +1 408.952.8200

Fax: +1 408.952.8480

E-mail: customerserv@raesystems.com

Web Site: www.raesystems.com

RAE Systems Technical Support

Monday through Friday, 7:00 AM to 5:00 PM Pacific Time

Phone: +1.408.952.8461

Email: tech@raesystems.com

RAE Systems Europe ApS

Kirstinehøj 23 A

DK-2770 Kastrup

Denmark

Phone: +45 86 52 51 55

Fax: +45 86 52 51 77

orders@raeeurope.com

sales@raeeurope.com

Web: www.raesystems.eu

RAELink3 User's Guide

RAE Systems UK Ltd

D5 Culham Innovation Centre
Culham Science Centre
Abingdon, Oxon OX14 3DB
United Kingdom

Phone: +44 1865408368

Fax: +44 1235531119

Mobile: +44 7841362693

Email: raeuk@raeeurope.com

RAE Systems France

336, rue de la fée des eaux
69390 Vernaison
France

Phone: +33 4 78 46 16 65

Fax: +33 4 78 46 25 98

Email: info-france@raeeurope.com

Web: www.raesystems.fr

RAE BeNeLux BV

Hoofdweg 34C
2908 LC Capelle a/d IJssel
The Netherlands

Phone: +31 10 4426149

Fax: +31 10 4426148

Email: info@rae.nl

Web: www.rae.nl

RAE Systems Spain, s.l.

Av. Remolar, 31
08820 El Prat de Llobregat
Spain

Phone: +34 933 788 352

Fax: +34 933 788 353

Mobile: +34 687 491 106

Email: mdelgado@raespain.com

Web: www.raespain.com

RAELink3 User's Guide

RAE Systems Middle East

LOB 7, Ground Floor, Office 19,
Jebel Ali Free Zone
Dubai, United Arab Emirates

Phone: +971.4.887.5562

Email: mesales@raesystems.com

RAE Systems (Hong Kong) Ltd.

Room 8, 6/F, Hong Leong Plaza
33 Lok Yip Road
Fanling, N.T, Hong Kong

Phone: +852.2669.0828

Fax: +852.2669.0803

Email: hksales@raesystems.com

RAE Systems Japan

403 Plaza Ochanomizu Bldg. 2-1
Surugadai Kanda Chiyoda-Ku
Tokyo, Japan

Phone: 81-3-5283-3268

Fax: 81-3-5283-3275

Email: jpsales@raesystems.com

RAE Systems Korea

#1010, DaeMyungAnsVill First,
Sang-Dong 412-2, Wonmi-Gu, Bucheon,
Kyungki-Do, Korea

Phone: 82-32-328-7123

Fax: 82-32-328-7127

Email: krsales@raesystems.com



**RAE Systems by Honeywell
World Headquarters**

3775 N. First St.
San Jose, CA 95134-1708 USA
Phone: 408.952.8200
Toll-Free: 888.723.4800
Fax: 408.952.8480

E-mail (sales support): raesales@raesystems.com
Web Site: www.raesystems.com

Technical Support

Phone: 408.952.8461 (Mon-Fri, 7AM-5PM, PST)
Email: tech@raesystems.com

Training

Courses: www.raesystems.com/support
Email: training@raesystems.com

Product Registration

www.raesystems.com/support/product-registration

RAE Systems Europe

Kirstinehøj 23A, DK-2770 Kastrup • Denmark
Phone: +45.8652.5155 • **Fax:** +45.8652.5177
Web: www.raesystems.eu • **Email:** sales@raeeurope.com

RAE Systems (Hong Kong) Ltd.

Units 1516-18, 15/F, Delta House, 3 On Yiu Street
Shatin, N.T. Hong Kong
Phone: +852.2669.0828 • **Fax:** +852.2669.0803
Web: www.raesystems.com.hk
Email: service@raesystems.com.hk

RAE Systems Middle East

LOB 7, Ground Floor, Office 19, Jebel Ali Free Zone
Dubai, United Arab Emirates
Email: mesales@raesystems.com • **Phone:** +971.4.887.5562

Rev. B
August 2011
P/N 029-4508-000