

## SMB SYSTEM S

1,3 kg

EN 13374-A

Item	Part number
1	11084
2	100401, ISO 4014 - M10 x 80
3	100027, ISO 7040 - M10

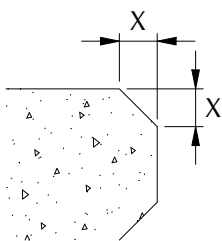
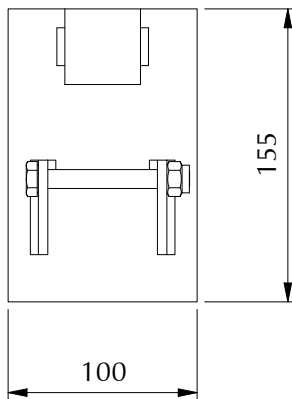

$X \leq 10 \rightarrow$

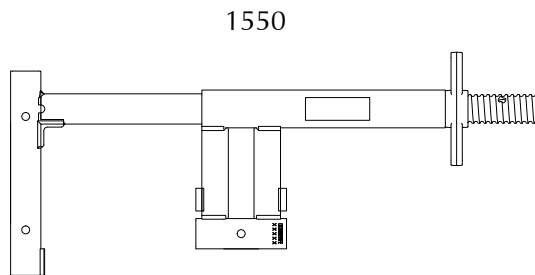

$10 < X \leq 40 \rightarrow$

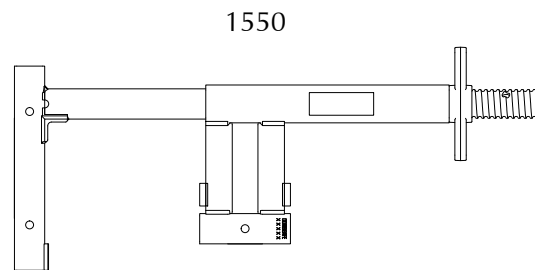

11085

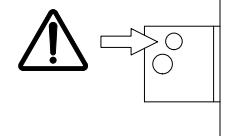
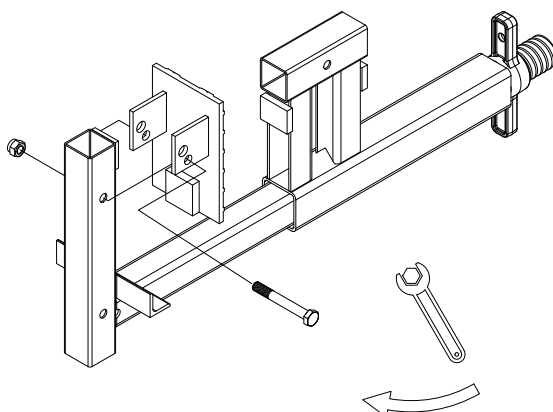

1.

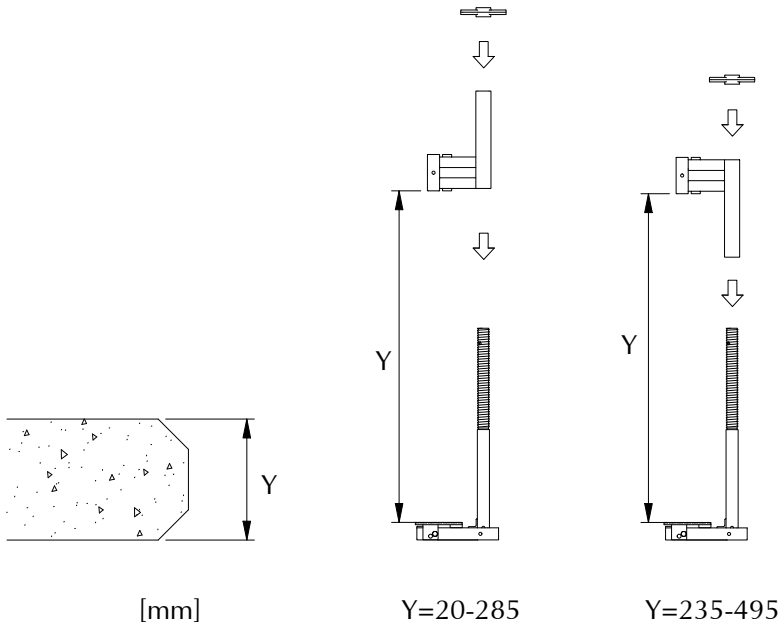

2.

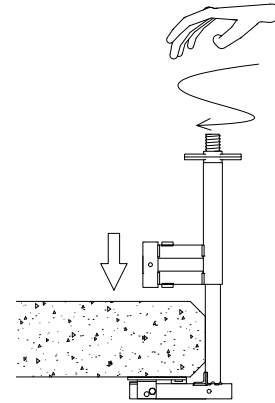

3.

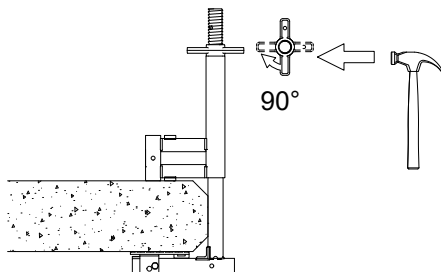

4.

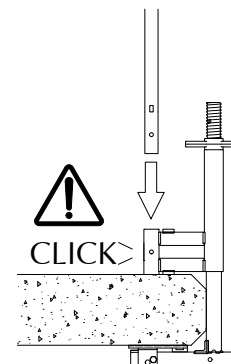

**NB!**

