

MicroDock II

Automatic Test and Calibration Station

User Manual

BWF
Technologies
by Honeywell

Limited Warranty and Limitation Liability

BW Technologies LP (BW) warrants the product to be free from defects in material and workmanship under normal use and service for a period of two years, beginning on the date of shipment to the buyer. This warranty extends only to the sale of new and unused products to the original buyer. BW's warranty obligation is limited, at BW's option, to refund of the purchase price, repair or replacement of a defective product that is returned to a BW authorized service center within the warranty period. In no event shall BW's liability hereunder exceed the purchase price actually paid by the buyer for the Product.

This warranty does not include:

- a) fuses, disposable batteries or the routine replacement of parts due to the normal wear and tear of the product arising from use;
- b) any product which in BW's opinion, has been misused, altered, neglected or damaged, by accident or abnormal conditions of operation, handling or use;
- c) any damage or defects attributable to repair of the product by any person other than an authorized dealer, or the installation of unapproved parts on the product; or

The obligations set forth in this warranty are conditional on:

- a) proper storage, installation, calibration, use, maintenance and compliance with the product manual instructions and any other applicable recommendations of BW;
- b) the buyer promptly notifying BW of any defect and, if required, promptly making the product available for correction. No goods shall be returned to BW until receipt by the buyer of shipping instructions from BW; and
- c) the right of BW to require that the buyer provide proof of purchase such as the original invoice, bill of sale or packing slip to establish that the product is within the warranty period.

THE BUYER AGREES THAT THIS WARRANTY IS THE BUYER'S SOLE AND EXCLUSIVE REMEDY AND IS IN LIEU OF ALL OTHER WARRANTIES, EXPRESS OR IMPLIED, INCLUDING BUT NOT LIMITED TO ANY IMPLIED WARRANTY OF MERCHANTABILITY OR FITNESS FOR A PARTICULAR PURPOSE. BW SHALL NOT BE LIABLE FOR ANY SPECIAL, INDIRECT, INCIDENTAL, OR BASED ON CONTRACT, TORT OR RELIANCE OR ANY OTHER THEORY.

Since some countries or states do not allow limitation of the term of an implied warranty, or exclusion or limitation of incidental or consequential damages, the limitations and exclusions of this warranty may not apply to every buyer. If any provision of this warranty is held invalid or unenforceable by a court of competent jurisdiction, such holding will not affect the validity or enforceability of any other provision.

BW Technologies by Honeywell
Corporate Headquarters
Suite 110 4411-6 Street SE
Calgary, AB
Canada T2G 4E8

BW Technologies by Honeywell
America
405 Barclay Blvd.
Lincolnshire, IL
USA 60069

BW Technologies by Honeywell
Europe
Javastrasse 2
8604 Hegnau
Switzerland

Email us at: Bwa.customerservice@honeywell.com

Visit BW Technologies by Honeywell's website at: www.honeywellanalytics.com

Table of Contents

Table	Page
Introduction	1
Contacting BW Technologies by Honeywell	2
Safety Information - Read First	2
Getting Started	5
MicroDock II Base Station and Docking Modules	6
Parts of the MicroDock II Base Station and Docking Module	7
Display Elements	8
Pushbuttons	8
Docking Module Pushbuttons	8
Base Station Pushbuttons	9
Installation	10
Battery Installation	11
Inserting the GasAlertClip Extreme and the GasAlert Extreme	12
Inserting the GasAlertMicro	14
Inserting the GasAlertMicro 5/PID/IR.....	16
Inserting the GasAlertMicro 5/PID/IR Battery Pack	18
Inserting the GasAlertMicroClip / GasAlertMicroClip XT	20
Inserting the GasAlertMax XT / GasAlertMax XT II	22
Inserting the GasAlertQuattro	24
Inserting the GasAlertQuattro Battery Pack	25
Adding Another Docking Module	27
Initializing the New Docking Module	31
Defining Pump Speed	31

Title	Page
Mounting the MicroDock II	32
Changing Dip Switch Settings (<i>GasAlertClip Extreme only</i>)	34
Using the Base Station	37
Confirming Inlet Setup	37
Activating the Base Station	37
Self-Test	37
Deactivating the Base Station	38
User Options Menu	39
Time/Date	39
Inlet Setup	40
Gas Type	41
Gas Concentration Level	43
Gas Cylinder Lot # Field	44
Pump Setup	45
Contrast	45
Backlight	46
About	46
Formatting the MMC/SD Card	47
Inlet Select	48
Pass Code	49
Entering User Options When Pass Code Protected	50
Language	50
Results History	51
Reconfiguring the Detector (<i>not applicable to the GasAlertClip Extreme</i>)	52
Gas Conflicts	54
Abort Option	55
Conflicts	55

Title	Page
Base Station Selects the Gas Inlet	56
User Selects Gas Inlet	56
Not Found	57
Accessing the MMC/SD Card During a Test	58
Order of Gases Applied for Bump Tests and Calibrations.....	59
Bump Test.....	62
Bump Test Results.....	65
Bump Pass	65
Bump Fail.....	65
Incorrect Inlet Setup.....	66
Sensor Disabled.....	66
Calibration	67
Guidelines	67
Calibration Procedure (<i>All models excluding the GasAlertClip Extreme</i>)	68
GasAlertMicro 5 IR with CO ₂ Sensor.....	69
Calibration Results.....	70
Calibration Pass.....	70
Calibration Fail.....	71
Incorrect Inlet Setup.....	71
Sensor Disabled.....	71
Data Transfer	72
Transferring Datalogs	72
Maximum Datalog Storage Capacity	73
Automatic Datalog Download.....	73
Using the IR Link.....	73
Using the MicroDock II.....	73
Base Station MMC/SD Card.....	75

Title	Page
Event Logging	75
Inserting/Replacing a MMC/SD Card	76
Accessing Test Results	76
System requirements	76
Charging the Detector	77
Charger/Battery Pack Guidelines	77
Charging Different Detectors Together	78
Charging Procedure	78
Maintenance	79
Battery Pack Storage	79
GasAlertMicro and GasAlertMicro 5/PID/IR	79
GasAlertMicroClip / GasAlertMicroClip XT	79
Troubleshooting	80
Replacement Parts and Accessories	87
Specifications	88
Charger Specifications	89

List of Tables

Title	Figure	Page
1.	International Symbols	4
2.	The MicroDock II Base Station and Docking Module	7
3.	Display Elements	8
4.	Docking Module Pushbuttons.....	8
5.	Base Station Pushbuttons	9
6.	Base Station Connections	10
7.	Inserting the GasAlertClip Extreme and the GasAlert Extreme.....	12
8.	Inserting the GasAlertMicro	14
9.	Inserting the GasAlertMicro 5/PID/IR	17
10.	Inserting the GasAlertMicroClip / GasAlertMicroClip XT	20
11.	Inserting the GasAlertMax XT / GasAlertMax XT II	22
12.	Inserting the GasAlertQuattro.....	24
13.	Torque Specifications.....	27
14.	Adding Another Docking Module.....	27
15.	Mounting the MicroDock II.....	33
16.	Dip Switch Settings.....	34
17.	Changing Dip Switch Settings	34
18.	Inlets 2-5 – Available Gas Types.....	41
19.	Gas Type Application Table	60
20.	Gas Application Rules	61
21.	Charger Status LED	78
22.	Troubleshooting Tips	80
23.	Replacement Parts and Accessories.....	87

List of Figures

Figure	Title	Page
1.	MicroDock II Base Station and Docking Modules.....	6
2.	The MicroDock II Base Station and Docking Module	7
3.	Base Station Pushbuttons	9
4.	Base Station Connections	10
5.	Inserting the GasAlertClip Extreme and the GasAlert Extreme.....	12
6.	Inserting the GasAlertMicro	14
7.	Inserting the GasAlertMicro 5/PID/IR	16
8.	Removing the Diffusion Adapter.....	17
9.	Removing the Micro 5/PID/IR Lithium Battery Pack.....	18
10.	Inserting the GasAlertMicroClip / GasAlertMicroClip XT	20
11.	Inserting the GasAlertMax XT / GasAlertMax XT II.....	22
12.	Aligning the Arrows on the GasAlertMax XT / GasAlertMax XT II Docking Module	23
13.	Inserting the GasAlertQuattro.....	24
14.	Removing the GasAlertQuattro Battery Pack.....	25
15.	Adding Another Docking Module (Front View)	28
16.	Adding Another Docking Module (Back View).....	29
17.	Attaching Back Cover Plate (Back View).....	30
18.	Attaching the Wall Mounting Plate.....	32
19.	Parts of the Wall Mounting Plate	33
20.	Detaching the GasAlertClip Extreme Module.....	35
21.	Changing Dip Switch Settings	36
22.	Inserting the MMC/SD Card into the Base Station	47
23.	Load Configuration File Dialog Box.....	73

Figure	Title	Page
24.	Save Configuration Dialog Box.....	74
25.	Save to MicroDock(s) Dialog Box.....	74
26.	Replacing a MMC/SD Card	76

MicroDock II

Introduction

Warning

To ensure personal safety, read the [Safety Information](#) before using the MicroDock II Base Station.

The MicroDock II Automatic Test and Calibration Station (“the base station”) provides automated calibration and bump testing for

- GasAlertClip Extreme,
- GasAlert Extreme,
- GasAlertMicro,
- GasAlertMicro 5,
- GasAlertMicro 5 PID,
- GasAlertMicro 5 IR,
- GasAlertMicroClip / GasAlertMicroClip XT,
- GasAlertMax XT / GasAlertMax XT, and
- GasAlertQuattro detectors.

The base station also provides data transfer for

- GasAlert Extreme,
- GasAlertMicroClip / GasAlertMicroClip XT,
- GasAlertMax XT / GasAlertMax XT II, and
- GasAlertQuattro detectors.

Note

A maximum of six docking modules can be connected to the base station (any combination of charging and non-charging modules).

Refer to [Charging the Detector](#).

Contacting BW Technologies by Honeywell

To contact BW Technologies by Honeywell, call:

Canada & USA: 1-888-749-8878

Europe: 00800-333-222-44

Other countries: 1-403-248-9226

Address correspondence to:

BW Technologies by Honeywell

Suite 110 4411-6 Street SE

Calgary, Alberta

Canada, T2G 4E8

Email us at: Bwa.customerservice@honeywell.com

Visit BW Technologies by Honeywell's website at:

www.honeywellanalytics.com

ISO 9001

Safety Information - Read First

Use the base station only as specified in this manual.

International symbols on the base station and in this manual are explained in Table 1.

Read the Caution statements on the following pages before using the base station.



This instrument contains batteries. Do not mix with the solid waste stream. Spent batteries should be disposed of by a qualified recycler or hazardous materials handler.

⚠ Cautions

MicroDock II base station

- If the base station is damaged or parts are missing, contact [BW Technologies by Honeywell](#) immediately.
- The base station must be used only in a fresh air environment. Do not use the base station in a hazardous area. Failure to adhere to this caution can lead to fire and/or explosion.
- This equipment uses potentially harmful gas for calibrations. The base station must be attached to a venting system or be used in a well-ventilated area.
- Do not calibrate the detector during or immediately after charging is complete.
- Perform calibrations and bump tests only in a fresh air environment.
- The maximum recommended exhaust line length is 50 ft. (15.24 m).
- Ensure that the inlet filter is clean.
- Ensure that all gas cylinders contain enough gas.
- Ensure the exhaust line is not connected to a negative pressure system.
- A demand flow regulator must be used with all gas cylinder connections. Input pressure not to exceed 10 psi.
- Do not expose the base station to electrical shock or severe continuous mechanical shock.
- The base station warranty will be void if the unit is disassembled, adjusted, or serviced by non-BW Technologies by Honeywell personnel.
- Do not immerse the base station in liquids.
- Do not replace detachable MAINS supply cords with inadequately rated cords.
- The external AC/DC power adapter must be supplied with an approved cords suitable for end use installation.



GasAlertMicro, GasAlertMicro 5/PID/IR, GasAlertMicroClip / GasAlertMicroClip XT, GasAlertMax XT / GasAlertMax XT II, and GasAlertQuattro Chargers

- If the charger is damaged or parts are missing, contact [BW Technologies by Honeywell](#) immediately.

⚠ Cautions

- **Do not change or charge the batteries in a hazardous location. Do not use the charger in a hazardous location. Failure to adhere to these cautions can lead to fire and/or explosion.**
- **Read and adhere to all instructions and cautions that are provided with the charger. Failure to do so can result in fire, electric shock, personal injury, and/or property damage.**
- **Use only BW approved batteries; do not use alkaline or other rechargeable batteries with this charger.**
- **For indoor use only.**
- **Do not immerse the charger in liquids.**
- **Do not expose the charger to electrical shock or severe continuous mechanical shock.**
- **Ensure the detector battery pack is locked in place before operating the detector.**
- **To eliminate the risk of electrical shock, disconnect and deactivate the charger when cleaning or performing maintenance.**
- **Avoid touching the charger and detector contact pins.**
- **Substitution of components may impair Intrinsic Safety of the detector under charge.**
- **Do not charge the battery pack with any other charger.**
- **Do not attempt to disassemble, adjust, or service the charger unless instructions are provided to perform a procedure, or a part is listed as a replacement part in the user manual. Use only BW Technologies replacement parts. Refer to [Replacement Parts and Accessories](#).**
- **The charger warranty will be void if a customer, personnel, or third parties damage the charger during repair attempts. Any non-BW Technologies by Honeywell service/repair attempts will void this warranty.**
- **Products may contain materials that are regulated for transportation under domestic and international dangerous goods regulations. Return product in compliance with appropriate dangerous goods regulations. Contact freight carrier for further instructions.**

Table 1. International Symbols

Symbol	Description
	Approved to both U.S. and Canadian Standards by CSA International
	Conforms to European Union Directives

Getting Started

Confirm that the items listed below are included with the base station. If the base station is damaged or parts are missing, contact the place of purchase immediately.

- Batteries (four replaceable C-cell alkaline batteries)
- 128 MB Delkin MultiMediaCard (MMC) inserted
- USB cable
- Two to four calibration gas hoses (depending upon order at the time of purchase) with quick connect fittings
- Inlet filter assembly
- Power adapter
- Charger adapter (charger models only)
- CD: MicroDock II User Manual and MicroDock II Quick Reference Guide translations
- MicroDock II Quick Reference Guide

Note

A standard MicroDock II base station is shipped with two inlets. A maximum of four calibration gas inlets can be included if specified by the user before purchasing.

To order replacement parts, refer to [Replacement Parts and Accessories](#).

For information regarding the operations and functions of the base station, refer to the following figures and tables.

- [Figure 1. MicroDock II Base Station and Docking Modules](#)
- [Figure 2.](#) and [Table 2. The MicroDock II Base Station and Docking Module](#) (describes the base station)
- [Table 3. Display Elements](#) (describes the base station LCD icons)
- [Table 4. Docking Module Pushbuttons](#)
- [Figure 3.](#) and [Table 5. Base Station Pushbuttons](#)
- [Figure 4.](#) and [Table 6. Base Station Connections](#)

MicroDock II Base Station and Docking Modules

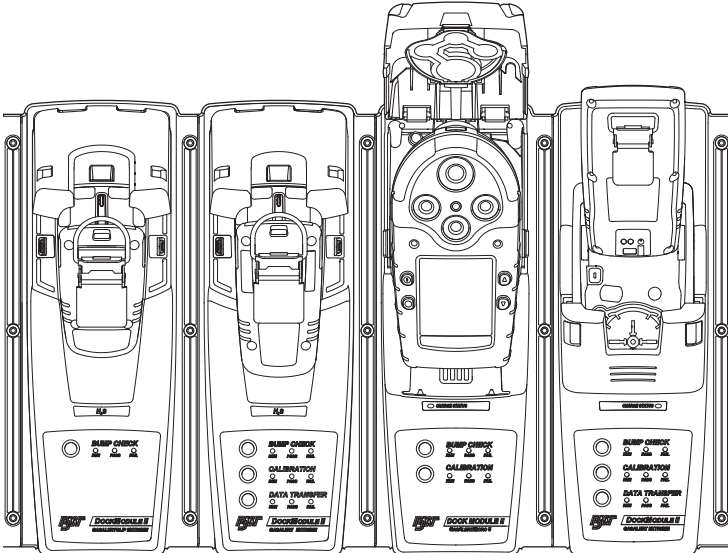

Parts of the MicroDock II Base Station and Docking Module

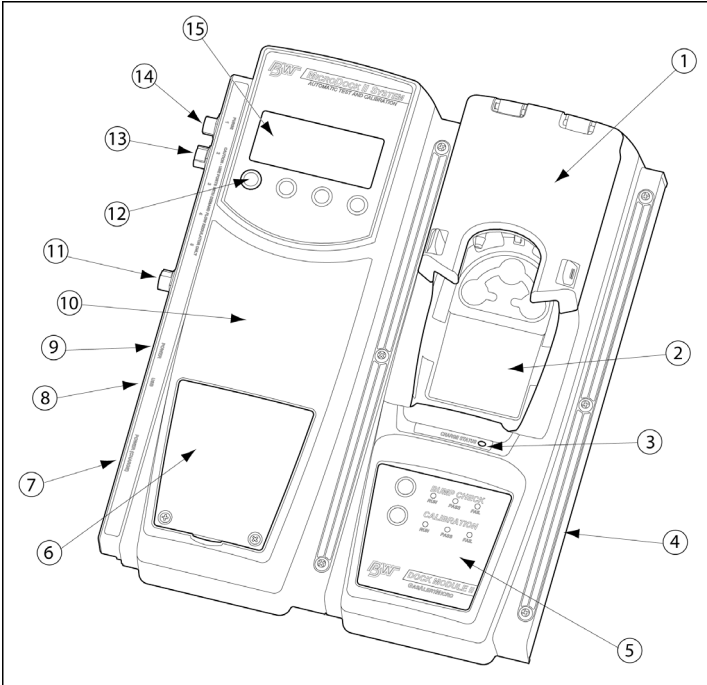

Figure 1. MicroDock II Base Station and Docking Modules

To connect additional docking modules and to correctly insert detectors into docking modules, refer to [Installation](#).

Note

The GasAlertMicroClip XT docking module is not pictured.

Figure 2. The MicroDock II Base Station and Docking Module

Table 2. The MicroDock II Base Station and Docking Module















Item	Description
1	Docking module lid
2	Detector bay
3	Charger status LED (optional)
4	Docking module
5	Docking module pushbuttons and status LEDs
6	Battery cover
7	Charger port (optional)
8	USB port
9	Power port
10	Base station
11	Exhaust outlet
12	Station pushbuttons
13	Calibration gas inlet (inlet 2)
14	Zero air/purge inlet (inlet 1)
15	Liquid crystal display (LCD)

⚠ Caution

Do not remove the battery cover while the base station is activated.

Display Elements

Table 3. Display Elements

Icon	Description
	AC power
	Batteries charged*
	Batteries half-charged*
	Batteries at low level*
	MMC or SD card
	MMC or SD card not inserted
	Test pass
	Test fail
	Cursor and sensor disabled
	Scroll up
	Scroll down
	Selection arrow
	Selected to be modified
	Pass code protected

* If powering the base station with batteries.

Pushbuttons

Docking Module Pushbuttons

Table 4. Docking Module Pushbuttons

Pushbutton	Description
<input type="radio"/> BUMP CHECK	To bump test a detector, press <input type="radio"/> BUMP CHECK . After connecting a new docking module, press and hold <input type="radio"/> BUMP CHECK to send a confirmation signal back to the base station.
<input type="radio"/> CALIBRATION	To calibrate a detector, press <input type="radio"/> CALIBRATION (all models excluding GasAlertClip Extreme).
<input type="radio"/> DATA TRANSFER	To transfer data from a detector, press <input type="radio"/> DATA TRANSFER . (GasAlert Extreme, GasAlertMicroClip / XT, GasAlertMax XT / II, and GasAlertQuattro only). The Automatic Datalog Download option is available for the GasAlertMicroClip / XT, GasAlertMax XT / II, and GasAlertQuattro docking modules only. For more information, refer to Automatic Datalog Download .

Base Station Pushbuttons

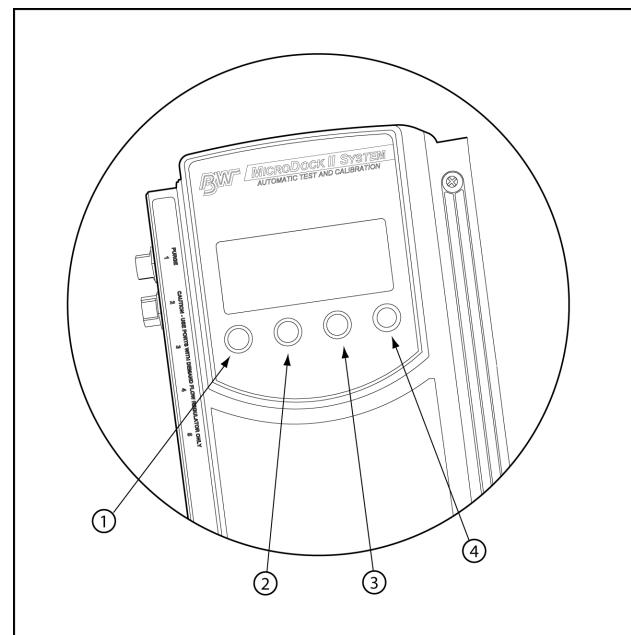

Figure 3. Base Station Pushbuttons

The base station pushbuttons activate, deactivate, scroll, select options, and perform functions.

Table 5. Base Station Pushbuttons

Item	Description
1	<ul style="list-style-type: none"> • Activate the base station • Select menu to access the user options • Select ↔ to scroll to different user options or to other functions/selections within a user option • Select OK
2	<ul style="list-style-type: none"> • Select log to view the results history log • Select sel to select an option • Access a modifiable field
3	<ul style="list-style-type: none"> • Select exit to exit from a modifiable option • Select exit from the user options menu to enter normal operation
4	<ul style="list-style-type: none"> • Deactivate the base station • Select ↕ to scroll to different user options or to other functions/selections within a user option

Installation

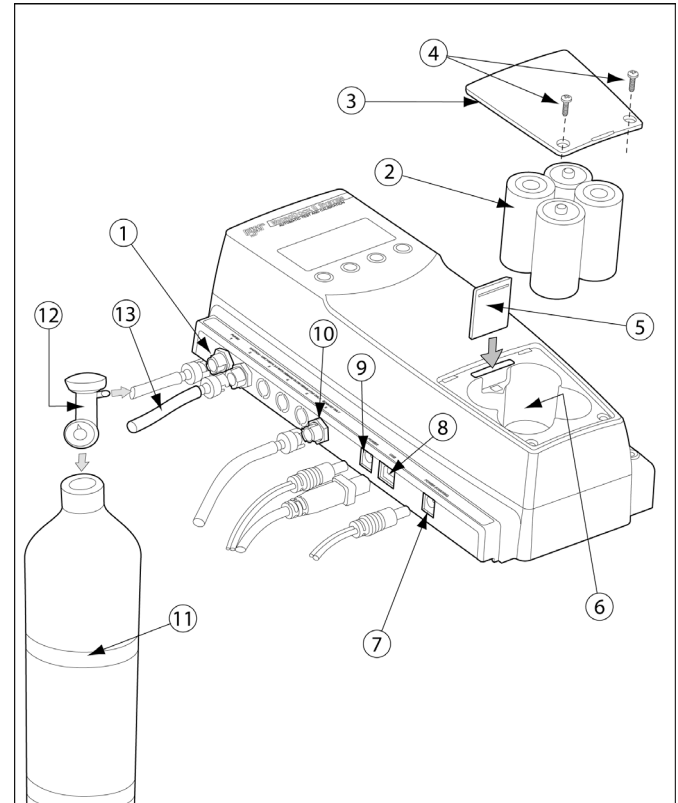

Figure 4. Base Station Connections

Table 6. Base Station Connections

Item	Description
1	Inlet filter assembly (PURGE 1)
2	C-cell batteries (4)
3	Battery cover
4	Phillips pan head retaining screws (2)
5	MMC or SD card
6	Battery compartment
7	Charger port
8	USB port
9	Power port
10	Exhaust outlet
11	Gas cylinder
12	Demand flow regulator
13	Calibration gas hose

⚠ Warning

Use the base station in a fresh air environment. Do not use the base station in a hazardous area.

Follow all required National Electrical Codes (NEC) and safety standards.

⚠ Caution

Do not remove the battery cover while the base station is activated.

Note

The base station can operate from either an electrical power source or batteries. The batteries will provide automatic backup power if the main power fails.

1. Connect the power cord to the POWER port on the base station and then plug the cord into an AC outlet.

To install the batteries, refer to [Battery Installation](#).

2. Connect the charger cord to the CHARGER port on the base station and then plug the cord into an AC outlet (if charging detectors with the docking modules).
3. Attach all gas connections. Inlet 1 (PURGE) is configured for ambient air and inlets 2-5 are configured for calibration/test gases. Refer to [Confirming Inlet Setup](#).

Note

If not using the base station in a fresh air environment, use a zero air gas cylinder for Inlet 1.

4. Connect the demand flow regulator. A demand flow regulator must be used with all gas cylinder connections.
5. Ensure the exhaust line is not connected to a negative pressure system.

For AC main operation, the method to disconnect power is to unplug the power cord from the outlet. A locking device may not be used on the power cord plug.

Battery Installation

⚠ Warning

Only change batteries in a fresh air environment. Do not charge the batteries in a hazardous area. Failure to adhere to this warning can result in personal injury and/or property damage. Use only Alkaline C-size batteries.

To install batteries in the base station, refer to [Figure 4](#), and complete the following:

1. Loosen the retaining screws from the battery cover. Do not remove the retaining screws from the battery cover.
2. Remove the battery cover.
3. Insert four C-cell batteries into the battery compartment.
4. Replace the battery cover and tighten the retaining screws. Do not over tighten the screws. Refer to [Table 13](#).

Inserting the GasAlertClip Extreme and the GasAlert Extreme

⚠ Caution

Infrared or intense ambient light (sun or halogen) may interfere with the base station/detector communication.

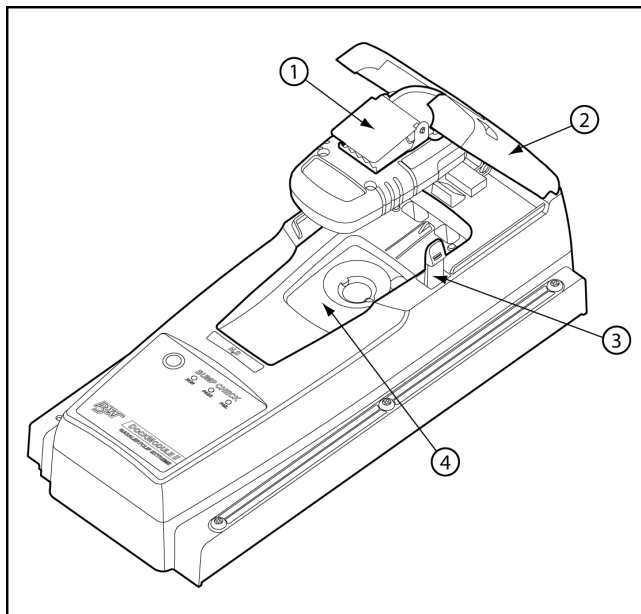

Figure 5. Inserting the GasAlertClip Extreme and the GasAlert Extreme

Table 7. Inserting the GasAlertClip Extreme and the GasAlert Extreme

Item	Description
1	Alligator clip
2	Docking module lid
3	Release tabs
4	Detector bay

Note

If the GasAlertClip Extreme or GasAlert Extreme is fitted with a calibration cap, it must be removed prior to inserting the detector into the docking module.

1. Activate the detector and wait until it is in normal operation.
2. Ensure the alligator clip is closed and the ring is resting flat to prevent disruptions with the data transmission.
3. Press the two release tabs on the docking module and raise the lid.
4. Lower the detector (serial number label up) into the detector bay. Push forward to ensure the top of the detector connects with the top of the bay.

5. Lower the lid and press down until the release tabs click.

When the detector has been inserted correctly, the RUN LED(s) on the docking module lights yellow and the base station LCD displays the

- the docking module number,
- **Unit Inserted**,
- detector type, and
- detector serial number.

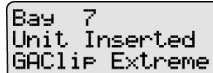

```
Bay 7
Unit Inserted
GAClip Extreme
```

Note

The serial number displays when a GasAlert Extreme is inserted.

6. To bypass the base station identification screen, press any  button on the base station.

Inserting the GasAlertMicro

⚠ Caution

Infrared or intense ambient light (sun or halogen) may interfere with the base station/detector communication.

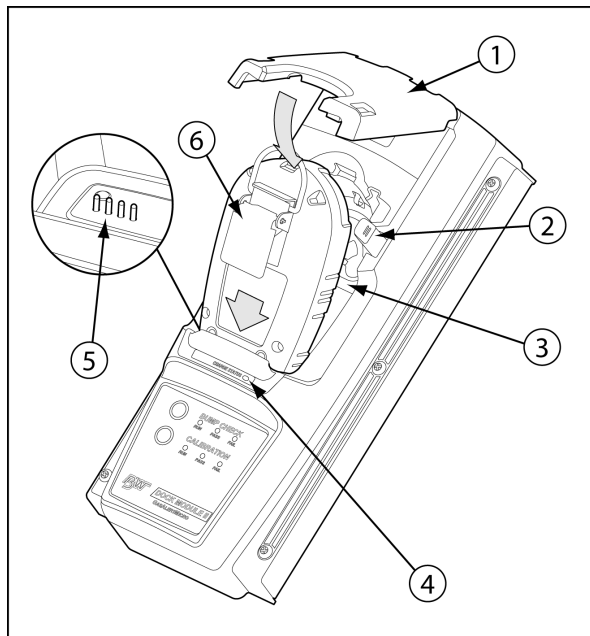

Figure 6. Inserting the GasAlertMicro

Table 8. Inserting the GasAlertMicro

Item	Description
1	Docking module lid
2	Release tabs
3	Detector bay
4	Charge status indicator (charging model only)
5	Connector pins (charging model only)
6	Alligator clip

Note

If the GasAlertMicro is fitted with a calibration cap, it must be removed prior to inserting the detector into the docking module.

7. Activate the detector and wait until it is in normal operation.
8. Ensure the alligator clip is closed and the ring is resting flat on the detector to prevent disruptions with data transmission.
9. Press the two release tabs on the docking module and raise the lid.
10. Insert the bottom of the detector into the detector bay (serial number label up) and then lower the top into place.

11. Lower the lid and press down until the release tabs click.

When the detector has been inserted correctly, the RUN LED(s) on the docking module lights yellow and the base station LCD displays the

- the docking module number,
- **Unit Inserted**,
- detector type, and
- detector serial number.



Bay 7
Unit Inserted
GasAlertMicro
4577587

12. To bypass the base station identification screen, press any  button on the base station.

Inserting the GasAlertMicro 5/PID/IR

Note

The GasAlertMicro 5, GasAlertMicro 5 PID, and GasAlertMicro 5 IR are referenced as the GasAlertMicro 5/PID/IR.

The GasAlertMicro 5/PID/IR rechargeable battery pack can be charged separately from the detector. Refer to [Inserting the GasAlertMicro 5/PID/IR Battery Pack](#).

⚠ Caution

Infrared or intense ambient light (sun or halogen) may interfere with the base station/detector communication.

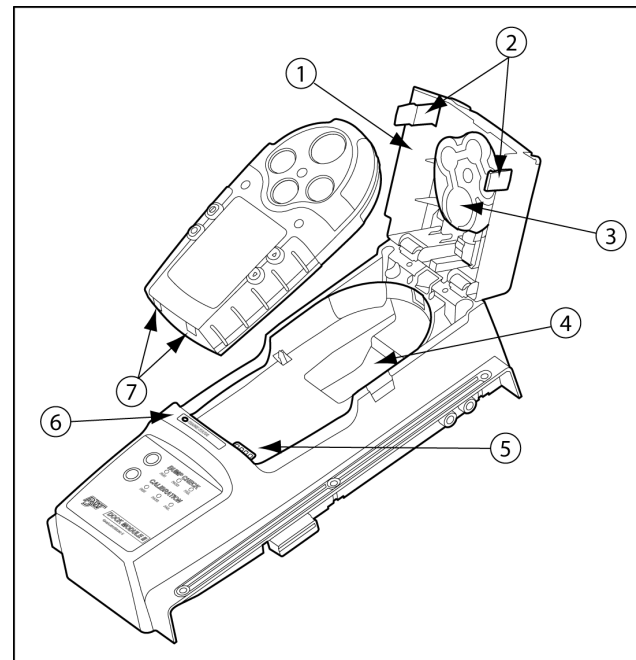

Figure 7. Inserting the GasAlertMicro 5/PID/IR

Note

Table 9 references Figure 7 and Figure 8.

Table 9. Inserting the GasAlertMicro 5/PID/IR

Item	Description
1	Docking module lid
2	Release tabs
3	Diffusion adapter
4	Detector bay
5	Connector pins (charging model only)
6	Charge status indicator (charging model only)
7	Connector outlets
8	Diffusion adapter release tab
9	Tool used to push down on diffusion adapter release tab

Note

If the GasAlertMicro 5/PID/IR is fitted with a calibration cap or pump auxiliary filter, it must be removed prior to inserting it into the docking module.

1. Activate the detector and wait until it is in normal operation.
2. Ensure the alligator clip is closed and the ring is resting flat on the detector to prevent disruptions with data transmission.

3. Press the two release tabs on the docking module and raise the lid.

Important: If the GasAlertMicro 5/PID/IR detector is fitted with a pump, the diffusion adapter must be removed from the docking module lid.

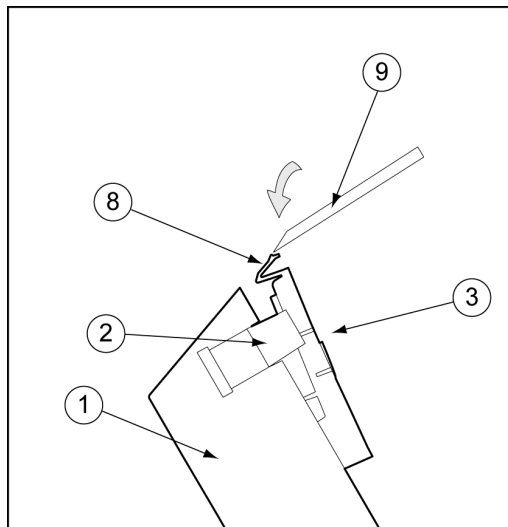

Figure 8. Removing the Diffusion Adapter

Using a small flathead screwdriver, press the release tab downwards. Pull the adapter forward slightly and then lift upwards to remove.

4. Hold the detector (serial number label down) at a 45° angle and insert the bottom into the detector bay.

Ensure that the connector outlets on the bottom of the detector lock into place over the connector pins in the docking bay, and then lower the top into place.

5. Lower the lid and press down until the release tabs click.

When the detector has been inserted correctly, the RUN LED(s) on the docking module lights yellow and the base station LCD displays the

- the docking module number,
- **Unit Inserted,**
- detector type, and
- detector serial number.

```
Bay 10
Unit Inserted
GasAlertMicro5
SE105-001075
```

The GasAlertMicro 5/PID/IR detector LCD displays **Microdock**.

6. To bypass the base station identification screen, press any  button on the base station.

Inserting the GasAlertMicro 5/PID/IR Battery Pack

To insert the lithium battery pack, refer to Figure 9. and the following procedure.

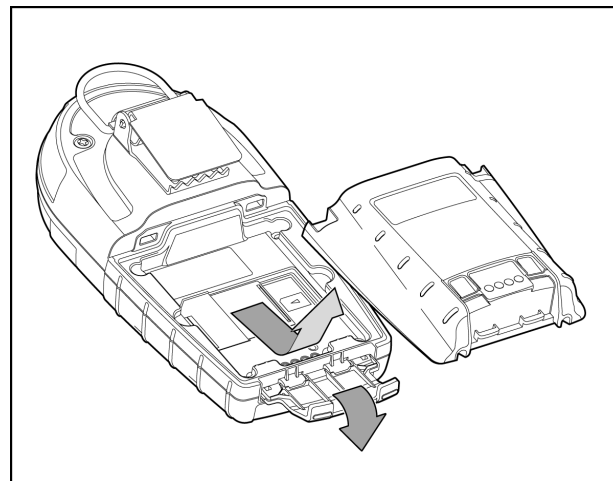

Figure 9. Removing the Micro 5/PID/IR Lithium Battery Pack

1. Open the latch on the bottom of the detector.
2. Remove the battery pack by lifting the bottom of the pack upward from the detector.

Warning

Do not disassemble lithium battery packs.

3. Hold the battery pack (serial number label down) at a 45° angle and insert the bottom into the detector bay.

Ensure that the connector outlets on the bottom of the battery pack lock into place over the connector pins in the docking bay, and then lower the top into place.

4. Lower the lid and press down until the release tabs click.

The base station beeps and the Charge Status LED lights red.

Inserting the GasAlertMicroClip / GasAlertMicroClip XT

⚠ Caution

Infrared or intense ambient light (sun or halogen) may interfere with the base station/detector communication.

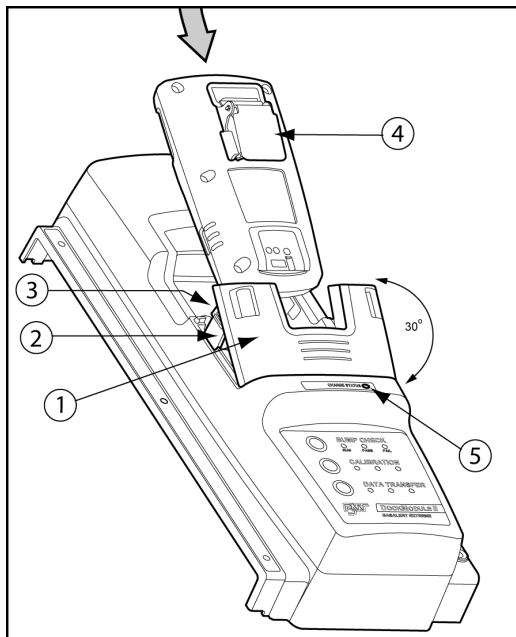

Figure 10. Inserting the GasAlertMicroClip / GasAlertMicroClip XT

Note

GasAlertMicroClip is shown in Figure 10.

Table 10. Inserting the GasAlertMicroClip / GasAlertMicroClip XT

Item	Description
1	Module lid
2	Release tabs
3	Detector bay
4	Alligator clip
5	Charger status indicator

Note

If the GasAlertMicroClip / GasAlertMicroClip XT is fitted with a calibration cap or auxiliary filter, it must be removed prior to inserting the detector into the docking module.

1. Activate the detector and wait until it is in normal operation.
2. Press the two release tabs on the docking module and raise the lid.

⚠ Warning

The docking module lid only raises upward 30° angle. Do not force the lid beyond its limit.

3. Insert the bottom of the detector (serial number label up) at a 30° angle into the detector bay and then lower the top into place.

4. Lower the lid and press down until the release tabs click.

When the detector has been inserted correctly, the RUN LED(s) on the docking module lights yellow and the base station LCD displays the

- the docking module number,
- **Unit Inserted**,
- detector type, and
- detector serial number.

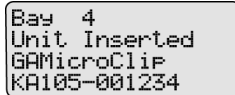

```
Bay 4
Unit Inserted
GAmicroClip
KA105-001234
```

Note

When the detector is inserted, the base station LCD displays GasAlertMicroClip.

Use the serial number prefix to differentiate between GasAlert-MicroClip (KA1, KA2, KA3) and GasAlertMicroClip XT (KA4).

5. To bypass the base station identification screen, press any  button on the base station.

Inserting the GasAlertMax XT / GasAlertMax XT II

⚠ Caution

Infrared or intense ambient light (sun or halogen) may interfere with the base station/detector communication.

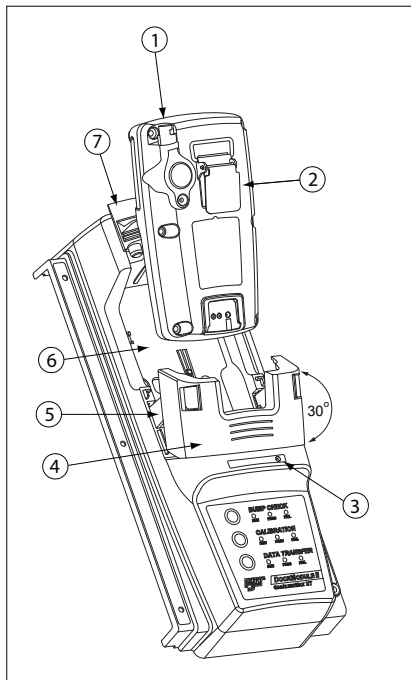

Figure 11. Inserting the GasAlertMax XT / GasAlertMax XT II

Table 11. Inserting the GasAlertMax XT / GasAlertMax XT II

Item	Description
1	Detector pump
2	Alligator clip
3	Charge status
4	Module lid
5	Release tabs
6	Detector bay
7	Pump connector

1. Activate the detector and wait until it is in normal operation.
2. Ensure the alligator clip is closed and the ring is resting flat on the detector to prevent disruptions with data transmission.
3. Ensure the pump connector is pushed up.
4. Press the two release tabs on the docking module and raise the lid.

⚠ Warning

The docking module lid only raises upward at a 30° angle. Do not force the lid beyond its limit.

5. Insert the bottom of the detector (serial number label up) at a 30° angle into the detector bay and then lower the top into place.
6. Push the pump connector towards the detector pump.

Note

The detector will briefly alarm when the pump connector is inserted. This is normal. The alarm will deactivate when the detector is properly inserted into the docking module.

Ensure the arrow on the dock is aligned with the guides on the pump connector.

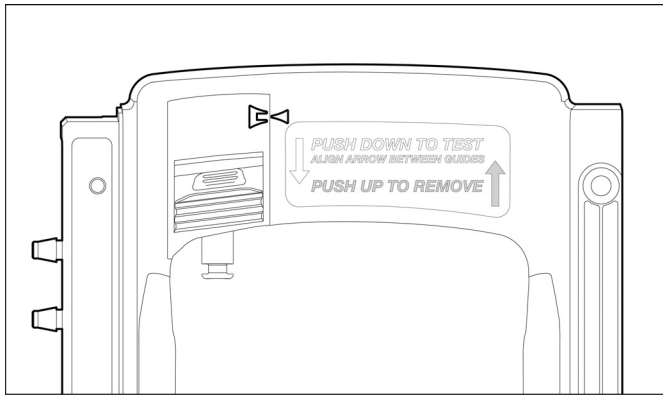

Figure 12. Aligning the Arrows on the GasAlertMax XT / GasAlertMax XT II Docking Module

7. Lower the lid and press down until the release tabs click.

When the detector has been inserted correctly, the RUN LED(s) on the docking module lights yellow and the base station LCD displays the

- the docking module number,
- **Unit Inserted**,

- detector type, and
- detector serial number.

```
Bay 4
Unit Inserted
GasAlertMax XT
MA107-00874
```

8. To bypass the base station identification screen, press any  button on the base station.

⚠ Caution

When removing the detector, ensure the pump connector has been pushed up first.

Inserting the GasAlertQuattro

⚠ Caution

Infrared or intense ambient light (sun or halogen) may interfere with the base station/detector communication.

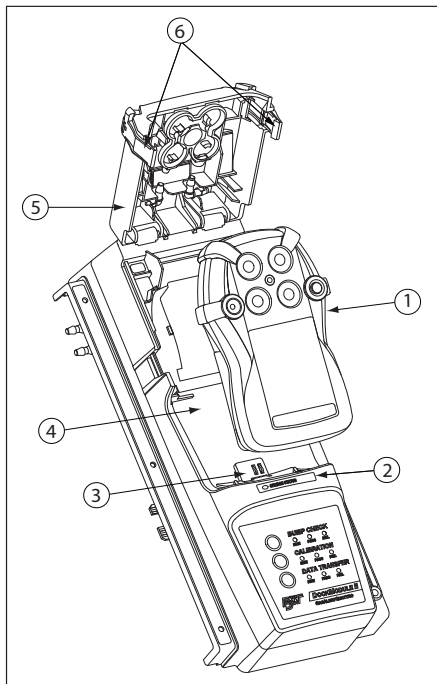

Figure 13. Inserting the GasAlertQuattro

Table 12. Inserting the GasAlertQuattro

Item	Description
1	GasAlertQuattro
2	Charge status
3	Connector pins
4	Detector bay
5	Module lid
6	Release tabs

Note

If the GasAlertQuattro is fitted with a calibration cap or auxiliary filter, it must be removed prior to inserting the detector into the docking module.

When the GasAlertQuattro is inserted into a docking module, the detector may take up to 20 seconds before beginning charging.

1. Activate the detector and wait until it is in normal operation.
2. Ensure the alligator clip is closed and the ring is resting flat on the detector to prevent disruptions with data transmission.
3. Press the two release tabs on the docking module and raise the lid.
4. Insert the bottom of the detector (LCD up) at a 30° angle into the detector bay and then lower the top into place.

5. Close the lid and press until the release tabs click.

When the detector has been inserted correctly, the RUN LED(s) on the docking module lights yellow and the base station LCD displays the

- the docking module number,
- **Unit Inserted,**
- detector type, and
- detector serial number.

```
Bay 4
Unit Inserted
GasAlertQuattro
QA108-001874
```

The detector's LCD displays the following screen.



6. To bypass the base station identification screen, press any  button on the base station.

Inserting the GasAlertQuattro Battery Pack

To insert the GasAlertQuattro battery pack into the detector bay, refer to Figure 14. and the following procedure.

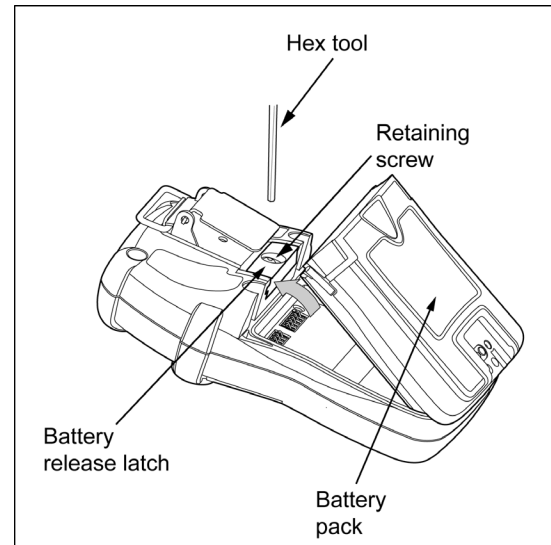

Figure 14. Removing the GasAlertQuattro Battery Pack

1. Deactivate the detector.
2. Push the battery release latch toward the top of the detector to release the battery pack.
3. From the top of the battery pack, lift the battery pack upward to remove.

4. Insert the bottom of the battery pack (serial number label down) at a 30° angle into the detector bay and then lower the top into place.

The docking module beeps and the Charge Status LED lights red.

Adding Another Docking Module

If required, refer to [Using the Base Station](#) before adding a docking module.

Warning

Only one module can be connected at a time. Complete steps #1-20 for each docking module that is added.

To add another docking module, refer to

- [Table 13.](#)
- [Table 14.](#),
- [Figure 15.](#),
- [Figure 16.](#), and
- [Figure 17.](#),
- and complete the following procedures:

Table 13. Torque Specifications

Housing Assembly	Torque
Alligator clip	4-5 in lbs
Wall mounting plate	9-10 in lbs

Table 14. Adding Another Docking Module

Item	Description
1	Phillips pan-head screw (3)
2	End plate
3	Barbed fitting ports
4	Gasket block
5	Phillips flat-head screw
6	PCB connectors
7	Bottom cover plate

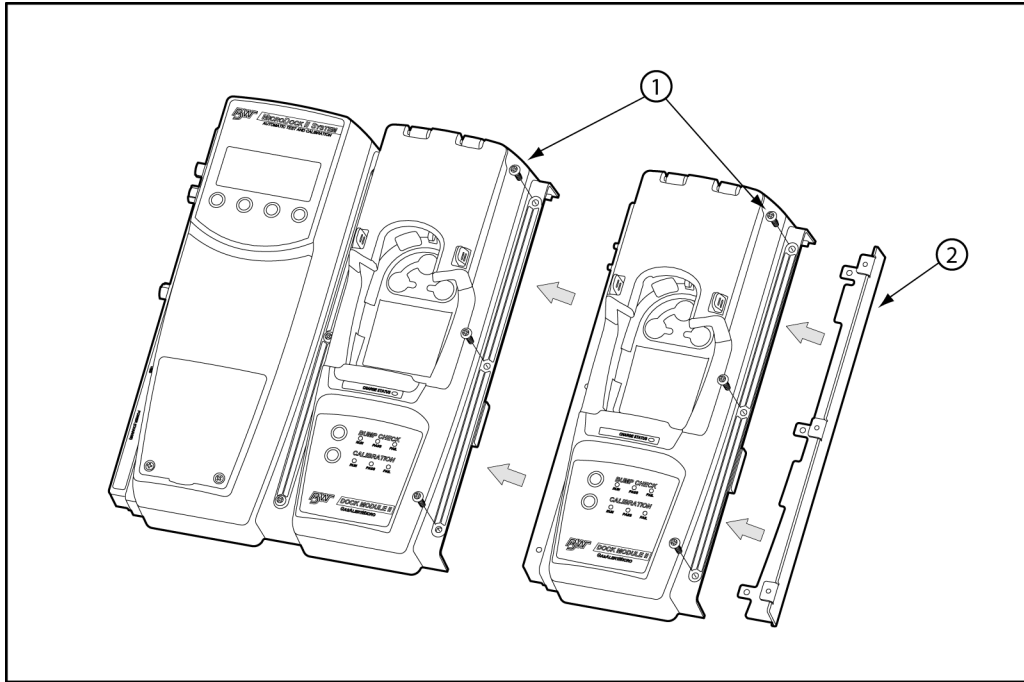

Figure 15. Adding Another Docking Module (Front View)

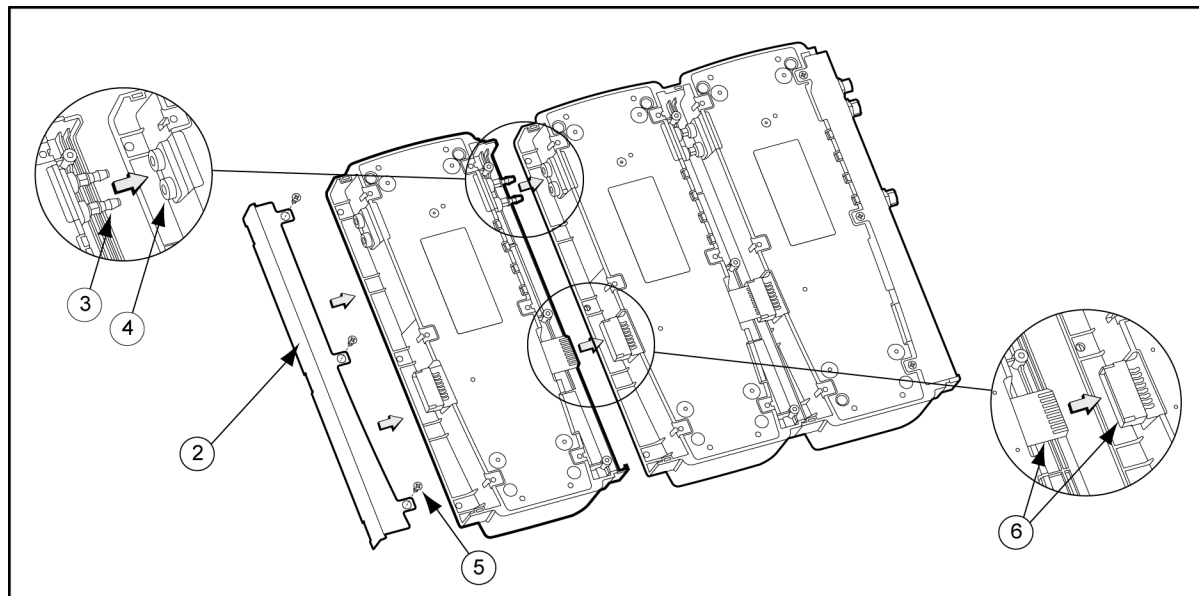

Figure 16. Adding Another Docking Module (Back View)

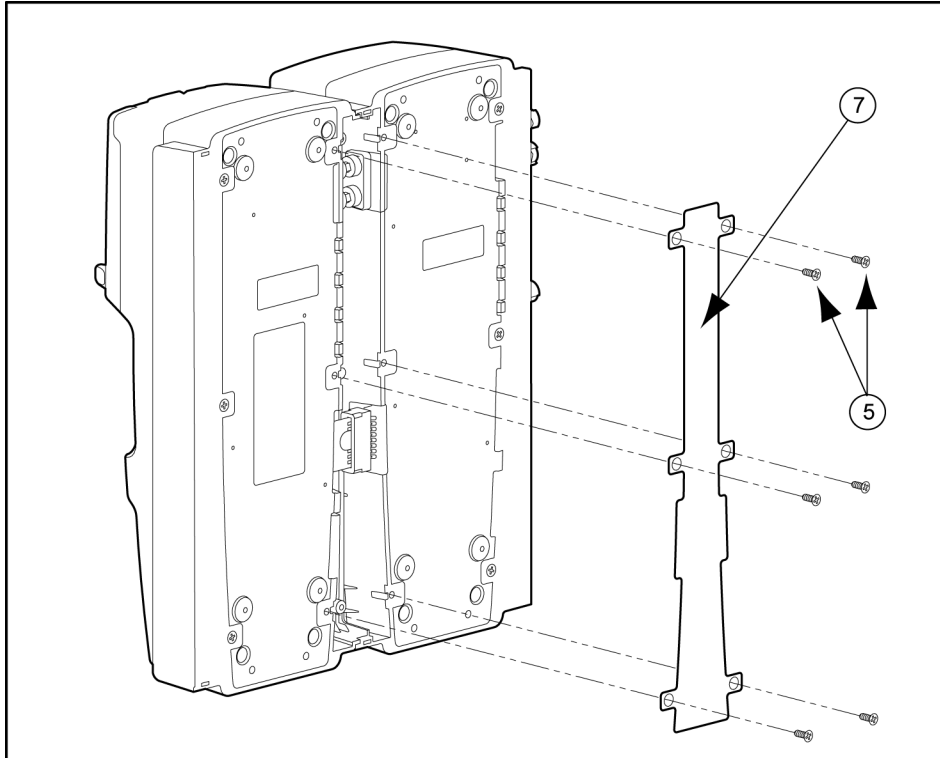

Figure 17. Attaching Back Cover Plate (Back View)

1. Deactivate the base station.
2. Remove the power cord from the POWER port. If applicable, remove the charger cord from the CHARGER port.
3. Remove the end plate. There are three Phillips screws on the front and three Phillips screws on the back.
4. Attach the new docking module.

Ensure the barbed fitting ports mate correctly with the gasket block. Ensure that the male and female PCB connectors mate correctly.

Initializing the New Docking Module

When a new docking module is connected, it must be initialized (setup to communicate with the base station).

5. Simultaneously press and hold BUMP CHECK on the new docking module while pressing (leftmost button) on the base station.
6. All of the LEDs on the new docking module light. On the base station LCD, the following screen displays to confirm that the new docking module has been successfully added.

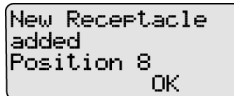

```
New Receptacle
added
Position 8
      OK
```

7. Press **OK**.
8. Deactivate the base station.

⚠ Caution

The base station must be deactivated after each module has been added.



Defining Pump Speed

The pump speed must be defined for each new docking module that is connected.

⚠ Warning

Perform the pump setup procedures in a fresh air environment. Do not perform the pump setup procedures in a hazardous area.

1. Reactivate the base station and wait until it enters normal operation.
2. Connect a hose to a flow meter and to inlet 1 (PURGE) on the base station.

Allow the flow meter sufficient time to stabilize (approximately 30 minutes) before using it to ensure accurate flow readings.
3. From the base station, access the user options menu.
4. Press  or  to scroll to the **Pump Setup** option.
5. Press **sel** to activate the pump setup field (■ changes to ⚡).

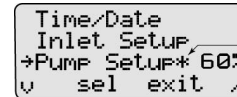









```
Time/Date
Inlet Setup
→Pump Setup* 60%
w sel exit ^
```

The base station immediately begins pumping the ambient air.

The factory default pump speed displays beside **Pump Setup**. The base station pump speed is measured as a percentage (%) and the flow meter measures speed in ml/min.

Note

The base station is shipped with the factory default pump speed set to 350 ml/min. (60%).

6. Monitor the flow meter until it stabilizes (5-20 minutes depending upon the type of flow meter).
7. From the base station, press   or   until the flow meter displays 350 ml/m.
8. From the base station, press  **exit** to save the new value and exit the **Pump Setup** field ( changes to ).
9. Press  **exit** again to return to normal operation.
10. Repeat steps # 1-17 for each docking module that is added. Continue to step #18 and 19 for the last module added.
11. After all of the modules have been added, attach the end plate. Refer to [Figure 15](#).
12. Fasten the bottom cover plate to the space between the two docking modules using six Phillips flat-head screws. Refer to [Figure 17](#).

Note

When assembling or reassembling parts of the base station and docking modules, refer to the [Table 13](#).

Mounting the MicroDock II

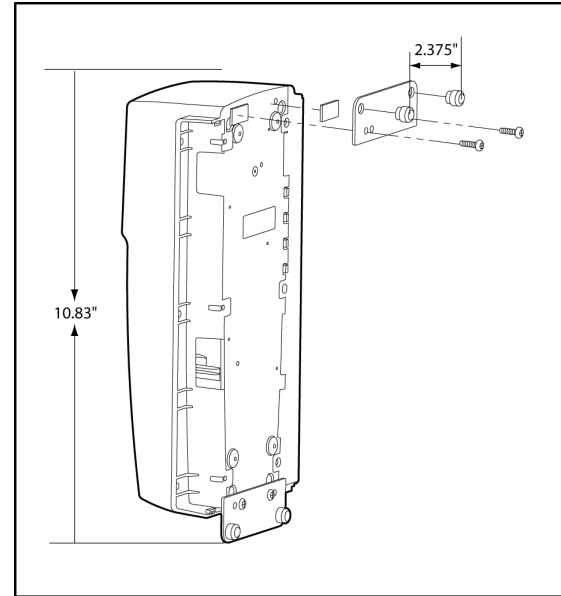

Figure 18. Attaching the Wall Mounting Plate

Note

When mounting two or more docking modules, each docking module requires an individual set of wall mounting plates.

Because of the variety of surfaces that the base station can be mounted to, mounting screws are not provided.

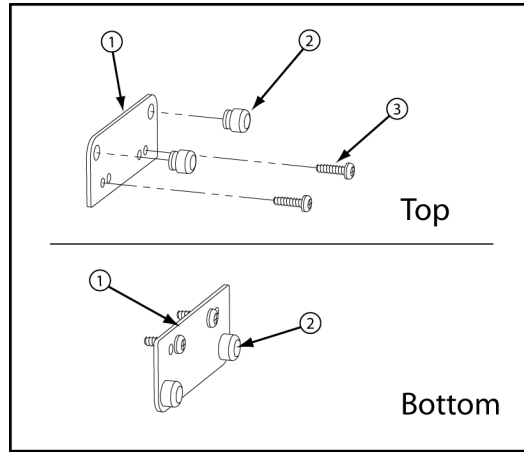

Figure 19. Parts of the Wall Mounting Plate

Table 15. Mounting the MicroDock II

Item	Description
1	Wall mounting plate (2)
2	Grommet (4)
3	Phillips self-tapping screw (8)

The base station and docking modules can be easily mounted to a secure surface. To mount the base station and docking modules, complete the following:

1. Determine a secure location to mount the base station.

Using the screws that are provided, attach the wall mounting plates to the base station and docking modules.

2. When the plates are mounted on the base station, measure horizontally on the wall a distance of 2.38 in. (60.32 mm) for the base station width.
If mounting two or more docking modules that are attached on the wall, measure horizontally on the wall a distance of 1.64 in. (41.7 mm) of space between each docking module.
3. Use four screws to attach the base station to the secure surface.

Changing Dip Switch Settings (*GasAlertClip Extreme only*)

The gas type for bump tests is defined by setting the dip switch within the GasAlertClip Extreme docking module.

Table 16. Dip Switch Settings

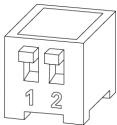
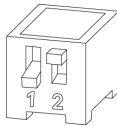
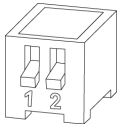
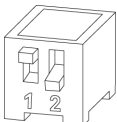
Gas Type	Dip Switch Setting
Sulphur dioxide (SO ₂)	
Oxygen (O ₂)	
Hydrogen sulfide (H ₂ S)	
Carbon monoxide (CO)	

To change the dipswitch setting on a GasAlertClip Extreme docking module refer to Tables 15 and 16, Figures 16 and 17, and complete the following:

1. Deactivate the base station.
2. Remove the three Phillips pan-head screws from the front and the six Phillips flat-head screws from the back cover plate.
3. Gently separate the docking module from the base station or other docking modules. Refer to [Figure 20](#).
4. Configure the gas type by setting the dip switches to the desired gas. Refer to [Table 16](#) for gas type and dip switch settings.
5. Reconnect the GasAlertClip Extreme docking module. Refer to [Figure 21](#).
Refer to [Table 13](#) for torque specifications.
6. Fasten the bottom cover plate using the six Phillips flat-head screws. Fasten the remaining three Phillips pan-head screws to the top of the docking module.

Table 17. Changing Dip Switch Settings

Item	Description
1	Bottom cover plate
2	Phillips flat-head screw (6)
3	Phillips pan-head screw (3)
4	Barbed fitting ports
5	Dip switch

Note

When reattaching the docking module, ensure the barbed tubing is inserted correctly. Ensure to correctly label the gas type on the docking module.

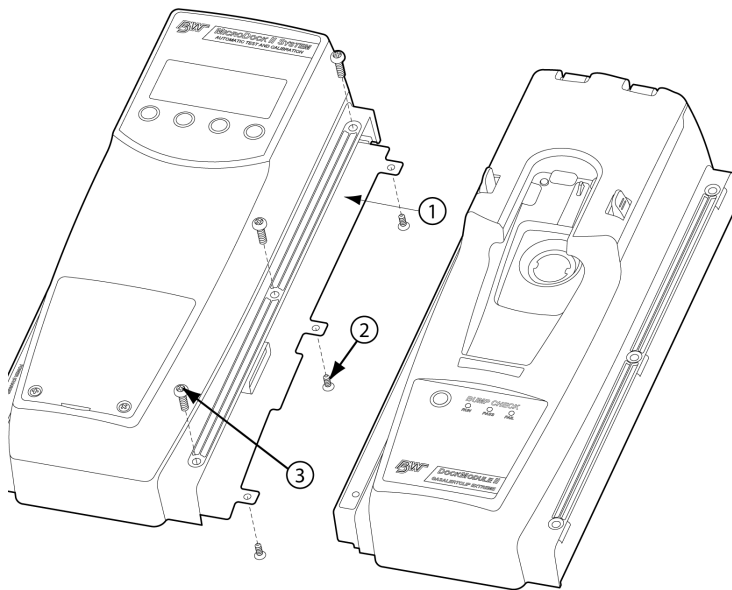

Figure 20. Detaching the GasAlertClip Extreme Module

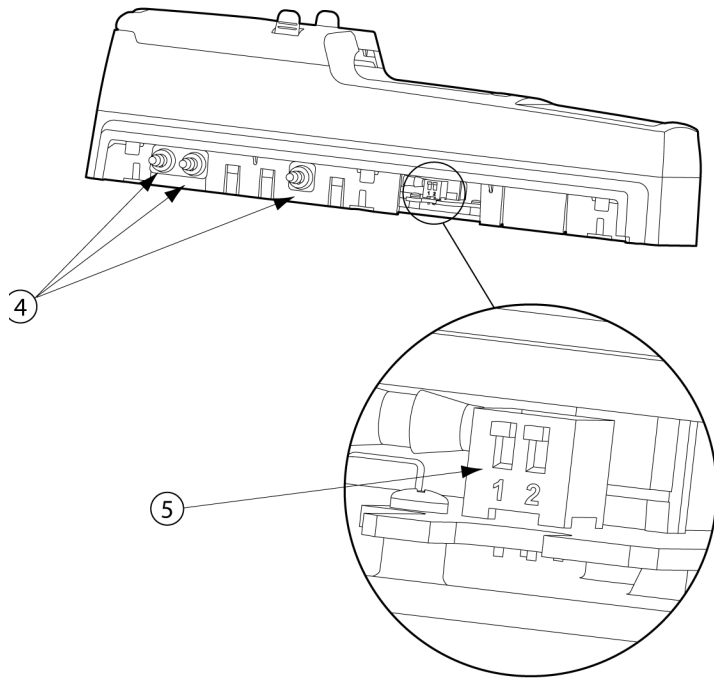



Figure 21. Changing Dip Switch Settings

Using the Base Station

⚠ Warning

To prevent possible injury and/or property damage, only use the base station in a fresh air environment. Do not use the base station in a hazardous area.

Ensure that the base station is attached to a venting system or used in a well ventilated area.

The base station pushbuttons are not labelled. The base station is operated by pressing the  pushbutton that is located directly below the text that displays on the LCD.

Confirming Inlet Setup

⚠ Warning

Failed tests can result if the inlets are not setup correctly.

Before activating the base station for the first time, ensure that the gas cylinders are connected to the inlets correctly. Refer to [Installation](#). To confirm that the inlets are setup correctly, refer to [Inlet Setup](#) in the [User Options Menu](#) section.

Note

If not using the base station in a fresh air environment, use a zero air gas cylinder for Inlet 1.

Activating the Base Station

To activate the base station, complete the following:

1. Connect power to the base station. Refer to [Installation](#).

2. Press and hold  (the left most button) until the initializing screen displays.

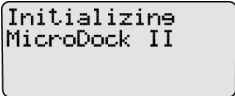

```
Initializine  
MicroDock II
```

The base station enters normal operation.

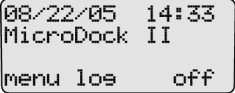

```
08/22/05 14:33  
MicroDock II  
menu los off
```

Self-Test

The base station automatically performs a self-test during startup.

Docking Module/Detector: The base station checks for connected docking modules and inserted detectors.

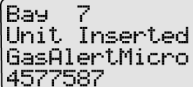

```
Bay 7  
Unit Inserted  
GasAlertMicro  
4577587
```

The LCD displays information about the docking modules, the detector type, and the detector serial number.

If a detector is inserted but not activated, the LCD displays the following message.

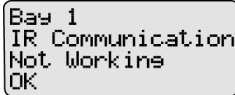

```
Bay 1
IR Communication
Not Working
OK
```

Press **OK** to acknowledge the error message.

Batteries: The batteries are tested during activation and continuously thereafter. If battery power is extremely low, low battery icon  flashes.

MultiMediaCard (MMC) / Secure Digital (SD) Card: The MMC/SD card icon () displays continuously on the base station LCD during normal operation when the MMC/SD card is inserted. The MMC/SD card records a variety of data.

Pass Code Protection: If the base station is pass code protected, the pass code protect icon  displays on the base station LCD during normal operation.

Deactivating the Base Station

To deactivate the base station, it must be in normal operation. From the normal operation screen, press and hold (the rightmost button) until **Powering Down** displays.

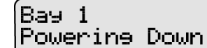

```
Bay 1
Powering Down
```

The powering down screen displays briefly before the base station deactivates.

User Options Menu

The user options menu provides access to ten options. The following user options are listed in the order they are displayed on the base station LCD.

Note



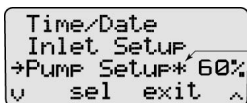

Bump tests or calibrations cannot be performed while accessing the user options menu. However, if a test is initiated before or while accessing the user options menu, the test automatically begins after exiting the user options menu.

To access the user options menu, complete the following:

1. Press and hold  **menu** to access the first screen.







If the base station is pass code protected, refer to [Entering User Options When Pass Code Protected](#).

2. Press  or  to scroll to different options. When  displays beside the desired option, press  **sel** to select.
3. To exit the options menu and return to the normal operation, press  **exit**.

Time/Date

Time/Date adjusts the time (hour/minute), the date (month/day/year) and the day of the week (1-7) of the base station.

To change the date, time, and/or day of the week, complete the following:

1. From the user options menu, press   or   to scroll to the **Time/Date** option.

Press  **sel** to confirm the selection and access the time/date screen.

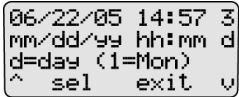
	mm: month
	dd: day
	yy: year
	hh: hour
	mm: minute
	d: day of the week Monday = 1 , Tuesday = 2 , Wednesday = 3 , etc.

Note

*The time and date values can only be changed in the order they are presented in this table. To bypass any time/date setting, press  **sel**. The base station automatically retains the current value and proceeds to the next date/time value.*

The cursor automatically displays below the first value of the month. Each value is selected, changed, and bypassed individually.

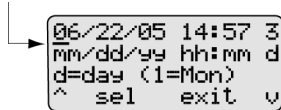

2. Press **↔** to toggle between **0** or **1**. When the correct value displays, press **sel** to confirm the change. The cursor then automatically moves to the second value of the month.

Or

Press **sel** to bypass the first value. The base station automatically retains the current value and proceeds to the second value of the month.

3. Repeat step #2 for the remaining time and date values.
4. Press **exit** to return to the user options menu.
5. Press **exit** again to return to normal operation.

Inlet Setup

Inlet Setup defines the

- the gas type(s)
- the corresponding gas concentrations level(s), and
- the gas cylinder lot # of each selected gas.

⚠ Warning

Failed tests can result if the inlets are not setup correctly.

For initial base station activation, ensure the inlets are installed correctly as follows:

- Inlet 1 is the default connection for ambient air.
- Inlet 2 is the default connection for four-gas mix, unless otherwise specified at purchase.
- Inlets 3-5 are designed connections for additional gases. However, unless specified at the time of purchase, inlets 3-5 are configured for ambient air.

To confirm that the inlets are setup correctly, complete the following:

1. From the user options menu, press **↔** or **↑↓** to scroll to the **Inlet Setup** option.
2. Press **sel** to confirm the selection and access the inlet 1 (ambient air) screen.

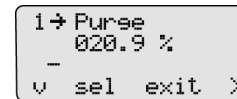

Note

Inlet 1 is designated for ambient air only and cannot be changed.

3. From the inlet **1** screen, press **>** to access the inlet **2** screen.

Continue to press $\bigcirc \rightarrow$ to access the inlet 3, 4, and 5 screens. O_2 displays as the default gas type when each of the inlet screens are accessed for the first time.

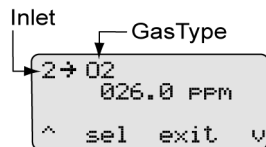

The inlet screens (2-5) have three options to modify:

- [Gas Type](#)
- [Gas Concentration Level](#)
- [Gas Cylinder Lot # Field](#) (field initially displays blank until data is entered).

There are two types of screens:

- Single gas

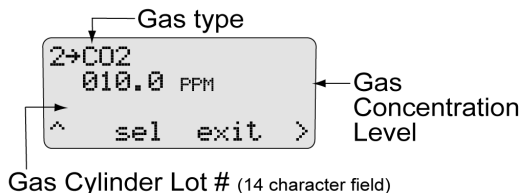

- Multi-gas Type Screen

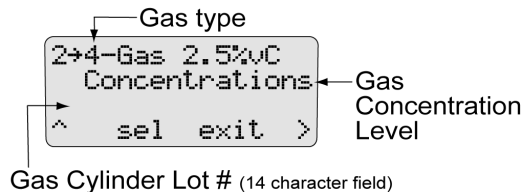

- To select a gas type, proceed to [Gas Type](#). Refer to [Table 17](#), for available gas types.

Gas Type

There are 33 gas types to select from. Refer to the following table.

Table 18. Inlets 2-5 – Available Gas Types

Gas Type	Gas Concentration	
<i>Note</i>		
<i>* indicates that the gas concentration level can be modified on the base station.</i>		
Purge (ambient air)	%	
O₂ (oxygen)	%	
NH₃ (ammonia)	ppm	*
CO (carbon monoxide)	ppm	*
ETO (ethylene oxide)	ppm	*
H₂ (hydrogen)	ppm	*

Gas Type	Gas Concentration	
Cl₂ (chlorine) bump only	ppm	*
HCN (hydrogen cyanide)	ppm	*
H₂S (hydrogen sulfide)	ppm	*
NO (nitric oxide)	ppm	*
NO₂ (nitrogen dioxide)	ppm	*
PH₃ (phosphine)	ppm	*
SO₂ (sulfur dioxide)	ppm	*
Ethanol	% LEL	*
Ethanol Equiv.	% LEL	*
Hexane	% LEL	*
Hexane Equiv.	% LEL	*
Methane	% LEL	*
Methane Equiv.	% LEL	*
Pentane	% LEL	*
Pentane Equiv.	% LEL	*
Propane	% LEL	*
Propane Equi	% LEL	*
4 – Gas 2.5%vCH₄ (H ₂ S, CO, LEL, O ₂)	ppm and %LEL	
4 – Gas Equiv.	ppm and %LEL	

Gas Type	Gas Concentration	
Custom 4-Gas	ppm and %LEL	*
Custom 3-gas	ppm and %LEL	*
Custom 2-Gas	ppm and %LEL	*
3 – Gas SO₂ Mi (3-gas mix)	ppm and %LEL	
Isobutylene	ppm	*
LEL	%LEL	*
CO₂	ppm	*
CO₂ zero / N₂ (nitrogen)	ppm	*

Note

Scroll through options and functions when \rightarrow displays. \leftarrow displays when a field is selected and can be modified.

To select a gas type, complete the following:

- From the required inlet screen, \rightarrow displays.

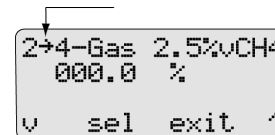

- If the required gas type is displayed, press \downarrow to move down to the gas concentration level. Proceed to the [Gas Concentration Level](#) section.

- To select a different gas type, press **sel.** \rightarrow changes to \star to indicate that the field is activated. Press \downarrow or \uparrow to scroll through the list of gas types.
- When the desired gas type displays, press **sel.** \star changes to \rightarrow to confirm the new selection and to deactivate the field.
- To enter the gas concentration level for the selected gas, proceed to the following section [Gas Concentration Level](#).
Or
Press **exit** to return to the user options menu.
- Press **exit** again to return to normal operation.

Gas Concentration Level

Depending upon the gas type selected, **ppm**, **%LEL**, or **%** displays beside the gas concentration level.

Note

The following gas concentrations are factory configured and cannot be changed:

- Four-gas-mix (4-Gas 2.5% vCH₄)*
- Four-gas equivalent (4-Gas Equiv.)*
- Three-gas SO₂ mix (3-Gas SO₂ Mi)*
- The Custom 4-Gas, Custom 3-Gas, and Custom 2-Gas can be modified. However, only the gas concentration levels can be changed.*

- Press \uparrow to move \rightarrow down to the gas concentration level.

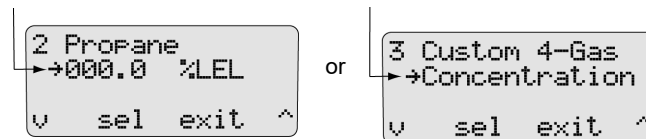

- Press **sel.** If the gas concentration level can be modified, \rightarrow changes to \star and the cursor displays below the first value.

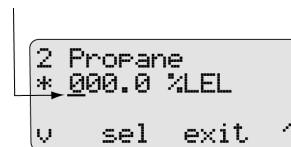

For custom and multi-gas: All of the applicable gases display (for 4-Gas press \uparrow to scroll to the remaining gas types currently not displayed).

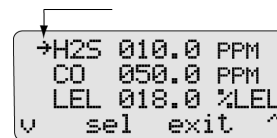

Press **sel** to select the required gas. **→** changes to ***→** and the cursor automatically displays below the first value.

```

*H2S 010.0 PPM
CO 050.0 PPM
LEL 018.0 %LEL
v sel exit ^

```

13. Press **▲** or **▼** to scroll to the required value. Press **sel** to save the new value.
Or
Press **sel** to retain the current value. The cursor automatically moves to the next value.
14. Repeat step #13 for the remaining values, then press **exit**. ***→** then changes back to **→**.
15. To enter a lot number for the corresponding gas cylinder, proceed to [Gas Cylinder Lot # Field](#).
Or
Press **exit** to return to the user options menu.
16. Press **exit** again to return to normal operation.

Gas Cylinder Lot # Field

Although this field is designed to enter the lot number of the corresponding gas cylinder, other types of data can be entered. A maximum of 14 characters (letters and/or numbers) can be selected.

17. Press **▼** to move down to the lot number field. Initially this field is blank.

```

2 4-Gas 2.5%vCH4
  000.0
  v sel exit ^

```

18. Press **sel**. **→** changes to ***→** and the cursor displays for the first value.

```

2 4-Gas 2.5%vCH4
  000.0
  * _
  v sel exit ^

```

19. Press **▲** or **▼** to scroll to the first desired letter/number. Press **sel** to accept the value and automatically move the cursor to the next space.

20. Repeat step #19 for the remaining values.

The following screen displays the corresponding lot number for the attached gas cylinder.

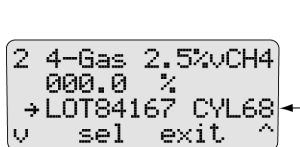

21. Press **○ exit**. ***:** changes back to **→**.

22. To setup another inlet, repeat the procedures listed in the [Gas Type](#), [Gas Concentration Level](#), and the [Gas Cylinder Lot # Field](#) sections.

23. When all of the entries are completed, press **○ exit** to return to the user options menu.

24. Press **○ exit** again to return to normal operation.

Pump Setup

Refer to [Defining Pump Speed](#) in the [Adding Another Docking Module](#) section.

Contrast

Contrast brightens or darkens the LCD. To adjust the contrast level, complete the following:

1. From the user options menu, press **○ ↘** or **○ ↙** to scroll to the **Contrast** option.

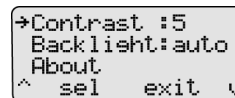

2. Press **○ sel** to confirm the selection and access the field (**→** changes to ***:**).

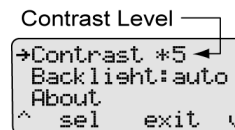



The contrast levels range from **2** (brightest) to **10** (darkest).

Note

The base station is shipped with the contrast level defined as 5.

3. Press **○ ↘** or **○ ↙** to select the desired contrast level.
4. Press **○ sel** to save the new value and exit the field (***:** changes back to **→**).

5. Press  or  to scroll to another user option.

Or

Press **exit** to return to the normal operation.





Backlight

Backlight enables, disables, or selects auto mode for the LCD lighting. The **auto** mode automatically disables the backlight when the base station is not in use.

Note

*The base station is shipped with the auto backlight option enabled. While operating from battery power only, select **auto** mode or  (off) to conserve the batteries.*



To enable/disable or select **auto** backlight, complete the following:

1. From the user options menu, press  or  to scroll to the **Backlight** option.
2. Press **sel** to select the option and access the field ( changes to .





```

Contrast :5
→Backlight:auto
About
^ sel exit v
    
```

3. Press  or  to scroll through the options.



	Enabled
	Disabled
auto	Automatic

Each selection displays beside **Backlight** and the backlight activates and deactivates, depending upon the selection.

4. Press **sel** to save the selection and exit the field ( changes back to .
5. Press  or  to scroll to another user option.
Or
Press **exit** to return to normal operation.

About

About displays the firmware revision for the base station and each docking module that is connected. To view the firmware revision for the base station and docking module(s), complete the following:

1. Press  or  to scroll to the **About** option.

```

Contrast :5
Backlight:auto
→About
^ sel exit v
    
```

Press **○ sel** to access the about base station screen.

```
Stn. M2BF-B03
M1 CSXF-01A
^      exit  v
```

If more than one docking module is connected to the base station, press **○ ↖** or **○ ↙** to scroll to the additional docking module firmware revisions (**M1 - M8**).

Note

Maximum eight docking modules can be connected to a station. There is a maximum limit of six charging modules. Six charging modules plus two non-charging modules can be connected to the station.

2. Press **○ exit** to return to the user options menu.
3. Press **○ exit** again to return to normal operation.

Formatting the MMC/SD Card

Format MMC formats the MultiMediaCard (MMC) or the Secure Digital (SD) card.

⚠ Caution

Formatting a MMC/SD card will erase all data on the card.

To format an MMC/SD card, complete the following:

1. Activate the base station if required.
2. On the base station, remove the cover from the battery compartment. Refer to [Battery Installation](#).

3. Insert the MMC/SD card into the slot above the battery compartment.

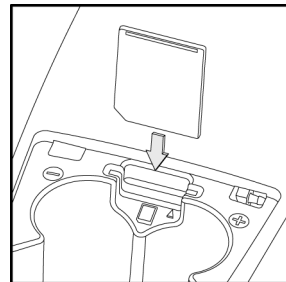

Figure 22. Inserting the MMC/SD Card into the Base Station

Note

If the MMC/SD card has never been formatted, the base station will automatically prompt to format the card (refer to steps #5-6).

4. Press **○ ↖** or **○ ↙** to scroll to the **Format MMC** option.

```
→Format MMC
Inlet Sel:manu
Pass Code:X
^ sel exit v
```

5. Press **sel** to confirm the selection and to access the formatting confirmation screen.

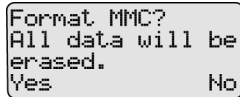

Format MMC?
All data will be
erased.
Yes No

6. Press **Yes** to initiate formatting. The following screen displays.

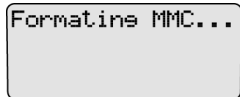

Formating MMC...

When formatting is complete, the LCD automatically returns to the user options menu.

If **No** is selected, the LCD automatically returns to the user options menu.

If there is a problem with the card, the following screen displays.

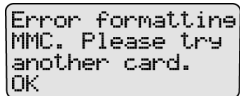

Error formating
MMC. Please try
another card.
OK

Press **OK** to acknowledge and insert a new card and repeat steps #4-6.

7. Press **↔** or **↑↓** to scroll to another user option.

Or

Press **exit** to return to normal operation.

For additional information about the MMC/SD card, refer to [Base Station MMC/SD Card](#).

Inlet Select

Note

Applicable only to custom and multi-gas types.

Inlet Sel enables either the automatic (**auto**) or manual (**manu**) function for selecting an inlet.

If the **auto** option is enabled, the base station automatically selects the correct gas inlet for the bump test or calibration.

If **manu** option is enabled, the applicable test gas must be selected each time a bump test or calibration is performed. If the **manu** option is enabled, refer to [Order of Gases Applied for Bump Tests and Calibrations](#) for important information.

To enable either the **auto** or **manu** option, complete the following:

1. From the user options menu, press **↔** or **↑↓** to scroll to the **Inlet Sel** option.

2. Press **sel** to confirm the selection and access the field (▣ changes to ✚).

```
Format MMC
→Inlet Sel* auto
Pass Code
^ sel exit v
```

3. Press ↖ or ↵ to toggle between the **auto** and **manu** option.
4. When the desired option displays, press **sel** to confirm the selection and exit the field (✚ changes back to ▣).
5. Press ↖ or ↵ to scroll to another user option.
Or
Press **exit** to return to normal operation.

Pass Code

The **Pass Code** option prevents unauthorized access to the user options menu. When the base station is pass code protected, ✚ displays during normal operation.

Note

The pass code is provided separately.

To enable/disable pass code protection, complete the following:

1. From the user options menu, press ↖ or ↵ to scroll to the **Pass Code** option.
2. Press **sel** to select the option and access the field (▣ changes to ✚).

```
Format MMC
Inlet Sel:manu
→Pass Code*✚
^ sel exit v
```

The current mode displays beside the **Pass Code** option.

✓	Pass code protect enabled
✚	Pass code protect disabled

3. Press ↖ or ↵ to toggle between the options.
4. When the desired option displays, press **sel** to confirm the selection and deactivate the field (✚ changes back to ▣).
5. Press ↖ or ↵ to scroll to another user option.
Or
Press **exit** to return to the normal operation.



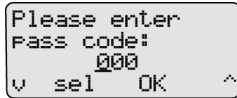

Entering User Options When Pass Code Protected

To access the user options menu when the base station is pass code protected, complete the following:

1. From the normal operating screen, press  **menu** to access the user options. The enter pass code screen displays.



The cursor displays below the first value.

2. Press   or   to scroll to the first number of the pass code.

When the correct value displays, press  **sel** to enter the first value. The cursor automatically moves to the next value.

3. Repeat step #2 for the remaining values.
4. Press  **OK**. If the correct pass code is entered, the user options menu displays.

Incorrect Pass Code Entered: If an incorrect pass code is entered, the base station automatically returns to normal operation.

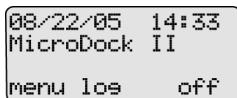

Repeat steps #1-4 to access the user options menu to try again.



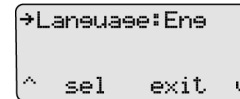

Language

The base station provides five language options and can display all text on the LCD in the following languages:

- English
- French
- German
- Portuguese
- Spanish



To select a different language, complete the following:



1. From the user options menu, press   or   to scroll to the **Language** option.

Note

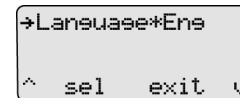

The base station is shipped with language defined as English (Eng).

2. Press  **sel** to confirm the selection and activate the field (⌂ changes to ⌘).





3. Press  or  to scroll to the different language options.
The available options are

- **Eng** (English),
- **Fran** (French),
- **Deut** (German),
- **Port** (Portuguese), and
- **Espa** (Spanish).

4. When the desired language displays, press **sel** to confirm the selection and exit the field ( changes back to ).

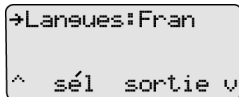
The LCD now displays all of the text in the selected language.



5. Press  or  to scroll to another user option
Or
Press **exit** to return to normal operation.

Note

exit now displays in the selected language.

Results History

The results history displays the results of the last ten bump tests or calibrations.

The newest results display first. The following test errors can occur:

- **Unit removed**
- **MMC error**
- **IR error**

Note

Deactivating the base station erases the results history log.

To view the results history log, complete the following:

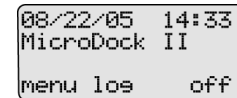

1. From the normal operating screen, press **log**.

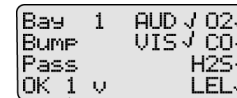

The most recent history log (1) displays.



↑
First log

2. To access the next log, press . Continue to press  to view the remaining logs.
3. Press **OK** to return to normal operation.

Reconfiguring the Detector *(not applicable to the GasAlertClip Extreme)*

Safety Suite Device Configurator (SSDC) can reconfigure the following detectors with the base station:

- GasAlert Extreme
- GasAlertMicro
- GasAlertMicro 5/PID/IR
- GasAlertMicroClip /GasAlertMicroClip XT
- GasAlertMax XT / GasAlertMax XT II
- GasAlertQuattro

The detector can be reconfigured prior to performing a bump test or calibration.

To reconfigure a detector, complete the following:

1. Activate the base station. Ensure it is in normal operation.
2. Ensure that a correctly formatted MMC/SD card is inserted in the base station. Refer to [Inserting/Replacing a MMC/SD Card](#).
3. Connect the USB cable to the computer and to the USB port on the base station.
4. From the computer, open and login to SSDC.
5. Under the **Device list view** tab, click on the checkbox next to the MicroDock II device.
6. At the top right corner click on **...**

7. The dropdown configuration menu displays.

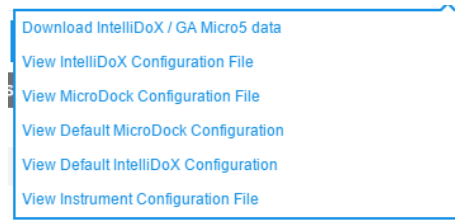

The following options are displayed for MicroDock II:

- **View MicroDock Configuration File**
- **View Default MicroDock Configuration**
- **View Instrument Configuration File**

8. Click on View Default MicroDock Configuration to see the available devices.

9. Select which device to configure by clicking its tab.

10. Configure the device.

Ensure the **Updatable** checkbox is checked.

11. Select a program option to reprogram the detector. Each detector has different reprogram options. Refer to Configuring Detectors in the *Safety Suite Device Configurator (SSDC) Operator's Manual*.

12. When the configuration is complete, click **Save to Dock**. The Device List configuration displays

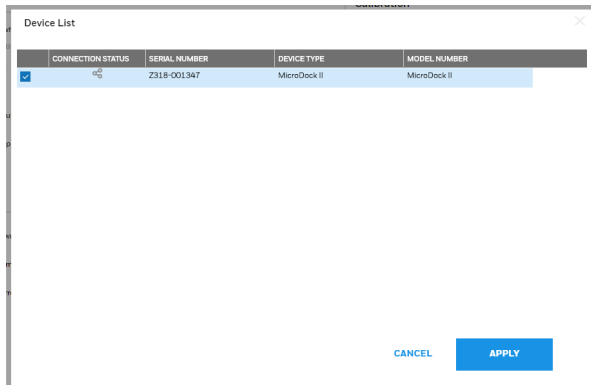

13. Select the checkbox to select a MicroDock II to save to and click on **Apply**

14. A dialog box displays the message **Successfully saved to Device**.

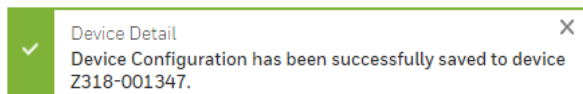

The detector configuration will be updated when the detector is inserted into the docking module, and a bump test or calibration is initiated.

16. Activate the detector and wait until it is in normal operation.

17. Insert the detector into the detector bay.

18. To reconfigure the detector, from the base station press BUMP CHECK or CALIBRATION.

If **Reprogram with user's consent** was selected under Program options, **Reconfigure detector?** displays on the base station LCD.

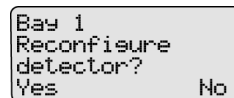

Press **Yes** to reconfigure the detector and proceed to the bump test or calibration.

Press **No** to bypass reconfiguration and proceed to the bump test or calibration.

19. When the base station is reconfiguring the detector, the following screen displays on the base station LCD.

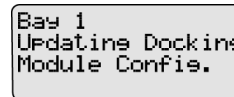

20. **Successful Reconfiguring:** If reconfiguration is successful, the following screen displays.

```
Bay 1
Reconfiguring
Detector...
```

Unsuccessful Reconfiguration: If reconfiguration is not successful, the following screen displays.

```
Bay 1
IR Interruption
Test Aborted
ok
```

Press **ok**. The LCD then returns to normal operation.

Resolving IR Errors: Refer to the following solutions. If the following solutions do not resolve the IR error, refer to [Troubleshooting](#).

- Check the lighting conditions. Infrared or intense light (sunlight or halogen) can cause IR disruptions.
- Remove and reposition the detector in the docking module.
- Communication between the detector and base station may have been temporarily disrupted. Complete the procedures again.

Gas Conflicts

When performing a bump test or calibration, gas must be applied in a specific order to prevent gas conflicts that can damage the detector's sensor(s).

Note

Ensure that the gas inlets are configured correctly. Refer to [Inlet Select](#).

The gas conflicts screen automatically displays if a gas conflict occurs when a bump check or calibration is initiated.

There are two types of gas conflicts:

- **Conflicts:** More than one inlet is configured for a specific gas type.
 - Example:** Inlet 2 is configured for SO₂ and inlet 3 is configured for the 3-gas SO₂ mix.
- **Not Found:** The base station is unable to locate the required gas type for a specific sensor on the detector.

The base station displays additional information regarding the

- number of gas conflicts,
- number of gases not found,
- docking module (e.g., **Bay 1**),
- detector gas type(s),
- inlet, and
- inlet gas type(s).

If a gas conflict is detected by the base station, the gas conflicts screen automatically displays.

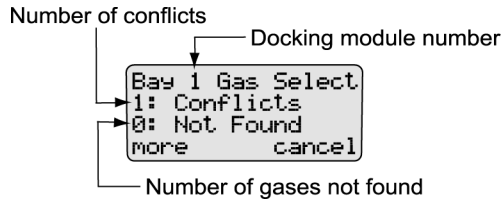

Refer to the following sections, [Conflicts](#) and [Not Found](#). Before proceeding to resolve gas conflicts, refer to the following section [Abort Option](#).

Abort Option

The **Abort** option is located in the gas conflicts screen. Selecting **Abort** exits the gas conflict function and the base station returns to normal operation. A bump test or calibration will not be performed.

Proceed to the user options menu and select the **Inlet Setup** option.

To abort a gas conflict, complete the following:

1. From the gas conflicts screen, press **more**.

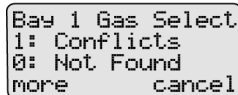

2. The conflicts/not found screen displays.

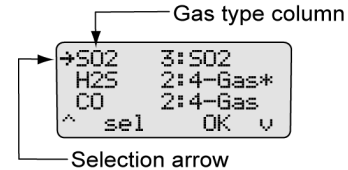

3. Press **↖** or **↙** to scroll to the **Abort Test** option.

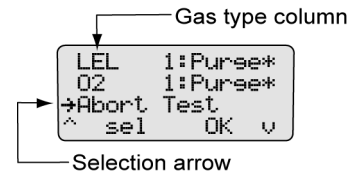

4. When **↔** displays beside **Abort Test**, press **sel** or press **OK**. The base station automatically exits the gas conflict and returns to the normal operation.

Conflicts

If a conflict occurs, it must be resolved to continue the bump test or calibration. The user may select the gas inlet or accept the gas inlet suggested by the base station.

Press **cancel** to exit the gas conflict screen and return to normal operation. A bump test or calibration will not be performed.

Base Station Selects the Gas Inlet

To resolve a conflict automatically, complete the following steps.

1. Press **more** in the gas conflicts screen to access the gas type/inlet screen to view which gas is configured for more than one inlet.

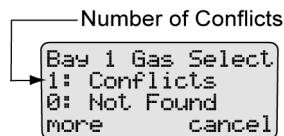

The gases display.

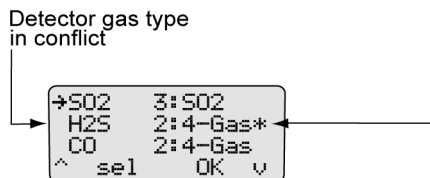

* displays on the row of the gas in conflict and indicates the inlet the station has selected

⚡ displays on the far right side on the row of the gas that is setup for more than one inlet. The ⚡ also indicates the inlet that the base station has selected as the optimum inlet.

2. Press **OK** to accept the inlet that is selected and automatically resume the bump test or calibration.

Note

If **sel** is not pressed within 30 seconds, the base station automatically defaults to the inlet it has selected.

User Selects Gas Inlet

1. Press **more** in the gas conflicts screen to access the gas type/inlet screen to view which gas is configured for more than one inlet.

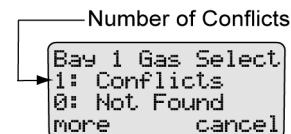

The gases display.

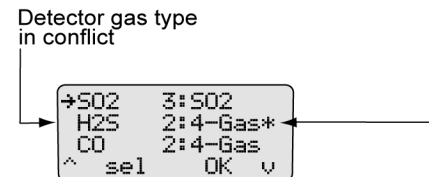

* displays on the row of the gas in conflict and indicates the inlet the station has selected

2. Press or to move to the gas that is in conflict.

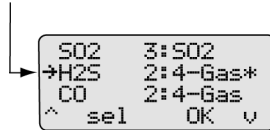

3. Press **sel** to access the inlet field. automatically displays on the left side of the inlet.

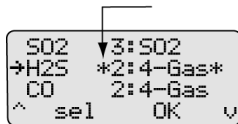

4. Press or to scroll to the desired inlet (1-5).
5. When the required inlet value displays, press **sel** to confirm the selection and exit the field. no longer displays to the right of the inlet, indicating the conflict has been resolved.

Note

If **sel** is not pressed within 30 seconds, the base station automatically defaults to the inlet it has selected.

Unsuccessful Conflict Resolution: If the conflict is not resolved by selecting a different inlet, refer to the following:

- Ensure that the selected inlet is correct.
- Ensure the gas cylinder that is attached to the selected inlet is correct.
- Press **OK** to accept the base station's default selection.

Not Found

If a value of **1** or more displays before **Not Found**, the base station is unable to locate the required gas type for a specific sensor on the detector.

Press **cancel** to exit the gas conflict screen and return to normal operation. A bump test or calibration will not be performed.

To define the gas inlets, complete the following.

1. Press **more** in the gas conflicts screen to access the gas type/inlet screen to view which gas type(s) cannot be found.

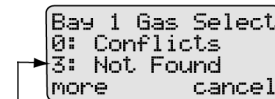

Number of gases not found

The gases display.

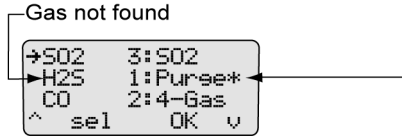

* displays on the row of the gas not found and indicates the inlet the station has selected

→ displays on the far right side of the gas that cannot be found. The base station automatically defaults to the **Purge** inlet.

2. Press **OK** to accept the default Purge inlet.

Or

Press **sel** to select a different inlet.

Note

*For gases not found: If sel is not pressed within 30 seconds, the base station automatically defaults to the **Purge** inlet.*

3. If required, repeat steps #1-2 for any additional gases not found and confirm the following:
 - Ensure that the selected inlet is correct.
 - Ensure that the gas cylinder attached to the selected inlet is correct.
 - Press **OK** to accept the base station's default selection.

Accessing the MMC/SD Card During a Test

If an attempt is made to access the MMC/SD card on the base station from a PC while a bump test or calibration is being performed, the following screen displays.

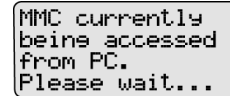

Note

BW recommends that bump tests and calibrations be completed before accessing test results from the PC.

Order of Gases Applied for Bump Tests and Calibrations

⚠ Warning

It is extremely important that gases are applied in the order that is specified in this manual.

Failure to adhere to the rules in [Table 19](#) and [Table 20](#) of this manual will result in incorrect sensor readings and possible personal injury and/or property damage.

Note

Manual application of gas types is available for the GasAlertMicro 5/PID/IR detectors only.

To manually apply gases for bump tests and calibrations, complete the following:

1. Review [Table 19](#) and [Table 20](#).
2. Determine which gases will be applied.
3. Using [Table 19](#), locate the first gas type (sensor) to be bump tested or calibrated on the top row.
4. Within the far left column, locate the next gas type (sensor) to be bumped or calibrated.

The square where the column and row intersect will indicate which gas should be applied first and a rule number (if applicable).

5. Using [Table 20](#), locate the corresponding rule number. Ensure that the desired order to apply gases corresponds to the gas application rules.
6. Continue to reference [Table 19](#) and [Table 20](#) to ensure the gases are applied in the correct order.
7. When the correct order is determined, proceed to the [Bump Test](#) or [Calibration](#) section.

Table 19. Gas Type Application Table

Gases	H₂S	CO	Cl₂ (Bump only)	NH₃	HCN	NO₂	COSH (H₂S/CO)	SO₂	PH₃	PID
H₂S		Quad gas	Cl ₂ Rule 4	NH ₃	HCN	NO ₂	quad gas - one step calibration	SO ₂	PH ₃ Rule 11	H ₂ S
CO			Cl ₂ Rule 5	NH ₃	HCN	NO ₂	quad gas - one step calibration	SO ₂	PH ₃ Rule 11	CO
Cl₂ Bump only				NH ₃ Rule 9	HCN	NO ₂ Rules 8 & 10	Cl ₂ Rule 6	Cl ₂ Rule 9	PH ₃ Rule 9	Cl ₂
NH₃					HCN Rule 9	NO ₂	NH ₃ Rule 6	NH ₃ Rule 9	PH ₃ Rules 9 & 10	NH ₃
HCN						HCN	HCN Rule 6	HCN Rules 8 & 10	PH ₃ Rules 8 & 10	HCN
NO₂							NO ₂ Rule 6	NO ₂	NO ₂ Rule 1	NO ₂
COSH H₂S/CO								SO ₂ Rule 6	PH ₃ Rules 10 & 11	COSH H ₂ S/CO
SO₂									PH ₃ Rules 9 & 10	SO ₂
PH₃										PH ₃
PID										

Table 20. Gas Application Rules

Rule #	Gas Type	Apply	Exception(s)
1	PH ₃	First	Two exceptions: NO ₂ and O ₃
2	HCN	First	Three exceptions: PH ₃ and ClO ₂
3	NO ₂	First	Three exceptions: HCN
4	H ₂ S	Last	One exception: PID
5	CO	Last	One exception: PID
6	COSH (H ₂ S/CO)	Last	One exception: PID
7	PID	Last	No exceptions
8	Toxic gas		Both toxic sensors are cross sensitive to each other – wait 5 minutes (minimum) between calibrations before verifying sensors.
9	2nd Toxic gas		Wait 5 minutes (minimum) after the second toxic gas is applied before verifying calibration. Verify calibration: Apply the same test gas from a different cylinder to ensure the calibration is successful.
10	Cross gas		Must perform individual calibrations to avoid incorrect calibration from cross gas
11	H ₂ S/PH ₃		H ₂ S contaminates PH ₃ – calibrate and verify PH ₃ sensor prior to applying any quad gas

Bump Test

A bump test is performed to confirm that the detector is responding to gas, and that the audio and visual alarms are operational.

The following detectors transfer their event logs to the base station MMC during a bump test:

- GasAlertClip Extreme
- GasAlert Extreme
- GasAlertMicroClip / GasAlertMicroClip XT
- GasAlertMax XT / GasAlertMax XT II
- GasAlertQuattro

⚠ Caution

Ensure the detector is not in a low battery state prior to performing a bump test.

Note

The base station cannot perform a bump test for O₃ and ClO₂ sensors.

If the GasAlertMicro, GasAlertMicro 5/PID/IR, GasAlertMicro-Clip / GasAlertMicroClip XT, GasAlertMax XT / GasAlertMax XT II, or GasAlertQuattro will be reconfigured, reconfiguration must be completed prior to performing a bump test. Refer to [Reconfiguring the Detector \(not applicable to the GasAlertClip Extreme\)](#).

To perform a bump test, complete the following:

1. Ensure the MMC/SD card is inserted if datalogging is required.

If the MMC/SD card is not inserted,  displays on the LCD when the base station attempts to write results to the MMC/SD card. If required, refer to [Inserting/Replacing a MMC/SD Card](#).

2. Activate the detector and wait until it is in normal operation. Insert it into the docking module.
3. Activate the base station and wait until it is in normal operation.
4. From the docking module, press  BUMP CHECK. The RUN LED lights yellow.

If a bump test is initiated while in the user menu: Bump tests are initiated after exiting the user options menu.

When the base station enters normal operation, the base station automatically begins the bump test.

If more than one docking module is queued: If more than one docking module is queued for a bump test, the first docking module queued begins the bump test.

The RUN LED flashes yellow on the remaining docking modules that are queued for a bump test. When the first module is complete, the next module in the queue begins the bump test.

5. Depending upon the type of detector, the option to reconfigure is provided.

If the detector was reconfigured without user's consent, the following screen displays.

```
Bay 1
Updating dockins
module confis.
```

If the detector was reconfigured with user's consent the following screen displays.

```
Bay 1
Reconfigure
detector?
Yes          No
```

To reconfigure the detector, press **Yes**. The MMC/SD card then transfers the new configuration data to the detector. If required, refer to [Reconfiguring the Detector \(not applicable to the GasAlertClip Extreme\)](#).

Or

Press **No** to continue with the bump test.

Note

*If a selection is not made within 15 seconds, the base station automatically defaults to the **No** selection and proceeds with the bump test.*

6. The base station begins the bump test and displays the

- docking module number,
- test being performed,
- detector type, and
- detector serial number.

```
Bay 1
Bump Checking
GasAlertMicro
4577587
```

Note

The serial number of the GasAlertClip Extreme does not display on the base station when performing a bump test.

The GasAlertMicro 5/PID/IR beeps and flashes twice to test the sensors when the bump check begins.

7. If there is a gas conflict or a selected gas cannot be found, the gas conflicts screen displays.

```
Bay 1 Gas Select
0: Conflicts
1: Unresolved
more      cancel
```

Gas conflicts must be resolved to continue the bump test. Refer to [Gas Conflicts](#).

If there are no gas conflicts, the base station then applies the gas.

```
2 O2
  000.0
Applying Gas...
```

If more than one gas is being applied, the base station performs a purge between each gas. Depending upon the gas type, the purge time(s) will vary.

⚠ Important

If the Automatic Datalog Download (GasAlertMicroClip / GasAlertMicroClip XT, GasAlertMax XT / GasAlertMax XT II, and GasAlertQuattro only) is enabled in Safety Suite Device Configurator (SSDC), data transfer automatically begins during the purge. Do not remove the detector until the DATA TRANSFER PASS LED lights, otherwise the transfer will fail.

For more information, refer to [Automatic Datalog Download](#).

```
Purge
20.9%
Applying gas...
```

8. After the bump test is complete, the base station displays the results of the bump test and performs a final purge to clear any remaining gas.

```
Bay 1  AUD ✓ O2 ✓
Bump   VIS ✓ CO ✓
Pass   H2S ✓
Purge  022  LEL ✓
```

The countdown of seconds remaining displays beside **Purge**.

Note

After a bump check is performed, the GasAlertMicro, GasAlert-Micro 5/PID/IR, GasAlertMicroClip / GasAlertMicroClip XT, GasAlertMax XT / GasAlertMax XT II, and GasAlertQuattro deactivate in 5 minutes if no activity is detected.

Bump Test Results

After the bump test is complete, the base station displays the results of the test.

✓	Pass
✗	Fail
H2S—	Gas type not detected (H ₂ S is used as an example, this applies to all gases)
—	Sensor is disabled

Bump Pass

```
Bay 1  AUD ✓ O2 ✓  
Bump   VIS ✓ CO ✓  
Pass   H2S ✓  
OK     LEL ✓
```

✓ indicates that the detector passed the bump tests. The detector is now ready for use. Press to return to normal operation.

Bump Fail

```
Bay 1  AUD ✓ O2 ✓  
Bump   VIS ✓ CO ✓  
Fail   H2S ✗  
OK     LEL ✓
```

If the detector failed a bump test, ✗ displays beside the applicable gas

Example: H2S✗.

If the detector fails an audible or visual test, ✗ displays beside the applicable test (**AUD** or **VIS**). For information regarding solutions, refer to [Troubleshooting](#).

Note

If a gas type fails, calibrate the detector prior to use.

Confirm that the gas concentration exceeds the low alarm set-point of the detector being tested (applicable to GasAlertClip Extreme, GasAlert Extreme, and GasAlertMicro only).

Confirm the inlets are setup correctly.

Incorrect Inlet Setup

If an inlet is not setup correctly, a hyphen (—) displays beside the gas type.

Bay 1	AUDX	SO2—
Bump	VISX	H2SX
Pass	CO—	LEL—
OK		O2 —

Example: SO₂, CO, LEL, and O₂ gases were not detected.

If a test gas fails, verify that the

- gas cylinder is not empty,
- connections are attached correctly,
- inlets are setup correctly, and
- gas concentration exceeds the low alarm setpoint (applicable to GasAlertClip Extreme, GasAlert Extreme, and GasAlertMicro only).

Sensor Disabled

⚠ Warning

To prevent personal injury and/or property damage, enable or replace the sensor immediately. Refer to the corresponding detector user manual or technical reference guide for sensor replacement procedures.

If a sensor is disabled, results from the sensor do not display on the base station LCD.— displays where the gas type typically displays on the LCD.

Bay 1	AUD√	SO2√
Bump	VIS√	—
Pass	—	—
OK		O2 √

Note

If a sensor is disabled, it is not recorded in the results log.

Calibration

Guidelines

Caution

If adjustments are made to the real-time clock, the calibration due date will be invalid for the

- **GasAlert Extreme,**
- **GasAlertMicro,**
- **GasAlertMicro 5/PID/IR,**
- **GasAlertMicroClip / GasAlertMicroClip XT,**
- **GasAlertMax XT / GasAlertMax XT II, and**
- **GasAlertQuattro detectors.**

Recalibrate the detector immediately.

When calibrating the sensors, adhere to the following guidelines:

- Recommended gas mixture:
O₂: clean air, 18% vol.
CO: (low H₂ sensitivity): 50 to 500 ppm balance N₂
CO: 50 to 500 ppm balance N₂
H₂S (high range): 10 to 100 ppm balance N₂
H₂S (low methanol): 10 to 100 ppm balance N₂
H₂S: 10 to 100 ppm balance N₂
PH₃: 1 to 5 ppm balance N₂
SO₂: 10 to 50 ppm balance N₂
NH₃: 20 to 100 ppm balance N₂
NH₃: (high range) 20 to 100 ppm balance N₂
NO₂: 5 to 50 ppm balance N₂

HCN: 5 to 20 ppm balance N₂
ETO: 5 to 50 ppm balance N₂
NO: 10 to 250 ppm balance N₂
Cl₂: 3 to 25 ppm (for bump checks only)
VOC: 100 ppm isobutylene
CO₂: 5000 ppm balance air or 0-5.0 % v/v CO₂
LEL: 10 to 100% LEL or 0.5 to 5% by vol. methane balance air

Note

The base station cannot calibrate Cl₂, O₃, and ClO₂ sensors.

- Calibrate only in a safe area and in a fresh air environment. Do not operate the base station in a hazardous area. Failure to adhere to this guideline can result in possible personal injury and/or property damage.
- BW recommends using premium grade calibration gases and cylinders that are certified to National Standards. The calibration gases must meet the accuracy of the detector.
- Do not use a gas cylinder beyond its expiration date.
- All calibration cylinders must be used with a demand flow regulator and must meet the following maximum inlet pressure specifications:
 - Disposable cylinders 0-1000 psig/70 bar
 - Refillable cylinders 0-3000 psig/207 bar
- Do not calibrate the detector during or immediately after charging is complete.
- For ETO sensors (before each work shift) allow the detector to fully stabilize in the temperature that it will be operated in, and then zero the detector.
- It is necessary to periodically re-zero the ETO sensor.

- Calibrate the sensor if the ambient gas readings vary during startup.
- Calibrate a new sensor before use. Allow the sensor to stabilize before starting calibration:
 - Used sensor: 60 seconds
 - New sensor: 5 minutes.
- Before calibrating a new NO or ETO sensor, allow the sensor to stabilize for 2 hours in a safe area that is free of hazardous gas.
- Calibrate the sensors at least once every 180 days, depending upon use and sensor exposure to poisons and contaminants. For HCN sensors, calibrate at least once every 90 days.
- Calibrate the sensor before changing the alarm setpoints.
- When calibrating multiple times, wait 10 minutes between calibrations to allow the sensor to stabilize.
- If a certified calibration is required, contact [BW Technologies by Honeywell](#).

Calibration Procedure (All models excluding the GasAlertClip Extreme)

A calibration adjusts the sensitivity level of a sensor to ensure an accurate response to gas.

⚠ Caution

Ensure the detector is not in a low battery state prior to performing a calibration.



The base station automatically accepts an unusually large span adjustment notification for the GasAlertMicro 5/PID/IR. Refer to the *GasAlert-Micro 5/PID/IR User Manual*.

The following detectors transfer event logs to the base station MMC during a calibration:

- GasAlert Extreme
- GasAlertMicroClip / GasAlertMicroClip XT
- GasAlertMax XT / GasAlertMax XT II
- GasAlertQuattro

To perform calibration, complete the following:

1. Ensure the MMC/SD card is inserted if datalogging is required.

If the MMC/SD card is not inserted,  ! displays on the LCD when the base station attempts to log the results of the calibration. If required, refer to [Inserting/Replacing a MMC/SD Card](#).
2. Activate the detector and wait until it is in normal operation. Insert it into the docking module.
3. Activate the base station and wait until it is in normal operation.
4. Press  CALIBRATION on the corresponding docking module.

Note

For calibration procedures for the GasAlertMicro 5 IR with CO₂ sensor, refer to [GasAlertMicro 5 IR with CO₂ Sensor](#).

If calibration is initiated while in the user options menu: Calibrations are initiated after exiting the user options menu.

If more than one docking module is queued: The first module queued begins the calibration.

The RUN LED flashes yellow on the remaining docking modules that are queued for calibration. When the first docking module is complete, the next module in the queue begins calibration.

The base station begins the calibration and displays the

- docking module,
- test being performed,
- detector type, and
- detector serial number.

```
Bay 1  
Calibration  
GasAlertMicro  
2346668
```

Note

The GasAlertMicro 5/PID/IR beeps and flashes two times when calibration begins. The GasAlertMicroClip / GasAlertMicroClip XT, GasAlertMax XT GasAlertMax XT II, and GasAlertQuattro beep and flash once.

⚠ Important

If the Automatic Datalog Download (GasAlertMicroClip / GasAlertMicroClip XT, GasAlertMax XT / GasAlertMax XT II, GasAlertQuattro only) is enabled in Safety Suite Device Configurator (SSDC), data transfer automatically begins during the purge. Do not remove the detector until the DATA TRANSFER PASS LED lights, otherwise the transfer will fail.

5. If there is a gas conflict or a selected gas cannot be found, refer to [Gas Conflicts](#).

6. If there are no gas conflicts, the base station then applies the gas.

```
2 O2  
000.0  
Applying Gas...
```

If more than one gas is being applied, the base station performs a purge between each gas. Depending upon the gas type, the purge time(s) will vary.

Note

*If **Automatic Datalog Download** is enabled in Safety Suite Device Configurator (SSDC), GasAlertMicroClip / GasAlertMicroClip XT, GasAlertMax XT / GasAlertMax XT II, and GasAlertQuattro automatically deactivate after the transfer is complete. To bypass the shutdown, remove the detector within 15 seconds after the DATA TRANSFER PASS LED lights.*

7. Refer to [Calibration Results](#).

GasAlertMicro 5 IR with CO₂ Sensor

Note

If calibrating a GasAlertMicro 5 IR detector, the base station automatically zeroes and then calibrates the CO₂ sensor first.

1. The base station zeroes the CO₂ sensor. The CO₂ sensor can only be zeroed using nitrogen (N₂).

Ensure N₂ has been configured to an inlet. If required, refer to [Inlet Setup](#).

- The base station applies the gas.

```
3 CO2 Zero
  000.0 PPM
  Applying Gas....
```

- The base station purges the N₂ before applying the CO₂ gas.

```
1 Purge
  020.9 %
  Applying Gas....
```

- The base station then applies the gas to the CO₂ sensor.

```
4 CO2
  5000 PPM
  Applying Gas....
```

- The base station begins calibrating the remaining sensors. For more information, refer to [Automatic Datalog Download](#).
- After calibration is complete, the base station displays the results and performs a final purge to clear any remaining gas.

```
Bay 1 AUD ✓ O2 ✓
CAL VIS ✓ CO ✓
Pass H2S ✓
Purge 022 LEL ✓
```

The countdown of seconds remaining displays beside **Purge**.

Note

After calibration, the GasAlertMicro 5/PID/IR automatically deactivates. To bypass the automatic shutdown, remove the detector within 15 seconds after the final purge begins.

Calibration Results

After the calibration is complete, the base station LCD displays the results.

✓	Pass
✗	Fail
H2S---	No gas found (H ₂ S is used as an example, this applies to all gases)
----	Sensor is disabled

Calibration Pass

```
Bay 1 AUD ✓ SO2 ✓
CAL VIS ✓ H2S ✓
Pass CO ✓ LEL ✓
OK O2 ✓
```

✓ and **Pass** indicates that the calibration has passed. The detector is now ready for use. Press **OK** to return to normal operation.

Calibration Fail

```
Bay 1 AUD ✓ SO2 ✓  
CAL VIS ✓ H2S ✗  
Fail CO ✓ LEL ✓  
OK O2 ✓
```

If calibration fails, ✗ displays beside the applicable gas.

Example: H2S ✗

Incorrect Inlet Setup

If an inlet is not setup correctly during a calibration, the base station displays **Fail** and a hyphen (—) beside the gas type.

```
Bay 1 AUD ✓ SO2 ✓  
CAL VIS ✓ H2S —  
Fail CO — LEL —  
OK O2 ✓
```

Example: H₂S, CO, and LEL gases were not detected.

If a test gas fails, verify that the

- gas cylinder is not empty,
- connections are attached correctly, and
- inlets are setup correctly.

If the detector fails an audible or visual test, ✗ displays beside the applicable test (**AUD** or **VIS**). For information regarding solutions, refer to [Troubleshooting](#).

Sensor Disabled

⚠ Warning

To prevent personal injury and/or property damage, enable or replace the sensor immediately. Refer to the corresponding detector user manual for sensor replacement procedures.

If a sensor is disabled, results from the sensor do not display on the base station LCD. — displays where the gas type typically displays on the LCD.

```
Bay 1 AUD ✓ SO2 ✓  
CAL VIS ✓ —  
Pass — —  
OK O2 ✓
```

Note

If a sensor is disabled, it will not be recorded in the results log.

Data Transfer

(GasAlert Extreme, GasAlertMicroClip / GasAlertMicroClip XT, GasAlertMax XT / GasAlertMax XT II, and GasAlertQuattro only)

Transferring Datalogs

The data transfer function transfers datalogs from the detector to the base station's MMC/SD card. The data can then be imported into Safety Suite Device Configurator (SSDC).

Depending upon how many logs are stored on the MMC, the data transfer may require several minutes to complete (1-2 minutes for GasAlertMicroClip / GasAlertMicroClip XT and GasAlertMax XT / GasAlertMax XT II).

To transfer datalogs from the detector to the docking module and then to the base station MMC/SD card, complete the following:

1. Activate the detector and wait until it is in normal operation. Insert it into the docking module.
2. Activate the base station and wait until it is in normal operation.
3. Press  DATA TRANSFER on the docking module. The yellow RUN LED flashes rapidly and the docking module transfers the datalog to the base station.

When the transfer process is complete, the docking module indicates the status of the transfer as PASS or FAIL.

Successful Transfer: If the datalog transfer is successful, the PASS LED lights green, the RUN LED flashes yellow slowly, and the detector beeps.

Unsuccessful Transfer: If the datalog transfer is unsuccessful, the FAIL LED lights red and the RUN LED flashes slowly.

If a failure occurs during the transfer of a datalog, typically some of the data transfers to the MMC/SD card. To determine if any data has been transferred, access the MMC data using Safety Suite Device Configurator (SSDC). Refer to the SSDC Operator's Manual.

If required, repeat step #3 to transfer the datalog.

4. After a successful transfer to the base station, the base station transfers the datalog to the MMC/SD card. The RUN and the PASS LEDs light on the docking module and the following screen displays on the base station LCD.

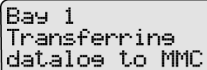

```
Bay 1  
Transferring  
datalog to MMC
```

When the datalog has successfully transferred from the base station to the MMC/SD card, the following screen displays on the base station LCD.

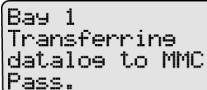

```
Bay 1  
Transferring  
datalog to MMC  
Pass.
```

5. On the base station, press Pass to return to the normal operating screen.

Maximum Datalog Storage Capacity

When the maximum datalog storage is reached, the base station replaces the oldest datalogs with the newest datalogs. Datalogs are not recorded in the [Results History](#).

Automatic Datalog Download

(GasAlertMicroClip / GasAlertMicroClip XT, GasAlertMax XT / GasAlertMax XT II, and GasAlertQuattro only)

The detector can be configured to automatically transfer datalogs every time a bump test or calibration is performed.

Using the IR Link

- To configure the GasAlertMicroClip / GasAlertMicroClip XT using the IR Link and Safety Suite Device Configurator (SSDC), refer to the *GasAlertMicroClip User Manual* or *GasAlertMicroClip XT Technical*.
- To configure the GasAlertMax XT / GasAlertMax XT II using the IR Link and Safety Suite Device Configurator (SSDC), refer to the *GasAlertMax XT II Technical Reference Guide*.
- To configure the GasAlertQuattro using the IR Link and Safety Suite Device Configurator (SSDC), refer to the *GasAlertQuattro Technical Reference Guide*.

Using the MicroDock II

To enable Automatic Datalog Download using MicroDock II and Safety Suite Device Configurator (SSDC), complete the following:

1. From the PC, open SSDC.
2. Under the Device list view tab, click on the checkbox next to the MicroDock II device.
3. At the top right corner click on . The dropdown configuration menu displays.

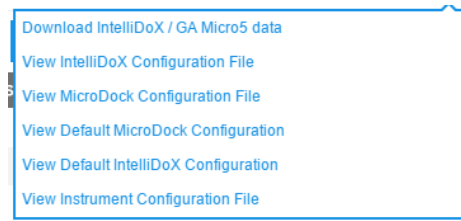

Figure 23. Load Configuration File

4. Click on View Default MicroDock Configuration to see the available devices.
5. Select which device to configure by clicking its tab.
6. Under **Other Test Options** check the box for **Automatic Datalog Download**.

7. Under program options, select an option to reprogram the detector.
 - **Reprogram with user's consent (but do not change Date/Time):** When selected, the base station asks if the detector will be reconfigured each time a bump check or calibration is initiated. The detector's clock is not changed to match the MicroDock II's clock.
 - **Automatically reprogram (but do not change Date/ Time):** When selected, the detector is automatically reconfigured when a bump test or calibration is initiated. The detector's clock is not changed to match the Micro-Dock II's clock.
 - **Reprogram with user's consent (including Date/ Time):** When selected, the base station asks if the detector will be reconfigured each time a bump check or calibration is initiated. The detector's clock will be changed to match the MicroDock II's clock.
 - **Automatically reprogram (including Date/Time):** When selected, the detector is automatically reconfigured when a bump test or calibration is initiated. The detector's clock is changed to match the MicroDock II's clock.

8. Ensure the base station is connected to the computer using a USB cable.
9. Click **Save to Dock** in the lower right-hand corner.
10. The Device List configuration displays.

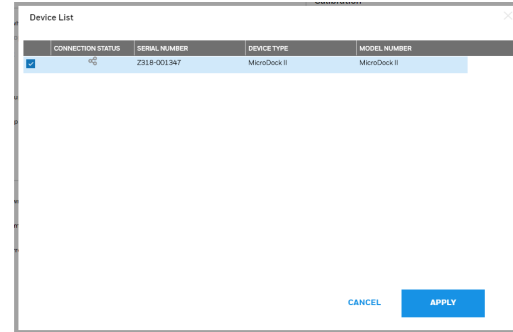
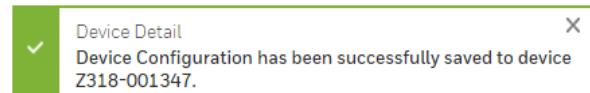

Figure 24. Device List Dialog Box

11. Select the checkbox to select a MicroDock II to save to and click on **Apply**.
12. A dialog box displays the message **Successfully saved to Device**.



13. Refer to [Reconfiguring the Detector \(not applicable to the GasAlertClip Extreme\)](#) to download the new configuration to the detector

Base Station MMC/SD Card

Event Logging

Bump tests and calibrations are recorded on a MultiMediaCard (MMC) or a Secure Digital (SD) card. The MMC/SD card is located in the base station inside the battery compartment. It stores test records that are then downloaded from the base station to a PC.

The following detectors transfer event logs to the base station MMC during a bump test or calibration:

- GasAlertClip Extreme (bump test only)
- GasAlert Extreme
- GasAlertMicroClip / GasAlertMicroClip XT
- GasAlertMax XT / GasAlertMax XT II
- GasAlertQuattro

Inserting/Replacing a MMC/SD Card

The MMC/SD card is inserted in the base station inside the battery compartment. To insert or replace the MMC/SD card, refer to Figure 26. and complete the following procedures:

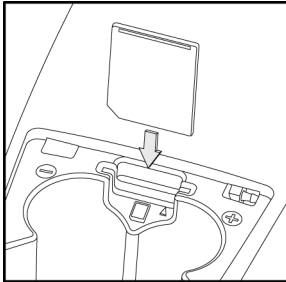

Figure 26. Replacing a MMC/SD Card

1. Deactivate the base station.
2. Loosen the retaining screws from the battery cover. Do not remove the screws from the battery cover.
3. Remove the battery cover and set it aside.
4. Remove the current MMC/SD card (if applicable).
5. Insert the new MMC/SD card into the memory card slot.
6. Replace the battery cover and tighten the retaining screws. Do not overtighten the screws

To format an MMC/SD card, refer to [Formatting the MMC/SD Card](#) in the [User Options Menu](#) section.

Accessing Test Results

To access and view test results using Safety Suite Device Configurator (SSDC), refer to the *SSDC Operator's Manual*.

Data that is saved on the MMC/SD card can be transferred to a PC. MicroDock II test results are saved in the .CSV format.

The following version of the Microsoft Windows operating system supports Safety Suite Device Configurator (SSDC):

- Windows 10 64-bit version 1809 or above

System requirements

Windows 10 System Requirements

- Intel® Wireless Bluetooth® Driver: 21.60.0 or above
- Microsoft® .NET Framework V4.6.1 or above (can be installed with Honeywell Safety Suite Device Configurator installation)
- Windows 8 not supported.
- Administrator privileges on Windows account.

The computer must also have the following software:

- A PDF reader

Note

BW recommends that bump tests and calibrations be completed before accessing results on the PC.

Charging the Detector

(Excluding GasAlert Extreme and GasAlertClip Extreme)

Warning

A maximum of six charging docking modules can be installed on the base station.

To charge successfully, the temperature must be between 50°F to 95°F (10°C to 35°C). Charge the battery when the detector emits a low battery alarm.

Caution

The charger is for indoor use only.

Do not calibrate or bump the detector immediately after charging is complete.

When charging for the first time, refer to the detector's user manual or technical reference guide.

Note

The detector will not charge while bump tests or calibrations are being performed. If the battery is low, charge the detector for 30 minutes then begin a test. When the test is complete resume charging the battery.

Charger/Battery Pack Guidelines

- Deactivate the detector before charging.
- When charging is complete, the detector can remain in the detector bay without wear or damage to the battery.
- Charging the battery pack in temperatures above 86°F (30°C) greatly reduces the number of possible charges to the battery pack.
- When charging is complete, the battery pack may be warm.
- The battery pack requires approximately three charge cycles to achieve full charge capacity.
- The base station only charges using DC power.
- Charging more than four units simultaneously increases the total charge time.
- Up to six GasAlertMicro and GasAlertMicro 5/PID/IR detectors can charge simultaneously.
- Up to four GasAlertMicroClip / GasAlertMicroClip XT, GasAlertMax XT / GasAlertMax XT II, and GasAlertQuattro can charge simultaneously.
- When charging an extremely depleted battery, the battery requires a longer charging time.
- The detector cannot charge during bump tests or calibrations. If battery power is low, charge the detector for 30 minutes and then initiate the bump/calibration.
- When a fully charged battery is inserted into the detector bay, the charger LED lights red for 6 to 10 minutes before lighting green. This action will not wear or damage the battery.

Charging Different Detectors Together

Up to six charging docking modules can be attached to the base station.

If charging GasAlertMicroClip / GasAlertMicroClip XT, GasAlertMax XT / GasAlertMax XT II, or GasAlertQuattro with GasAlertMicro 5/PID/IR or GasAlertMicro, refer to the following:

- If another GasAlertMicroClip / GasAlertMicroClip XT, GasAlertMax XT / GasAlertMax XT II, or GasAlertQuattro is added, the added detector will wait in queue until a GasAlertMicro 5/PID/IR or GasAlertMicro has completed charging before beginning to charge.
- If another GasAlertMicro 5/PID/IR or GasAlertMicro is added, the added detector will begin charging and one GasAlertMicroClip / GasAlertMicroClip XT, GasAlertMax XT / GasAlertMax XT II, or GasAlertQuattro will stop charging. The GasAlertMicroClip / GasAlertMicroClip XT, GasAlertMax XT / GasAlertMax XT II, or GasAlertQuattro will begin charging when a GasAlertMicro 5/PID/IR or GasAlertMicro has completed charging.

Charging Procedure

Table 21. Charger Status LED

Charger Status	Description
Red	Charging normally
Flashing red	Detector waiting in queue to charge
Green	Charge complete
Off	Charge or temperature fault

The battery pack for the GasAlertMicro 5/PID/IR and GasAlertQuattro can be charged separately from the detector. Refer to [Inserting the GasAlertMicro 5/PID/IR Battery Pack](#) or [Inserting the GasAlertQuattro Battery Pack](#).

To charge a detector or battery pack in a charging docking module, complete the following:

1. Connect the AC adapter of the charger to the CHARGE port on the base station and then plug the cord into the AC outlet. The CHARGE STATUS LED briefly lights red then green during the self-test. The LED then deactivates.
2. If charging the detector, deactivate the detector and insert it into the detector bay.

If charging the battery pack, remove the battery pack from the detector. Insert it into the detector bay bottom first.
3. The charging LED then lights red.

Ensure the detector is inserted correctly onto the contact pins.
4. The CHARGE LED lights red.
5. Allow the battery to obtain a full charge (2 to 6 hours, depending upon detector type and number of docking modules connected to the base station).

If a docking module is in queue waiting to be charged, the CHARGE LED flashes red (all charging modules). If there is not an AC adapter plugged into the CHARGE port, the GasAlertMicroClip / GasAlertMicroClip XT and GasAlertMax XT / GasAlertMax XT II modules' CHARGE LED flashes red.

When the docking module begins charging, the CHARGE LED stops flashing and lights solid red.

The CHARGE LED lights green when the charging process is complete. If there are other docking modules in queue waiting to charge, the docking modules will begin charging.

The CHARGE LED deactivates when the detector is removed.

Maintenance

⚠ Warning

No user-serviceable parts inside.

To maintain the base station in good operating condition, perform the following basic maintenance as required.

- To ensure quality product operation, maintain a log of all maintenance that is performed.
- Clean the exterior with a soft, damp cloth. Do not use solvents, soaps, or polishes.
- Confirm that the inlet filter is free of dirt and replace it if required. To order replacement parts, refer to [Replacement Parts and Accessories](#).
- Do not immerse the base station in liquids.

Battery Pack Storage

GasAlertMicro and GasAlertMicro 5/PID/IR

When storing for extended periods of time, ensure that the detector is fully charged and recharged every 30 days.

GasAlertMicroClip / GasAlertMicroClip XT

If the GasAlertMicroClip / GasAlertMicroClip XT will be stored for an extended period of time, ensure the detector is fully charged before storage and then recharged every 30 days. Calibration due dates may be lost if the detector is not recharged every 30 days.

Troubleshooting

If a problem is encountered, refer to the solutions provided in the following table. If the problem cannot be resolved, contact [BW Technologies by Honeywell](#).

Table 22. Troubleshooting Tips

Problem	Possible Cause	Solution
The base station does not activate.	There is no power connection.	Connect the power adapter.
	Batteries are not inserted.	Insert the batteries.
	The batteries are depleted.	Replace the batteries.
	The base station is damaged or defective.	Contact BW Technologies by Honeywell .
The detector fails a bump test.	Barbed fittings are not connected correctly with the gasket.	Confirm connection. Refer to Adding Another Docking Module .
	Detector alarm setpoints are set higher than the gas concentration levels of the gas cylinder.	Connect a gas cylinder that has a higher gas concentration level than the alarm setpoints.
	Gas connections are not attached correctly or are blocked.	Confirm that all gas connections are attached correctly.
	Gas inlets are not setup correctly.	Refer to Inlet Setup and Installation .
	Gas cylinder is empty.	Use a new gas cylinder.
	Detector and/or base station are damaged or defective.	Contact BW Technologies by Honeywell .

Problem	Possible Cause	Solution
The oxygen sensor fails a bump test.	Oxygen alarm setpoints of the detector are set to the same concentration level as the gas cylinder.	Connect a quad-gas cylinder that has 18% O ₂ .
	Ambient air (inlet 1) is blocked or the inlet filter is contaminated.	Remove the blockage or replace the inlet filter.
	Zero gas cylinder is empty.	Use a new zero gas cylinder.
The detector fails a calibration.	Gas cylinder is empty.	Use a new gas cylinder.
	Barbed fittings are not connected correctly to the gasket.	Confirm connection. Refer to Adding Another Docking Module .
	Gas connections are not attached correctly or are blocked.	Confirm that all gas connections are attached correctly.
	Detector and/or base station are damaged or defective.	Contact BW Technologies by Honeywell .
Flashing battery icon  .	Batteries are extremely depleted.	Replace the batteries.
The base station is activated but does not respond to button presses.	Irregular power (not continuous or reliable) electrostatic discharge.	Deactivate the base station, wait 5 seconds, then reactivate.
There is no audible beep (GasAlertMicro and GasAlertMicro 5/PID/IR).	Internal damage to battery or docking module.	Contact BW Technologies by Honeywell .

Problem	Possible Cause	Solution
<p>The docking module does not recognize the detector.</p>	<p>Detector is deactivated.</p>	<p>Activate the detector.</p>
	<p>Detector does not have IR communication capabilities.</p>	<p>Refer to the label located on the back of the detector for IR capabilities.</p>
	<p>Firmware of the detector requires an update.</p>	<p>Contact BW Technologies by Honeywell.</p>
	<p>Base station is currently attempting to establish communication with the detector.</p>	<p>Wait approximately 30 seconds.</p>
	<p>Docking module is not initialized to the correct number.</p>	<p>Re-initialize the docking module. Refer to Adding Another Docking Module.</p>
	<p>Detector and/or base station are damaged or defective.</p>	<p>Contact BW Technologies by Honeywell.</p>
<p>There is an audible beep but no charge (GasAlertMicro and GasAlertMicro 5/PID/IR docking modules).</p>	<p>Battery is above or below the operating temperature 50°F–95°F (10°C–35°C).</p>	<p>Allow the battery pack time to adjust to the specified operating temperature (approximately 60 minutes).</p>
	<p>Severely depleted battery.</p>	<p>Charge (2–4 hours) or replace old battery with new battery. If problem persists, contact BW Technologies by Honeywell.</p>
	<p>Damaged or defective battery pack.</p>	<p>Contact BW Technologies by Honeywell.</p>

Problem	Possible Cause	Solution
The charger LED does not light when the detector or battery pack is inserted (for GasAlertMicro, GasAlertMicro 5/PID/IR, GasAlertMicroClip / GasAlertMicroClip XT and GasAlertQuattro docking modules). Charging the battery pack separately from the detector is only applicable to GasAlert-Micro 5/PID/IR and GasAlertQuattro	Detector or battery pack is not inserted into the detector bay correctly.	Firmly insert the detector into the detector docking bay.
	The battery pack is above or below the operating temperature 50°F–95°F (10°C–35°C).	Allow the battery pack time to adjust to the specified operating temperature (approximately 60 minutes).
	The battery pack is severely depleted.	Allow the detector to charge (2–4 hours).
The charger LED on the GasAlertMax XT / GasAlertMax XT II docking module lights solid for 15 minutes and then deactivates. This behavior may also occur while waiting in queue to charge.	Detector or battery pack is not inserted into the detector bay correctly.	Firmly insert the detector or battery pack into the detector docking bay.
	The battery pack is severely depleted	Remove and insert the detector or battery pack several times to restore charge capability.

Problem	Possible Cause	Solution
No drive letter is created for the MicroDock II (Windows XP) on the PC.	Windows XP is not correctly mapping the drive.	Ensure Windows XP has assigned a drive letter to the MicroDock II. Solution: 1) Right-click My Computer and then click Manage . 2) Under Computer Management (Local) click Disk Management . 3) In the list of drives in the right pane, right-click the new drive and then click Change Drive Letter and Path(s) . 4) Click Change and in the drop-down box, select a drive letter for the new drive (cannot be assigned to a mapped network drive). 5) Click OK and then click OK again.

Problem	Possible Cause	Solution
<p>Autoplay displays after every bump test and calibration.</p>	<p>Autoplay is enabled</p>	<p>Disable Autoplay. Windows XP: 1) Click Start Menu, then Run. 2) Enter gpedit.msc 3) The Group Policy window displays. 4) Click Administrative Templates and then System. 5) In the right-hand pane, double-click on Turn off Autoplay. 6) The Turn off Autoplay Properties dialog box displays. 7) Select Enabled. 8) From the Turn off Autoplay on drop down men, select All drives. Then click OK.</p> <p>Windows Vista: 1) Open Control Panel. 2) Under Hardware and Sound, click Play CDs or other media automatically. 3) Then remove the check from the Use AutoPlay for all media and devices checkbox.</p>
	<p>Problem transferring to the MMC/SD card during a calibration or bump test.</p>	<p>Repeat the test.</p> <hr/> <p>Ensure the MMC/SD card is inserted.</p>

Problem	Possible Cause	Solution
<pre>MMC Size Is Not Supported OK</pre>	Size of MMC is not supported.	Insert a 128 MB Delkin MMC.
<pre>Error Formatting MMC Please Try Another Card OK</pre>	MMC is not correctly formatted.	Refer to Formatting the MMC/SD Card . Replace with a new MMC/SD card.
<pre>MMC Is Full OK</pre>	Log file has exceeded maximum size.	Refer to Formatting the MMC/SD Card . Replace with a new MMC/SD card.
<pre>Bay 1 IR Communication Not Working OK</pre>	IR not working when detector is inserted into the module.	Check for dirt on the IR port. Confirm the detector is activated. Charge the detector battery if too low.
<pre>Bay 1 Detector Not Supported OK</pre>	Non-datalogger detector is inserted in the docking module.	Insert only datalogger models.
<pre>Bay 1 Err. C02 17 OK</pre>	Software exception.	If an error code displays on the LCD, record it and contact BW Technologies by Honeywell .

Replacement Parts and Accessories

⚠ Warning

To avoid personal injury or damage to the base station, use only the specified replacement parts.

To order parts or accessories, contact [BW Technologies by Honeywell](#).

Table 23. Replacement Parts and Accessories

Model Number	Description
GasAlertMicro Docking Module	
DOCK2-0-1A-00-N	Non-charging
DOCK2-0-1B1C-00-N	Charging (power supply included)
GasAlertMicro 5/PID/IR Docking Module	
DOCK2-0-1J-00-N	Non-charging
DOCK2-0-1C1K-00-N	Charging (power supply included)
GasAlert Extreme Docking Module	
DOCK2-0-1D-00-N	With datalogging
GasAlertClip Extreme Docking Module	
DOCK2-0-1E-00-N	H ₂ S (hydrogen sulfide)
DOCK2-0-1H-00-N	O ₂ (oxygen)
DOCK2-0-1G-00-N	CO (carbon monoxide)
DOCK2-0-1F-00-N	SO ₂ (sulfur dioxide)
GasAlertMicroClip Docking Module	
DOCK2-0-1C1L-00-N	Charging (power supply included)
GasAlertMicroClip XT Docking Module	
DOCK2-2-1C1P-00-G	Charging (power supply included)

Model Number	Description
GasAlertMax XT / GasAlertMax XT II Docking Module	
DOCK2-0-1C1M-00	Charging (power supply included)
GasAlertQuattro Docking Module	
DOCK2-0-1C1N-00-N	Charging (power supply included)
MMC/SD Communication Devices and Accessories	
CR-MMC-USB1	MMC USB Reader (USB port) for MMC
DOCK2-LAN1	Network USB communication device
DOCK2-MMC	Delkin 128 MB MultiMediaCard (MMC)
Wall Mount Adapters	
WMA-DOCK	For MicroDock II and charging modules (kit of 2)
MK-CG2-34B	For 34 l gas cylinder (black)
MK-CG2-58	For 58 l gas cylinder (red)
Replacement Parts and Accessories	
DOCK2-DA-1	Diffusion adapter
Carrying Cases	
DOCK2-CC1	Hard-sided (1 module system)
DOCK2-CC2	Heavy duty (1 to 3 module system)
Demand Flow Regulators	
REG-DF-1	Demand flow regulator
REG-DF-2	For refillable cylinders CGA connector

Specifications

The MicroDock II is for indoor use only.

UKCA

Instrument dimensions: 21.2 x 26.3 x 8.2 cm

(8.3 x 10.4 x 3.2 in.) base station and one docking module

Weight: 0.98 kg (2.15 lb)

Base system ingress protection: IP20

Enclosure: Impact resistant PC/ABS (polycarbonate)

Operating temperature: +10°C to +35°C (+50°F to +95°F)

Humidity: 0 to 50%

Altitude: 2000 m (6561.66 ft.)

Storage temperature: -10°C to 60°C (14°F to 140 °F)

Power supply: 6 Vdc, 1.5 A wall adapter or four C-cell batteries (main supply voltage fluctuations are not to exceed 10% of the nominal supply)

Pollution degree: 2

Installation category: I

Real-time clock: Provides time and date stamp

Data storage: Automatic (instrument and base station)

128 MB Delkin MMC data storage system

External interface: USB interface for PC

Pump: DC motor, micro-diaphragm; 3V PCB mount

Flow rate: Maximum recommended 350 ml/min.

Calibration gas cylinder inputs:

2-gas inlets (standard)

4-gas + air inlets (maximum)

Automatic tests: Functional bump test, calibration, data transfer, audible alarm, visual alarm

Configuration recognition: Automatic (instrument and sensor)

Alarm/calibration parameters: User-defined

Calibration gas connections: Built-in (base station)

Gas connection: 1/8" SMC connect sub-miniature coupling

Solenoid: Built-in (docking modules)

LED indicators: (on each docking module)

Yellow – Test

Green – Pass

Red – Fail

Command keys:

Base station	Menu navigation
Docking module	One touch bump test initiation One touch calibration initiation (not applicable to the GasAlertClip Extreme) One touch data transfer initiation (GasAlert Extreme, GasAlertMicroClip / GasAlertMicroClip XT, and GasAlertMax XT / GasAlertMax XT II only)

Communications method: Infrared (two-way) between docking module and detector (not applicable to the GasAlertClip Extreme – one way communication only)

USB port for connection to a:

Personal computer (PC), or
 USB over IP HUB

Sensors: Audio
 Optical

LCD: 4 line x 16 characters, wide viewing angle, user-defined backlighting

Warranty: 2 years

Charger Specifications

Size: 8.6 x 8.2 x 7.8 cm (3.4 x 3.2 x 3.1 in.)

Weight: 97 g (3.4 oz)

Charger system ingress protection: IP20

Operating temperature: 10°C to 35°C (50°F to 95°F)

Humidity: 0% to 50%

Altitude: 2000 m (6561.66 ft.)

Power: 6 VDC , 2.5 A

Charging LED: Color-coded LED advises: charging, charge complete, and charger fault

Charge time: Typically 2-6 hours

Pollution degree: 2

Installation category: I

This device complies with the FCC Part 15 and ICES-003 Canadian EMI requirements. Operation is subject to the following two conditions:

- This device may not cause harmful interference, and
- This device must accept any interference received, including interference that may cause undesired operation.

This equipment has been tested and found to comply with the limits for a Class A digital device, pursuant to Part 15 of the FCC Rules and ICES-003 Canadian EMI requirements.

These limits are designed to provide reasonable protection against harmful interference when the equipment is operated in a commercial environment.

This equipment generates, uses, and can radiate radio frequency energy, and if not installed and used in accordance with the instruction manual, may cause harmful interference to radio communications.

Operation of this equipment in a residential area is likely to cause harmful interference in which case the user will be required to correct the interference at his/her own expense.

Warning

This product is designed for installation in an indoor location only. All required National Electrical Codes and Safety Standards must be followed.

For AC main operation, the method to disconnect power is to unplug the power cord from the outlet. A locking device may not be used on the power cord plug.

Warning

This instrument contains a lithium polymer battery. Dispose of lithium cells immediately. Do not disassemble and do not dispose of in fire. Do not mix with the solid waste stream. Spent batteries should be disposed of by a qualified recycler or hazardous materials handler

Wear yellow. Work safe.

135296-L3 EN-P

[English]

© BW Technologies 2023. All rights reserved.