

SPM Flex® Single Point Monitor Gas Detector Quick Start Guide



Warnings and cautions

⚠️ WARNING

- Operate and service the SPM Flex gas detector only as specified in this quick start guide and the accompanying manual. Failure to do so may impair the protection provided by the detector and may also void the warranty.
- The battery is not field-replaceable. Return the unit to Honeywell Analytics if a battery replacement is necessary.
- Risk of fire and burns. Do not open, crush, heat above 140°F (60°C), or incinerate. Follow manufacturer's instructions.
- Protection afforded by the SPM Flex gas detector may be impaired if it is not used according to the manufacturer's instructions.
- Do not operate two-way radios near the detector.
- Calibration, set-up, and test modes are intended for use by trained personnel or service engineers only. Access to these modes can be passcode protected.
- Follow local and site procedures when working with the SPM Flex gas detector. If needed, ensure that the associated control panel is inhibited in order to prevent false alarms. The following procedures must be followed carefully and performed only by suitably trained personnel.
- Use only accessories and parts meeting or exceeding Honeywell Analytics' specifications.

⚠️ CAUTION

- The SPM Flex detector must be installed only by qualified professional personnel in accordance with local codes.
- The safety of any system incorporating the SPM Flex gas detector is the responsibility of the assembler of the system.
- Position a permanently-installed SPM Flex gas detector so that it does not interfere with access to the dedicated circuit breaker.
- Use the supplied power adaptor/connector only. (The adaptor is rated for indoor use only.)
- Do not leave the optics gate open. Doing so may allow pressurized gases to escape through the tubing into the unit and then into the local environment.

Unpacking the box

The contents of the box:

- the SPM Flex gas detector
- the handle assembly (for portable models only)
- power adaptor and cable
- shoulder strap (for portable models only)
- mounting bracket (for fixed units only)
- a CD containing the Technical Manual
- this Quick Start Guide

Save the packaging to re-use for service requests.

External connections

The detector is supplied with weather-sealed connectors for power, Ethernet, and communications (for relays or 4-20 mA). See the SPM Flex manual if the detector is being mounted in a fixed location.

Portable detectors must be charged at least four hours. (They can be used while charging.) Honeywell Analytics recommends leaving the detector connected to the power source/charger when not in use to keep the battery fully charged.

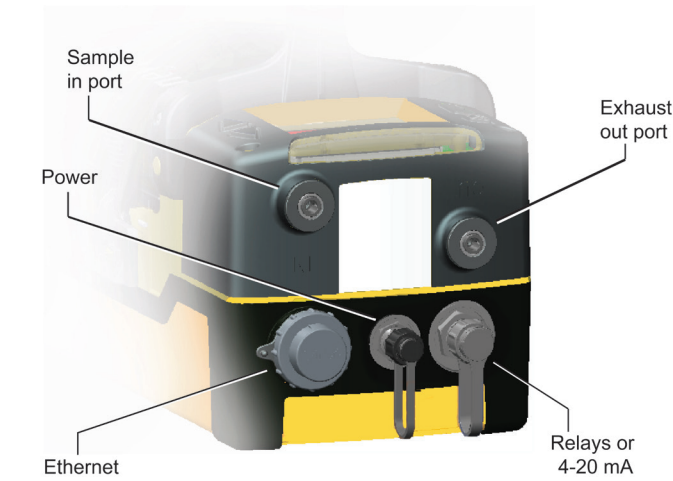

Figure 1: terminals and ports

Turning the detector on and off

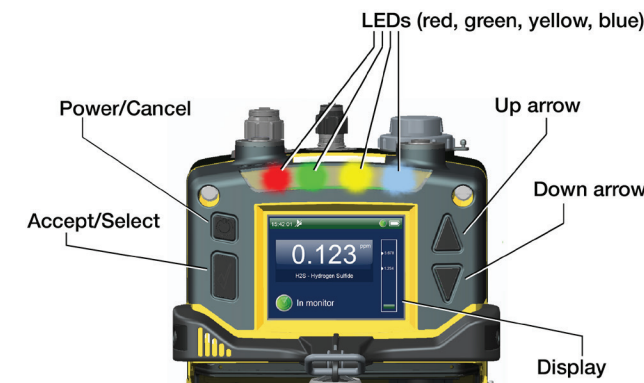

Figure 2: SPM Flex buttons and color LCD display

1. Verify that the rocker switch under the cover is in the on position. (Typically, it is switched off only for transport or service.) Do not power up the detector with a flash drive attached.
2. Press and hold the Power/Cancel button until the green LED begins blinking. The detector will then complete the start-up sequence.
3. To turn the detector off, press and hold the Power/Cancel button for 5 seconds or select "Power Off" from the menu.

Navigation

All SPM Flex menus are navigated by the four buttons shown in Figure 2. Pressing either of the arrows or the Accept/Select button will access the menu from the main display screen. The arrows are used to scroll up and down through lists of options. The Accept/Select button is used to initiate a highlighted option. During navigation, the Power/Cancel button will cancel a command or, when pressed for more than 3 seconds, it will exit to the main display.

The display

Figure 3 shows the common elements of the display.

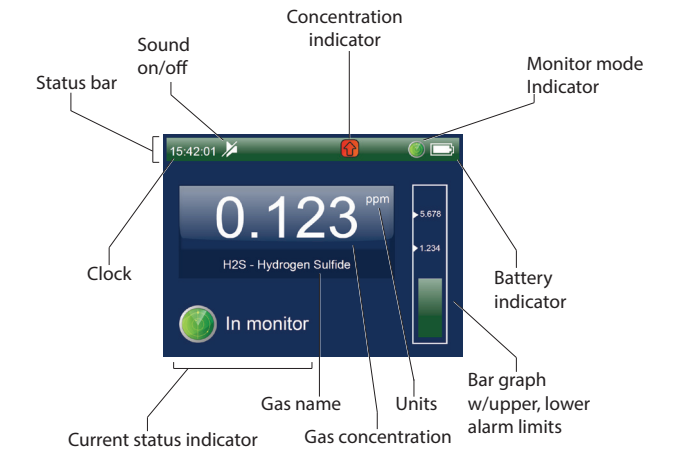

Figure 3: SPM Flex display - In Monitor mode

In the status bar, the color of the status bar changes according to the conditions (blue = out of Monitor mode, green = status OK, yellow = fault, red = alarm).

See Figure 10 (over) for the detector's menu map.

The interface consists of a color LCD, a 4-button keypad, and four color status LEDs. The menu options are navigated using these buttons:

Interface Button	Function
Up arrow	Scroll up through lists of options
Down arrow	Scroll down through lists of options
Accept/Select	Accept a highlighted option
Power/Cancel	Cancel

The four LEDs provide at-a-glance information about the current state of the detector:

LED	Description	
Red	solid blinking	Alarm 1 Alarm 2
Green	blinking	The detector is active
Yellow	solid blinking	Maintenance fault Instrument fault
Blue	solid	Connected to external power

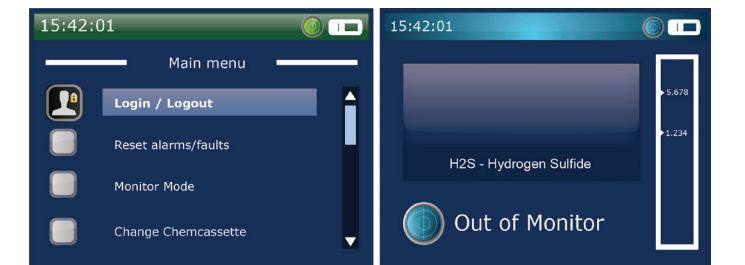

Figure 4: Main menu

Figure 5: Out of monitor mode

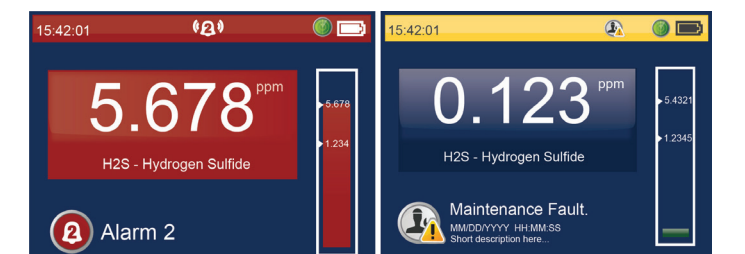

Figure 6: Alarm mode

Figure 7: Maintenance fault

Opening the Chemcassette® cartridge door



Figure 8: Opening the Chemcassette cartridge door

Loading a Chemcassette® cartridge

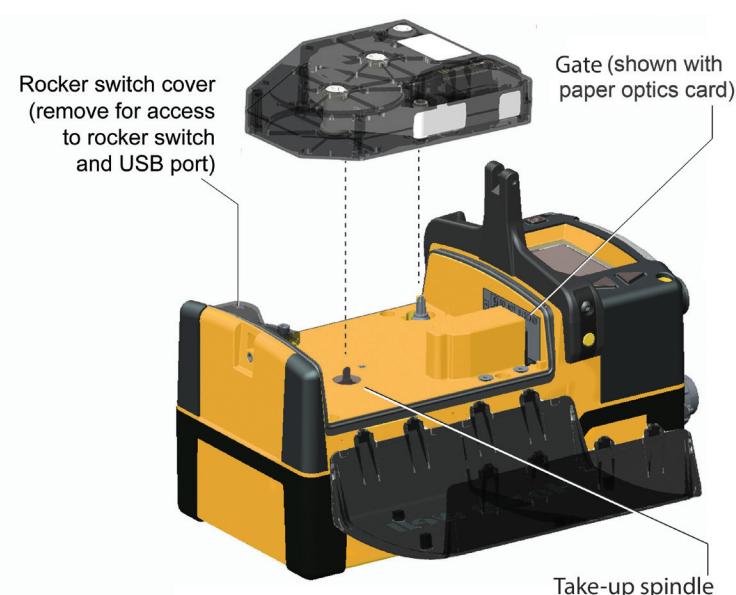

Figure 9: Loading a Chemcassette cartridge

1. Navigate to the “Change Chemcassette” menu option.
2. Follow the on-screen instructions to install or change the cartridge.
3. Remove the paper optics card from the gate.
4. Insert the Chemcassette cartridge in the detector (it will fit in only one orientation). The take-up spindle will rotate slightly to allow the cartridge to snap into place easily.
5. Close the cover.
6. A summary of the current configuration will be displayed. Select either to enter monitor mode or to remain out of monitor mode (i.e., idle).

Removing a Chemcassette® cartridge

1. Navigate to Maintenance > Open/Close gate.
2. Select “Open Gate.”
3. Remove the cartridge.
4. Insert the optics card in the gate if the detector will be stored or transported.
5. Select “Close Gate.”

Changing the selected gas

1. While out of monitor mode, navigate to Set-up > Monitoring > Gas.
2. Select “Current gas” and pick the desired gas from the selection box.
3. Select “Save.”

Entering monitor mode

From the main menu, navigate to the “Monitor Mode” option and select “Enter monitor mode.”

1. If a Chemcassette cartridge has been installed, the detector will enter Monitor Mode.
2. If a Chemcassette cartridge has not been installed, a user with the necessary passcode can initiate the Chemcassette wizard. Otherwise, the detector will not enter monitor mode.

Wiring and tubing

The SPM Flex detector has flexible installation options to allow the user to select the one most suitable for a specific application. The 4-20 mA output is a three-wire connection that is configurable as sink, source, or isolated. The detector is equipped with three relays.

Sample Tubing Specifications					
Description		Maximum			
Inlet	Tubing length, ft. (m)	100 (30)	66 (20)	33 (10)	0
	Transport time (sec)	19	13	7	1
	Flow rate (cc/min.)	700-1200 (flow is set and controlled per calibration)			
	Tubing OD, in. (mm)	0.25 (6.35)			
	Tubing ID, in. (mm)	0.125 (3.18)			
Outlet	Tubing length, ft. (m)	100 (30)			
	Tubing OD, in. (mm)	0.25 (6.35)			
	Tubing ID, in. (mm)	0.188 (4.76)			

The overall maximum load on the pump between the inlet and the exhaust should not exceed 10 inches H₂O.

NOTE

Use Teflon Fluorinated Ethylene Polymer (FEP) tubing to ensure proper sample transport.

The SPM Flex detector is supplied with the standard Ethernet, power, and communications connectors installed. The Ethernet connector can be removed and provides a 1-inch conduit port which allows a direct connection to the PCB communication terminals. Refer to the *Wiring and tubing* section of the user manual for more information.

Attaching the shoulder strap

If the shoulder strap is to be used with a portable detector, attach its spring clips to each of the rings on the detector’s handle.

Product label

Honeywell Analytics, Inc.
 405 Barclay Blvd
 Lincolnshire, IL 60069 USA
 tel: +1 847 955 8200
 e-mail: ha.us.service@honeywell.com
 Made in Korea / Fabriqué en Corée



126505000A21140033

SPM Flex Gas Detector
 P/N: 1265-0500 Rev. 0A
 Input Voltage: 24VDC 4.0A

FCC ID: 2ACSZSPMFLEX IC: 12190A-SPMFLEX

CAUTION Certified to reduce risk of electric shocks and electrical fire hazards only. Warning - Equipment must be isolated or disconnected from voltage supply before servicing.
 La certification couvre uniquement les risques de chocs électriques et d'incendies d'origine électrique. Attention - Cet équipement doit être isolé ou déconnecté de l'alimentation avant d'y faire des tâches de maintenance.

Patents: US7224285, US7504959

CE 0984

Figure 11. SPM Flex label

Menu Map

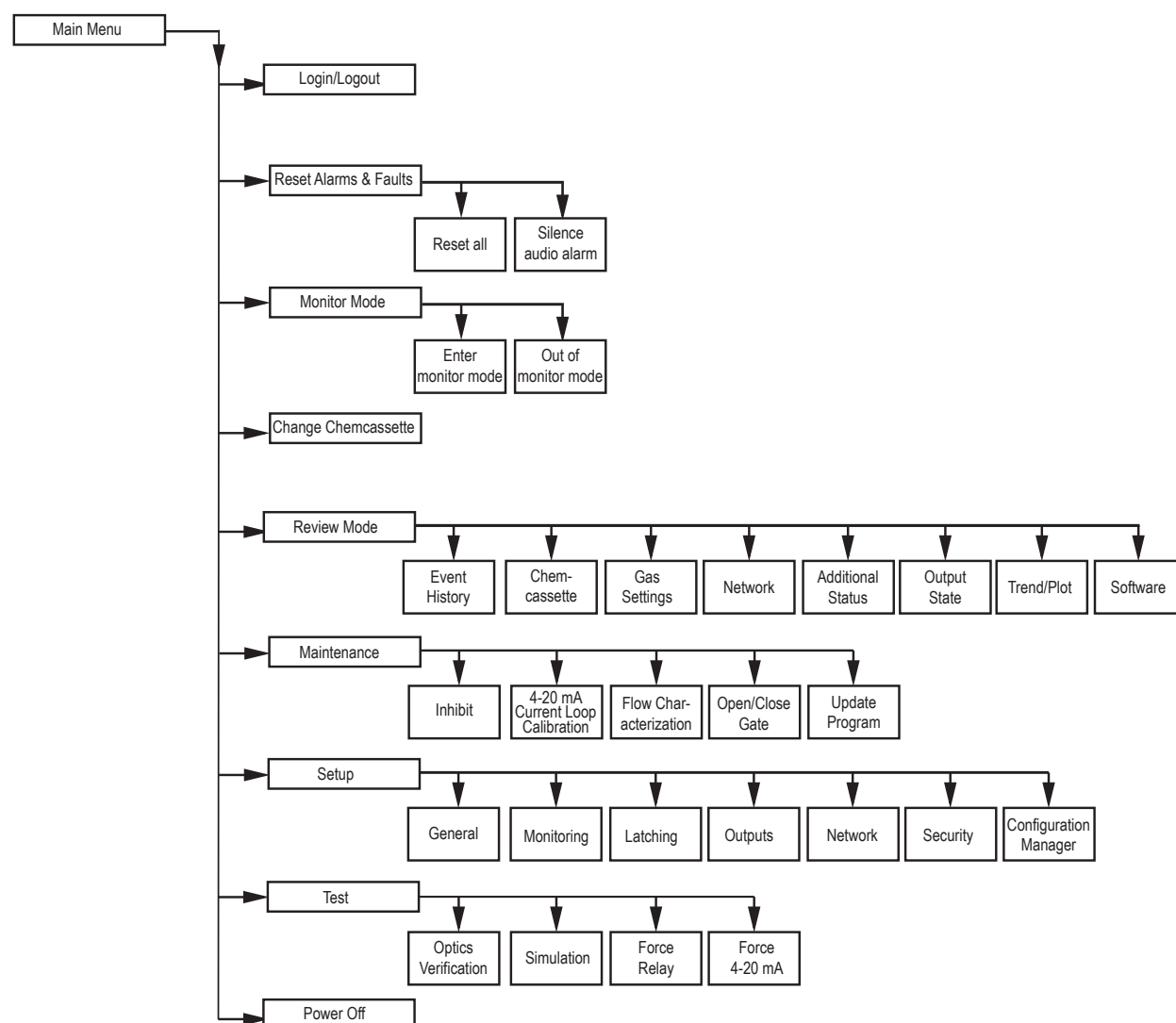

Figure 10. SPM Flex menu map

Have questions?

Honeywell Analytics
 405 Barclay Boulevard
 Lincolnshire, Illinois 60069
 Tel: +1 847 955 8200
 Toll free: +1 800 538 0363
 Fax: +1 847 955 8208
detectgas@honeywell.com