



**Sensepoint XCD RTD
(Remote Toxic Detector)**

1 Safety

Ensure that this Technical Manual is read and understood **BEFORE** installing / operating / maintaining the equipment. Pay particular attention to **Warnings** and **Cautions**. All document **Warnings** are listed here and repeated where appropriate at the start of the relevant chapter(s) of this Technical Manual. **Cautions** appear in the sections/sub-sections of the document where they apply.

WARNINGS

Sensepoint XCD RTD is designed for installation and use in Zone 1 or 2 hazardous areas in many countries including Europe and for Class I, Zone 1 and Class I, Division 2, Group B,C & D Hazardous Areas in the Americas.

Installation must be in accordance with the recognized standards of the appropriate authority in the country concerned.

For Installations in the Americas where conduit is used, refer to the Sensepoint XCD RTD Control Drawing 3001EC088 shown in section 17.

Access to the interior of the detector, when carrying out any work, must only be conducted by trained personnel.

Before carrying out any work ensure local regulations and site procedures are followed. Appropriate standards must be followed to maintain the overall certification of the detector.

If using an anti-seize compound, the threads should be thinly coated with an approved silicone free compound e.g. petroleum jelly

To reduce the risk of ignition of hazardous atmosphere, de-classify the area or disconnect the equipment from the supply circuit before opening the detector enclosure. Keep assembly tightly closed during operation.

Never attempt to open a junction box/enclosure or replace/refit the sensor in potentially hazardous atmospheres while power is still applied to the transmitter.

The detector must be earthed/grounded for electrical safety and to limit the effects of radio frequency interference. Earth/ground points are provided inside and outside the unit. The internal grounding shall be used as the primary equipment ground. The external terminal is only a supplemental bonding connection where local authorities permit or require such a connection.

Ensure that all screens/instrument earth/clean earth wiring is earthed/grounded at a single point (either at the controller or detector - BUT NOT BOTH) to prevent false readings or alarms that may occur due to potential earth/ground loops.

Take care when handling sensors as they may contain corrosive solutions.

Do not tamper with or in any way disassemble the sensor.

Do not expose to temperatures outside the recommended ranges.

Do not expose sensors under storage conditions to organic solvents or flammable liquids.

At the end of their working life, replacement electrochemical sensors for oxygen and toxic gas must be disposed of in an environmentally safe manner. Disposal should be according to local waste management requirements and environmental legislation.

Alternatively, old replaceable sensors may be securely packaged and returned to Honeywell Analytics clearly marked for environmental disposal.

Electrochemical sensors should NOT be incinerated as this action may cause the cell to emit toxic fumes.

Refer to the local or national regulations relative to the installation at the site. For Europe see EN60079-29-2, EN60079-14 and EN61241-14.

Only assessed for ATEX for ignition hazards.

The Sensepoint sensor is a possible Electrostatic risk - Do not rub or clean with solvents. Clean with a damp cloth. High velocity airflows and dusty environments can cause hazardous electrostatic charges.

This equipment is designed and constructed as to prevent ignition sources arising, even in the event of frequent disturbances or equipment operating faults.

Note: Ensure that a suitably rated fuse is used in the gas detection control system to protect the Sensepoint XCD RTD power supply from potential damage.

2 Information

This manual is applicable only for the Sensepoint XCD RTD version of the Sensepoint XCD product range.

Where “Sensepoint Toxic” is mentioned throughout this manual, it refers to the Honeywell Analytics Sensepoint product range of Toxic AND Oxygen gas sensors.

The Start-up/Surge/In rush current is dependant on the type of power supply used. Measure the start-up current using the specific power supply before installation to ensure suitability for your application.

Honeywell Analytics can take no responsibility for installation and/or use of its equipment if not done so in accordance with the appropriate issue and/or amendment of the Technical Manual.

The reader of this Technical Manual should ensure that it is appropriate in all details for the exact equipment to be installed and/or operated. If in doubt, contact Honeywell Analytics for advice.

The following types of notices are used throughout this Technical Manual:

WARNING

Identifies a hazardous or unsafe practice which could result in severe injury or death to personnel.

Caution: Identifies a hazardous or unsafe practice which could result in minor injury to personnel, or product or property damage.

Note: Identifies useful/additional information.

Every effort has been made to ensure the accuracy of this document, however, Honeywell Analytics can assume no responsibility for any errors or omissions in this document or their consequences.

Honeywell Analytics would greatly appreciate being informed of any errors or omissions that may be found in the content of this document.

For information not covered in this document, or if there is a requirement to send comments/corrections about this document, please contact Honeywell Analytics using the contact details given on the back page.

Honeywell Analytics reserve the right to change or revise the information supplied in this document without notice and without obligation to notify any person or organization of such revision or change. If information is required that does not appear in this document, contact the local distributor/agent or Honeywell Analytics.

3 Table of contents

1 Safety	2
2 Information	3
3 Table of contents	4
4 Introduction	6
4.1 Transmitter	7
4.2 Sensepoint Toxic Gas Sensor	7
4.3 Accessories	8
4.4 Options	9
4.4.1 Modbus®	9
5 Installation	11
5.1 Mounting and location	12
5.2 Mounting the transmitter	12
5.3 Installing the sensor	14
5.3.1 Local Sensor Mounting	14
5.3.2 Remote Sensor Mounting	15
6 Electrical connections	16
6.1 Terminal connections	17
6.2 Transmitter Wiring	17
6.2.1 Wiring from Transmitter to Controller	17
6.2.2 Wiring from Transmitter to Sensepoint Toxic	18
6.3 Power	19
6.4 Cabling	20
6.5 Cable and Earth/Ground regimes	20
6.6 Ground Terminal Wiring	21
7 Default configuration	22
8 Normal Operation	24
8.1 Display Screen	24
8.2 System Status	25
8.3 Magnetic Wand Activation	26
8.4 Operation Mode Structure	26
9 First time switch on (Commissioning)	27
9.1 Gas Selection	29
9.1.1 Gas TYPE set up	29
9.1.2 Gas Measuring RANGE set up	31
10 Response Check and Calibration	33
10.1 Zeroing and span calibration	33
11 General Maintenance	37
11.1 Operational Life	37
12 Servicing	38
12.1 Sensor replacement	38
12.2 Replacing Modules within the Transmitter	40
12.3 Faults and Warnings	41
13 Menu's and Advanced Configuration	42

13.1 Abort Function	42
13.2 Configuration Mode	42
13.2.1 Configuration mode operation table	45
13.3 Review Mode	47
14 General specification	50
15 Ordering information	51
16 Warranty statement	53
17 Installation Drawing	54
17.1 Mechanical Installation Drawing	54
17.2 Electronic Connection Drawing	55
17.3 Sensepoint XCD RTD Typical Installation Drawing	57
17.4 Mounting Bolt Assy Drawing	58
17.5 Mounting Bracket Drawing	59
17.6 Control Drawing	60
18 Certification	62
18.1 China GB Ex and PA	62
18.2 Korea KTL	65
18.3 European ATEX	66
18.4 International IEC	69
18.5 North America cCSAus	71
18.6 ATEX Name Plate	74
18.7 cCSAus Transmitter Name Plate	75
18.8 cCSAus Sensor Name Plate	76
18.9 EU Declaration of Conformity	77
19 Cross Interference and Cross Calibration	78
A.1 Modbus and the XCD	79
A.2 Modbus Registers	80

4 Introduction

The Sensepoint XCD RTD comprises a gas detector transmitter and a choice of sensors for detecting toxic gas and oxygen. The construction of Sensepoint XCD allows it to be used in hazardous area locations; it may also be used in other areas not classified as hazardous.

There are three different versions of Sensepoint XCD, The RTD version is used with Sensepoint Toxic sensors that can be locally or remotely mounted. The detectable gases for Sensepoint XCD RTD include Ammonia, Chlorine, Nitrogen, Monoxide, Nitrogen Dioxide, Sulphur Dioxide, Oxygen, Hydrogen Sulphide, Carbon Monoxide and Hydrogen.

The transmitter features a display and three programmable relays for controlling external equipment e.g. alarms, sirens, valves or switches. The transmitter provides an industry standard 3-wire, 4-20mA source or sink output for connection to a dedicated gas detection control system or PLC.

Configuration and Maintenance is carried out using a Magnetic Wand, this allows a single user to undertake routine maintenance without needing to access internal components. Sensepoint XCD RTD is suitable for use in Zone 1 or 2 hazardous areas.

Sensepoint XCD RTD comprises of the main parts as shown below.

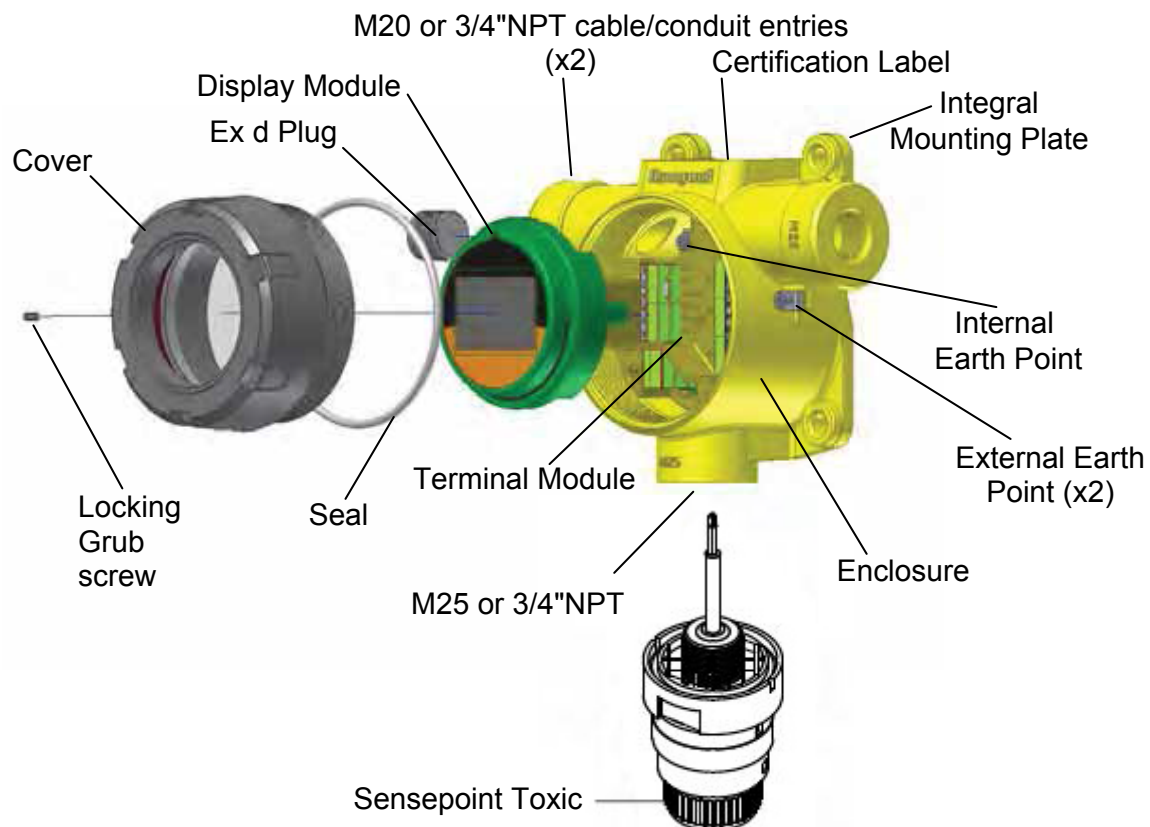

Diagram 1. – Exploded View

4.1 Transmitter

The transmitter enclosure has three threaded entries. The two M20 or 3/4 NPT cable entries either side of the upper part of the transmitter housing are for connecting the power source, signal output and relay contacts to associated signalling equipment. The bottom M25 or 3/4 NPT entry allows local mounting of a Sensepoint Toxic sensor or cable entry when using a remotely mounted sensor. There is a mounting plate incorporated into the transmitter housing allowing for various mounting configuration options.

A local LCD provides gas type, concentration, alarm and operating status. The display provides numerical, bar graph and icon information.

Diagnostic information may also be displayed when the transmitter is interrogated using a magnet. The transmitter cover has a glass window which allows use of the Magnetic Wand to activate the three user interface magnetic switches that are located on the front of the display module. The magnet also enables a non intrusive, one-man calibration and configuration facility for the Sensepoint XCD RTD.

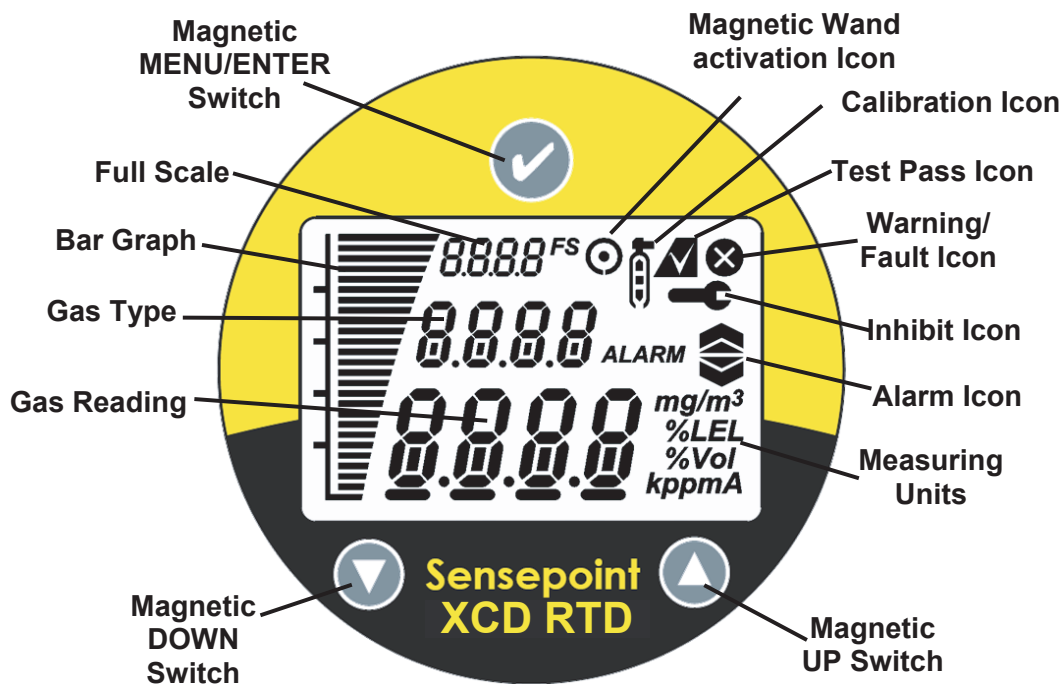

Diagram 2: Sensepoint XCD RTD Display and Magnetic Switches

4.2 Sensepoint Toxic Gas Sensor

The Sensepoint XCD RTD transmitter is designed to work with a range of Sensepoint toxic sensors (see section 7 for details of gases and ranges available) .

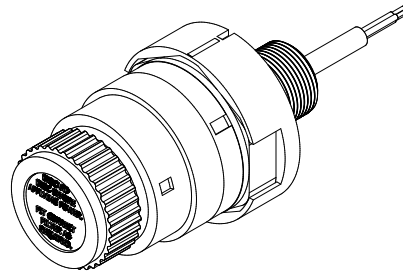
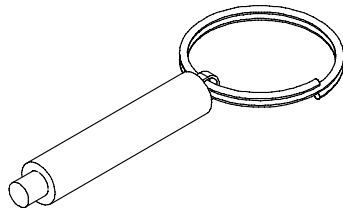

Diagram 3: Sensepoint Toxic Sensor Head for Sensepoint XCD RTD

4.3 Accessories

A range of accessories are available to allow use of Sensepoint XCD RTD in a wide variety of applications. These include Pipe mounting bracket, Sunshade deluge cover, Sensor collecting cone, Sensor flow Housing and Remote sensor mounting junction boxes.



Magnetic wand

The magnetic wand (P/N: SPXCDMAG) is used as a tool to allow the user to communicate with the Sensepoint XCD RTD transmitter for the purpose of configuration, calibration and interrogating system status, (supplied with XCD kit).

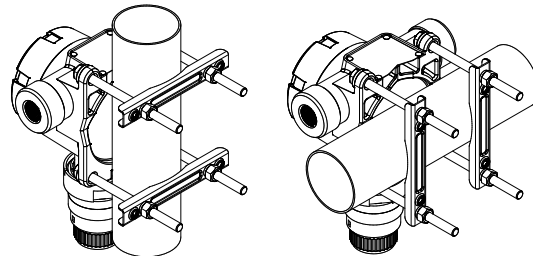

Pipe mounting bracket

The Pipe Mounting Bracket (P/N: SPXCDMTMB) is an optional accessory and may be used to allow the Sensepoint XCD RTD to be installed onto a dedicated mounting post or existing structure at the desired location.

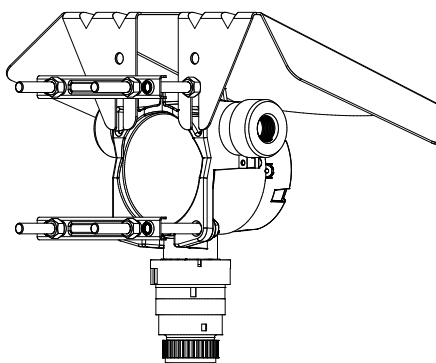

Sunshade Deluge Cover

The XCD Sunshade Deluge Cover (P/N: SPXCSDSP) is an optional accessory that may be fitted to the integral mounting plate. This accessory is designed to protect XCD from overheating in exposed hot and arid climates, particularly offering additional protection from thermal shock in Tropical Environments

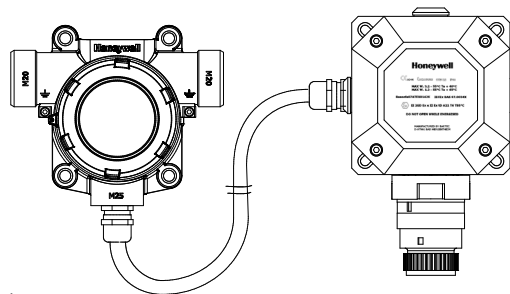

Remote Sensor Mounting

The Junction Box(P/N: 00780-A-0100) is an optional accessory can be used for remote sensor mounting. Make the connection from the junction box to transmitter using suitable cable and cable gland.

4.4 Options

4.4.1 Modbus®

One of the most common field buses in the industry, the optional Modbus® interface allows the XCD to connect to a bus of devices and transmit data to PLCs or controllers (see Appendix A). Connections to the XCD are made through a pluggable terminal block on the Modbus® interface circuit board. Modbus® RTU protocol uses ASCII/Hex protocols for communication. And allows all transmitter/sensor front panel functions to be transmitted using this industrial fieldbus.

Modbus® protocol is a Master-Slaves protocol. Only one master (at the same time) is connected to the bus and one or up to 32 slave nodes are also connected to the same serial bus. Modbus® communication is always initiated by the master. The slave nodes will never transmit data without receiving a request from the master node. The slave nodes will never communicate with each other. The master node initiates only one Modbus® transaction at the same time.

Modbus® option is available only for selected gases. Please refer to chapter 15 Ordering information.

To find out if a unit has the ModBus® option fitted, look at the part number on the product label. Units fitted with ModBus® have the letter “M” at the end of the part number.

Note: MODBUS® is a registered trademark of Schneider Automation Inc.

(MODBUS ID SETTING)

Set id>>Set ModBus slave ID>>Set Baud rate>>Set Parity

- 1) Slave ID shall be set 1~247
- 2) Baud rate setting 9600 or 19200
- 3) Parity setting (No, Even, Odd)

From the Configuration Mode screen, select '✓'. To set the ModBus Slave ID, use the updown '▲▼' switches to move to the desired position and use '✓' to select it. Again, using the '▲▼' switches, increment or decrement the value until the desired value appears, selects the value and moves to the next setting.

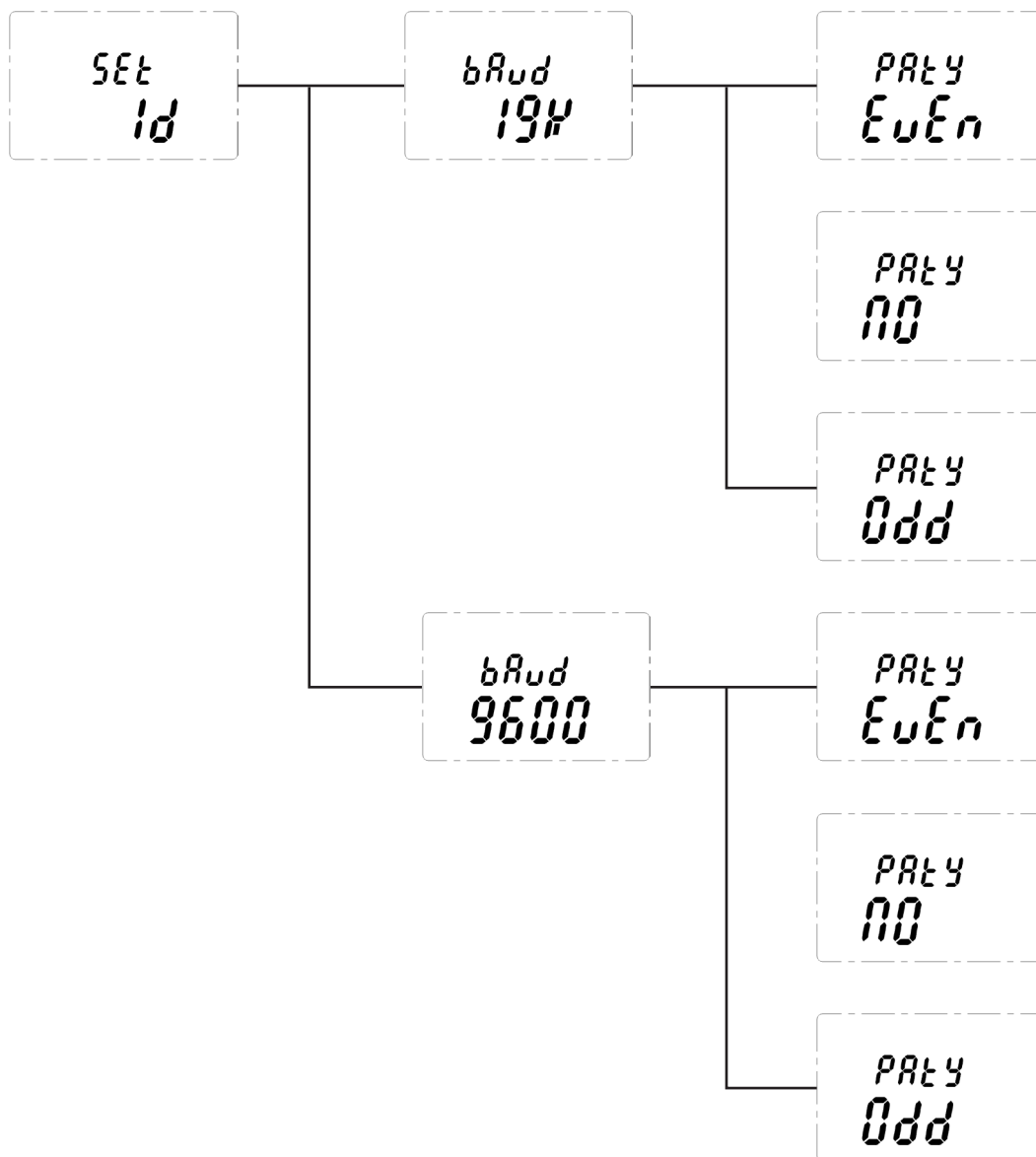

The communications baud rate and Parity Setting can also be set from this screen by using the '▲▼' switches to navigate to the baud rate display then selecting '✓'. Using the '▲▼' switches, highlight the proper baud rate or parity setting and select '✓'. Default is Slave ID 1, 19200bps and even parity.

Note: Modbus settings are effective only for XCD equipped with Modbus option.

5 Installation

For installations in the Americas where conduit is used, refer to the Sensepoint XCD RTD Control Drawing 3001EC088 shown in section 17.

WARNINGS

Sensepoint XCD is designed for installation and use in Zone 1 or 2 hazardous areas in many countries including Europe and for Class I, Zone 1 and Class I, Division 2, Group B,C & D Hazardous Areas in the Americas.

Installation must be in accordance with the recognized standards of the appropriate authority in the country concerned.

Access to the interior of the detector, when carrying out any work, must only be conducted by trained personnel.

Before carrying out any work ensure local regulations and site procedures are followed. Appropriate standards must be followed to maintain the overall certification of the detector.

If using an anti-seize compound, the threads should be thinly coated with an approved silicone free compound e.g. petroleum jelly

To reduce the risk of ignition of hazardous atmosphere, de-classify the area or disconnect the equipment from the supply circuit before opening the detector enclosure. Keep assembly tightly closed during operation.

Never attempt to open a junction box/enclosure or replace/refit the sensor in potentially hazardous atmospheres while power is still applied to the transmitter.

The detector must be earthed/grounded for electrical safety and to limit the effects of radio frequency interference. Earth/ground points are provided inside and outside the unit. Ensure that all screens/instrument earth/clean earth wiring is earthed/grounded at a single point (either at the controller or detector - BUT NOT BOTH) to prevent false alarms due to earth/ground loops.

Take care when handling sensors as they may contain corrosive solutions.

Do not tamper with or in any way disassemble the sensor.

Do not expose to temperatures outside the recommended ranges.

Do not expose sensors under storage conditions to organic solvents or flammable liquids.

At the end of their working life, replacement electrochemical sensors for oxygen and toxic gas must be disposed of in an environmentally safe manner. Disposal should be according to local waste management requirements and environmental legislation. Alternatively, old replaceable sensors may be securely packaged and returned to Honeywell Analytics clearly marked for environmental disposal.

Electrochemical sensors should NOT be incinerated as this action may cause the cell to emit toxic fumes.

Refer to the local or national regulations relative to the installation at the site. For Europe see EN60079-29-2, EN60079-14 and EN61241-14.

Only assessed for ATEX for ignition hazards.

The Sensepoint sensor is a possible Electrostatic risk - Do not rub or clean with solvents. Clean with a damp cloth. High velocity airflows and dusty environments can cause hazardous electrostatic charges.

This equipment is designed and constructed as to prevent ignition sources arising, even in the event of frequent disturbances or equipment operating faults.

Note: Ensure that a suitably rated fuse is used in the gas detection control system to protect the Sensepoint XCD RTD power supply from potential damage.

5.1 Mounting and location

Caution: The placement of gas detectors should be made in accordance with any relevant local and national legislation, standards or codes of practice. Always replace sensors with a sensor of the same type.

Gas detectors should be mounted where a potential hazard of gas is most likely to be present. The following points should be noted when locating gas sensors.

- When locating detectors consider the possible damage caused by natural events e.g. rain or flooding.
- Consider ease of access to the gas detector for functional testing and servicing.
- Consider how escaping gas may behave due to natural or forced air currents.

Note: The placement of gas detectors should be determined following the advice of experts having specialist knowledge of gas dispersion, experts having knowledge of the process plant system and equipment involved, safety personnel and engineering personnel. The agreement reached on the location of detectors should be recorded.

The Honeywell Analytics Gas Book may be referred to for further useful information regarding gas detector mounting and location. Please contact your local sales/service agent for a copy.

5.2 Mounting the transmitter

The Sensepoint XCD transmitter has an integral mounting plate consisting of four mounting holes on the transmitter body. The transmitter may be fixed directly to a surface mounting, or to a horizontal or vertical pipe/structure, 40.0-80.0mm (1.6 to 3.1 inches) in diameter/cross section. The Pipe Mounting Bracket accessory (optional accessory) is designed to be used for this purpose.

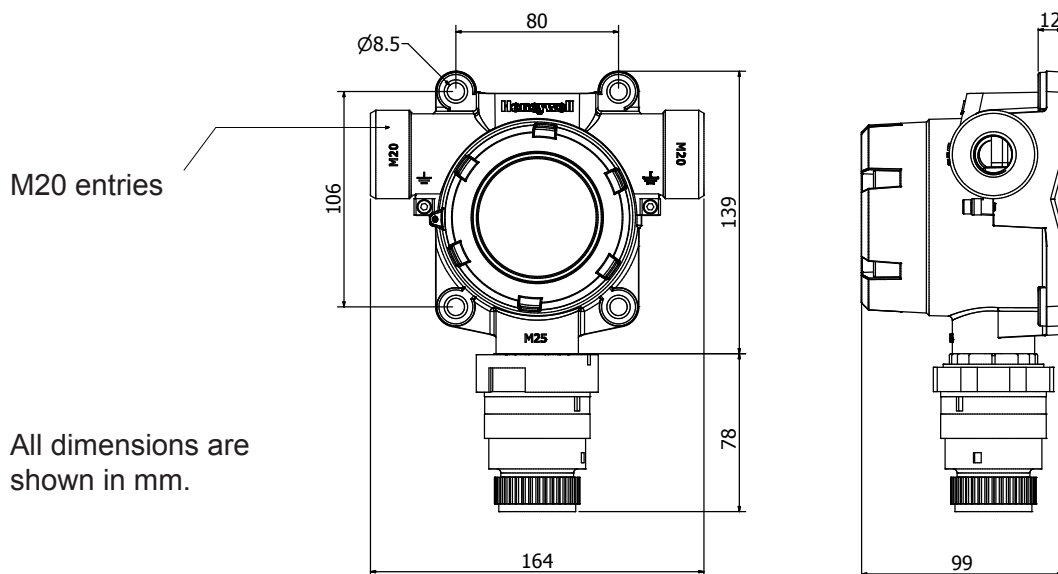

Diagram 4: Outline and mounting dimensions

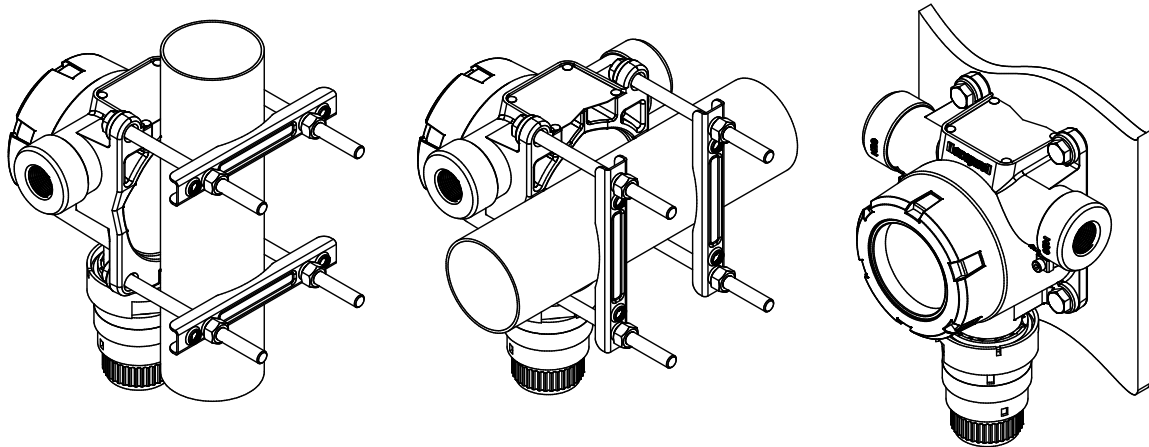

Diagram 5: Mounting arrangements

To mount the Sensepoint XCD transmitter to a Vertical or Horizontal pipe/structure, use the optional XCD Mounting Kit and the following procedure:

1. Fit the four spring washers, then the plain washers to the M8 x 80mm SS316 bolts.
2. Pass the four bolts through the four mounting holes of the transmitter housing.
3. **Note:** If the XCD sunshade is to be used then fit the sunshade and the two locking bolts and washers to the M8 x 80 bolts.
4. Place the transmitter housing against the mounting position and fit the two “U” channel mounting bars the other side of the Pipe/Structure.
5. Secure bolts to the threaded holes of the “U” channel mounting bars.
6. Tighten the four bolts securely, (but do not over-tighten) until the transmitter housing cannot be moved by hand on its mounting position.

Note: For further details of installation please see section 17.

5.3 Installing the sensor

The Sensepoint toxic sensor can be mounted directly to the bottom entry of the XCD RTD transmitter or remotely to a suitable junction box.

5.3.1 Local Sensor Mounting

To mount a sensor directly to the Sensepoint XCD RTD transmitter follow the procedure below

1. Remove the transmitter's cover by loosening the locking screw and unscrewing the cover in a counter-clockwise direction.
2. Remove the display module by firmly pulling it away from the enclosure without twisting it.
3. Feed the sensor wires through the bottom entry into the terminal area.
4. Firmly screw the sensor thread into the bottom entry.
5. Connect the sensor wires to the terminals as shown in section 6.

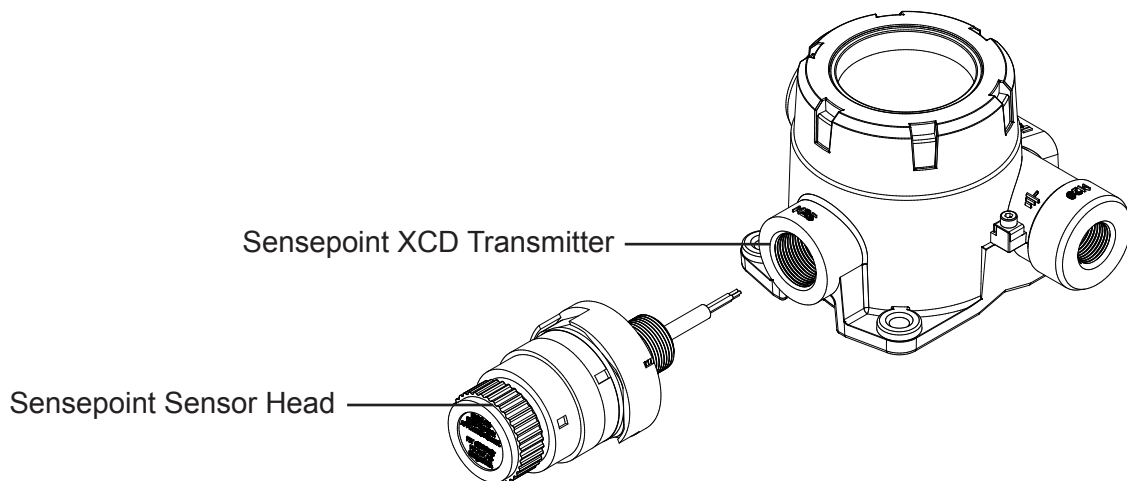

Diagram 6: Installing the Sensor

WARNINGS

Care should be taken when removing and refitting the Sensepoint plug-in Sensor Cartridge so that damage to the connection pins can be avoided.

If using an anti-seize compound, the threads should be thinly coated with an approved silicone free compound e.g. petroleum jelly

Take care when handling old sensors as they may contain corrosive solutions.

The equipment is designed and constructed as to prevent ignition sources arising, even in the event of frequent disturbances or equipment operating faults.

Only assessed for ATEX for ignition hazards.

5.3.2 Remote Sensor Mounting

A remotely mounted sensor should be mounted using a suitable junction box or approved electrical conduit scheme. For further details regarding mounting sensors to suitable junction boxes refer to the relevant sensor manual.

To remotely mount the sensor, follow the procedure below.

1. Select a suitably certified junction box.
2. Fit the sensor to the junction box (refer to sensor manual)
3. Connect the junction box to the transmitter using suitable cable and cable glands
4. Terminate the wires from the sensor in the transmitter as shown in section 6.

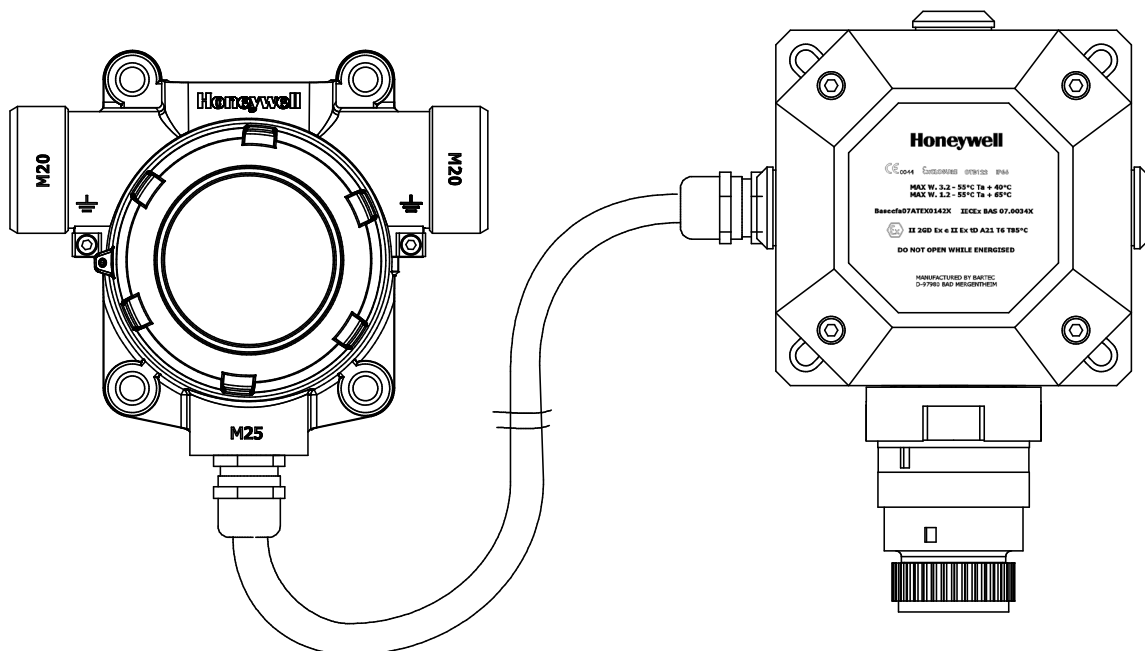

Diagram 7: Remote Sensor Mounting

6 Electrical connections

WARNINGS

Sensepoint XCD is designed for installation and use in Zone 1 or 2 hazardous areas in many countries including Europe and for Class I, Zone 1 and Class I, Division 2, Group B,C & D Hazardous Areas in the Americas.

Installation must be in accordance with the recognized standards of the appropriate authority in the country concerned.

For installations in the Americas where conduit is used, refer to the Sensepoint XCD RTD Control Drawing 3001EC088 shown in section 17.

Access to the interior of the detector, when carrying out any work, must only be conducted by trained personnel.

Before carrying out any work ensure local regulations and site procedures are followed. Appropriate standards must be followed to maintain the overall certification of the detector.

If using an anti-seize compound, the threads should be thinly coated with an approved silicone free compound e.g. petroleum jelly

To reduce the risk of ignition of hazardous atmosphere, de-classify the area or disconnect the equipment from the supply circuit before opening the detector enclosure. Keep assembly tightly closed during operation.

Never attempt to open a junction box/enclosure or replace/refit the sensor in potentially hazardous atmospheres while power is still applied to the transmitter.

The detector must be earthed/grounded for electrical safety and to limit the effects of radio frequency interference. Earth/ground points are provided inside and outside the unit. Ensure that all screens/instrument earth/clean earth wiring is earthed/grounded at a single point (either at the controller or detector - BUT NOT BOTH) to prevent false alarms due to earth/ground loops.

Take care when handling sensors as they may contain corrosive solutions.

Do not tamper with or in any way disassemble the sensor.

Do not expose to temperatures outside the recommended ranges.

Do not expose sensors under storage conditions to organic solvents or flammable liquids.

At the end of their working life, replacement electrochemical sensors for oxygen and toxic gas must be disposed of in an environmentally safe manner. Disposal should be according to local waste management requirements and environmental legislation.

Alternatively, old replaceable sensors may be securely packaged and returned to Honeywell Analytics clearly marked for environmental disposal.

Electrochemical sensors should NOT be incinerated as this action may cause the cell to emit toxic fumes.

The Sensepoint sensor is a possible Electrostatic risk - Do not rub or clean with solvents. Clean with a damp cloth. High velocity airflows and dusty environments can cause hazardous electrostatic charges.

Refer to the local or national regulations relative to the installation at the site. For Europe see EN60079-29-2, EN60079-14 and EN61241-14.

6.1 Terminal connections

Note: Ensure that none of the wires in the terminal area cause an obstruction when refitting the Display Module. Ensure that the socket on the Display Module is fully engaged in the Display Module Connector on the Terminal Module.

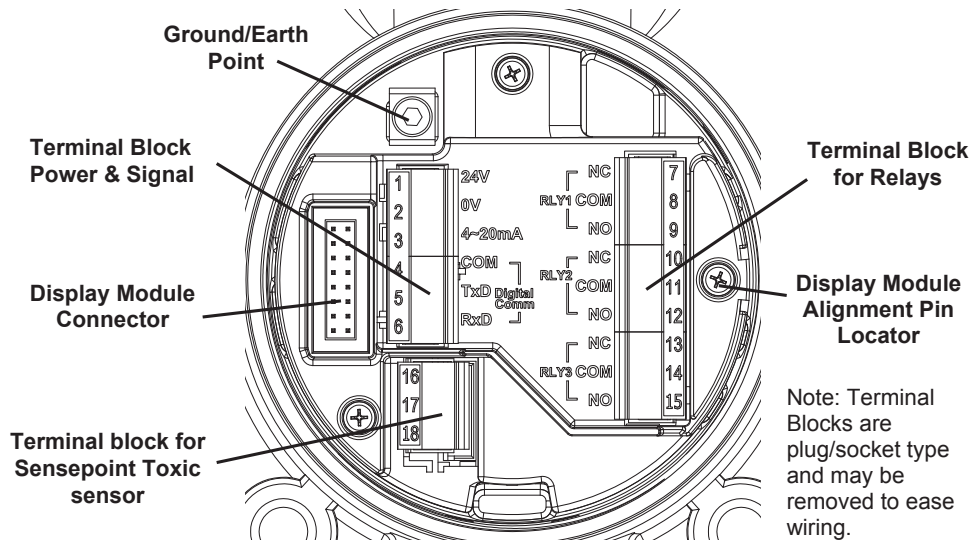

Diagram 8: Sensepoint XCD RTD Terminal module

6.2 Transmitter Wiring

Caution: All electrical connections should be made in accordance with any relevant local or national legislation, standards or codes of practice.

6.2.1 Wiring from Transmitter to Controller

The Sensepoint XCD transmitter may be wired in either Current SOURCE or Current SINK configuration. These two options are offered to allow greater flexibility in the type of control system that it can be used with. SOURCE/SINK is selectable via the switch located on the back side of the display module; accessible by removing the display module during installation / commissioning (see section 9).

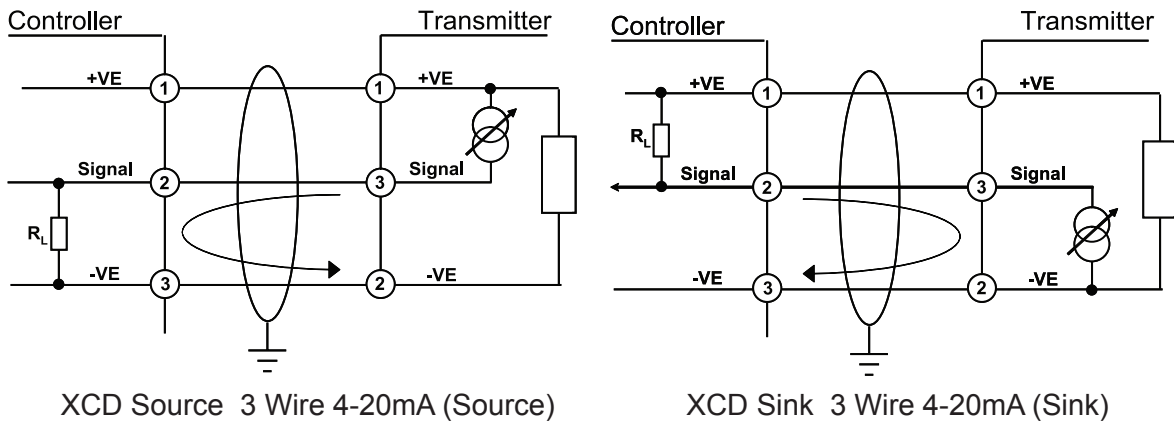

Note: Terminate cable screen at transmitter or controller, not both.
250ohm load resistor (RL) is installed in the factory, In case of connection with controller, this resistor should be removed because controller has load resistor internally.

Terminal Module Connections			
Terminal Number	Marking	Connection	Description
1	24V	+VE Supply(16-32VDC)	Controller Connections
2	0V	-VE Supply(0VDC)	
3	4~20mA	Current Output Signal	
4	COM	Drain	MODBUS RTU. RS485
5	TxD	MODBUS B (+)	
6	RxD	MODBUS A (-)	
7	RLY1/NC	Normally Closed	Programmable Relay 1 (Default A1)
8	RLY1/COM	Common	
9	RLY1/NO	Normally Open	
10	RLY2/NC	Normally Closed	Programmable Relay 2 (Default A2)
11	RLY2/COM	Common	
12	RLY2/NO	Normally Open	
13	RLY3/NC	Normally Closed	Programmable Relay 3 (Default Fault)
14	RLY3/COM	Common	
15	RLY3/NO	Normally Open	
16	+VE(Red)	+24V DC	Sensor Connection for RTD
17	-VE(Blue)	4~20mA	
18	Unused		

Table 1: Sensepoint XCD RTD Terminal connections

6.2.2 Wiring from Transmitter to Sensepoint Toxic

The sensor wiring for XCD RTD allows a mA input range of 0mA to 24mA max, and it will be saturated to 24mA when more than 24mA current is applied to the XCD RTD.

2 Wire 4~20mA (Source)

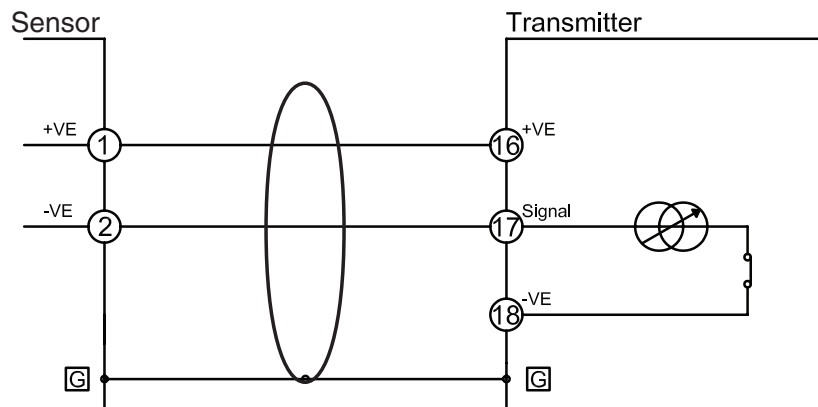

Note: Ensure that the earth from the Sensepoint Toxic Sensor is connected to the Ground/Earth Point.

6.3 Power

The Sensepoint XCD transmitter requires a power supply from the controller of between 16Vdc and 32Vdc. Ensure that a minimum supply of 16Vdc is measured at the sensor, taking into account the voltage drop due to cable resistance.

The maximum loop resistance in the field cable is calculated as follows:

$$R_{\text{loop}} = (V_{\text{controller}} - V_{\text{detector min}}) / I_{\text{detector}}$$

Example;

The controller is supplying a nominal 24Vdc ($V_{\text{controller}}$), the detector minimum allowable voltage is 16Vdc ($V_{\text{detector min}}$), therefore the maximum allowable voltage drop between the controller and detector is 8Vdc; this means a voltage drop of 4V in each core (+ve core and -ve core).

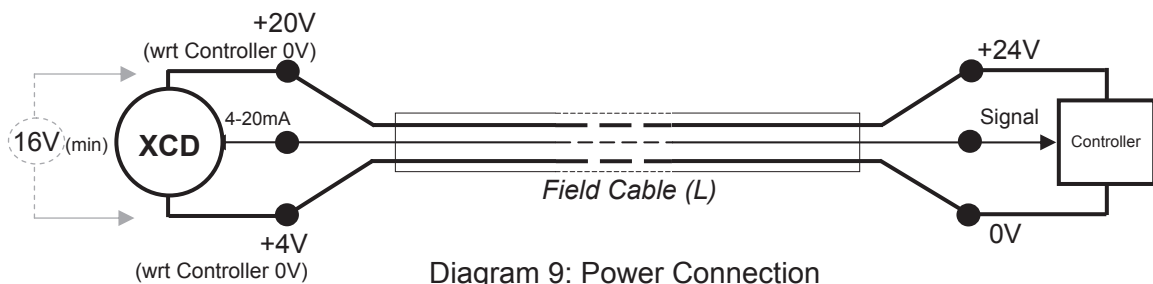

Diagram 9: Power Connection

Power consumption of the detector is 5.0W. The current required to drive the detector at the minimum voltage is ($I = P / V$), $5 / 16 = 312.5$ mA (I_{detector}).

So, the maximum field cable loop resistance (R_{loop}) = $8 / 0.31 = 26$ Ohms, or 13 Ohms per core, (allowing for component variations, losses, etc.).

The following tables show the maximum cable distances between the controller and transmitter assuming a voltage drop of 4V in each core and for different cable parameters. The tables are examples only and actual cable parameters and source power supply voltage for the application should be used to calculate the maximum cable distance allowed at the installation site.

Typical cable data		Maximum Cable length (L)	
Cable size (cross sectional area)	Cable resistance Ω/km (Ω/mi)	Meters	Feet
0.5mm ² (20AWG*)	36.8 (59.2)	353	1158
1.0mm ² (17AWG*)	19.5 (31.4)	666	2185
1.5mm ² (16AWG*)	12.7 (20.4)	1023	3356
2.0mm ² (14AWG*)	10.1 (16.3)	1287	4222
2.5mm ² (13AWG*)	8.0 (12.9)	1621	5318
*nearest equivalent			

Table 2: Maximum cable distances

6.4 Cabling

The use of industrial grade, suitably armoured field cable is recommended.

For example, screened 3 cores (plus screen 90% coverage), suitably mechanically protected copper cable with a suitable M20 explosion-proof gland, or ¾" NPT steel conduit, with 0.5 to 2.5 mm² (20 to 13 AWG) conductors. Ensure the cable gland is installed correctly and fully tightened. All unused cable/conduit entries must be sealed with a suitable certified sealing plug (one plug is supplied).

6.5 Cable and Earth/Ground regimes

Effective Earth/Ground bonding is important to ensure good EMC and RFI immunity.

The following diagrams show examples of how to earth/ground bond the cable at enclosures. The same principles apply to conduit installations. These bonding techniques provide good RFI/EMC performance. Earth/ground loops must be avoided to prevent the risk of false signal variation.

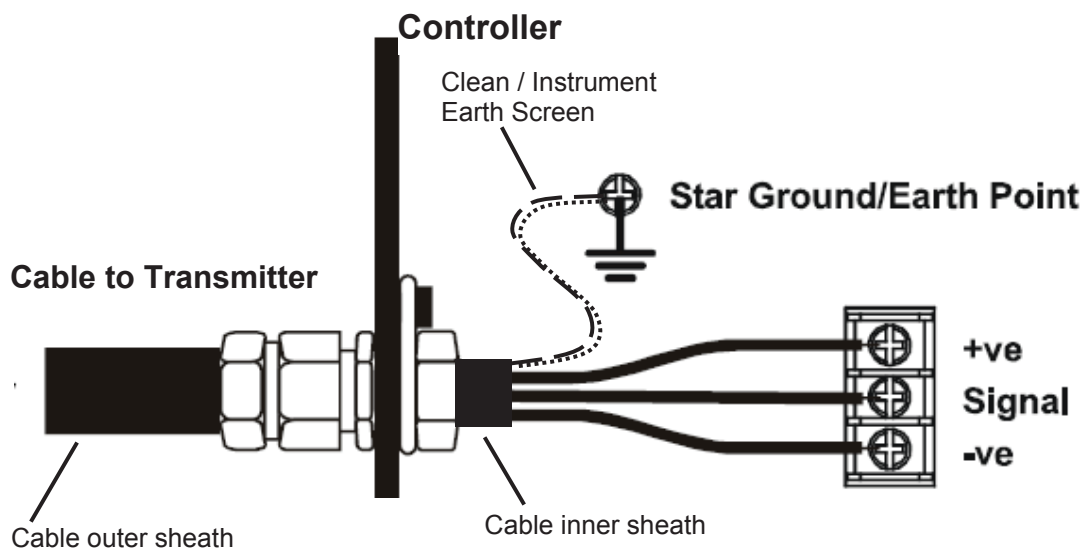

Diagram 10: Controller Grounding

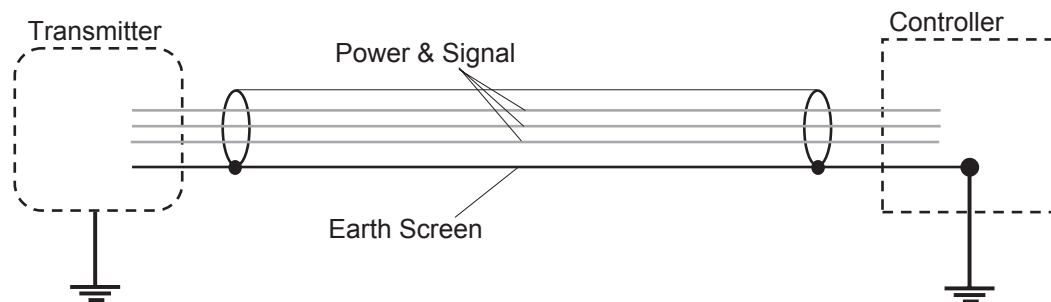
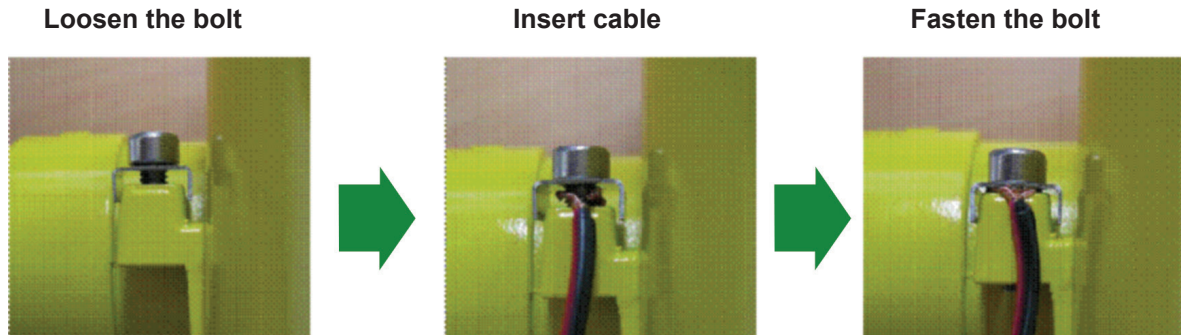

Diagram 11: System grounding

The Earth Screen of the field cable should be “tied to Earth” or connected to Ground at one point only. It is common practise to adopt a STAR EARTH connection regime where all instrumentation Screens are connected at one common point.

The Screen at the other end of the cable should be “parked” or terminated into a blank terminal.

The following diagrams show how to install the wire into the ground screw of the enclosure.



6.6 Ground Terminal Wiring

Internal Ground connection: Utilize the shield of the wiring cable recommended in the wiring instructions. For connection to this terminal. Twist the shield wire to avoid stray shield wires, Loosen the screw sufficiently and wrap the wire around the screw in a “U” shape. Raise the clamp and place the wire between the clamp and ground base, lower the clamp and tighten the screw to 6.9lb-in torque.

External Ground Connection: If required by local authority, Utilize a No 14 AWG copper, (Stranded or Solid), wire. Loosen the screw sufficiently to enable ‘wrapping the wire around the screw in a “U” shape. Raise the clamp and place the wire between the clamp and ground base, lower the clamp and tighten the screw to 10.4lb-in torque.

7 Default configuration

The Sensepoint XCD transmitter is supplied with the following default configuration.

Function	Value/Setting	Meaning
Signal output	$\geq 0.0 < 1.0$ mA	Fault (refer to table 5 section 12.3 for details)
	2.0 mA or 4.0 mA (17.4mA)	Inhibit (during configuration/user settings) For Oxygen, 2.0 mA or 17.4 mA
	4.0 mA to 20.0 mA	Normal gas measurement
	22.0 mA	Maximum over range
Alarm Relay 1*	Value is sensor dependant	Lower alarm level
	De-energized	Energizes on alarm
	Contact Normally Open (NO)	Closes on alarm
Alarm Relay 2*	Value is sensor dependant	Higher alarm level
	De-energized	Energizes on alarm
	Contact Normally Open (NO)	Closes on alarm
Fault Relay	<1mA	Detector Fault
	Energized	De-energizes on alarm
	Contact Normally Open (NO)	Closes on alarm
Inhibit	2.0 mA (default) or 4.0 mA for Toxic and Flammable 2.0 mA (default) or 17.4 mA For Oxygen	Signal output inhibited during menu use. If any relay is set to inhibit relay, then inhibit relay will be activated.
Timeout	Disabled	No inhibit timeout. The detector waits for a button press before returning to the previous state/setting. Timeout period can be set in 'Configure Inhibit' menu in Configuration Mode.
Password	0000 (Disabled)	0000 (Password disabled). If changed then password is activated.
Location (Tag Number)	0000	Optional feature to identify the location or User's "Tag" number of the XCD
Gas Type	CO	Gas type must be set up manually during commissioning, see section 9.1 for procedure on how to set the Gas Type and measuring range of the sensor to be used with Sensepoint XCD RTD.
Temperature	°C	Option to have °C or °F
ModBus	ID, baud rates and Parity bit	ID : 1 Baud rates : 19,200 Parity bit : EVEN

* Alarm relays automatically reset when reading falls within alarm thresholds. If relay configured to LATCH, then relays must be reset using the Magnetic Wand.

Table 3: Default configuration

Gas Name	Displayed Name	Range	Lower Alarm	Lower Alarm Type	Higher Alarm	Higher Alarm Type	Lowest alarm level
Hydrogen Sulfide	H ₂ S	20.0 ppm	4.0ppm	Rising	8.0ppm	Rising	2.0ppm
		50.0 ppm	10.0ppm	Rising	20.0ppm	Rising	5.0ppm
		100 ppm	20ppm	Rising	40ppm	Rising	10ppm
Carbon Monoxide	CO	100 ppm	30ppm	Rising	60ppm	Rising	10ppm
		200 ppm	40ppm	Rising	80ppm	Rising	20ppm
		500 ppm	100ppm	Rising	200ppm	Rising	50ppm
Chlorine	Cl ₂	5.0 ppm	0.5 ppm	Rising	2.0ppm	Rising	0.5ppm
		15.0 ppm	1.5 ppm	Rising	6.0ppm	Rising	1.5ppm
Ammonia	NH ₃	50.0 ppm	20.0ppm	Rising	30.0ppm	Rising	5.0ppm
		100 ppm	20ppm	Rising	40ppm	Rising	10ppm
		1000 ppm	200ppm	Rising	400ppm	Rising	100ppm
Hydrogen	H ₂	1000 ppm	200ppm	Rising	400ppm	Rising	100ppm
	H ₂	9999 ppm	2000ppm	Rising	4000ppm	Rising	1000ppm
Nitrogen Monoxide	NO	100 ppm	20ppm	Rising	40ppm	Rising	10ppm
Sulphur Dioxide	SO ₂	15.0 ppm	2.0ppm	Rising	6.0ppm	Rising	1.5ppm
	SO ₂	50.0 ppm	5.0ppm	Rising	20.0ppm	Rising	5.0ppm
Nitrogen Dioxide	NO ₂	10.0 ppm	2.0ppm	Rising	4.0ppm	Rising	1.0ppm
Oxygen	O ₂	25.0% V/V	19.5%Vol	Falling	23.5%Vol	Rising	10.0%Vol

Table 4: Gas Type and measuring range

For details of how to change the configuration of the Sensepoint XCD please refer to section 13.

8 Normal Operation

Sensepoint XCD RTD is supplied configured and ready for use according to the “Default Settings” table shown above. However these setting may be tailored to a specific application requirement using the Sensepoint XCD RTD configuration menu system.

Access to the Sensepoint XCD RTD transmitter’s configuration menus system is via the Magnetic Activation Tool.

8.1 Display Screen

The Sensepoint XCD RTD display features an LCD with Numeric and bar-graph gas concentration data, alpha-numeric warning and status indication, a target for magnetic switch activation and the UP/DOWN/ESC/ENTER zones for remote configuration. The LCD is also backlit with hi-intensity multi-colour LED indicator to show NORMAL, ALARM and FAULT status.

During normal operation the instrument display shows a steady GREEN backlight.

During Low and High Gas Alarm it displays a flashing RED backlight

During Fault condition the instrument display shows a flashing YELLOW backlight.

The screen is visible through the window of the transmitter’s cover. The display shows the gas concentration (both graphically and numerically), range, units, alarm/ fault status, etc.

Note: The detector display may become sluggish in sub-zero temperatures and possibly unclear at temperatures below -40 °C, but the detector continues its gas monitoring function. The display is not damaged and recovers when the temperature increases.

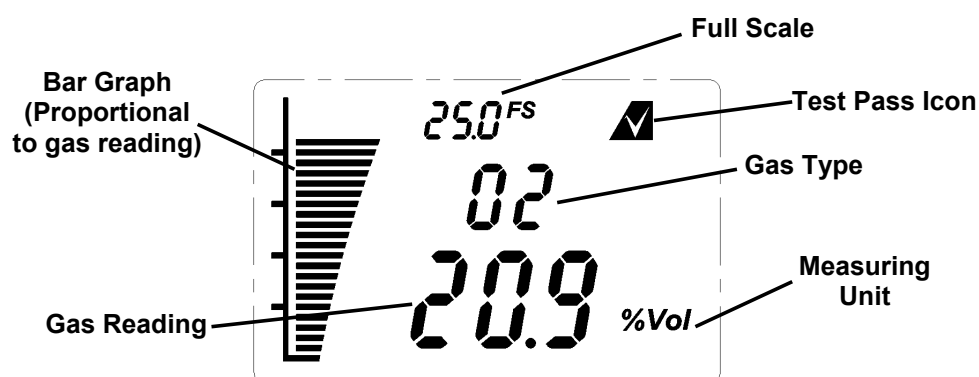

Diagram 12: Example of a O₂ Transmitter Display screen – Normal Operation

8.2 System Status

Display indications, current output and relay states for various operational conditions are shown in the following table. For further details of error messages and trouble shooting see section 12.3.

System Status						
Status	Display	Current Output	Relay			Back Light
			A1	A2	Fault	
Fault: Circuit or sensor error	F-XX fault number with fault icon blinking	0-1.0 mA			✓	Yellow, flashing
System Fault	N/A	0-0.15mA				
Note: In the event of processor failure the watchdog will automatically reset the system for recovery.						
Warning	W-XX warning number with fault icon blinking	Dependent on system status				Green Steady
Normal	0.0 Gas concentration	4-20 mA				Green Steady
Alarm 1	Gas concentration. 1 st alarm icon blinking	4-20 mA	✓			Red, flashing
Alarm 2	Gas concentration. 2 nd alarm icon blinking	4-20 mA	✓ ¹	✓		Red, flashing
Over-range	Full scale icon and reading blinking	22mA	✓	✓ ²		Red, flashing
Inhibit	Inhibit icon dependent on Menu command. If any relay is set to inhibit relay, then inhibit relay will be activated.	2 or 4mA depending on configuration. Note: 2 or 17.4mA for Oxygen version				Green Steady

Table 5: System status

Note:

1. For Oxygen, A1 relay will not be activated because AL1 is configured to activate above 23.5 %Vol (in Rising Alarm configuration).

2. For Oxygen, A2 relay will not be activated because AL2 is configured to activate below 19.5 %Vol (in Falling Alarm configuration).

8.3 Magnetic Wand Activation

The magnetic wand is used as a tool to allow the user to communicate with the Sensepoint XCD RTD transmitter. Communication with the XCD RTD is achieved by positioning the Magnetic Wand at one of three different positions on the front glass window of the Sensepoint XCD RTD transmitter. Activation of the switches is verified by observing the Magnetic Wand Activation Icon on the LCD RTD display

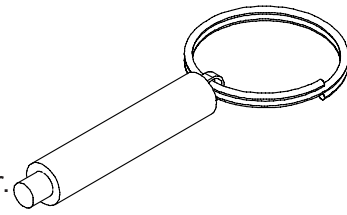

Hold the Magnetic Wand in position for up to 2 seconds = ●

Hold the Magnetic Wand in position for 3 seconds or more = ⊙

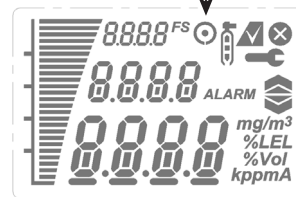

8.4 Mode Structure

Sensepoint XCD RTD has 3 operating modes.

1. **Monitoring mode**, is the normal operating status while XCD RTD measures and displays gas concentration. The fault/warning status is periodically checked, relay contacts are activated according to the configuration.
2. **Configuration mode**, this mode allows parameters relating to the configuration of the Transmitter functions to be changed according to specific needs. This mode can be protected by a password mechanism to prevent unauthorised changes being made.
3. **Review mode**, allows the user to view the current configuration settings.

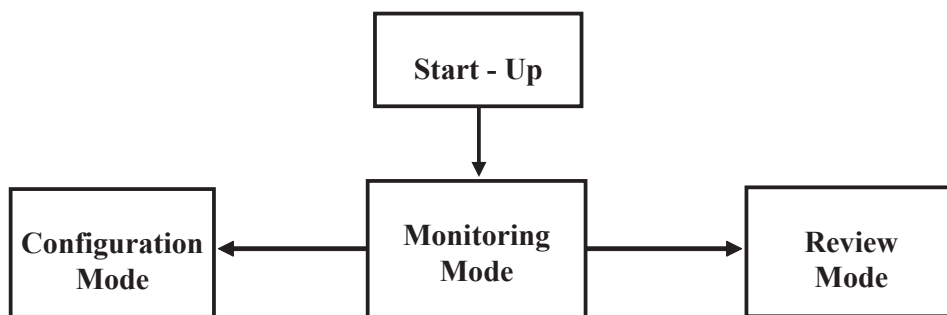

Diagram 13: Mode Structure

Further details of the information available and configuration options for the Sensepoint XCD can be found in Section 13. of this manual.

9 First time switch on (Commissioning)

WARNING

The following procedure requires the Transmitter Cover to be removed while carrying out supply voltage checks. Therefore the appropriate permits to work should be sought in preparation.

Prior to carrying out any HOT WORK ensure local and site procedures are followed. Ensure that the associated control panel output actuation is inhibited so as to prevent false alarms.

Caution: The following procedure should be followed carefully and only performed by suitably trained personnel

Note: Calibration is mandatory before the detector can be used for gas monitoring. Refer to Section 10.1 Calibration for the proper procedure.

1. Remove the transmitter housing cover and detach the display unit by lifting the semi-circular handle and pulling the assembly directly away from the termination module (without twisting it)
2. The default setting is Current SOURCE.
3. Check that all electrical connections are terminated correctly as per section 6.
4. Switch On the external power supply to the transmitter at the safe area gas detection controller (or PLC).
5. Using a Digital Multi Meter (DMM), check the Supply Voltage at the terminals 1 (24V) and 2 (0V), this should be a minimum supply voltage of 16Vdc (Maximum supply voltage is 32V DC)
6. Switch Off the external power to the detector.
7. Refit the Display Module and Cover.

Note: Ensure that none of the wires in the terminal area cause an obstruction when refitting the Display Module. Ensure that the socket on the Display Module is fully engaged in the Display Module Connector on the Terminal Module.

Caution: Ensure that power is removed from the Sensepoint XCD RTD transmitter when the display module is plugged into, (or unplugged from) the terminal module. Failure to remove power may cause hardware damage.

8. Switch On external power to the detector.
9. All the display icons/text/numbers are displayed for 3 seconds.

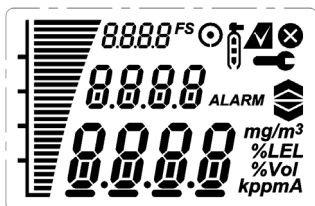

10. A start up sequence will then be displayed, similar to the one shown in Diagram 14.

Note:

For a full description of each screen shown in Diagram 14., please refer to Section 13.3 “Review Mode” of this Manual.

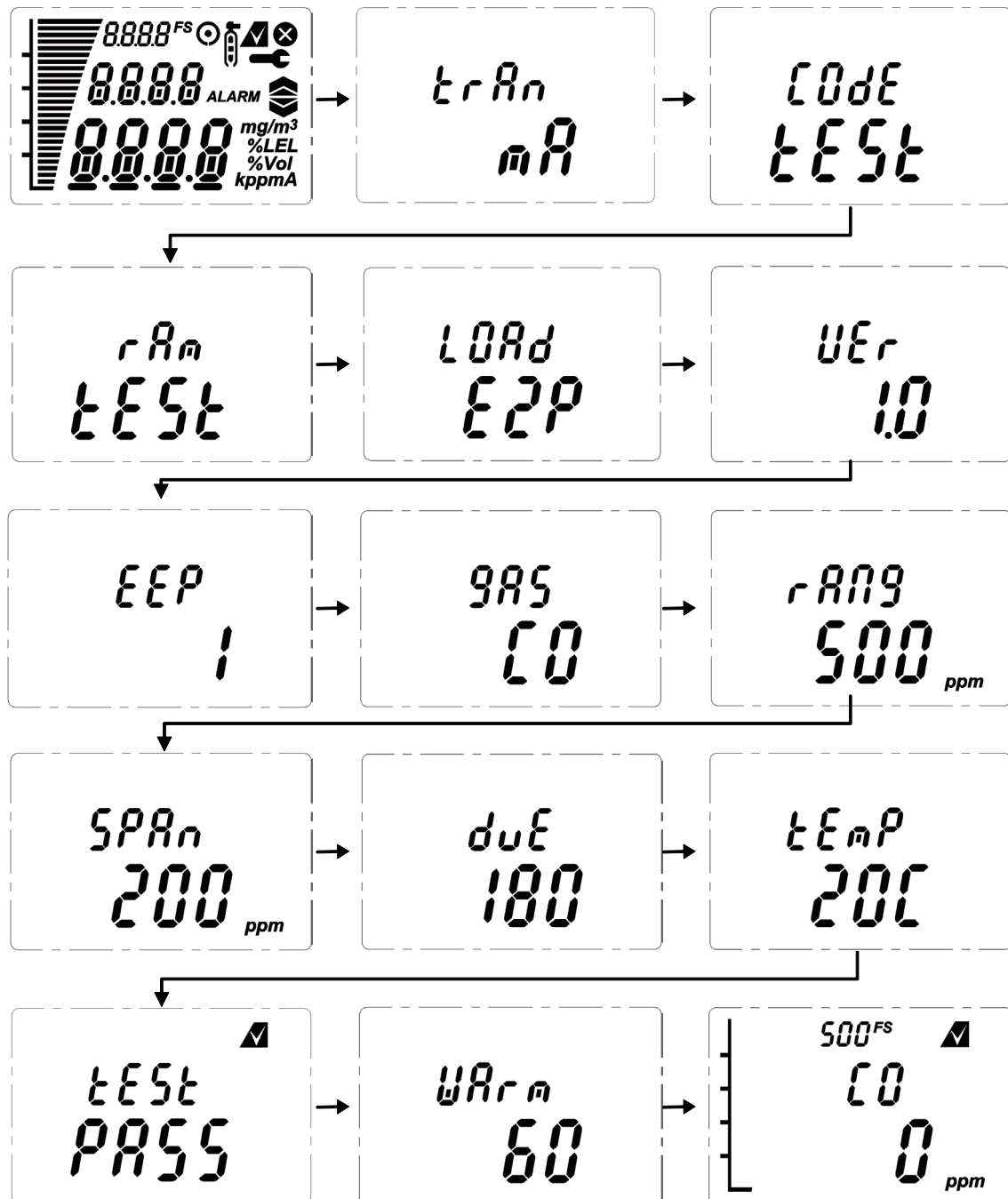

Diagram 14: Normal Start up procedure (For the CO sensor version)

- The warm up countdown of 60 seconds (depending on the gas type) is then displayed.
- Normal **Monitoring Mode** is then resumed.

9.1 Gas Selection

The Sensepoint XCD RTD Transmitter is unable to automatically “know” the type of gas sensor that is connected to it. Therefore, manual set-up of the GAS TYPE and MEASURING RANGE is required. This is done in the following way.

9.1.1 Gas TYPE set up

1. To access the configuration menu, hold the end of the magnet over the switch located at the top center of the XCD RTD display (✓) for at least 3 seconds, until the “confirm” ICON (●) shows on the LCD, and then remove the magnet. The display will indicate ‘SET CAL’
2. Hold the magnet over the (▲) switch for one second and remove. The display will change to ‘SEL GAS’.
3. Hold the magnet over (✓) for one second and remove. The display will change to ‘gAS CO’ (the CO part is flashing).
4. Now, with the magnet, use the (▲) or (▼) switches to scroll (one at a time) through the available gas types until the desired one is found. The available gases are listed as below.

Gas abbreviation	Gas description	Remark
NO	Nitrogen Monoxide	For use with Sensepoint Toxic range of Honeywell Analytics sensors; Default alarm levels, shown in Table 3. will be automatically set according to the measuring range selected (see section 9.1.2).
NO ₂	Nitrogen Dioxide	
Cl ₂	Chlorine	
NH ₃	Ammonia	
H ₂	Hydrogen	
SO ₂	Sulphur Dioxide	
CO(default)	Carbon Monoxide	
H ₂ S	Hydrogen Sulfide	
O ₂	Oxygen	
User	User configurable sensor	The user should specify the target gas name, units (see section 9.1.1.1) and the measurement range (see section 9.1.2).

5. Hold the magnet over (✓) for one second and remove. The display will then show
 - a. ‘LOAD gAS’ for approx 8 seconds, followed by
 - b. ‘LOAD PASS’ for 2 seconds, followed by
 - c. ‘CAL YES’ (the ‘YES’ part is flashing).
6. Calibration should not be done until the range of the sensor has been set, hold the magnet over the (▲) or (▼) switch, the display will then show ‘CAL No’ (the ‘No’ part is flashing).

7. Hold the magnet over (✓) for one second and remove. The display will return to 'SEL GAS'.
8. Hold the magnet over the (▼) switch twice, the display will show 'Quit'. Hold the magnet over (✓) for one second and remove. The XCD RTD will return to normal Monitoring mode and the new GAS TYPE will be shown on the display.

When using a Honeywell Analytics Sensepoint Toxic sensor, go to section 9.1.2.

9.1.1.1 USER Gas Type set up

When a gas detector other than the Honeywell Analytics Sensepoint Toxic range of sensors is to be used with XCD RTD, please set the appropriate Unit of Measure from a pre-selected list and a 'custom' Gas Name which may be edited from 4 available alpha-numeric characters (default is 'CO'), using the following procedure:

1. Complete steps (1.) to (4.) in section 9.1.1. Until the LCD shows 'gAS User' (the User part is flashing).
2. Hold the magnet over (✓) for one second and remove. The display will show 'UNIT' and one of the units of measure will be flashing at the lower right hand side of the LCD.
3. Now with the magnet, use the (▲) or (▼) switches to scroll (one at a time) through the available units of measure until the desired one is found. The available units are listed as below.

Unit of measure	Unit Description
k	Kelvin
A	Ampere
mA	Milli ampere
kppm	Thousands of ppm
mg/m ³	milligram per cubic meter
%Vol	Percent volume
ppm	Parts per million
[blank]	When there is no appropriate unit of measure available, then [blank] can be used. A 'custom' unit of measure may be printed and attached to the instrument manually

4. Hold the magnet over the (✓) switch for one second and remove. The display will then show 'NAME CO' (the first character of 'CO' has a flashing cursor under it).
5. Now with the magnet, use the (▼) switch to scroll (one at a time) through the available alpha-numeric characters until the desired one is found.
6. Hold the magnet over the (▲) switch to move the flashing cursor to the next character and repeat step 5.

7. Once all characters are selected, hold the magnet over the (✓) switch for one second and remove. The display will return to 'SEL GAS'.
8. Hold the magnet over the (▼) switch twice, the display will show 'Quit'. Hold the magnet over the (✓) switch for one second and remove. The XCD RTD will return to normal Monitoring mode and the new GAS NAME will be shown on the display.

9.1.2 Gas Measuring RANGE set up

Whether a Honeywell Analytics Sensepoint Toxic sensor, or an alternative type of gas sensor is to be used with XCD RTD, the Gas Measuring Range of the sensor must be selected manually from a pre-selected list of available measuring ranges, using the following procedure:

1. To access the configuration menu, hold the end of the magnet over the switch located at the top center of the XCD RTD display (✓) for at least 3 seconds, until the "confirm" ICON (●) shows on the LCD, and then remove the magnet. The display will indicate 'SEt CAL'
2. Hold the magnet over the (▲) switch for one second and remove. The display will change to 'SEL GAS'.
3. Hold the magnet over the (▲) switch for one second and remove. The display will change to 'SEt rAng'. Hold the magnet over the (✓) switch for one second and remove.

When a gas detector other than the Honeywell Analytics Sensepoint Toxic range of sensors is to be used, go to step 6.

4. When using a Honeywell Analytics Sensepoint Toxic sensor the display will show 'rAng'. With the magnet, use the (▲) or (▼) switches to scroll (one at a time) through the available choices of gas measuring range.
5. Once the desired measuring range is showing on the display, hold the magnet over the (✓) switch for one second and remove.

Now go to step 13.

6. When a gas detector other than the Honeywell Analytics Sensepoint Toxic range of sensors is to be used, the display will then show 'dPnt' which means Decimal Point.
7. Now with the magnet, use the (▲) or (▼) switches to scroll (one at a time) through the available choices of Decimal Point positions, (choose from: 1, 0.1 or 0.01).
8. Hold the magnet over the (✓) switch for one second and remove. The display will then show 'Low 0.0' (the '0.0' (or '0' or '0.00' part is flashing). 'Low' means the lowest value in any given measuring range.
9. If the lowest (initial) value of the measuring range is at zero (for example in "0 to 100") then do not change this value from its default of 0.

10. Once the desired lower value is showing on the display, hold the magnet over the (✓) switch for one second and remove. The display will then show 'Hlgh 100' (the '100' part is flashing). 'Hlgh' means the highest value in any given measuring range.
11. Now with the magnet, use the (▲) or (▼) switches to select the desired upper value of the measuring range.
12. Once the desired upper value is showing on the display, hold the magnet over the (✓) switch for one second and remove.
13. The display will then show 'CAL YES' (the 'YES' part is flashing).
14. Now hold the magnet over (✓) for one second and remove to begin calibration of the sensor.

Go to section 10.1 (ZERO CALIBRATION), step 5.

10 Response Check and Calibration

It is recommended to periodically carry out a gas response check on the Sensepoint XCD RTD to ensure correct operation. This may be done in two ways;

1. A simple Response Check often referred to as a “BUMP TEST” is a test using calibration gas applied to the sensor via the Weather Protection or using the Sensepoint Gassing Cap.

If a BUMP TEST is done via the Weather Protection it may be necessary in windy conditions to increase the flow rate of the test gas by a further 1 LPM, OR, to shelter the weather protection from the wind.

2. A full gas calibration of the sensor as described in the following section, using ONLY the Gassing Cap (PN: 2106D2097).

10.1 Zeroing and span calibration

Caution: Before initial calibration allow the detector to stabilize for 30 minutes after applying power.

When in zeroing and span calibration mode the current output from the detector is inhibited (default 2mA) to avoid false alarms.

To calibrate the detector, use an appropriate span gas cylinder, constant flow regulator and the Sensepoint Toxic Gassing Cap (refer to Sensepoint Technical Manual 2106M0502 for details). The flow rate is used of approximately 1 to 1.5 litres per minute for calibration. Apply the gas at the flow rate for the recommended application concentration and time please see Table 6.

Gas	Range	Recommended Test Concentration	Application Time Minutes	Operating Temp. Min. Max.
H ₂ S	0 to 20ppm	10ppm	3 mins	-20°C +50°C
H ₂ S	0 to 50ppm	20ppm	3 mins	-20°C +50°C
H ₂ S	0 to 100ppm	50ppm	3 mins	-20°C +50°C
CO	0 to 100ppm	50ppm	3 mins	-20°C +50°C
CO	0 to 200ppm	100ppm	3 mins	-20°C +50°C
CO	0 to 500ppm	250ppm	3 mins	-20°C +50°C
Cl ₂	0 to 5ppm	3ppm	10 mins	-20°C +50°C
Cl ₂	0 to 15ppm	10ppm	10 mins	-20°C +50°C
O ₂	0 to 25% V/V	19% V/V	1 min	-15°C +40°C
NH ₃	0 to 50ppm	25ppm	10 mins	-20°C +40°C
NH ₃	0 to 1000ppm	500ppm	10 mins	-20°C +40°C
H ₂	to 1000ppm	500ppm	3 mins	-15°C +40°C
H ₂	to 10000ppm	3000ppm	3 mins	-15°C +40°C
SO ₂	0 to 15ppm	10ppm	5 mins	-15°C +40°C
SO ₂	0 to 50ppm	20ppm	5 mins	-15°C +40°C
NO	0 to 100ppm	50ppm	5 mins	-15°C +40°C
NO ₂	0 to 10ppm	5ppm	5 mins	-15°C +40°C
NO ₂	0 to 50ppm	20ppm	5 mins	-15°C +40°C

Table 6

A compressed air cylinder (20.9%Vol oxygen) should be used to perform the zero calibration if the area where the detector is located contains any residual amount of the target gas. If no residual gas is present then the background air can be used to perform the zero calibration. Contact your Honeywell Analytics representative for details of suitable calibration kits.

To calibrate the detector follow the procedure below.

Note: the Oxygen sensor does not require a zeroing procedure. Background air (20.9%Vol oxygen) can be used to span the oxygen sensor in place of a compressed air cylinder (20.9%Vol oxygen). For oxygen sensors only do parts 1-4, 13, 14 (if compressed air cylinder is used), 15-17 and 22 of the procedure below.

(ZERO CALIBRATION)

1. If the ambient air is NOT considered reliable to use to set the ZERO, then remove the weather protection and fit the Gassing Cap accessory (see Section 4.3) onto the sensor and apply a clean source of zero gas or compressed air.
2. To access the calibration menu, hold the end of the magnet over the switch located at the top center of the detector display (✓) for at least 3 seconds and then remove.
3. The display will indicate the first configuration mode menu 'SEt CAL'.



4. Put the magnet over the '✓' switch again and move to enter the Calibration menu.
5. The display will show the current gas reading, and the '0' icon flashes.

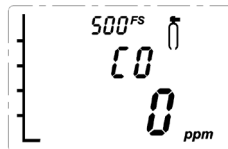

6. Observe the Zero reading on the XCD RTD display. If it shows a stable reading around "0" there is no need to carry out Hardware adjustment. Skip the next step.
7. Open the sensor enclosure by unscrewing the sensor cap assembly from the sensor main body and replace with a Gassing Cap (Part No: 2106D2097) and Flow Housing. If the output, with no gas applied, is not zero then adjust the zero potentiometer through the Gassing Cap access holes (see Diagram 15) to obtain a zero indication.

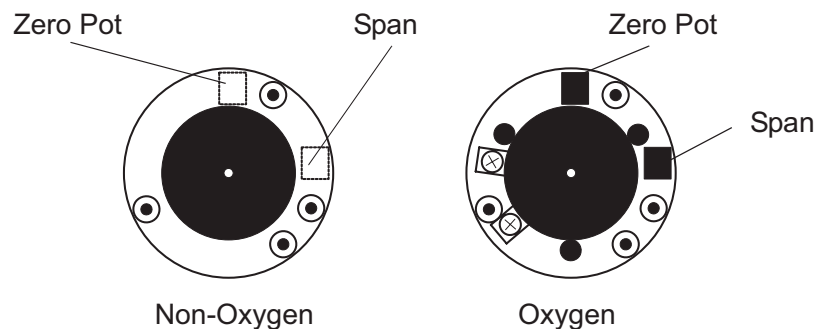
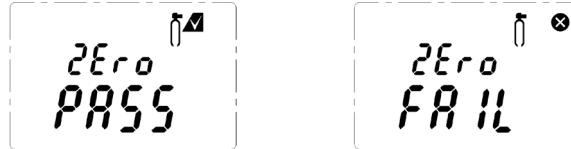

Diagram 15: Sensepoint Toxic Sensor Zero and Span potentiometer

Note: Please refer to Section 3. (page 28) of Sensepoint Technical Manual MAN0514 for the detail procedure on how to adjust the Zero and Span potentiometer.

8. When the zero gas reading is stable use '✓' to confirm zero calibration.
9. If successful the display shows 'ZEro PASS' (if not successful, the display shows 'ZEro FAIL' and returns to configuration mode).



10. If using zero-air, turn it off. Zeroing is complete and saved.
11. The display shows 'SPAN' with 'YES' flashing.



12. If span calibration is required use '✓' proceed to the next step. If span calibration is not required, use '▲▼' to select 'No' and '✓' to return to configuration mode.

(SPAN CALIBRATION)

13. The display shows the current calibration span gas concentration while flashing the '📏' icon. Use '▲▼' to change the calibration span gas concentration, and '✓' when required span calibration level is set.



14. The display will show the current gas reading, and the '📏' icon flashes.
15. Connect the regulator to the span gas cylinder. Apply gas at a flow rate of 1 liter per minute for the recommended application time. (See Table 6).

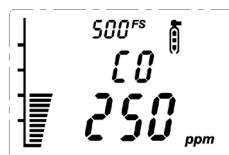

Note: This example assumes a 250ppm span gas for a 0-500ppm CO range for the whole procedure of the calibration.

16. Apply the span gas to the sensor using the Sensepoint XCD Gassing Cap (see section 4.7 for description). The live gas reading is displayed. If the reading is around span gas concentration, there is no need to carry out any Hardware adjustment. Skip the next step.
17. Adjust the span potentiometer through the Gassing Cap access Holes (See Diagram 15) to obtain a span gas concentration indication.

18. When the reading is stable, use '✓' to confirm span calibration.
19. If the sensor has been replaced the following display may be shown.

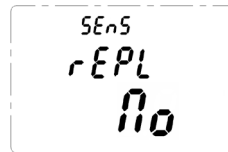

20. Use '▲▼' to select 'YES' if the sensor has been replaced or 'No' if it has not been replaced.
21. If the span calibration is successful the instrument will briefly display 'SPAN PASS' (if fails 'SPAN FAIL' displayed and returns to configuration mode).

Note: the calibration due warning counter is reset after a successful calibration. See section 12.3 for further details of setting a calibration due warning.



22. The display alternates between "Purg gAS" and the gas reading to indicate that the unit is expecting the span gas to be removed from the sensor.

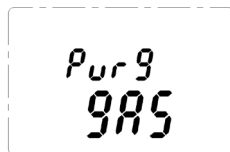

23. Promptly switch off the calibration span gas and remove the Sensepoint XCD Gassing Cap from the sensor to allow the gas to disperse.
24. When the reading falls below 50% of the calibration gas level the display indicates a countdown (up to 180 seconds dependant on gas type).

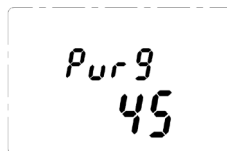

25. When the countdown is finished, the calibration procedure is complete.
26. The instrument returns to the 'Set CAL' menu. Activate the '▲' or '▼' switch to select another menu or select 'Quit' to return to normal monitoring mode.



Note: Remember to always replace the Weather Protection and other accessories.

11 General Maintenance

WARNINGS

Access to the interior of the transmitter, when carrying out any work, must only be conducted by trained personnel.

Before carrying out any work ensure local regulations and site procedures are followed. Appropriate standards must be followed to maintain the overall certification of the sensor and transmitter.

To reduce the risk of ignition of hazardous atmosphere, de-classify the area or disconnect the equipment from the supply circuit before opening the transmitter enclosure. Keep assembly tightly closed during operation.

Never attempt to open a junction box/enclosure or replace/refit the sensor in potentially hazardous atmospheres.

Take care when handling sensors as they may contain corrosive solutions.

Do not tamper with or in any way disassemble the sensor.

Do not expose to temperatures outside the recommended ranges.

Do not expose sensors under storage conditions to organic solvents or flammable liquids.

At the end of their working life, replacement electrochemical sensors for oxygen and toxic gas must be disposed of in an environmentally safe manner. Disposal should be according to local waste management requirements and environmental legislation.

Alternatively, old replaceable sensors may be securely packaged and returned to Honeywell Analytics clearly marked for environmental disposal.

Electrochemical sensors should NOT be incinerated as this action may cause the cell to emit toxic fumes.

The Sensepoint sensor is a possible Electrostatic risk - Do not rub or clean with solvents. Clean with a damp cloth. High velocity airflows and dusty environments can cause hazardous electrostatic charges.

Honeywell Analytics recommends that gas detectors are tested and re-calibrated on a six-monthly basis, or according to site practice. For Sensepoint Toxic sensors that are used either directly with XCD RTD transmitter or remotely mounted in a separate junction box, please refer to individual sensor manual for specific recommended calibration periods.

11.1 Operational Life

Typical life of a toxic gas sensor is dependant on the application, frequency and amount of gas exposure. Under normal conditions (3 monthly visual inspection and 6 monthly test/re-calibration), the XCD toxic sensors have an expected life equal to or greater than 24 months. The XCD Oxygen sensor has an expected life equal to or greater than 12 months.

Refer to section 12 for sensor replacement procedures.

Caution: Oxygen deficient atmospheres (less than 6%V/V) may result in inaccuracy of reading and performance.

12 Servicing

WARNINGS

Take care when handling sensors as they may contain corrosive solutions. Do not tamper or in any way dis-assemble the sensor. Do not expose to temperatures outside the recommended range. Do not expose sensor to organic solvents or flammable liquids.

At the end of their working life, replacement electrochemical sensors for oxygen and toxic gas must be disposed of in an environmentally safe manner. Disposal should be according to local waste management requirements and environmental legislation. Alternatively, old replaceable sensors may be securely packaged and returned to Honeywell Analytics clearly marked for environmental disposal.

Electrochemical sensors should NOT be incinerated as this action may cause the cell to emit toxic fumes.

Caution: The following procedure should be followed carefully and only performed by suitably trained personnel. A fault condition will be signalled by the detector if the sensor is removed with the unit under power.

12.1 Sensor replacement

The Sensepoint Toxic Sensor has a replaceable sensor cartridge. To replace the sensor cartridge follow the procedure below:

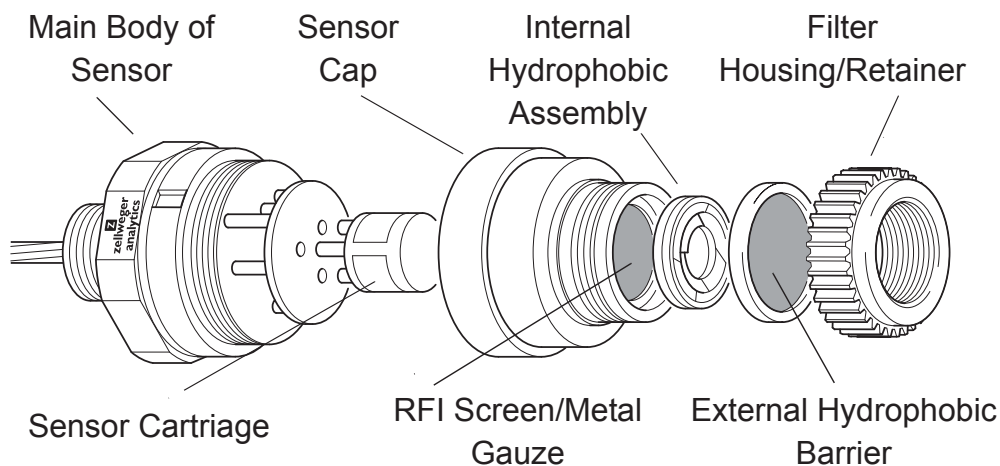

Diagram 16: Sensepoint Toxic Sensor Exploded diagram

Replacing the Sensor Carriage

1. Unscrew and remove the filter housing/retainer (or accessory if fitted) from the sensor.
2. Remove the old internal hydrophobic assembly by pushing against the snap fit, through one of the retaining slots, with a small flat bladed screwdriver.

The assembly will pop out.

Caution: Do not attempt to lever the assembly out as this may damage the housing.

3. Remove the internal metal gauze insert.
4. Open the enclosure by unscrewing the sensor cap assembly from the sensor main body.
Ensure that the electrochemical cell does not rotate with the cap.
5. Gently pull the old electrochemical cell from the PCB.

See the subsequent note about replacing the Oxygen Sensor Carriage

Caution: Dispose of the electrochemical cell in accordance with local regulations.

6. Remove the new cell from its packaging and remove the shorting link across the base of cell.
7. Plug the new cell into the PCB.

Note: For Oxygen Sensepoint, unscrew the old cell connections, then screw in the new one.

8. Screw the sensor cap assembly back onto the sensor main body.
9. Fit the new internal metal gauze assembly.
10. Fit the new internal hydrophobic assembly.

Note: The sensor should now be calibrated. Re-calibration should only be attempted by qualified service personnel.

11. Replace the filter housing/retainer or accessory.
12. In the event of an apparatus failure, return unit to Honeywell Analytics.

WARNING

Ensure that the same Gas Type and Range of Sensor is fitted in place of the old Sensor.

The manufacturer's instructions should be observed.

12.2 Replacing Modules within the Transmitter

Two replaceable module assemblies are located within the transmitter housing. The Display Module and the Terminal Module.

The Display Module is simply removed by unplugging it from the Terminal Module (this procedure is done during normal installation).

To replace the Terminal Module, use the following procedure:

1. Unscrew and remove the Transmitter Cover
2. Lift the handle and un-plug and remove the Display Module.
3. Unplug the connection terminals and lift them clear of the Terminal Module.
4. Disconnect the sensor wires at the terminal block
5. Loosen and remove the three “cross-headed” screws that secure the Terminal Module to the Transmitter housing.
6. Carefully lift the Terminal Module from the transmitter housing.
7. Fit the new Terminal Module using the above procedure in reverse order.

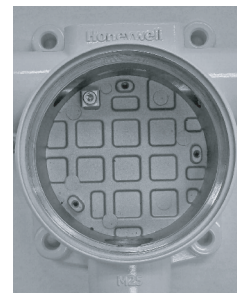
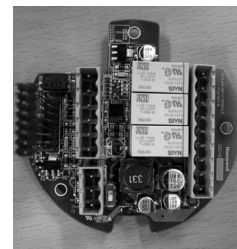
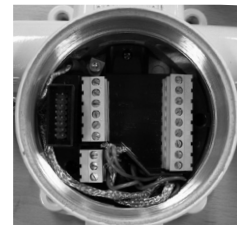
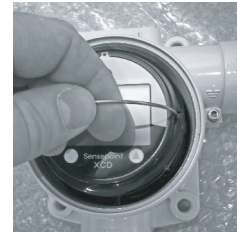

12.3 Faults and Warnings

The table below provides details of possible error.

Message	Description	Action
W-01	Calibration needed	The unit has not been calibrated for the configured calibration interval Calibration is necessary due to change of sensor/gas type
W-02	Transmitter Temperature limits exceeded	Use '✓' to clear when within limits
W-03	Alarm setting needs to be configured	Re-configure alarm settings such that upper alarm should not exceed user configured scale
F-01	Internal I2C failure	Cycle power to detector. Replace detector
F-02	Cell failure or Over range	Replace sensor or Check the input signal wiring.
F-03	Significant zero drift	Re zero/calibrate
F-04	Unexpected sensor fitted	Replace sensor
F-05	EEPROM is corrupted	Reset transmitter. If fault still appear, replace transmitter
F-06	Low supply voltage	Reset transmitter. If fault still appear, replace transmitter
F-07	SRS processor failure	Reset transmitter. If fault still appear, replace transmitter
F-08	RAM read/write fault	Reset transmitter. If fault still appear, replace transmitter
F-09	Info. memory corrupted	Reset transmitter. If fault still appear, replace transmitter
F-10	Code Memory corrupted	Reset transmitter. If fault still appear, replace transmitter
F-11	DAC output failure	Check load resistor or sink/source mode switch was configured properly
F-12	Heater failure	Reset transmitter. If fault still appear, replace transmitter
F-13	Supplied voltage failure	Check supply voltage. Replace detector

Table 7: Fault and Warning List

13 Menu's and Advanced Configuration

13.1 Abort Function

In Review Mode or Configuration Mode the user can escape one step back from the current position using the Abort Function. To do this the user must activate the Enter switch for more than 3 seconds with the Magnetic Wand. Switching between each pair of modes or between menus and sub menus are shown in the following table.

From	To	Example
Review Mode	Monitoring Mode	Activate Enter switch for more than 3 seconds while in Review Mode
Configuration Mode	Monitoring Mode	Activate Enter switch for more than 3 seconds while navigating menus in the Configuration Mode
Configuration Mode sub menu	Configuration Mode main menu	Activate Enter switch for more than 3 seconds while in a sub menu

Table 8: Transmitter menu switching

13.2 Configuration Mode

The table below shows the functions available via the configuration menu that can be displayed on the transmitter and accessed using the Magnetic Wand.











The instrument will show the main Menu when the “Enter” switch is activated with the Magnetic Wand and held for at least 3 seconds.

The Menu is password protected to prevent any unauthorized changes. The password is initially disabled and the default password is ‘0000’. If the default password is changed to other than ‘0000’, then the password is enabled automatically and requested when entering Configuration Mode.

With the Menu showing, the following functions can be performed: calibration, bump test, sensor selection and configuration of parameters such as measuring range, calibration gas level, calibration interval, inhibit current, inhibit timeout, alarm setting, relay setting, password change, location setting, temperature unit reading, force analogue output and alarm function checks.

While in Configuration mode, the output current of the transmitter is inhibited to prevent false alarms.

Names, displays and descriptions for each menu item in Configuration Mode are shown in the following table.

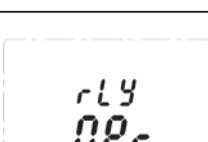
Menu	Display	Description
Set Calibration		Execute zero/span calibration Set calibration gas level After zero, the option exists to proceed with span calibration, or return to the Menu.
Select Gas		Select the type of gas from the list.
Set Range		Set measuring range
Configure Inhibit		Select inhibit current Set timeout option (5 minute increments)
Set Password		Enable/disable password Set password Default – no password (Select '0000')
Set Calibration Interval		Set calibration interval, 30 to 365 days User configurable option to display warning
Bump Test		Execute a 'bump' test to check gas response of the sensor.
Force Current		Force analogue output to test functionality of GD control system during system commissioning.
Set Alarms		Set alarm 1, alarm 2 levels, functionality and operation (none/falling/rising)
Set Relays		Set relay 1,2,3 type (alarm 1, alarm 2, fault and inhibit) and action (energized/de-energized)
Relay Operation		Configure relay on delay time, relay off delay time and latch/non-latch





Set Location		Set location (or TAG number)
Set Temperature Unit		Change temperature display unit. °C (Celcius) or °F (Fahrenheit)
Check Alarm functions		Simulate alarm situation to check the alarm system without gas present at the sensor
Set ID		Change ModBus slave ID, baud and parity bit setting (ModBus version only)
Quit		Return to Monitoring mode

Table 9: Transmitter menu descriptions



13.2.1 Configuration mode operation table

Configuration mode allows the user to perform calibration and configure parameters such as full scale range, calibration gas level, calibration interval, inhibit current & timeout, alarm settings, relay settings, etc. To activate Configuration mode hold the magnet over the ENTER switch for at least 3 seconds and then remove. Configuration mode can be password protected to prevent unauthorized personnel from changing parameters. Initially the password is set to '0000' meaning it is disabled. While in Configuration mode, the output current of the detector is inhibited to prevent false alarms.

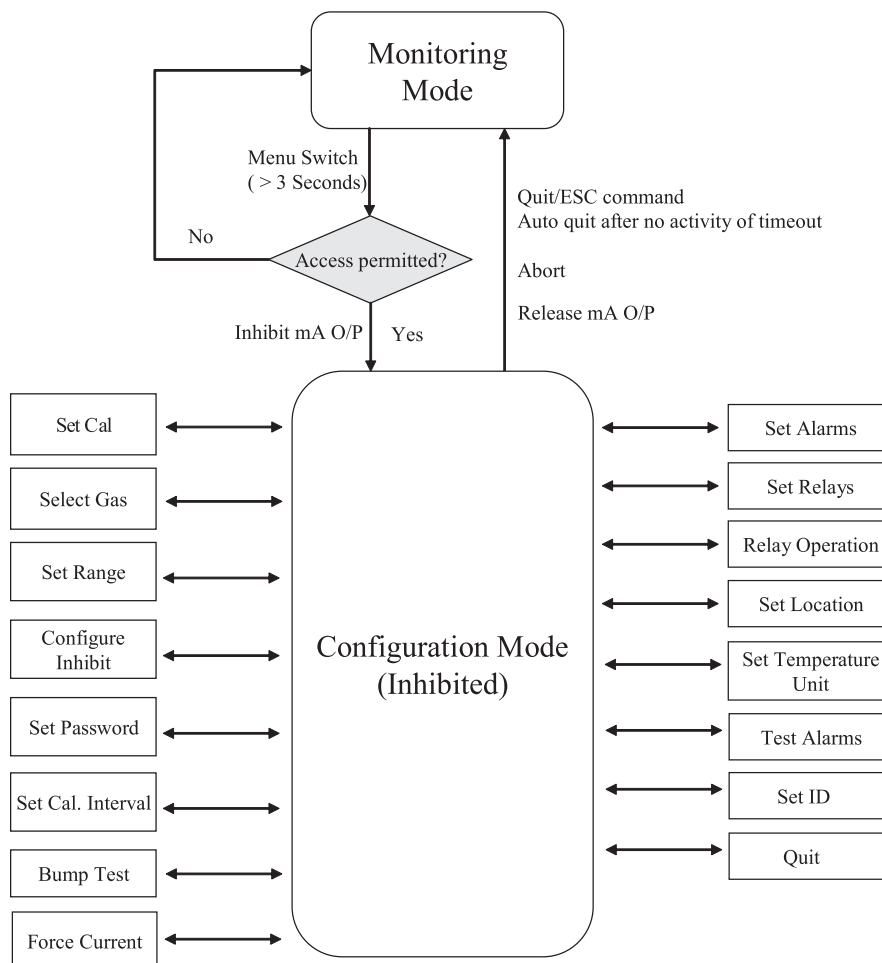
Use the table below to help navigate the menus and make configuration changes. The menus are shown in the left hand column. Use **▲▼** to select the required menu and **↵** to enter. Follow the information and instructions in the table from left to right from the required menu.

▲▼	OK	▲▼	OK	▲▼	OK	▲▼	OK	▲▼
SET CAL¹	✓	GAS NAME, ZERO CONCENTRATION AND FLASHING ICON DISPLAYED. APPLY ZERO GAS AND USE '↵' WHEN READING IS STABLE. IF THE READING WITH NO GAS APPLIED IS NOT ZERO THEN ADJUST THE SPAN POTENTIOMETER TO OBTAIN A ZERO GAS CONCENTRATION INDICATION.	↵	'SPAN' DISPLAYED AND 'YES' FLASHING TO ASK IF YOU NOW WANT TO PERFORM SPAN CALIBRATION. USE '↵' TO PROCEED OR USE ▲▼ TO SELECT 'No' AND RETURN TO MENU MODE.	✓	'GAS' TARGET CONCENTRATION FLASHING AND ICON DISPLAYED. USE ▲▼ TO CHANGE GAS CONCENTRATION AND '↵' TO START SPAN CALIBRATION. IF THE READING WITH SPAN GAS APPLIED IS NOT SPAN READING THEN ADJUST THE SPAN POTENTIOMETER TO OBTAIN A SPAN GAS CONCENTRATION INDICATION.	OK	GAS NAME, CURRENT CONCENTRATION AND FLASHING ICON DISPLAYED. APPLY SPAN GAS AND USE '↵' WHEN READING IS STABLE. IF OK 'PurG' DISPLAYED. REMOVE SPAN GAS. WHEN READING <50% OF SPAN POINT, COUNTDOWN BEGINS & UNIT RETURNS TO MENU MODE.
SEL 9AS	✓	'9AS' DISPLAYED WITH GAS TYPE DISPLAYED. USE ▲▼ TO SELECT DIFFERENT GAS.	✓	IF GAS TYPE IS CHANGED, 'CAL YES' DISPLAYED TO ASK IF YOU NOW WANT TO PERFORM CALIBRATION. USE '↵' TO PROCEED OR USE ▲▼ TO SELECT 'No' AND RETURN TO MENU MODE.	✓			
SET rAn9	✓	BAR GRAPH INDICATING CURRENT RANGE, 'rAn9' DISPLAYED & CURRENT RANGE FLASHES. USE ▲▼ TO SELECT DIFFERENT RANGE.	✓	IF RANGE IS CHANGED, 'CAL' DISPLAYED AND 'YES' FLASHING TO ASK IF YOU NOW WANT TO PERFORM CALIBRATION. USE '↵' TO PROCEED OR USE ▲▼ TO SELECT 'No'.	✓		IF RANGE IS CHANGED, 'ALrm' DISPLAYED AND 'YES' FLASHING TO ASK IF YOU NOW WANT TO MODIFY ALARM SETTINGS. USE '↵' TO PROCEED OR USE ▲▼ TO SELECT 'No' AND RETURN TO MENU MODE.	UNIT RETURNS TO MENU MODE.
Conf Inhb	✓	'Inhb' DISPLAYED WITH ICON FLASHING. CURRENT INHIBIT mA VALUE FLASHES. USE ▲▼ TO SELECT NEW VALUE (2 OR 4mA TOXICS, OR 2 OR 17.4mA OXYGEN VERSION).	✓	'Inhb' DISPLAYED WITH ICON FLASHING. CURRENT INHIBIT PERIOD (MINUTES) FLASHES. USE ▲▼ TO SET NEW TIMEOUT. (IF SET TO 0 OUTPUT IS PERMANENTLY INHIBITED).	✓			UNIT RETURNS TO MENU MODE.
SET PASS	✓	'PASS' DISPLAYED WITH FIRST DIGIT, PLACE ICON OF THE PASSCODE FLASHING. USE ▲ TO SELECT 1ST DIGIT OF CURRENT PASSWORD. USE ▼ TO MOVE TO NEXT DIGIT AND SET REST OF PASSCODE.	✓	UNIT RETURNS TO MENU MODE.	✓			
Forc Curr	✓	'Forc' DISPLAYED WITH ICON. DEFAULT FORCE CURRENT '4.00' FLASHES. USE ▲▼ TO CHANGE TO REQUIRED mA LEVEL.	✓	UNIT TRANSMITS THE CURRENT IF YOU WANT TO EXIT FROM THIS MENU. USE ABORT FUNCTION.	✓			
CAL Int³	✓	'Int' DISPLAYED WITH CURRENT CALIBRATION INTERVAL FLASHING. USE ▲▼ TO CHANGE INTERVAL.	✓	'due' DISPLAYED AND 'No', 'LOd' OR 'ALL' FLASHING. USE ▲▼ TO SELECT REQUIRED CAL DUE TO WARNING OUTPUT.	✓			UNIT RETURNS TO MENU MODE.







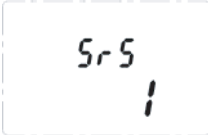

bump tEst	✓	PEAK READING DISPLAYED WITH OUTPUT INHIBITED. ICON AND PEAK STRING FLASHING. APPLY BUMP TEST GAS AND CHECK PEAK READING ON DISPLAY.	✓	CURRENT GAS CONCENTRATION DISPLAYED WITH OUTPUT INHIBITED. ICON FLASHING.	✓	UNIT RETURNS TO MENU MODE. WARNING: DO NOT RETURN TO NORMAL MODE UNTIL CURRENT GAS CONCENTRATION HAS FALLEN BELOW AT LIMIT OR THE DETECTOR WILL GIVE AN ALARM.		
Set ALrm	✓	'AL1', ICON DISPLAYED AND CURRENT ALARM LEVEL 1 CONCENTRATION FLASHES. USE ▲▲ TO CHANGE TO REQUIRED CONCENTRATION LEVEL.	✓	'AL1' DISPLAYED WITH 'None', 'HSE' OR 'FALL' FLASHING. USE ▲▲ TO SELECT REQUIRED ALARM FUNCTION.	✓	'AL2', ICON DISPLAYED AND CURRENT ALARM LEVEL 2 CONCENTRATION FLASHES. USE ▲▲ TO CHANGE TO REQUIRED CONCENTRATION LEVEL.	✓	'AL2' DISPLAYED WITH 'None', 'HSE' OR 'FALL' FLASHING. USE ▲▲ TO SELECT REQUIRED ALARM ACTION AND USE ✓ TO RETURN TO MENU MODE.
Set rLY	✓	'AL1' DISPLAYED AND 'AL1', 'AL2', 'Inrt' OR 'FL' FLASHES. USE ▲▲ TO CHANGE TO REQUIRED RELAY TARGET.	✓	'AL1' DISPLAYED AND 'dEEn' OR 'Em9' FLASHES. USE ▲▲ TO CHANGE TO REQUIRED RELAY ACTION.	✓	'R12' DISPLAYED AND 'AL1', 'AL2', 'Inrt' OR 'FL' FLASHES. USE ▲▲ TO CHANGE TO REQUIRED RELAY TARGET.	✓	'AL2' DISPLAYED AND 'dEEn' OR 'Em9' FLASHES. USE TO CHANGE TO REQUIRED RELAY ACTION.
rLY OPPr	✓	'AL3' DISPLAYED AND 'AL1', 'AL2', 'Inrt' OR 'FL' FLASHES. USE ▲▲ TO CHANGE TO REQUIRED RELAY TARGET.	✓	'AL3' DISPLAYED AND 'dEEn' OR 'Em9' FLASHES. USE ▲▲ TO CHANGE TO REQUIRED RELAY ACTION.	✓	UNIT RETURNS TO MENU MODE.		
Set Loc	✓	'LY', 'ON' DISPLAYED AND CURRENT RELAY-ON TIME FLASHES. USE ▲▲ TO CHANGE TO REQUIRED RELAY-ON DELAY.	✓	'LY', 'OFF' DISPLAYED AND CURRENT RELAY-OFF TIME FLASHES. USE ▲▲ TO CHANGE TO REQUIRED RELAY-OFF DELAY.	✓	'Lch' DISPLAYED AND 'YES' OR 'No' FLASHES. USE ▲▲ TO CHANGE TO REQUIRED LATCH OPTION.	✓	UNIT RETURNS TO MENU MODE.
tEmp Unit	✓	'Loc' DISPLAYED WITH FIRST 4 CHARACTERS OF THE LOCATION STRING. USE ▼ TO CHANGE THE 1ST CHARACTER OF CURRENT LOCATION STRING. USE ▲ TO MOVE TO NEXT CHARACTER AND SET REST OF STRING. MAXIMUM 12 CHARACTERS CAN BE SET.	✓	'Loc' DISPLAYED NEW LOCATION STRING. THE STRING MOVES RIGHT-TO-LEFT TO SHOW WHOLE CHARACTERS TWICE. THEN THE UNIT AUTOMATICALLY RETURN TO MENU MODE.				
tEst ALrm	✓	'tEmp' DISPLAYED WITH '°C' OR '°F' FLASHING. USE ▲▲ TO CHANGE TO REQUIRED TEMPERATURE UNIT.	✓	UNIT RETURNS TO MENU MODE.				
Set id	✓	'Forc' DISPLAYED AND 'AL1' FLASHING TO SELECT TEST-REQUIRED ALARM. USE ✓ TO FORCE ALARM.	✓	GAS NAME, CURRENT GAS CONCENTRATION DISPLAYED AND ICON AND AL ICON FLASHES.	✓	UNIT RETURNS TO MENU MODE.		
Quit	✓	'id' DISPLAYED WITH CURRENT DEVICE ID FLASHING. USE ▲▲ TO CHANGE DEVICE ID.	✓	'Bad' DISPLAYED AND '19k', OR '9600' FLASHING. USE ▲▲ TO SELECT REQUIRED BADRATE.			✓	'PArY' DISPLAYED AND 'EIEH', 'Odd' OR 'None' FLASHING. USE ▲▲ TO SELECT REQUIRED PARTY.
▲▲	OK	QUITS MENU MODE AND RETURNS TO MONITORING MODE.	OK	▲▲	OK	▲▲	OK	▲▲

¹ Refer to section 10.1 for detailed zero and span calibration procedures. A detector fitted with an oxygen sensor will skip the zeroing
² The calibration due warning counter is automatically reset after a successful calibration.

13.3 Review Mode

The instrument will enter Review mode when the “Enter” switch is activated with the Magnetic Wand and held for around one second.

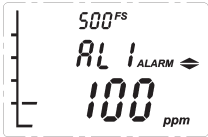
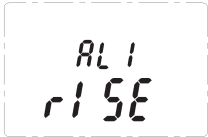
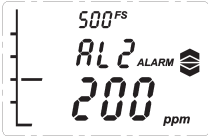
Names, displays and descriptions for each review item in Review Mode are shown in the following table.

Item name	Display	Description
Software version		S/W version of transmitter
SRS version		S/W version of SRS (watch dog)
EEP version		EEPROM parameter version
Gas		Gas type
Measuring range		A user selected measuring range
Calibration level		Calibration gas level
Calibration due		Estimated time to next calibration
Alarm 1	 	Alarm settings for Alarm 1
Alarm 2	 	Alarm settings for Alarm 2







Location		Location in which the transmitter is installed
Power		Power voltage*
mA input value		mA input signal from the sensor.
Temperature		Internal Transmitter temperature*
Peak conc.		Maximum concentration detected up to now
Test Result		There is no fault detected.

Table 10: Transmitter menu descriptions

Note:

*Power voltage and internal transmitter temperature may be different from actual value due to measuring accuracy and internal heating components.

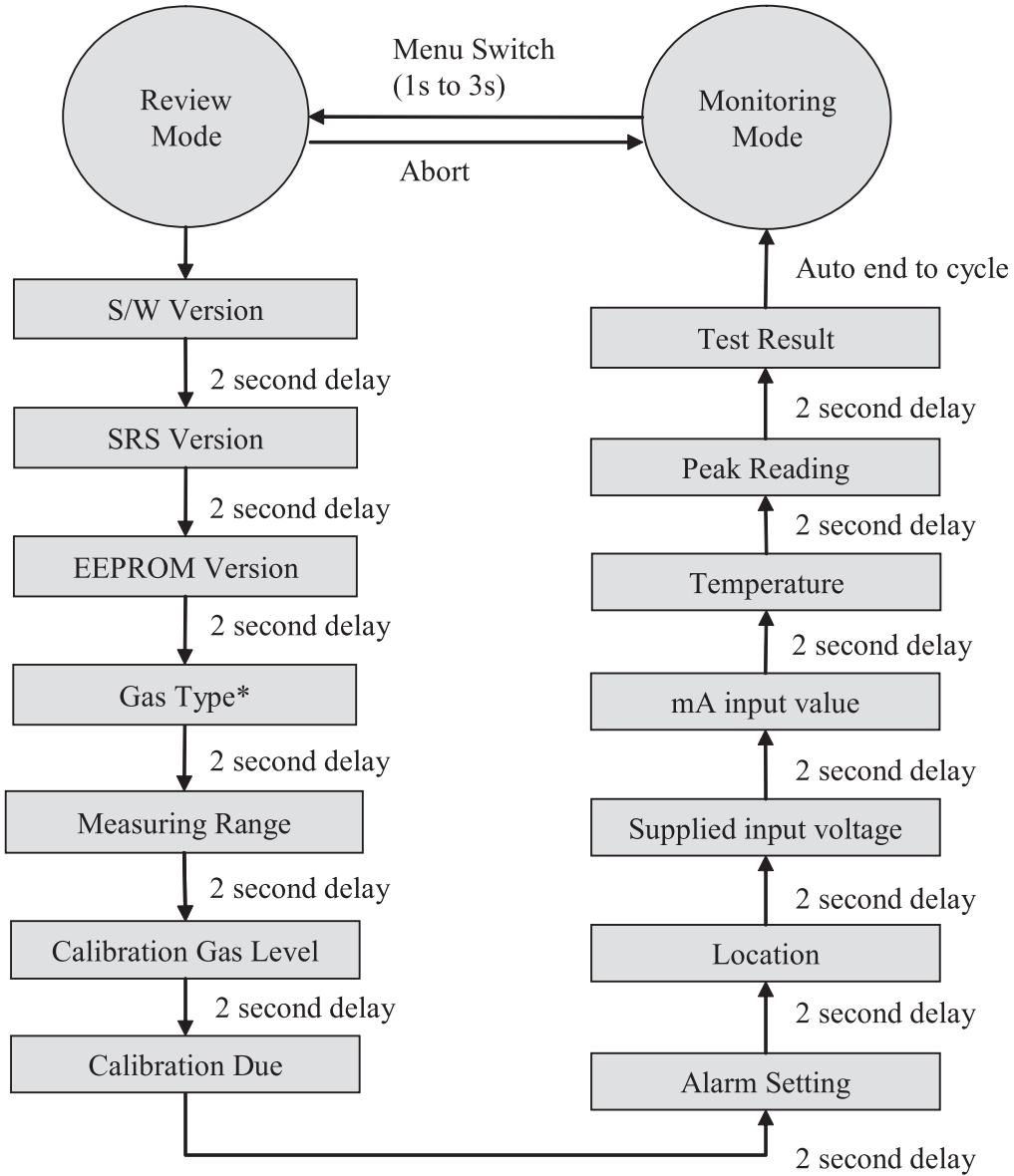

***Note:**
The default gas type is “CO” and the default measuring range is 100ppm.

Diagram 17: Review Mode

14 General specification

Sensepoint XCD Transmitter							
Use	3-wire, 4-20mA, gas detector transmitter for use with toxic gas sensors. For the protection of personnel and plant from toxic hazards.						
Electrical							
	Input Voltage Range: Max Power Consumption: Current output ≥0.0<1.0 mA 4.0 mA to 20.0 mA 2.0 mA or 4.0 mA (17.4 mA) 22.0 mA Terminals Relays Communication	16 to 32Vdc (24Vdc nominal) Max 5 Watts. at 24Vdc (see section 2 regarding maximum in rush current) 4-20mA (Source or Sink) Fault (refer to table 5 section 12.3 for further details) Normal gas measurement Inhibit (during configuration/user settings) Maximum over range 18 x screw terminals suitable for wire diameter 0.5mm ² to 2.5mm ² (20AWG to 13AWG). 3 x 5A@250VAC. Selectable normally open or normally closed (switch) and energized/ de-energized (programmable). RS485, Modbus RTU					
Construction							
Material	Epoxy painted aluminium alloy or 316 Stainless Steel						
Weight	Aluminium alloy: 2.0kg, 316 Stainless Steel: 4.5kg						
Mounting	Pole or wall mounting						
Entries	2 x M20 (for ATEX/IECEX/AP Approval) or 2 x 3/4NPT (for cCSAus Approval)						
Detectable Gases & Performance (See notes below)							
Gas Name	Displayed Name	Range	Lower Alarm	Lower Alarm Type	Higher Alarm	Higher Alarm Type	Lowest Alarm Level
Hydrogen Sulphide	H ₂ S	20.0 ppm	4.0 ppm	Rising	8.0 ppm	Rising	2.0 ppm
		50.0 ppm	10.0 ppm	Rising	20.0 ppm	Rising	5.0 ppm
		100 ppm	20 ppm	Rising	40 ppm	Rising	10 ppm
Carbon Monoxide	CO	100 ppm	30 ppm	Rising	60 ppm	Rising	10 ppm
		200 ppm	40 ppm	Rising	80 ppm	Rising	20 ppm
		500 ppm	100 ppm	Rising	200 ppm	Rising	50 ppm
Chlorine	Cl ₂	5.0 ppm	0.5 ppm	Rising	2.0 ppm	Rising	0.5 ppm
		15.0 ppm	1.5 ppm	Rising	6.0 ppm	Rising	1.5 ppm
Ammonia	NH ₃	50.0 ppm	20.0 ppm	Rising	30.0 ppm	Rising	5.0ppm
		100 ppm	20 ppm	Rising	40 ppm	Rising	10 ppm
		1000 ppm	200 ppm	Rising	400 ppm	Rising	100 ppm
Hydrogen	H ₂	1000 ppm	200 ppm	Rising	400 ppm	Rising	100 ppm
	H ₂	9999 ppm	2000 ppm	Rising	4000 ppm	Rising	1000 ppm
Nitrogen Monoxide	NO	100 ppm	20 ppm	Rising	40 ppm	Rising	10 ppm
Sulphur Dioxide	SO ₂	15.0 ppm	2.0 ppm	Rising	6.0 ppm	Rising	1.5 ppm
	SO ₂	50.0 ppm	5.0 ppm	Rising	20.0 ppm	Rising	5.0 ppm
Nitrogen Dioxide	NO ₂	10.0 ppm	2.0 ppm	Rising	4.0 ppm	Rising	1.0 ppm
Oxygen	O ₂	25.0% V/V	19.5%Vol	Falling	23.5%Vol	Rising	10.0%Vol
NOTES Please refer Sensepoint Technical Handbook for detail.							
Certification							
China	GB Ex d IIC T4 GB3836.1&2 -2000, PA						
Korea	KTL Ex d IIC T6 (-40°C to +65°C)						
European	ATEX Ex II 2 GD Ex d IIC Gb T6(Ta -40°C to +65°C) Ex tb IIIC T85°C Db IP66						
International	IEC Ex d IIC Gb T6(Ta -40°C to +65°C) Ex tb IIIC T85°C Db IP66						
North America	cCSAus Ex d IIB+H2; Class I, Division 2, Group B, C and D						
CE	EN50270:2015						
Environmental							
IP Rating	IP66 in accordance with EN60529:1992, NEMA 4X						
Operating Temperature	-40°C to +65°C/ -40°F to +149°F <i>Note: The detector display may become illegible at temperatures below -40°C, but the detector continues its gas monitoring function. The display is not damaged and recovers when the temperature rises back above -20 °C. Sensor operating temperature range is dependent on gas type. Please refer to the Sensepoint Technical Handbook for details.</i>						
Operating Humidity	Continuous 20-90%RH (non condensing), Intermittent 10-99%RH (non condensing)						
Operating Pressure	90-110kPa						
Storage Conditions	-25°C to +65°C (-13°F to +149°F)						

15 Ordering information

Part number	Description
Sensepoint XCD RTD 4-20mA Input Transmitter (Select required Sensepoint Toxic Sensor from below).	
SPXCDASMTX4	ATEX, IECEx & AP approved SP XCD RTD 4-20mA Input Transmitter with 316SS, M20 Entry, without MODBUS
SPXCDALMTX4	ATEX, IECEx & AP approved SP XCD RTD 4-20mA Input Transmitter with LM25, M20 Entry, without MODBUS
SPXCDUSNTX4	cCSAus approved SP XCD RTD 4-20mA Input Transmitter with 316SS, 3/4"NPT Entry, without MODBUS
SPXCDULNTX4	cCSAus approved SP XCD RTD 4-20mA Input Transmitter with LM25, 3/4"NPT Entry, without MODBUS
SPXCDASMTX4M	ATEX, IECEx & AP approved SP XCD RTD 4-20mA Input Transmitter with 316SS, M20 Entry, with MODBUS
SPXCDALMTX4M	ATEX, IECEx & AP approved SP XCD RTD 4-20mA Input Transmitter with LM25, M20 Entry, with MODBUS
SPXCDUSNTX4M	cCSAus approved SP XCD RTD 4-20mA Input Transmitter with 316SS, 3/4"NPT Entry, with MODBUS
SPXCDULNTX4M	cCSAus approved SP XCD RTD 4-20mA Input Transmitter with LM25, 3/4"NPT Entry, with MODBUS
Sensepoint Toxic Sensor	
2106B1500	ATEX Approved Sensepoint H2S 0-20 ppm Toxic Sensor M25
2106B1501	ATEX Approved Sensepoint H2S 0-50 ppm Toxic Sensor M25
2106B1502	ATEX Approved Sensepoint H2S 0-100 ppm Toxic Sensor M25
2106B1505	ATEX Approved Sensepoint CO 0-100 ppm Toxic Sensor M25
2106B1506	ATEX Approved Sensepoint CO 0-200 ppm Toxic Sensor M25
2106B1507	ATEX Approved Sensepoint CO 0-500 ppm Toxic Sensor M25
2106B1510	ATEX Approved Sensepoint Cl2 0-5 ppm Toxic Sensor M25
2106B1511	ATEX Approved Sensepoint Cl2 0-15 ppm Toxic Sensor M25
2106B1513	ATEX Approved Sensepoint NH3 0-50 ppm Toxic Sensor M25
2106B1514	ATEX Approved Sensepoint NH3 0-1000 ppm Toxic Sensor M25
2106B1515	ATEX Approved Sensepoint NH3 0-100 ppm Toxic Sensor M25
2106B1516	ATEX Approved Sensepoint H2 0-1000 ppm Toxic Sensor M25
2106B1517	ATEX Approved Sensepoint H2 0-10000 ppm Toxic Sensor M25
2106B1518	ATEX Approved Sensepoint NO 0-100 ppm Toxic Sensor M25
2106B1520	ATEX Approved Sensepoint SO2 0-15 ppm Toxic Sensor M25
2106B1521	ATEX Approved Sensepoint SO2 0-50 ppm Toxic Sensor M25
2106B1522	ATEX Approved Sensepoint NO2 0-10 ppm Toxic Sensor M25
2106B1530	ATEX Approved Sensepoint O2 25% V/V Toxic Sensor M25
2106B1800	cCSAus Approved Sensepoint H2S 0-20 ppm Toxic Sensor 3/4NPT
2106B1801	cCSAus Approved Sensepoint H2S 0-50 ppm Toxic Sensor 3/4NPT
2106B1802	cCSAus Approved Sensepoint H2S 0-100 ppm Toxic Sensor 3/4NPT
2106B1805	cCSAus Approved 0-100 ppm Toxic Sensor 3/4NPT
2106B1806	cCSAus Approved 0-200 ppm Toxic Sensor 3/4NPT
2106B1807	cCSAus Approved 0-500 ppm Toxic Sensor 3/4NPT
2106B1810	cCSAus Approved Sensepoint Cl2 0-5 ppm Toxic Sensor 3/4NPT
2106B1811	cCSAus Approved Sensepoint Cl2 0-15 ppm Toxic Sensor 3/4NPT
2106B1813	cCSAus Approved Sensepoint NH3 0-50 ppm Toxic Sensor 3/4NPT
2106B1814	cCSAus Approved Sensepoint NH3 0-1000 ppm Toxic Sensor 3/4NPT
2106B1815	cCSAus Approved Sensepoint NH3 0-100 ppm Toxic Sensor 3/4NPT
2106B1816	cCSAus Approved Sensepoint H2 0-1000 ppm Toxic Sensor 3/4NPT
2106B1817	cCSAus Approved Sensepoint H2 0-10000 ppm Toxic Sensor 3/4NPT
2106B1818	cCSAus Approved Sensepoint NO 0-100 ppm Toxic Sensor 3/4NPT
2106B1820	cCSAus Approved Sensepoint SO2 0-15 ppm Toxic Sensor 3/4NPT
2106B1821	cCSAus Approved Sensepoint SO2 0-50 ppm Toxic Sensor 3/4NPT
2106B1822	cCSAus Approved Sensepoint NO2 0-10 ppm Toxic Sensor 3/4NPT

2106B1830	cCSAus Approved Sensepoint O2 25% V/V Toxic Sensor 3/4NPT
Accessories	
SPXCMTBR	Mounting bracket (inc. bolts, nuts, brackets)
SPXCSDP	Sunshade / Deluge Protection
Spares	
SPXCMT4	Replacement terminal module for RTD (4~20mA)
SPXCDDM4	Replacement display module for RTD (4~20mA)
SPXCMM20P	M20 blanking plug
SPXCDHMRTEN	Instruction manual CD
SPXCMMAG	Magnet
SPXCDAKS	Allen key for stopper
SPXCDDWES	Hex wrench for earth screw
SPXCDEBS	Earth Bracket and Screws

16 Warranty statement

All products are designed and manufactured to the latest internationally recognized standards by Honeywell Analytics under a Quality Management system that is certified to ISO 9001. As such Honeywell Analytics warrants its products against defective parts and workmanship and will repair or (at its option) replace any instruments which are or may become defective under proper use within 12 months from date of commissioning by an approved Honeywell Analytics representative or 18 months from date of shipment from Honeywell Analytics, whichever is the sooner. This warranty does not cover disposable batteries or damage caused by accident, abuse, abnormal operating conditions or poisoning of sensor.

Defective goods must be returned to Honeywell Analytics premises accompanied by a detailed description of any issue. Where return of goods is not practicable Honeywell Analytics reserves the right to charge for any site attendance where any fault is not found with the equipment. Honeywell Analytics shall not be liable for any loss or damage whatsoever or howsoever occasioned which may be a direct or indirect result of the use or operation of the Contract Goods by the Buyer or any Party.

This warranty covers instrument and parts sold to the Buyer only by authorized distributors, dealers and representatives as appointed by Honeywell Analytics. The warranties set out in this clause are not pro rata, i.e. the initial warranty period is not extended by virtue of any works carried out there under.

In no event will Honeywell Analytics be liable for any incidental damages, consequential damages, special damages, punitive damages, statutory damages, indirect damages, loss of profits, loss of revenues, or loss of use, even if informed of the possibility of such damages. Honeywell Analytic's liability for any claims arising out of or related to this product will in no case exceed the order value. To the extent permitted by applicable law, these limitations and exclusions will apply regardless of whether liability arises from breach of contract, warranty, tort (including but not limited to negligence), by operation of law, or otherwise.

17 Installation Drawing

17.1 Mechanical Installation Drawing

3001G0496 SHT. 1

THIS DOCUMENT HAS BEEN GENERATED USING AutoCAD AND MUST ONLY BE UPDATED BY C.A.D.

Horizontal Pipe Mounted

Wall Mounted

THIS ITEM FORMS PART OF A CERTIFIED PRODUCT
NO MODIFICATION PERMITTED WITHOUT
REFERENCE TO CERTIFICATION DEPARTMENT

Vertical Pipe Mounted

SCALE: SA 2009-07-17

TITLE: Sensepoint XCD RTD Transmitter Installation Drawing

3001G0496 .SHT.1 OF 4

THIS DRAWING IS CONFIDENTIAL. IT IS THE PROPERTY OF HONEYWELL ANALYTICS LTD AND MUST NOT BE REPRODUCED EITHER WHOLLY OR PARTLY. ALL RIGHTS IN RESPECT OF PATENTS, DESIGNS AND COPYRIGHT ARE RESERVED.

TOLERANCES TO BE AS SPECIFIED BELOW UNLESS OTHERWISE STATED.

DIMS.

2 DP ± 0.1 mm
1 DP ± 0.25 mm
NONE ± 0.4 mm
ANGULAR ± 1/2

HOLES.

Ø 0 to 8 + 0.08
Ø 8 to 14 + 0.1
Ø 14 to 25 + 0.12
Ø 25 to 50 + 0.2

ALL DIMENSIONS IN MILLIMETRES UNLESS OTHERWISE STATED. AND APPLY AFTER PLATING

THIS DRAWING IS TO BS 8886

REMOVE ALL BURRS AND SHARP EDGES

SURFACE TEXTURE VALUES ARE IN µm Ra AND TO BS 1134

FINISH	J	I	H	G	F	E	D	C	B	K	ISSUE
20JUL10	13NOV09	12NOV09	09NOV09	09NOV09	09NOV09	29OCT09	27OCT09	27OCT09	08OCT09	21SEP11	DATE
Modify Sheet	Change Note	Change Note	Change Note	Change Note	Change Note	Remove Adaptor	Change Title	Add Sheet	Change Voltage	Jeffrey	CHANGE
J.Y.JIN	J.Y.JIN	J.Y.JIN	J.Y.JIN	J.Y.JIN	J.Y.JIN	J.Y.JIN	J.Y.JIN	J.Y.JIN	J.Y.JIN	J.Y.JIN	APPD

I. SPECIFICATION

1. SIZE: 164 X 217 X 99

2. MATERIAL

A. TRANSMITTER: LM25 / 316SS

B. MOUNTING BRACKET: 316SS

3. WEIGHT: 2kg / 4.5kg

A. TRANSMITTER(LM25): 1.8kg

B. TRANSMITTER(316SS): 4.3kg

C. MOUNTING BRACKET: 0.2kg

II. HAZARDOUS CERTIFICATION

1. ATEX

II 2 GD

Ex d IIC Gb T6(Ta -40 °C to +65 °C)

Ex tb IIIC T85 °C Db IP66

Baseefa08ATEX0222

2. KTL

Ex d IIC T6, 16~32Volts DC, Pmax=5W

Tamb. -40 °C to +65 °C

3. GB, PA

III. ITEM LIST

1. XCD RTD TRANSMITTER

2. SENSE POINT TOXIC DETECTOR

3. PIPE MOUNTING BRACKET

17.2 Electronic Connection Drawing

3001G0496

SHT. 2

THIS DOCUMENT HAS BEEN GENERATED USING AutoCAD AND MUST ONLY BE UPDATED BY C.A.D.



Controller & Transmitter with Relays

3 Wire 4~20mA (Source) with Relays

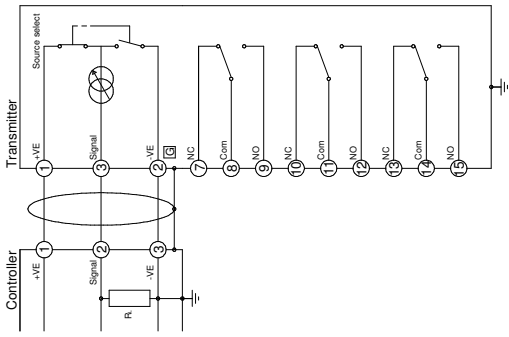

Controller & Transmitter with Relays

3 Wire 4~20mA (Sink) with Relays

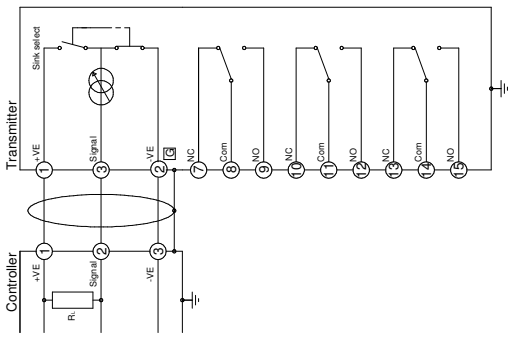

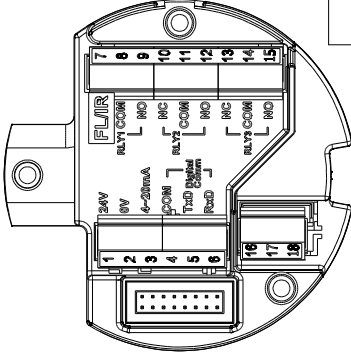

TERMINAL NO.	FUNCTION
1	+24V DC (16~32VDC)
2	0 V
3	4~20mA (signal)
4	TBD
5	TBD
6	TBD
7	RLY 1 NC
8	RLY 1 COM
9	RLY 1 NO
10	RLY 2 NC
11	RLY 2 COM
12	RLY NO
13	RLY 3 NC
14	RLY 3 COM
15	RLY 3 NO
16	+24V DC
17	4~20 mA (signal)
18	-

NOTES:

- REFER TO INSTRUCTION MANUAL FOR TECHNICAL DETAILS.
- XCD OPERATING VOLTAGE 16~32Volts DC, 5W(Max)
- 4~20 mA LOOP RESISTANCE TO BE < 300 ohms
- POWER SUPPLY LOOP RESISTANCE TO BE < 12 ohm
- NO TWO 'EARTH POINTS' SHOULD BE CONNECTED VIA SCREEN AND/OR CONDUIT SO AS TO AVOID 'GROUND LOOPS'.
- MULTIPLE 'EARTH POINTS' ARE NOT ALLOWED.
- 'IGT POINTS' (CONTINUITY OF SCREEN) MAY BE ACHIEVED USING APPROPRIATE GLANDS/CABLE OR CONDUIT; INTERNAL AND EXTERNAL 'EARTH POINTS' IN THE TRANSMITTER ARE PROVIDED.

THIS ITEM FORMS PART OF A CERTIFIED PRODUCT NO MODIFICATION PERMITTED WITHOUT REFERENCE TO CERTIFICATION DEPARTMENT

SCALE	DR'N	SA	2009-07-17
NTS	TITLE	Sensepoint XCD RTD Transmitter Installation Drawing	
ISSUE	DATE	20JUL10 13NOV09 12NOV09 09NOV09 02NOV09 23OCT09 27OCT09 08OCT09 21SEP11	
K	CHANGE	Changed Voltage	
B	Adt	Sheet	
C	Remove	Adapter	
D	Modify	Text	
E	Change	Range	
F	Change	Note	
G	Change	Note	
H	Change	Note	
I	Change	Note	
J	Change	Note	

FINISH	MATERIAL
J	
K	
L	
M	
N	
O	
P	
Q	
R	
S	
T	
U	
V	
W	
X	
Y	
Z	

ALL DIMENSIONS IN MILLIMETRES UNLESS OTHERWISE STATED. AND APPLY AFTER PLATING.

REMOVE ALL BURRS AND SHARP EDGES

SURFACE TEXTURE VALUES ARE IN um Ra AND TO BS 1134

FINISH: BS 8888

DIMS: 2 DP ± 0.1 mm, 1 DP ± 0.25 mm, NONE ± 0.4 mm, ANGULAR ± 1/2°

Holes: ø 0 to ø + 0.08, ø 0 to ø + 0.1, ø 8 to 14 + 0.12, ø 14 to 25 + 0.20



THIS DOCUMENT HAS BEEN GENERATED USING AutoCAD AND MUST ONLY BE UPDATED BY C.A.D.

3001G0496 SHT. 3

Transmitter & Detector

2 Wire 4~20mA (Source)

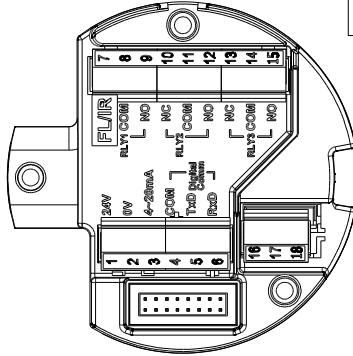
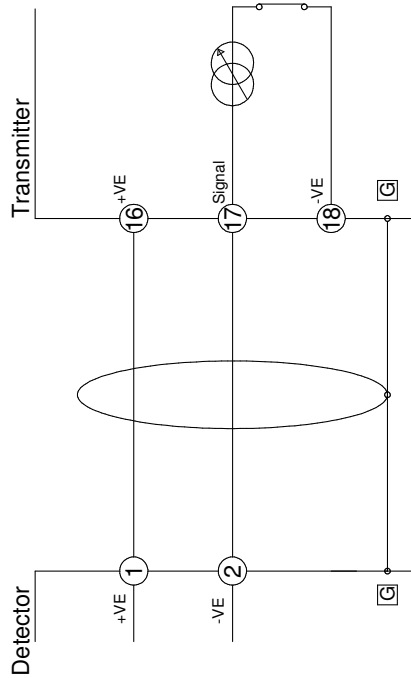

TERMINAL NO.	FUNCTION
1	+24V DC (16~32VDC)
2	0 V
3	4~20 mA (signal)
4	TBD
5	TBD
6	TBD
7	RLY1 NC
8	RLY1 COM
9	RLY1 NO
10	RLY2 NC
11	RLY2 COM
12	RLY2 NO
13	RLY3 NC
14	RLY3 COM
15	RLY3 NO
16	+24V DC
17	4~20 mA (signal)
18	-

THIS ITEM FORMS PART OF A CERTIFIED PRODUCT. NO MODIFICATION PERMITTED WITHOUT REFERENCE TO CERTIFICATION DEPARTMENT

- NOTES:**
- REFER TO INSTRUCTION MANUAL FOR TECHNICAL DETAILS.
 - XCD OPERATING VOLTAGE 16~32Volts DC, 5W(Max)
 - 4~20 mA LOOP RESISTANCE TO BE < 300 ohms
 - POWER SUPPLY LOOP RESISTANCE TO BE < 12 ohm
 - NO TWO 'EARTH POINTS' SHOULD BE CONNECTED VIA SCREEN AND/OR CONDUIT SO AS TO AVOID 'GROUND LOOPS'.
 - MULTIPLE 'EARTH POINTS' ARE NOT ALLOWED.
 - '[G] POINTS' (CONTINUITY OF SCREEN) MAY BE ACHIEVED USING APPROPRIATE GLANDS/CABLE OR CONDUIT; INTERNAL AND EXTERNAL 'EARTH POINTS' IN THE TRANSMITTER ARE PROVIDED.

FINISH		MATERIAL										SCALE		DRN TITLE			
J	I	H	G	F	E	D	C	B	K	NTS	ISSUE	DATE	CHANGE	APPD	SA	TITLE	
20JUL10	13NOV08	12NOV09	09NOV09	08NOV08	02NOV08	28OCT08	27OCT08	08OCT08	21SEP11							2009-07-17	Sensepoint XCD RTD Transmitter Installation Drawing
Modify Sheet4	Change Range	Change Note	Change Range	Change Note	Modify Text	Remove Adaptor	Change Title	Add Sheet4	Change Voltage								3001G0496
J.Y.JIN	J.Y.JIN	J.Y.JIN	J.Y.JIN	J.Y.JIN	J.Y.JIN	J.Y.JIN	J.Y.JIN	J.Y.JIN	J.Y.JIN	J.Y.JIN	J.Y.JIN	J.Y.JIN	J.Y.JIN	J.Y.JIN	J.Y.JIN	J.Y.JIN	Jeffrey

THIS DRAWING IS CONFIDENTIAL. IT IS THE PROPERTY OF HONEYWELL ANALYTICS LTD. AND MUST NOT BE REPRODUCED EITHER WHOLLY OR PARTLY. ALL RIGHTS IN RESPECT OF PATENTS, DESIGNS AND COPYRIGHT ARE RESERVED.

ALL DIMENSIONS IN MILLIMETRES UNLESS OTHERWISE STATED. AND APPLY AFTER PLATING. THIS DRAWING IS TO BS 8886. REMOVE ALL BURRS AND SHARP EDGES. SURFACE TEXTURE VALUES ARE IN µm Ra AND TO BS 1134

TOLERANCES TO BE AS SPECIFIED BELOW UNLESS OTHERWISE STATED.
 DIMS.
 1 DP ± 0.1 mm
 1 DP ± 0.25 mm
 NONE ± 0.4 mm
 ANGULAR ± 1/2°
 HOLES.
 Ø 0 to 8 + 0.08
 + 0.1
 Ø 8 to 14 - 0.0
 + 0.12
 Ø 14 to 25 - 0.0

17.3 Sensepoint XCD RTD Typical Installation Drawing

3001G0496

SHT. 4

Honeywell

THIS DOCUMENT HAS BEEN GENERATED USING AutoCAD AND MUST ONLY BE UPDATED BY C.A.D.

SCALE: SA 2009-07-17

Sensepoint RTD with Remote Sensepoint Toxic Sensor

THIS DRAWING IS CONFIDENTIAL. IT IS THE PROPERTY OF HONEYWELL ANALYTICS LTD. AND MUST NOT BE REPRODUCED EITHER WHOLLY OR PARTLY. ALL RIGHTS IN RESPECT OF PATENTS, DESIGNS AND COPYRIGHT ARE RESERVED.

TOLERANCES TO BE AS SPECIFIED BELOW UNLESS OTHERWISE STATED.
 DIMS. 1 DP ± 0.1 mm
 2 DP ± 0.25 mm
 NONE ± 0.4 mm
 ANGULAR ± 1/2°
 HOLES. Ø 0 to 8 + 0.08
 Ø 8 to 14 + 0.0
 Ø 14 to 25 + 0.12
 - 0.12
 - 0.0

ALL DIMENSIONS IN MILLIMETRES UNLESS OTHERWISE STATED. AND APPLY AFTER PLATING.
 THIS DRAWING IS TO BS RRRR
 REMOVE ALL BURRS AND SHARP EDGES
 SURFACE TEXTURE VALUES ARE IN µm Ra AND TO BS 1134

THIS ITEM FORMS PART OF A CERTIFIED PRODUCT. NO MODIFICATION PERMITTED WITHOUT REFERENCE TO CERTIFICATION DEPARTMENT.

FINISH		MATERIAL										SCALE	DR'N	TITLE					
J	I	H	G	F	E	D	C	B	K	NTS	ISSUE	DATE	CHANGE	APP'D					
Modify Sheet	Change Range	Change Note	Change Range	Change Note	Change Note	Modify Text	Remove Adaptor	Change Title	Add Sheet	Change Value	20JUL/10	13NOV/09	12NOV/09	06NOV/09	02NOV/09	29OCT/09	27OCT/09	08OCT/09	21SEP/11
J.Y. JIN	J.Y. JIN	J.Y. JIN	J.Y. JIN	J.Y. JIN	J.Y. JIN	J.Y. JIN	J.Y. JIN	J.Y. JIN	J.Y. JIN	J.Y. JIN	Jeffrey								

Sensepoint XCD RTD Transmitter Installation Drawing

3001G0496

SHT. 4 OF 4

17.4 Mounting Bolt Assy Drawing

3001A0416

SHT. 1

THIS DOCUMENT HAS BEEN GENERATED USING AutoCAD
AND MUST ONLY BE UPDATED BY C.A.D.

THIS ITEM FORMS PART OF A CERTIFIED PRODUCT
NO MODIFICATION PERMITTED WITHOUT
REFERENCE TO CERTIFICATION DEPARTMENT

MATERIAL: 316SS		SCALE: 2/1	DWN: BEN	DATE: 25/Oct/07
FINISH		TITLE: Mounting Bolt Assy		
1	D	C	B	A
05/NOV/08	21/AUG/08	07/JUL/08	24/JUN/08	25/OCT/07
J.Y.JIN	Washer Detail	J.Y.JIN	Change Length	NEW DRAWING
J.Y.JIN	J.Y.JIN	J.Y.JIN	J.Y.JIN	J.Y.JIN
APP'D	APP'D	APP'D	APP'D	APP'D
<p>ALL DIMENSIONS IN MILLIMETRES UNLESS OTHERWISE STATED. AND APPLY AFTER PLATING. THIS DRAWING IS TO BS 6866</p> <p>REMOVE ALL BURRS AND SHARP EDGES SURFACE TEXTURE VALUES ARE IN µm Ra AND TO BS 1134</p>				SHT. 1
<p>TOLERANCES TO BE AS SPECIFIED BELOW UNLESS OTHERWISE STATED.</p> <p>DIMS.</p> <p>2 DP ± 0.1 mm</p> <p>1 DP ± 0.25 mm</p> <p>NONE ± 0.4 mm</p> <p>ANGULAR ± 1/2°</p> <p>Holes.</p> <p>Ø 0 to Ø + 0.08</p> <p>Ø 0 to 14 + 0.0</p> <p>Ø 8 to 14 + 0.1</p> <p>Ø 14 to 25 + 0.2</p>				OF
<p>THIS DRAWING IS CONFIDENTIAL. IT IS THE PROPERTY OF HONEYWELL ANALYTICS LTD. AND MUST NOT BE REPRODUCED EITHER WHOLLY OR PARTLY. ALL RIGHTS IN RESPECT OF PATENTS, DESIGNS AND COPYRIGHT ARE RESERVED.</p>				3001A0416

17.5 Mounting Bracket Drawing

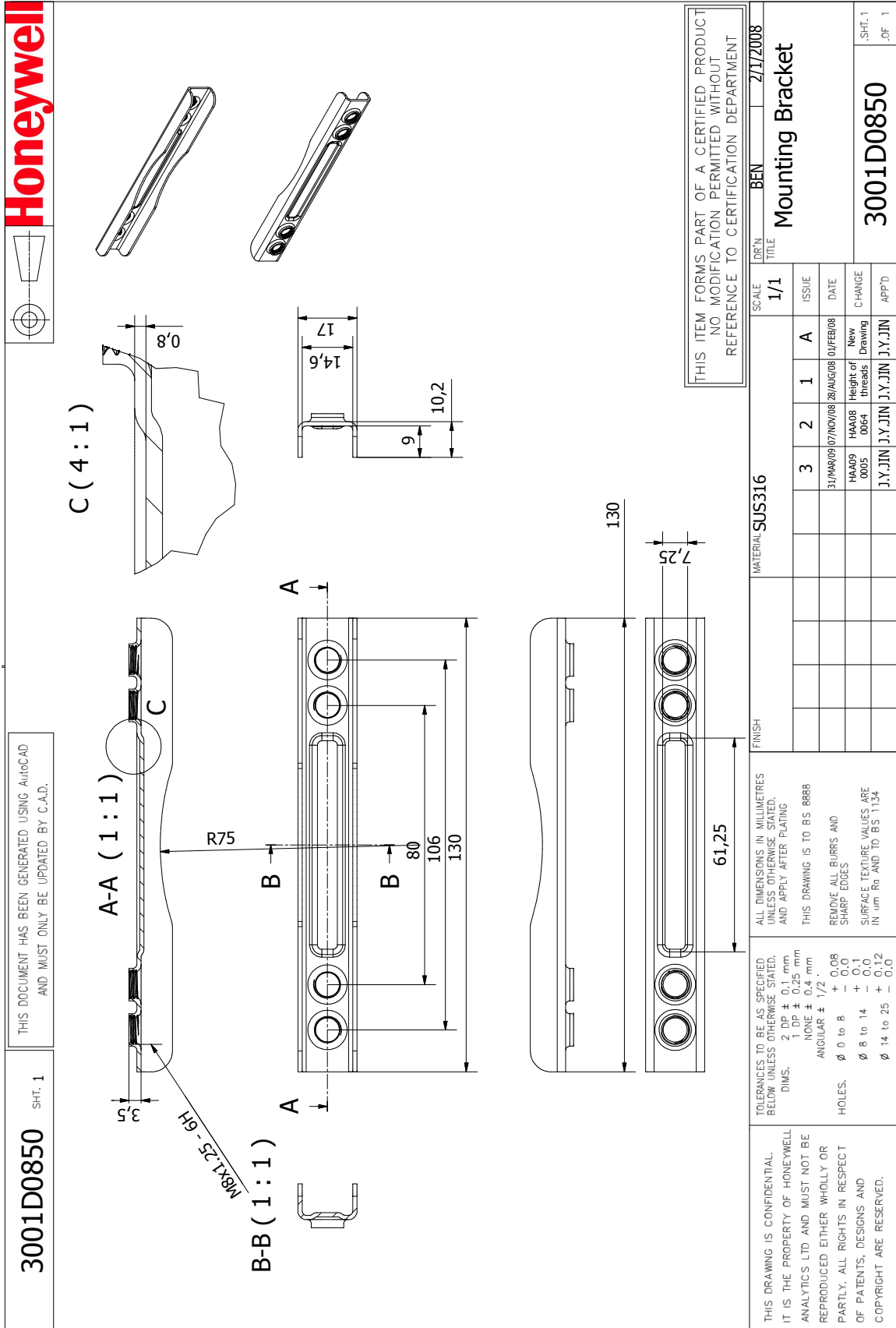

17.6 Control Drawing

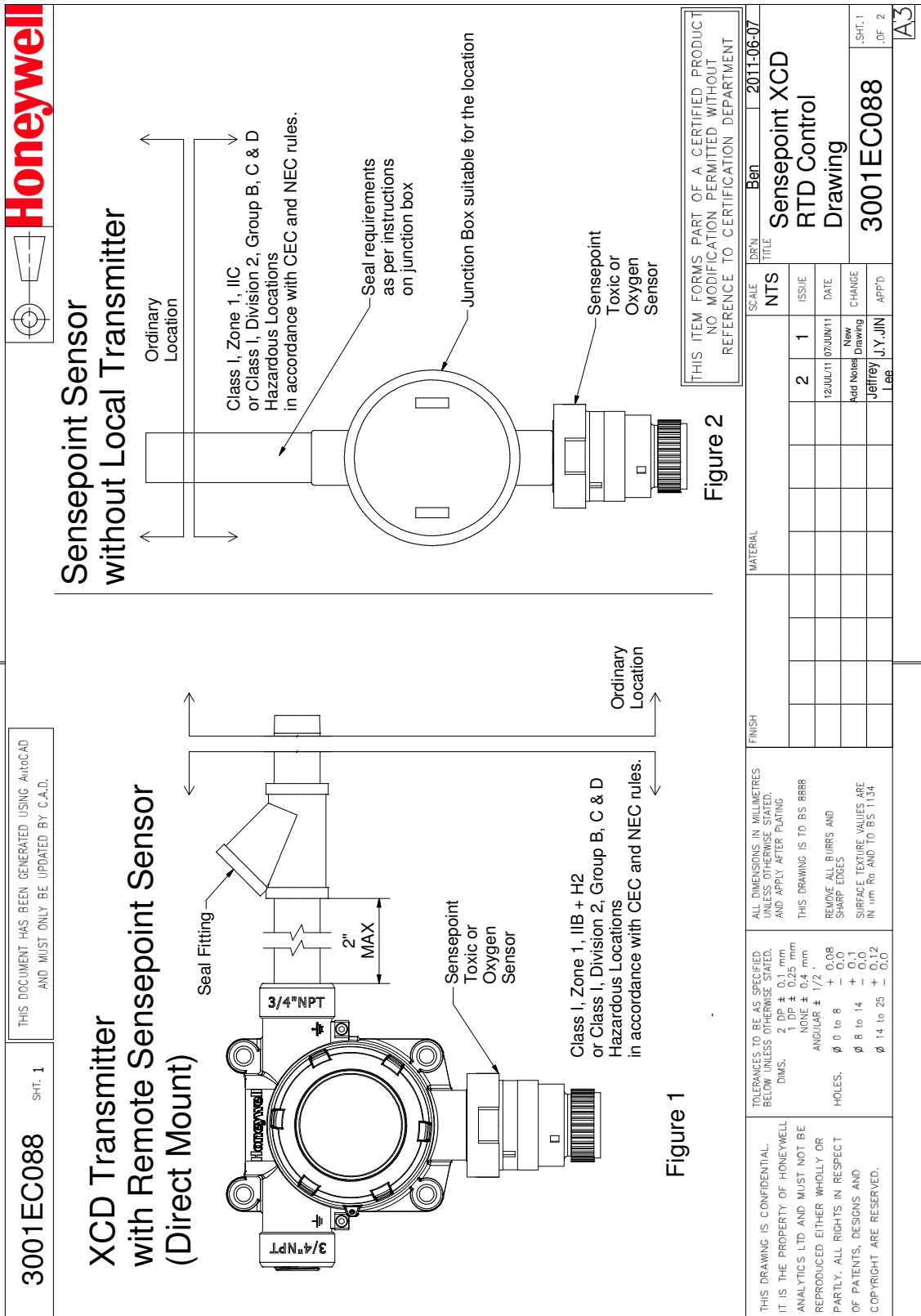

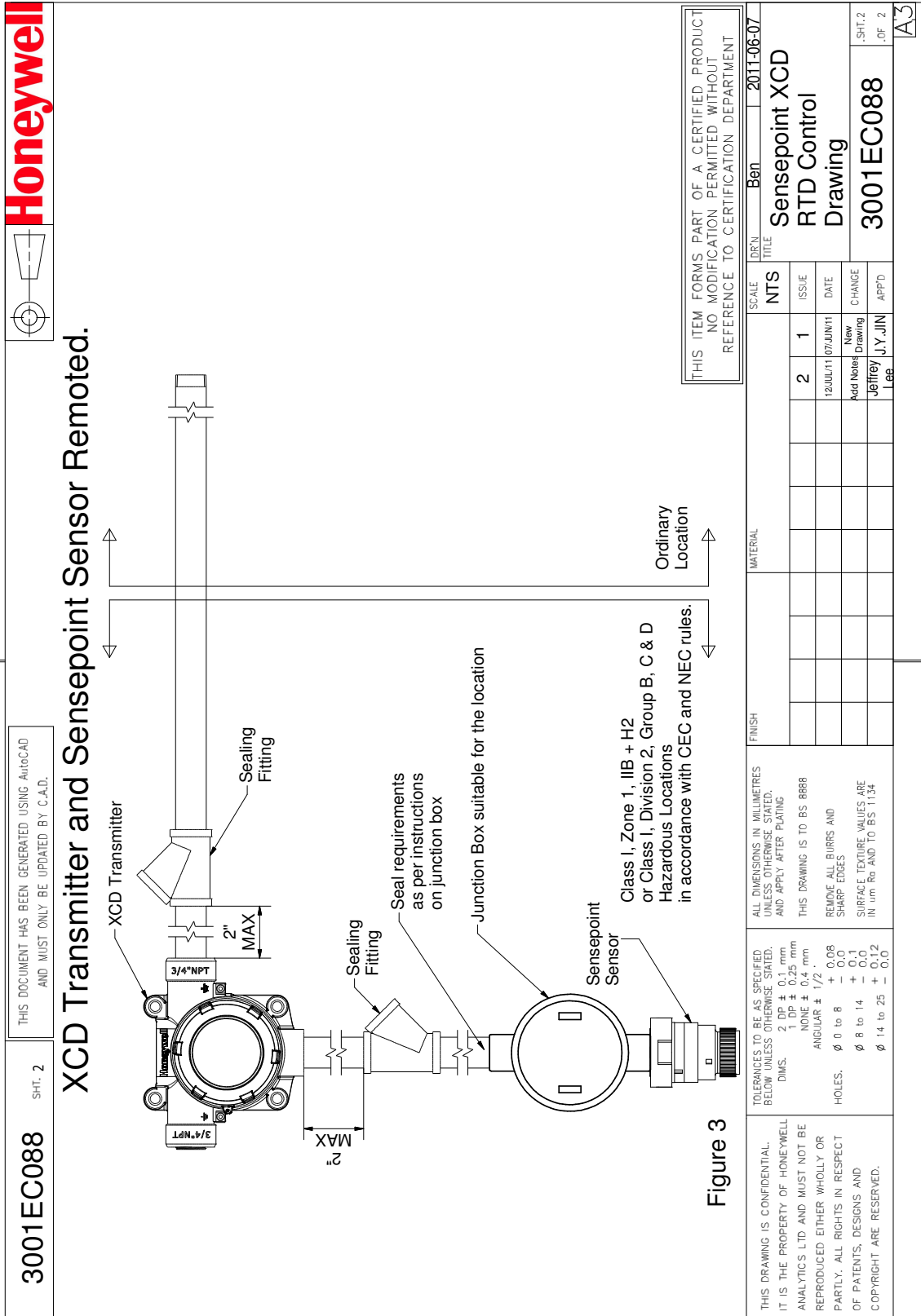

18 Certification

18.1 China GB Ex and PA

China GB Ex (Chinese Version):

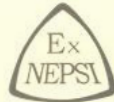

防 爆 合 格 证

证 号: GYJ13.1231X

由 Honeywell Analytics Ltd.	制造的产品:
(地址: Chonan Factory 58, Chaam-dong, Cheonan-City, Choongcheongnam-do, 330200, Korea Republic of)	
名 称 变送器	
型号规格 XCD	
防爆标志 Ex d IIC T5/T6 Gb	
产品标准 /	
图样编号 3001EA026	

经图样及技术文件的审查和样品检验, 确认上述产品符合 **GB 3836.1-2010、GB 3836.2-2010** 标准, 特颁发此证。

本证书有效期: 2013年7月26日至2018年7月25日

备注 1. 安全使用注意事项见本证书附件。
2. 证书编号后缀“X”表明产品具有安全使用特殊条件, 内容见本证书附件。

站 长 

国家级仪器仪表防爆安全监督检验站

颁发日期二〇一三年七月二十六日

本证书仅对与认可文件和样品一致的产品有效。

地址: 上海市漕宝路103号	网址: www.nepsi.org.cn	电话: +86 21 64368180
邮编: 200233	Email: info@nepsi.org.cn	传真: +86 21 64844580

版本05

China GB Ex (English Version):

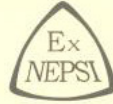

EXPLOSION PROTECTION CERTIFICATE OF CONFORMITY

Cert NO.GYJ13.1231X

This is to certify that the product

Transmitter

manufactured by **Honeywell Analytics Ltd.**
(Address:Chonan Factory 56, Chaam-dong, Cheonan-City, Choongcheongnam-do, 330200, Korea, Republic of)

which model is **XCD**

Ex marking **Ex d II C T5/T6 Gb**

product standard /

drawing number **3001EA026**

has been inspected and certified by NEPSI, and that it conforms
to **GB 3836.1-2010,GB 3836.2-2010**

This Approval shall remain in force until **2018.07.25**

Remarks 1.Conditions for safe use are specified in the attachment to this certificate.
2.Symbol "X" placed after the certification number denotes specific conditions of use,
which are specified in the attachment to this certificate.



Director

National Supervision and Inspection Centre for
Explosion Protection and Safety of Instrumentation

Issued Date **2013.07.26**

This Certificate is valid for products compatible with the documents and samples approved by NEPSI.

103 Cao Bao Road Shanghai 200233, China	http://www.nepsi.org.cn Email: info@nepsi.org.cn	Tel: +86 21 64368180 Fax: +86 21 64844580
--	--	--

Edition 05

China PA Certification:



中华人民共和国

计量器具型式批准证书

PATTERN APPROVAL CERTIFICATE OF THE MEASURING INSTRUMENTS OF THE PEOPLE'S REPUBLIC OF CHINA

韩国 Honeywell Analytics AP

根据《中华人民共和国计量法》及相关规定和技术要求，下列计量器具经定型鉴定合格，现予批准。

According to the Law on Metrology of the People's Republic of China and the relevant regulations, the pattern of measuring instruments applied for pattern approval have been approved.

计量器具名称及型号:

Name and type of the measuring instruments:

气体检测仪 (Sensepoint XCD 型)

规格:CO (0~500) μL/L CH4 (0~100) %LEL

注:本次评价试验仅包含 CO, CH4 两种气体

计量器具的技术指标见型式注册表。

The technical specifications of the measuring instruments are described in the pattern registration list.

型式批准的标志与编号:

The mark and identification numbers of the pattern approval:



2008-C285

批准人 Approval signature



Handwritten signature: 潘长城

批准部门 Approval authority
批准日期 二〇〇八年十月八日 Approval date

- 批准时的附件:
1. 计量器具型式评价报告
2. 型式注册表
3. 型式评价大纲



18.2 Korea KTL

제2013-019938-02호

안 전 인 증 서

한국하니웰(주) 천안공장
충청남도 천안시 서북구2공단2로 28 (성성동)

위 사업장에서 제조하는 아래의 품목이 「산업안전보건법」 제34조 및 같은 법 시행규칙 제58조의4제4항에 따른 안전인증 심사 결과 안전·보건기준에 적합하므로 안전인증표시의 사용을 인증합니다.

	품 목	
	설치용 가스탐지기	
	형식·모델(용량·등급) / 인증번호	
	Sensepoint XCD Transmitter (Ex d IIC T6/T4) / 13-KB2BO-0407	
	인 증 기 준	
	고용노동부고시 제2010-36호	
	인 증 조 건	
	<ol style="list-style-type: none"> 1. 제조공장 본 인증서는 '충청남도 천안시 서북구2공단2로 28 (성성동)'에서 생산하는 제품에 한함 2. 제품개요 ·제품정격: 최대 32 V, 3.5 W ·사용주위온도 : -40 ℃ ≤ Ta ≤ +65 ℃ (for T6) / +75 ℃ (for T4) 3. 인증범위 : 본 인증서는 위의 형식에 한하여 유효함 4. 안전한 사용을 위한 조건 : 없음 5. 인증(변경)사항 : 없음 6. 그 밖의 사항 : 없음 	

2013 년 7 월 18 일

한국산업기술시험원



FP251-8 152-718 서울특별시 구로구 구로동 222-13 <http://www.ktl.re.kr>

18.3 European ATEX

ATEX For Transmitter:

Certificate Number
Baseefa08ATEX0222/1



Issued 3 December 2009
Page 1 of 2

1 SUPPLEMENTARY EC - TYPE EXAMINATION CERTIFICATE

2 Equipment or Protective System Intended for use in Potentially Explosive Atmospheres
Directive 94/9/EC

- 3 Supplementary EC - Type Examination Certificate Number: **Baseefa08ATEX0222/1**
- 4 Equipment or Protective System: **A Type XCD Transmitter**
- 5 Manufacturer: **Honeywell Analytics**
- 6 Address: **405 Barclay Boulevard, Lincolnshire, Illinois, 60069 USA**
- 7 This supplementary certificate extends EC – Type Examination Certificate No. **Baseefa08ATEX0222** to apply to equipment or protective systems designed and constructed in accordance with the specification set out in the Schedule of the said certificate but having any variations specified in the Schedule attached to this certificate and the documents therein referred to.

This supplementary certificate shall be held with the original certificate.

This certificate may only be reproduced in its entirety, without any change, schedule included.

Baseefa Customer Reference No. **5989**

Project File No. **09/0936**

This certificate is granted subject to the general terms and conditions of Baseefa. It does not necessarily indicate that the equipment may be used in particular industries or circumstances.

Baseefa

Rockhead Business Park, Staden Lane,
Buxton, Derbyshire SK17 9RZ
Telephone +44 (0) 1298 766600 Fax +44 (0) 1298 766601
e-mail info@baseefa.com web site www.baseefa.com
Baseefa is a trading name of Baseefa Ltd
Registered in England No. 4305578. Registered address as above.

R S SINCLAIR
DIRECTOR
On behalf of
Baseefa

ATEX Original Certificate For Transmitter:

Certificate Number
Baseefa08ATEX0222



Issued 31 October 2008
Page 1 of 2

- 1 EC - TYPE EXAMINATION CERTIFICATE**
- 2 Equipment or Protective System Intended for use in Potentially Explosive Atmospheres
Directive 94/9/EC**
- 3 EC - Type Examination Certificate Number: Baseefa08ATEX0222**
- 4 Equipment or Protective System: A Type XCD Transmitter**
- 5 Manufacturer: Honeywell Analytics**
- 6 Address: 405 Barclay Boulevard, Lincolnshire, IL 60069, USA.**
- 7 This equipment or protective system and any acceptable variation thereto is specified in the schedule to this certificate and the documents therein referred to.**
- 8 Baseefa, Notified Body number 1180, in accordance with Article 9 of the Council Directive 94/9/EC of 23 March 1994, certifies that this equipment or protective system has been found to comply with the Essential Health and Safety Requirements relating to the design and construction of equipment and protective systems intended for use in potentially explosive atmospheres given in Annex II to the Directive.**
- The examination and test results are recorded in confidential Report No. **GB/BAS/ExTR08.0149/00**
- 9 Compliance with the Essential Health and Safety Requirements has been assured by compliance with:**
IEC60079-0: 2007 EN60079-1: 2007 EN 61241-1: 2006
 except in respect of those requirements listed at item 18 of the Schedule.
- 10 If the sign "X" is placed after the certificate number, it indicates that the equipment or protective system is subject to special conditions for safe use specified in the schedule to this certificate.**
- 11 This EC - TYPE EXAMINATION CERTIFICATE relates only to the design and construction of the specified equipment or protective system. Further requirements of the Directive apply to the manufacturing process and supply of this equipment or protective system. These are not covered by this certificate.**
- 12 The marking of the equipment or protective system shall include the following :**
⊕ II GD Ex d IIC Gb T6 (Ta -40°C to +65°C) Ex tb IIIC T85°C Db IP66
- This certificate may only be reproduced in its entirety, without any change, schedule included.

Baseefa Customer Reference No. 5989

Project File No. 08/0201

This certificate is granted subject to the general terms and conditions of Baseefa. It does not necessarily indicate that the equipment may be used in particular industries or circumstances.

Baseefa
Rockhead Business Park, Staden Lane,
Buxton, Derbyshire SK17 9RZ
Telephone +44 (0) 1298 766600 Fax +44 (0) 1298 766601
e-mail info@baseefa.com web site www.baseefa.com
Baseefa is a trading name of Baseefa Ltd
Registered in England No. 4305578. Registered address as above.

DS Sinclair
PP DISREARLES
R S SINCLAIR
DIRECTOR
On behalf of
Baseefa

ATEX for Sensor

Certificate Number
Baseefa08ATEX0263X



Issued 19 January 2009
Page 1 of 3

- 1 **EC - TYPE EXAMINATION CERTIFICATE**
- 2 **Equipment or Protective System Intended for use in Potentially Explosive Atmospheres**
Directive 94/9/EC
- 3 EC - Type Examination Certificate Number: **Baseefa08ATEX0263X**
- 4 Equipment or Protective System: **Sensepoint Toxic Gas Detector Head**
- 5 Manufacturer: **Honeywell Analytics limited**
- 6 Address: **4 Stinsford Road, Nuffield Estate, Poole, Dorset, BH17 0RZ**
- 7 This equipment or protective system and any acceptable variation thereto is specified in the schedule to this certificate and the documents therein referred to.
- 8 Baseefa, Notified Body number 1180, in accordance with Article 9 of the Council Directive 94/9/EC of 23 March 1994, certifies that this equipment or protective system has been found to comply with the Essential Health and Safety Requirements relating to the design and construction of equipment and protective systems intended for use in potentially explosive atmospheres given in Annex II to the Directive.
- The examination and test results are recorded in confidential Report No. **GB/BAS/ExTR08.0141/00 & GB/BAS/ExTR08.0142/00**
- 9 Compliance with the Essential Health and Safety Requirements has been assured by compliance with:
IEC 60079-0: 2007 EN 60079-0: 2006 EN 60079-1: 2007 EN 60079-11: 2007 EN 61241-1: 2004
except in respect of those requirements listed at item 18 of the Schedule.
- 10 If the sign "X" is placed after the certificate number, it indicates that the equipment or protective system is subject to special conditions for safe use specified in the schedule to this certificate.
- 11 This EC - TYPE EXAMINATION CERTIFICATE relates only to the design and construction of the specified equipment or protective system. Further requirements of the Directive apply to the manufacturing process and supply of this equipment or protective system. These are not covered by this certificate.
- 12 The marking of the equipment or protective system shall include the following :
- ⊕ II 2GD Ex d ia IIC T4 Gb Ex tb IIIC A21 IP67 T135°C Db (T_{amb} -40°C to + 65°C)**
- This certificate may only be reproduced in its entirety, without any change, schedule included.

Baseefa Customer Reference No. **0981**

Project File No. **08/0218**

This certificate is granted subject to the general terms and conditions of Baseefa. It does not necessarily indicate that the equipment may be used in particular industries or circumstances.





Baseefa

Rockhead Business Park, Staden Lane,
Buxton, Derbyshire SK17 9RZ
Telephone +44 (0) 1298 766600 Fax +44 (0) 1298 766601
e-mail info@baseefa.com web site www.baseefa.com
Baseefa is a trading name of Baseefa Ltd
Registered in England No. 4305578. Registered address as above.



R S Sinclair
PP DIRECTOR
R S SINCLAIR
DIRECTOR
On behalf of
Baseefa

18.4 International IEC

IEC Ex for Transmitter

		<h1 style="text-align: center;">IECEX Certificate of Conformity</h1>	
INTERNATIONAL ELECTROTECHNICAL COMMISSION IEC Certification Scheme for Explosive Atmospheres <small>for rules and details of the IECEx Scheme visit www.iecex.com</small>			
Certificate No.:	IECEX BAS 08.0072	issue No.:	1
Status:	Current	Certificate history: Issue No. 1 (2009-12-8) Issue No. 0 (2008-11-10)	
Date of Issue:	2009-12-08	Page 1 of 4	
Applicant:	Honeywell Analytics 405 Barclay Boulevard Lincolnshire Illinois 60069 United States of America		
Electrical Apparatus:	A Type XCD Transmitter		
Optional accessory:			
Type of Protection:	Flameproof		
Marking:	Ex d IIC Gb T6 (Ta -40°C to +65°C) Ex tb IIIC T85°C Db IP66		
Approved for issue on behalf of the IECEx Certification Body:	R S Sinclair		
Position:	Managing Director		
Signature: (for printed version)			
Date:			
1. This certificate and schedule may only be reproduced in full. 2. This certificate is not transferable and remains the property of the issuing body. 3. The Status and authenticity of this certificate may be verified by visiting the Official IECEx Website .			
Certificate issued by: <div style="display: flex; justify-content: space-between; align-items: center;"> <div style="text-align: center;"> Baseefa Rockhead Business Park Staden Lane Buxton Derbyshire SK17 9RZ United Kingdom </div> <div style="text-align: center;">  </div> </div>			

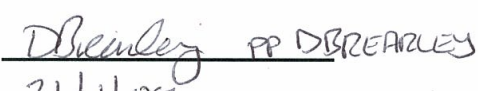
IEC Ex for Sensor

		<h1>IECEX Certificate of Conformity</h1>	
INTERNATIONAL ELECTROTECHNICAL COMMISSION IEC Certification Scheme for Explosive Atmospheres <small>for rules and details of the IECEx Scheme visit www.iecex.com</small>			
Certificate No.:	IECEX BAS 08.0070X	issue No.:0	Certificate history: <input type="text"/>
Status:	Current		
Date of Issue:	2009-01-20	Page 1 of 3	
Applicant:	Honeywell Analytics Limited Hatchpond House 4 Stinsford Road Nuffield Estate Poole Dorset BH17 ORZ United Kingdom		
Electrical Apparatus:	Sensepoint Toxic Gas Detector Head		
Optional accessory:			
Type of Protection:	Flameproof, intrinsic safety and Dust		
Marking:	Ex d ia IIC Gb T4 (Tamb -40oC to + 65oC) Ex tb IIIC A21 IP67 T135oC Db (Tamb -40oC to + 65oC)		
Approved for issue on behalf of the IECEx Certification Body:	R S Sinclair		
Position:	Managing Director		
Signature: (for printed version)			
Date:			
1. This certificate and schedule may only be reproduced in full. 2. This certificate is not transferable and remains the property of the issuing body. 3. The Status and authenticity of this certificate may be verified by visiting the Official IECEx Website .			
Certificate issued by:	Baseefa Rockhead Business Park Staden Lane Buxton Derbyshire SK17 9RZ United Kingdom		
			

18.5 North America cCSAus



Certificate of Compliance

Certificate: 2404330

Master Contract: 246287

Project: 2404330

Date Issued: July 22, 2011

Issued to: Honeywell Analytics Inc.

405 Barclay Blvd
Lincolnshire, IL 60069
USA
Attention: John Stratman

The products listed below are eligible to bear the CSA Mark shown with adjacent indicators 'C' and 'US' for Canada and US or with adjacent indicator 'US' for US only or without either indicator for Canada only.



Glenn Black

Issued by: Glenn Black

PRODUCTS

CLASS 4828 82 - SIGNAL APPLIANCES-Toxic Gas Detection Instruments - For Hazardous Locations. Certified to U.S. Standards

CLASS 4828 02 - SIGNAL APPLIANCES - Toxic Gas Detection Instruments - For Hazardous Locations

CLASS 4828 02

Ex d IIB+H2;

Class I, Div. 2, Groups B, C and D;

Sensepoint XCD/RTD Stationary Toxic gasses & Oxygen Gas Transmitter, Input rated 16 to 32 VDC, 3 watts max. Temperature code T4, Relay ratings 3X5A@250VAC, with or without RS-485 Module, Tamb -40 Deg. C to +65 Deg. C. For use with integral Sensepoint Toxic/oxygen sensor head p/n 2106B18xx or with remote junction box fitted with Sensepoint Toxic/oxygen sensor head p/n 2106B18xx when installed per control drawing 3001EC088.

Note: XX may be 00 to 02, 05 to 07, 10 to 18, 20 to 22 and 30 depending on which gas cell is installed in the Sensepoint Toxic sensor head.



Certificate: 2404330

Master Contract: 246287

Project: 2404330

Date Issued: July 22, 2011

Ex d ia IIC;

Class I, Div. 2, Groups B, C and D;

Sensepoint Toxic sensor head p/n 2106B18xx(Toxic gasses & Oxygen), Input rated 32 VDC, 0.9 watts max. Temperature code T4 when installed per control drawing 3001EC088.

Note: XX may be 00 to 02, 05 to 07, 10 to 18, 20 to 22 and 30 depending on which gas cell is installed in the Sensepoint Toxic sensor head.

CLASS 4828 82

Class I, Zone 1, AEx d IIB+H2;

Sensepoint XCD/RTD Stationary Toxic gasses & Oxygen Gas Transmitter, Input rated 16 to 32 VDC, 3 watts max. Temperature code T4, Relay ratings 3X5A@250VAC, with or without RS-485 Module, Tamb -40 Deg. C to +65 Deg. C. For use with integral Sensepoint Toxic/oxygen sensor head p/n 2106B18xx or with remote junction box fitted with Sensepoint Toxic/oxygen sensor head p/n 2106B18xx when installed per control drawing 3001EC088.

Note: XX may be 00 to 02, 05 to 07, 10 to 18, 20 to 22 and 30 depending on which gas cell is installed in the Sensepoint Toxic sensor head.

Class I, Zone 1, AEx d ia IIC Gb;

Class I, Div. 2, Groups B, C and D;

Sensepoint Toxic sensor head p/n 2106B18xx(Toxic gasses & Oxygen), Input rated 32 VDC, 0.9 watts max. Temperature code T4 when installed per control drawing 3001EC088.

Note: XX may be 00 to 02, 05 to 07, 10 to 18, 20 to 22 and 30 depending on which gas cell is installed in the Sensepoint Toxic sensor head.

APPLICABLE REQUIREMENTS

CAN/CSA-C22.2 No. 0-M91 - General Requirements – Canadian Electrical Code, Part II



Certificate: 2404330

Master Contract: 246287

Project: 2404330

Date Issued: July 22, 2011

CAN/CSA-C22.2 No. 60079-0:07 - Electrical apparatus for explosive gas atmospheres - Part 0: General Requirements

ANSI/UL 60079-0:09 - Electrical Apparatus for Explosive Gas Atmospheres - Part 0: General Requirements

CAN/CSA-E60079-11:02 - Electrical apparatus for explosive gas atmospheres - Part 11: Intrinsic Safety "i"
CAN/CSA-E60079-11:02

ANSI/UL 60079-11:09 - Electrical apparatus for Explosive Gas Atmospheres - Part 11: Intrinsic Safety "i"

CAN/CSA-C22.2 No. 60079-1:07 - Electrical apparatus for explosive gas atmospheres - Part 1: Flameproof enclosures "d".

ANSI/UL 60079-1:09 - Electrical Apparatus for Explosive Gas Atmospheres - Part 1: Flameproof Enclosures "d"

C22.2 No. 142-M1987 - Process Control Equipment

C22.2 No. 213-M1987 - Non-Incendive Electrical Equipment for Use in Class I, Division 2 Hazardous Locations

UL 508 17th Ed.- Industrial Control Equipment

ANSI/ISA -12.12.01-2010 - Non-Incendive Electrical Equipment for Use in Class I and II, Division 2 and Class III, Divisions 1 and 2 Hazardous(Classified) Locations.

18.6 ATEX Name Plate

3001EA041 SHT. 1

THIS DOCUMENT HAS BEEN GENERATED USING ADOBE ILLUSTRATOR AND MUST ONLY BE UPDATED BY A.I.

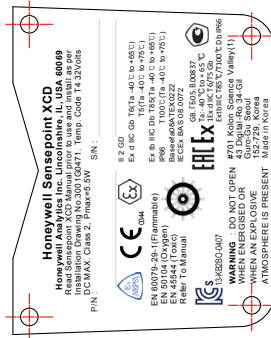

NOTES

- This is an ATEX schedule drawing and can only be changed after approval is given by the certifying body
- Product name format:
 Honeywell Sensepoint XCD XXX
 XXX — Blank - Sensepoint XCD for use with Sensepoint XCD socket and sensor.
 RTD - Sensepoint XCD RTD for use with mA input sensors such as Sensepoint Toxic.
 RFD - Sensepoint XCD RFD for use with mV input sensors such as Sensepoint Flammable
- Serial no. format
 S/N: SJPPPPYYWWNNNN
 SJ — Part Code
 PP — Year of MFG
 YY — Week of MFG
 WW — Sequence number
 NN — Issue State
 SUPPLIER CODE
- Etching Depth : 0.1 mm

THIS ITEM FORMS PART OF A CERTIFIED PRODUCT
 NO MODIFICATION PERMITTED WITHOUT
 REFERENCE TO CERTIFICATION DEPARTMENT

FINISH		MATERIAL										SCALE		DRAWING TITLE											
11	29AUG15	10SEP13	05SEP13	06OCT12	03SEP12	03MAY12	24APR12	12DEC11	01JUL10	18NOV09	2	3	4	5	6	7	8	9	10	11	NONE	Sensepoint XCD ATEX Name Plate		16 /MAY/08	
ADD Cert. EAC		Change Cert. Mark	Change Form to 5.5	Add Rebr. to Manual	Add Rebr. of Origin	Adjusted Description	CHANGED Description	ADD Cert. No.	ADD Cert. MED	ADD. NOTES	ISSUE	DATE	CHANGE	APPROVED BY											
Jeffrey L. Jeffrey		Jeffrey L. Jeffrey	Jeffrey L. Jeffrey	Jeffrey L. Jeffrey	Jeffrey L. Jeffrey	Jeffrey L. Jeffrey	Jeffrey L. Jeffrey	Jeffrey L. Jeffrey	Jeffrey L. Jeffrey	J. Y. JIN	J. Y. JIN	J. Y. JIN	J. Y. JIN	J. Y. JIN											
												3001EA041		SHT. 1 OF 1											

THIS DRAWING IS CONFIDENTIAL. IT IS THE PROPERTY OF HONEYWELL ANALYTICS LTD AND MUST NOT BE REPRODUCED EITHER WHOLLY OR PARTLY. ALL RIGHTS IN RESPECT OF PATENTS, DESIGNS AND COPYRIGHT ARE RESERVED.

18.7 cCSAus Transmitter Name Plate

3001EC086 SHT. 1

THIS DOCUMENT HAS BEEN GENERATED USING
 ADOBE ILLUSTRATOR AND MUST ONLY BE UPDATED BY A.I.

Honeywell Sensepoint XCD/RTD

Honeywell Analytics Inc. Lincolnshire, IL, USA 60069

For use with Integral or Remote Sensepoint Toxic or Oxygen Sensors when installed per drawing No. 3000EC088, Fig. 1 & 3.

EX.d IIB+H2; Class I, Zone 1, AEx d IIB+H2; Class I, Division 2, Groups B, C & D. Read Sensepoint XCD/ C US RTD manual prior to use.

Temp. Code T4, 16~32Volts DC, Pmax=5W, Tamb.-40°C to +65°C. CSA11 2404330.

P/N : _____

S/N : _____

WARNING : To reduce the risk of Hazardous Atmospheres, Disconnect the equipment from supply circuit before opening. Keep tightly closed when in operation. Conduit runs must have a seal fitting within 2 inches of the enclosure.

Honeywell Sensepoint XCD/RTD

Honeywell Analytics Inc. Lincolnshire, IL, USA 60069

For use with Integral or Remote Sensepoint Toxic or Oxygen Sensors when installed per drawing No. 3000EC088, Fig. 1 & 3.

EX.d IIB+H2; Class I, Zone 1, AEx d IIB+H2; Class I, Division 2, Groups B, C & D. Read Sensepoint XCD/ C US RTD manual prior to use.

Temp. Code T4, 16~32Volts DC, Pmax=5W, Tamb.-40°C to +65°C. CSA11 2404330.

P/N : _____

S/N : _____

WARNING : To reduce the risk of Hazardous Atmospheres, Disconnect the equipment from supply circuit before opening. Keep tightly closed when in operation. Conduit runs must have a seal fitting within 2 inches of the enclosure.

SCALE 2/1

THIS ITEM FORMS PART OF A CERTIFIED PRODUCT
 NO MODIFICATION PERMITTED WITHOUT
 REFERENCE TO CERTIFICATION DEPARTMENT

SCALE		DR'N BEN	
NONE		17 / JUN / 11	
FINISH		TITLE	
		Sensepoint XCD/RTD	
		CSA Name Plate	
		3001EC086	
		SHT. 1 OF 1	
MATERIAL		CHANGE	
		NEW DRAWING	
		ACTIONED BY	
		J.Y.JIN	
TOLERANCES TO BE AS SPECIFIED BELOW UNLESS OTHERWISE STATED.		ISSUE	
DIMS. 2 DP ± 0.1 mm		1	
1 DP ± 0.25 mm		DATE	
NONE ± 0.4 mm		17/JUN/11	
ANGULAR ± 1/2°			
Holes: φ 0 to 8 + 0.08 - 0.0			
φ 8 to 14 + 0.1 - 0.0			
φ 14 to 25 + 0.12 - 0.0			
ALL DIMENSIONS IN MILLIMETRES UNLESS OTHERWISE STATED. AND APPLY AFTER PLATING.			
THIS DRAWING IS TO BS 8888			
REMOVE ALL BURRS AND SHARP EDGES			
SURFACE TEXTURE VALUES ARE IN µm Ra AND TO BS 1134			

18.8 cCSAus Sensor Name Plate

2106E0031

SHT. 1

THIS DOCUMENT HAS BEEN GENERATED USING AutoCAD
AND MUST ONLY BE UPDATED BY C.A.D.

Honeywell Analytics Ltd Sensepoint Toxic
Pooler BH17 0RZ UK REFER TO MANUAL BEFORE OPENING
 WARNING - STATIC RISK - READ MANUAL Vmax=32V DC Pmax=0.9W CLASS I ZONE 1 AEx d ia IIC Gb

Cert Label: Rear Body

3/4 NPT

Thread size marked on hex flat

Cert Label: Front Body

XXXXXX/XX

Serial Number.
Last two characters indicate year of manufacture

NOTES:
FOR FIXING DETAILS REFER TO RELEVANT CERTIFICATION GENERAL ASSEMBLY DRAWINGS

THIS ITEM FORMS PART OF A CERTIFIED PRODUCT.
NO MODIFICATION PERMITTED WITHOUT REFERENCE TO CERTIFYING AUTHORITY

18.9 EU Declaration of Conformity



Honeywell

EU Declaration of Conformity

In accordance with EN ISO / IEC 17050-1:2010

SENSEPOINT XCD TRANSMITTER

Declaration Number: 2004Y0027 (Rev.07)

Description: Flammable, toxic and oxygen gas detector
Intended Use: Monitoring of gas hazards in potentially explosive atmospheres, both indoors and outdoors

Manufacturer: Honeywell Analytics Asia Pacific Co. Ltd
 7F SangAm IT Tower 434 Worldcup Buk-ro, Mapo-gu, Seoul 03922, South Korea

Trading Company: Life Safety Distribution GmbH
 Javastrasse 2, 8604 Hegnau, Switzerland

We hereby declare that the product identified above meets the requirements of the following EU Directives and therefore qualifies for free movement within markets comprising the European Union (EU) and the European Economic Area (EEA). This declaration is issued under the sole responsibility of the manufacturer.

ATEX Directive 2014/34/EU

ATEX Hazardous

Notified Body: SGS Baseefa Limited
 Rockhead Business Park, Staden Lane, Buxton, Derbyshire, SK17 9RZ.
 1180
Notified Body Number:
EC Certificate Number: Baseefa08ATEX0222

Conforms to:

IEC 60079-0:2011	Explosive atmospheres. Equipment - General requirements
EN 60079-1:2007	Explosive atmospheres. Equipment protection by flameproof enclosures "d"
EN 60079-31:2014*	Explosive atmospheres. Equipment dust ignition protection by enclosure "t"

Type Approval:  II 2 GD Ex d IIC T6 (Ta -40°C to +65°C) Gb
 T5 (Ta -40°C to +75°C)
 Ex tb IIIC T85°C (Ta -40°C to +65°C) Db IP66
 T100°C (Ta -40°C to +75°C)

* There are no significant changes relevant to the product between EN 60079-31:2009 and EN 60079-31:2014, therefore Baseefa certification remains current

A04797

2004Y0027-7

**Production Quality Assurance**

Notified Body: DEKRA Certification B.V.
Meander 1051, 6825 MJ Arnhem, P.O. Box 5185, Arnhem.The Netherlands
Notified Body Number: 0344
QA Notification Number: DEKRA 12ATEXQ0218

Conforms to:
EN ISO/IEC 80079-34:2011 Explosive atmospheres. Application of quality systems for equipment manufacture

Marine Equipment Directive 96/98/EC as amended,

Notified Body: DNV-GL
Veritasveien 1, 1363 Høvik, Norway.
Notified Body Number: 0575
Module B Certificate Numbers: MED-B-9755 – Sensepoint XCD O₂ and Flammable
(amended by directive 2013/52/EU)
MED-B-7712 – Sensepoint XCD Flammable-IR
(amended by directive 2010/68/EU)
Module D Certificate Number: MED-D-2044
(amended by directive 2013/52/EU)



0575/xx

Conforms to:

IEC 60092-504:2001	Electrical Installation in ships. Special features. Control and instrumentation
IEC 60533:1999	Electrical and electronic installations in ships. Electromagnetic compatibility
EN 60945:2002	Maritime navigation and radio communication equipment and systems. General requirements. Methods of testing and required test results
EN 50104:2010	Electrical apparatus for the detection and measurement of oxygen. Performance requirements and test methods
EN 60079-29-1:2007	Explosive atmospheres. Gas Detectors. Performance requirements of detectors for flammable gases

EMC Directive 2014/30/EU

Conforms to:
EN 50270:2006 Electromagnetic compatibility. Electrical apparatus for the detection and measurement of combustible gases, toxic gases and oxygen

Signature:

Name: Biro Cho
HIS Quality Leader

Date: 20th April 2016

For and on behalf of: **Honeywell Analytics Asia Pacific Co. Ltd.**
7F SangAm IT Tower 434 Worldcupbuk-ro, Mapo-gu, Seoul 03922, South Korea

A04797

2004Y0027-7

19 Cross Interference

Please refer Sensepoint Technical Handbook (PN: 2106M0502) for detail

XCD Transmitter

Appendix A - Modbus® Protocol A-2

A.1 Modbus and the XCD

The XCD gas detector may be fitted with the optional Modbus board. Authoritative information on the MODBUS Upgrade Kit can be found at www.modbus.org. The XCD supports Modbus/RTU over an RS-485 physical layer. The interface is isolated and baud rates 9600 or 19,200 are supported with 19,200 as the default. Most of the operations that are possible with local user interfaces can also be performed using the Modbus interface. This includes configuration operations. However, this Appendix only describes how to monitor XCD status using Modbus.

See Section 4.4.1 for information on installing the optional Modbus hardware. See Section 4.4.1 Configure Menu – Set ID Settings for information on setting the Modbus baud rate and Parity using the local user interface.

A.2 Modbus Registers

ModBus Register Address	Information	R/W	Type	Size	Note
30001	Main SW Version of XCD	R	u8	1	
30002	EEP Version of XCD	R	u8	1	
30003	WatchDog s/w Version of XCD	R	u8	1	
30004	Location string	R	string[12]	6	
30010	ModBus slave ID	R	u8	1	
30011	Monitor Status	R	u16	1	Upper byte : Function Lower byte : Instrument Mode
30012	Inhibit current (mA)	R	u8	1	20 means 2.0mA
30013	Reserved	R	u16	1	
30014	Active Alarm	R	u32	2	bit 0 Alarm 1 is active bit 1 Alarm 2 is active
30016	Latched Alarm	R	u32	2	bit 0 Alarm 1 is active bit 1 Alarm 2 is active
30018	Active Fault	R	u32	2	Upper byte: Fault Lower byte: Warning bit 0:W-01 ~ bit 5:W-06 bit 6:F-01 ~ bit 18:F-13
30020	Latched Fault	R	u32	2	Upper byte: Fault Lower byte: Warning bit 0:W-01 ~ bit 5:W-06 bit 6:F-01 ~ bit 18:F-13
40001	System ID code	R	u16	1	Upper Byte : Type Code : 0x25 Lower Byte : My Address
40002	System ID code	R	u16	1	Upper Byte : Type Code : 0x25 Lower Byte : My Address : Dummy Spacer
40003	Gas reading	R	f32	2	
40005	Fault and Warning	R	u8	1	Fault = 1100 + Number Warning = Number as is
40006	Alarm, fault and warning state	R	u8	1	bit 0 Alarm 1 is active bit 1 Alarm 2 is active bit 2,3 for future expansion bit 4 Warning is active bit 5 Fault is active bit 6,7 for future expansion Note: Latching relay setting latches Modbus values in register 40006.
40007	Monitor state monitoring	R	u8	1	1 : Normal 2 : Warm Up after power on 3 : Inhibit 12 : Calibration
40008	Reserved	R	u16	1	
40009	Calibration Due	R	f32	2	
40011	Measuring Unit	R	u8	1	4 : PPM 3 : %Vol 5 : %LEL 1 : mg/m3
40012	Peak Reading	R	f32	2	Peak Reading
40014	Reserved	R	u16	3	
40017	Temperature (°C)	R	s16	1	
40018	Reserved	R	u16	28	
40046	Measuring Gas name string	R	string[14]	7	
40053	Reserved	R	s16	1	
40054	Temperature (°F)	R	s16	1	
40055	Reserved	R	u16	1	
40056	Relay Status	R	u8	1	1 : Energized, 0 : De-energized
40057	Power Supply	R	f32	2	
40059	Calibration Interval	R/W	u16	1	
40060	Alarm Type	R/W	u8	1	High nibble : Alarm 2 Type Low nibble : Alarm 1 Type 0: Disable, 1: Rising, 2:Falling
40061	Inhibit timeout	R/W	u16	1	
40062	Relay configuration	R/W	u8	1	Bit:0 ~ 2 : Relay Type 1 ~ Relay Type 3 Bit:3 ~ 5 : Relay Status 1 ~ Relay Status 3 Bit:6 : Relay Latch Status
40063	Relay On Delay Time (s)	R	u16	1	Relay activation delay time (seconds)
40064	Relay Off Delay Time (s)	R	u16	1	Relay deactivation delay time (seconds)
40065	Full scale range	R	f32	2	User configured full scale range
40067	Alarm threshold1	R	f32	2	
40069	Alarm threshold2	R	f32	2	
40071	Span gas concentration	R	f32	2	

Find out more

www.honeywellanalytics.com

Contact Honeywell Analytics:**Americas**

Honeywell Analytics, Inc.
405 Barclay Blvd.
Lincolnshire, IL 60069
USA
Tel: +1 847 955 8200
Toll free: +1 800 538 0363
Fax: +1 847 955 8210
detectgas@Honeywell.com

Europe, Middle East, Africa

Life Safety Distribution GmbH
Javastrasse 2
8604 Hegnau
Switzerland
Tel: +41 (0)44 943 4300
Fax: +41 (0)44 943 4398
gasdetection@honeywell.com

Asia Pacific, India

Honeywell Analytics Asia Pacific, Co., Ltd.
7F SangAm IT Tower
434 Worldcup Buk-ro, Mapo-gu
Seoul 03922
South Korea
Tel: +82 (0)2 6909 0300
Fax: +82 (0)2 2025 0388
India Tel: +91 124 4752700
analytics.ap@honeywell.com

Please Note:

While every effort has been made to ensure accuracy in this publication, no responsibility can be accepted for errors or omissions. Data may change, as well as legislation, and you are strongly advised to obtain copies of the most recently issued regulations, standards, and guidelines. This publication is not intended to form the basis of a contract.

Issue 4 09/2016
3001M5021_4
SPXCDHMRTE
MAN0897_EMEAI
© 2016 Honeywell Analytics

The Honeywell logo is displayed in a bold, red, sans-serif font.