



Dolphin™ CN80

powered by Android™

Quick Start Guide

Out of the Box

Make sure that your shipping box contains these items:

- Dolphin CN80 mobile computer (Model CN80LON or CN80L1N)
- Rechargeable 3.85 VDC Li-ion battery
- Stylus and tether
- Hand strap
- Product documentation

If you ordered accessories for your mobile computer, verify that they are also included with the order. Be sure to keep the original packaging in case you need to return the mobile computer for service.

Note: *CN80LON models do not include a WWAN radio.*

Memory Card Specifications

Honeywell recommends the use of Single Level Cell (SLC) industrial grade microSD™ or microSDHC™ memory cards with Dolphin mobile computers for maximum performance and durability. Contact a Honeywell sales representative for additional information on qualified memory card options.

Mobile Computer Features

CN80 Model with 6603ER Imager

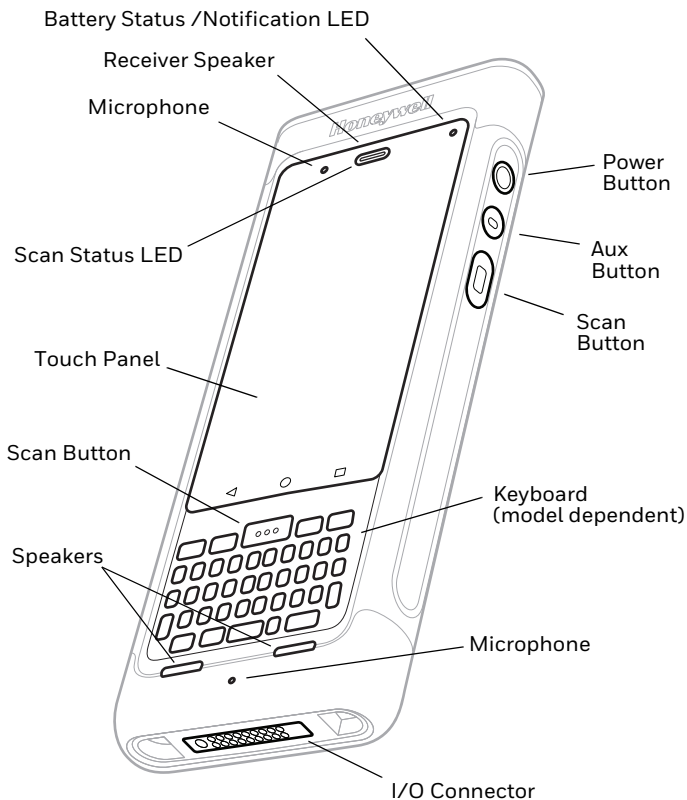

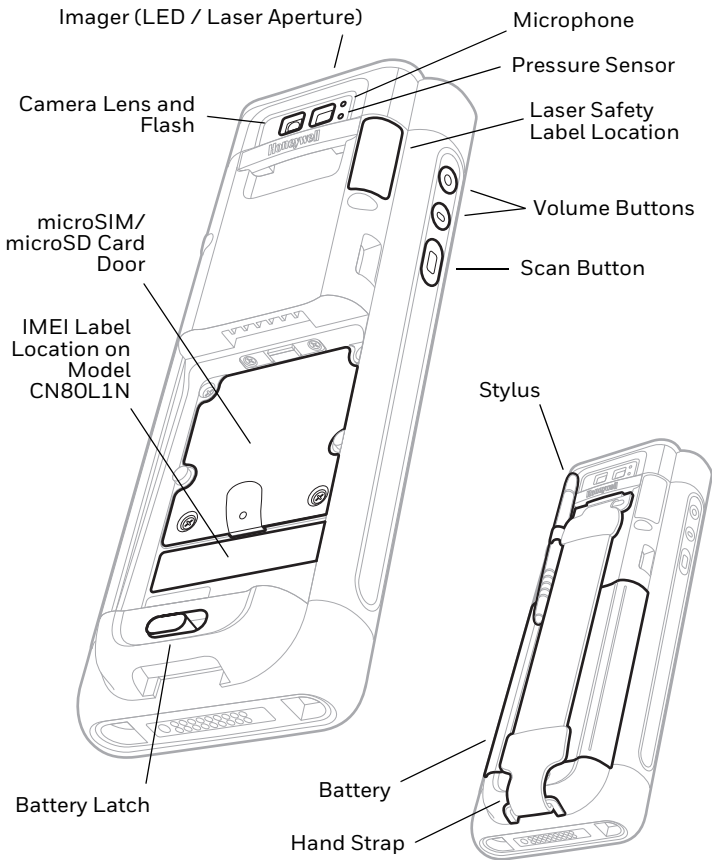

CN80 Model with EX20 Near/Far Imager

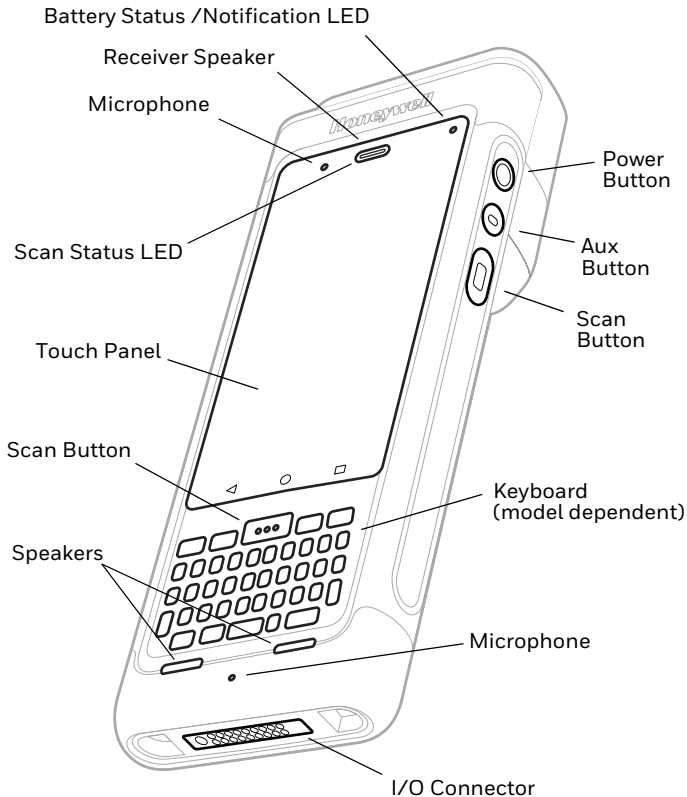

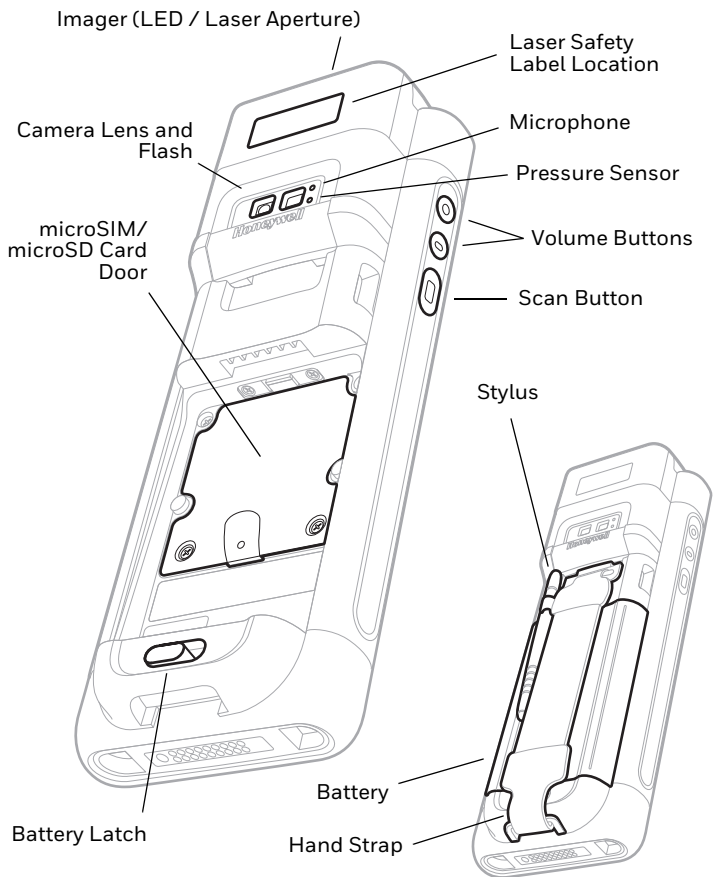

Install a microSIM Card / Install a microSD Card



Always power off the computer before attempting to install or remove a card.

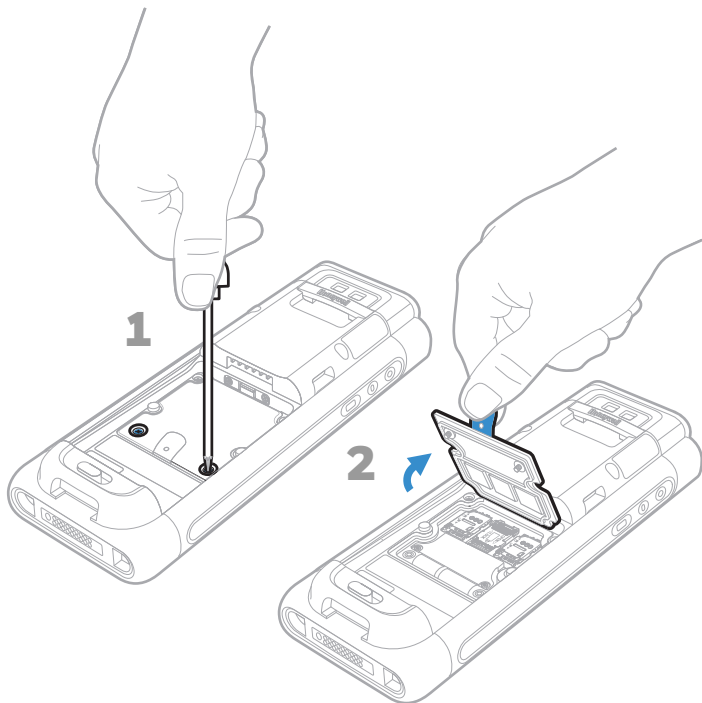

SIM 1

Phone feature is available only on CN80L1N models.

When using a UICC card for NFC Secure Element NFC link encryption, install the card in SIM slot 1.

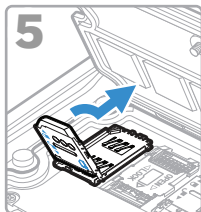
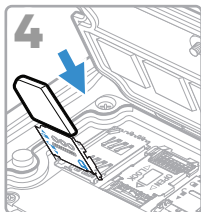
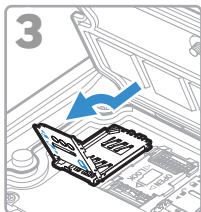

SIM 2

SIM 2 feature is available only on CN80L1N models.

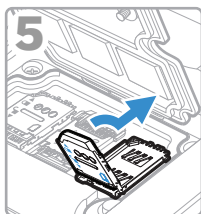
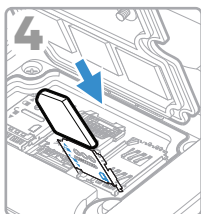
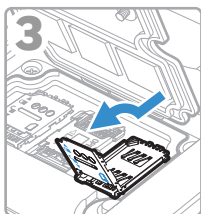

microSD

Format the microSD card before initial use.

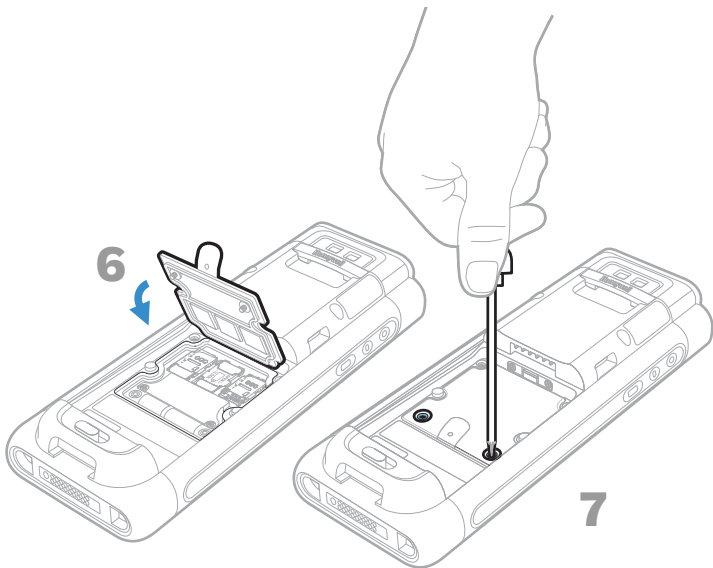
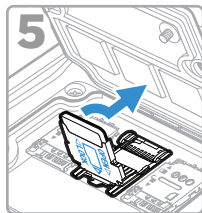
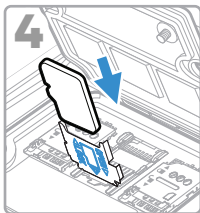
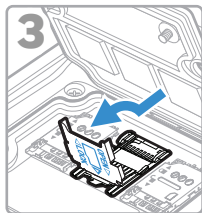

Install the Battery

The CN80 mobile computer ships with a Li-ion 3.85 VDC, 22.3 watt-hour battery manufactured for Honeywell International Inc.



Use only Honeywell Li-ion battery pack model CW-BAT (SKU CX80-BAT-EXT-WRLS1).

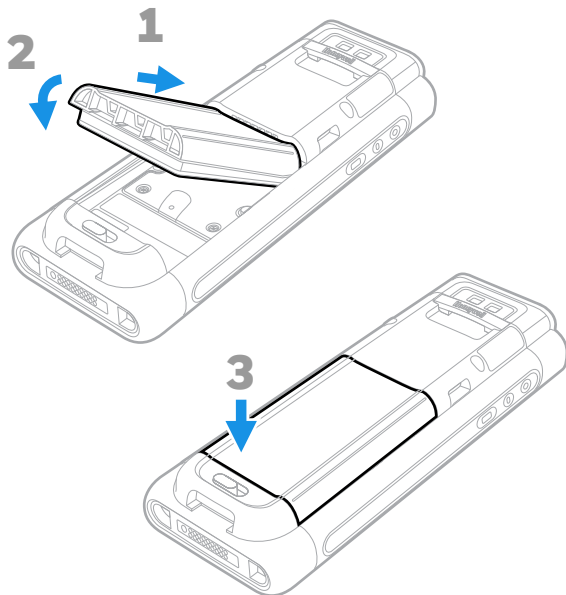

Ensure all components are dry prior to placing the battery in the computer. Mating wet components may cause damage not covered by the warranty.

Install the Hand Strap

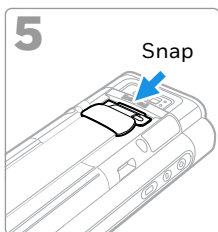
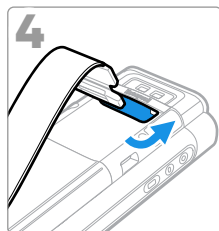
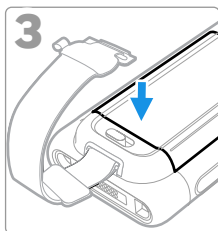
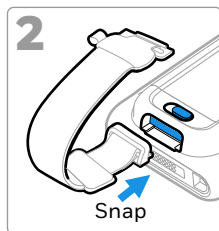
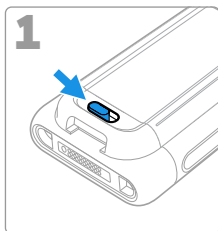

Charge the Mobile Computer

The CN80 mobile computer ships with a partially charged battery. Charge the battery with a CX80 Series charging device for a minimum of **4 hours**. Using the computer while charging the battery increases the time required to reach a full charge.



We recommend the use of Honeywell accessories and power adapters. Use of any non-Honeywell accessories or power adapters may cause damage not covered by the warranty.



Before you attempt to use, charge or replace the battery in the device, carefully read all labels, markings and product documentation provided in the box or online at sps.honeywell.com. To learn more about Battery Maintenance for Portable Devices, go to honeywell.com/PSS-BatteryMaintenance.

CN80 mobile computers are designed for use with the following CX80 Series charging accessories: HomeBase, Ethernet HomeBase, ChargeBase, NetBase, Quad Battery Charger, Vehicle Power Adapter, Vehicle Dock, and Snap-on Adapters.



Ensure all components are dry prior to mating the computers and batteries with peripheral devices. Mating wet components may cause damage not covered by the warranty.

Turn Power On/Off

To turn the computer on:

- Press and hold the **Power** button for approximately 3 seconds, and then release.

To turn the computer off:

1. Press and hold the **Power** button until the options menu appears.
2. Touch **Power Off**.

Battery Swap Mode for Battery Replacement

You should always place the computer in Battery Swap mode before removing the battery. Battery Swap mode places the computer in a low power state so that the battery can be removed for a short time.

To activate Battery Swap mode:

1. Press and hold the **Power** button until the options menu appears.
2. Touch **Swap Battery** and follow the on-screen instructions.
3. Once you replace the battery, press the **Power** button.

Sleep Mode

Sleep mode automatically turns the touch panel display off and locks the computer to save battery power when the computer is inactive for a programmed period of time.

- Press and release the **Power** button to wake the computer.

Adjust the Display Sleep Time

To adjust the amount of time before the display sleeps after inactivity:

1. Swipe up > **Settings** > **Display** > **Screen Timeout**.
2. Select the amount of time before the display goes to sleep.
3. Touch  to return to the Home screen.

About the Home Screen

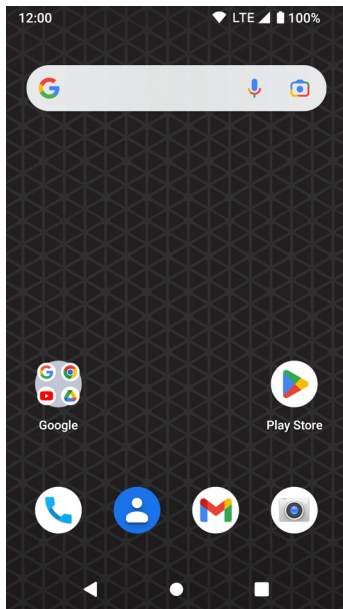

Notification /
Status Bar

Search Bar

Touch  to initiate a
voice search or
command.





Home Screen
Panel

Favorites Tray

Navigation Buttons

To learn how to customize the Home screen, see the user guide.

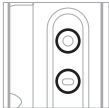
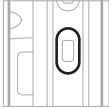
Navigation and Function Buttons

Button	Description	
	Back	Return to the previous screen.
	Home	Return to the Home screen.
	Recent Apps	View and switch between recently used apps.
	Volume	Raise or lower the volume of the speaker.
	Scan	Press right or left scan button to trigger the scanner.
	Aux	Use the Key Remap feature in the Settings app to select a button function. For example, the button could be set to initiate the push-to-talk (PTT) feature.

For button locations, see [Mobile Computer Features](#).

To learn more about how to re-map a button, see the user guide.

About Provisioning Mode

After completing the out-of-box set up process, Provisioning mode is automatically turned off. Scanning a barcode to install applications, certificates, configuration files, and licenses on the computer is restricted unless you enable Provisioning mode in the Settings app. To learn more, see the user guide.

Scan a Bar Code with the Scan Demo

Note: For optimum performance, avoid reflections by scanning the bar code at a slight angle.

1. Swipe up > **Demos** > **Scan Demo**.
2. Point the computer at the bar code.
3. Touch **Scan** on the touch screen or press and hold any **Scan** button. Center the aiming beam over the bar code.



The decode results appear on the screen.

Note: In the Scan Demo app, not all bar code symbologies are enabled by default. If a bar code does not scan, the correct symbology may not be enabled. To learn how to modify the default app settings, see the user guide.

Sync Data

To move files between your CN80 and a computer:

1. Connect the CN80 to your computer using a USB charge/communication accessory.
2. On the CN80, swipe down from the top of the screen to see the notifications panel.
3. Touch the Android System notification twice to open the options menu.
4. Select either **File Transfer** or **PTP**.
5. Open the file browser on your computer.
6. Browse to the CN80. You can now copy, delete, and move files or folders between your computer and CN80 as you would with any other storage drive (e.g., cut and paste or drag and drop).

Note: *When Provisioning mode is turned off, some folders are hidden from view in the file browser.*

Restart the Mobile Computer

You may need to restart the mobile computer to correct conditions where an application stops responding to the system or the computer seems to be locked up.

1. Press and hold the **Power** button until the options menu appears.
2. Select **Restart**.

To restart the computer if the touch panel display is unresponsive:

- Press and hold the **Power** button for approximately 8 seconds until the computer restarts.

Note: To learn about advanced reset options, see the user guide.

Support

To search our knowledge base for a solution or log into the Technical Support Portal and report a problem, go to honeywell.com/PSStechnicalsupport.

User Documentation

For the user guide and other documentation, go to sps.honeywell.com.

Limited Warranty

For warranty information, go to sps.honeywell.com and click **Support** > **Productivity** > **Warranties**.

Patents

For patent information, see www.hsmpats.com.

Trademarks

Android is a trademark of Google LLC.

Other product names or marks mentioned in this document may be trademarks or registered trademarks of other companies and are property of their respective owners.

Disclaimer

Honeywell International Inc. (“HII”) reserves the right to make changes in specifications and other information contained in this document without prior notice, and the reader should in all cases consult HII to determine whether any such changes have been made. HII makes no representation or warranties regarding the information provided in this publication.

HII shall not be liable for technical or editorial errors or omissions contained herein; nor for incidental or consequential damages resulting from the furnishing, performance, or use of this material. HII disclaims all responsibility for the selection and use of software and/or hardware to achieve intended results.

This document contains proprietary information that is protected by copyright. All rights are reserved. No part of this document may be photocopied, reproduced, or translated into another language without the prior written consent of HII.

Copyright © 2023 Honeywell Group of Companies. All rights reserved.