



CT30 XP Series

powered by Android™

Quick Start Guide

Agency Models

CT30 XP Series: CT30PX0N, CT30PL0N, CT30PL1N, CT30PL1NA

Note: *Due to variations in model configurations, your computer may appear different than illustrated.*

Out of the Box

Make sure that your shipping box contains these items:

- CT30 XP mobile computer
- Rechargeable Li-ion battery
- Hand strap (model dependent)
- USB Type-C cable (model dependent)
- Product documentation

If you ordered accessories for your mobile computer, verify that they are also included with the order. Be sure to keep the original packaging in case you need to return the mobile computer for service.

Note: *CT30PX0N and CT30PL0N models do not include a WWAN radio.*

Memory Card Specifications

Honeywell recommends the use of Single Level Cell (SLC) industrial grade microSD™, microSDHC™ or microSDXC™ memory cards with mobile computers for maximum performance and durability. Contact a Honeywell sales representative for additional information on qualified memory card options.

Computer Features

Note: Due to variations in model configurations, your computer may appear different than illustrated.

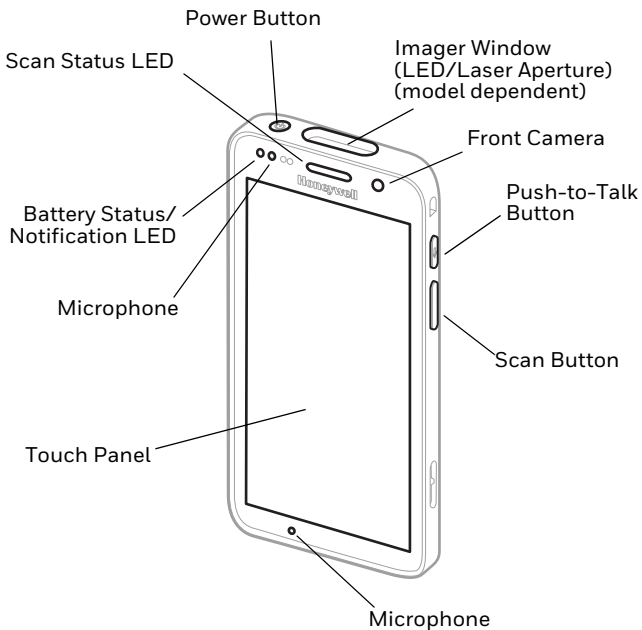

Note: Hand strap not shown.

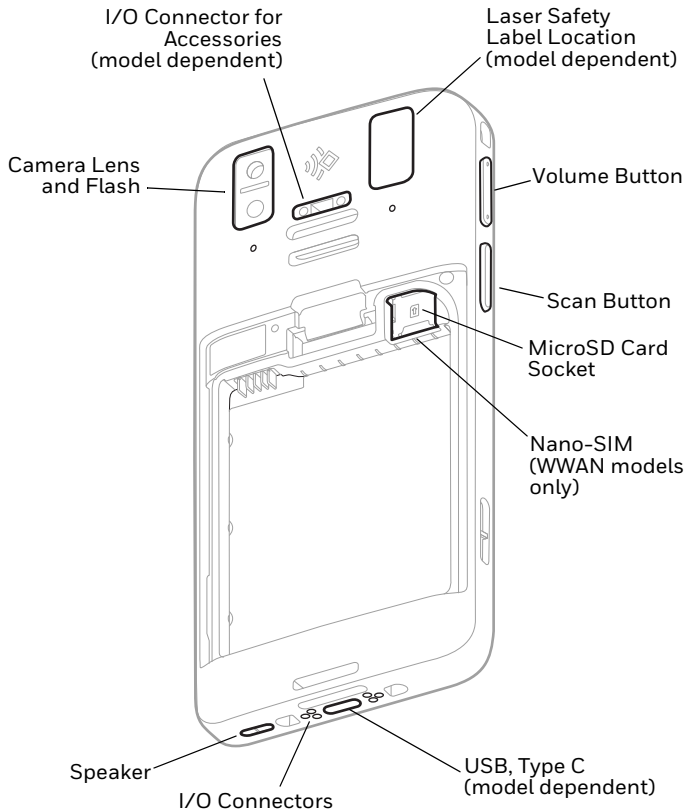

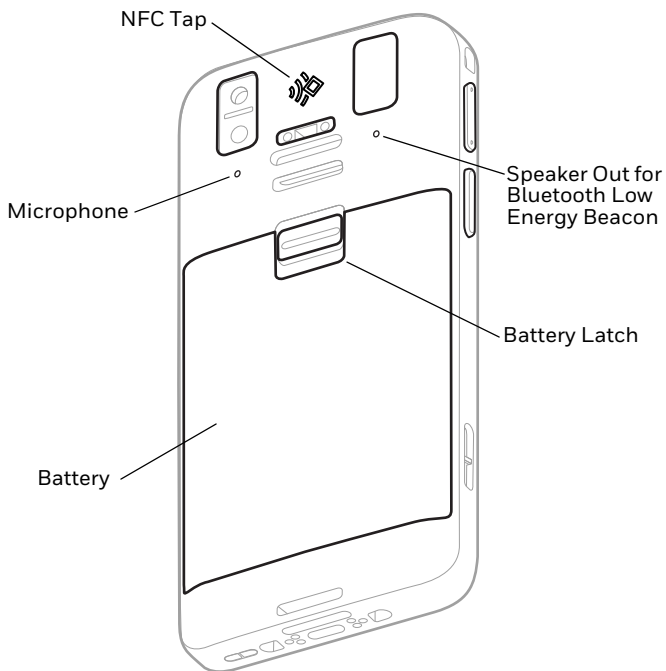

Install a Nano-SIM Card (WWAN Models)

Either a nano-SIM card or embedded SIM (eSIM) is used to activate the phone and connect to a mobile network. eSIM is available on select models only. Refer to the user guide for additional information.

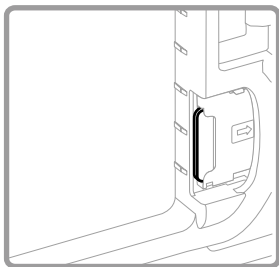
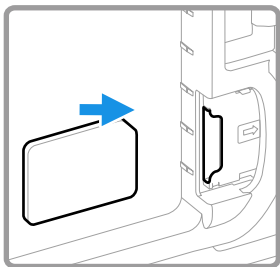

Install a microSD Card (Optional)

Note: Format the microSD card before initial use.

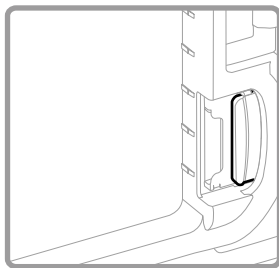
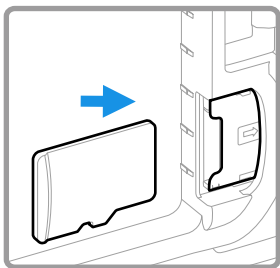

Note: Always power off the computer before attempting to install or remove a card.

About the Battery

The mobile computer ships with a 3.85 VDC, 15.5 watt-hour Li-ion battery manufactured for Honeywell International Inc.



We recommend use of Honeywell Li-ion battery packs. Use of any non-Honeywell battery may result in damage not covered by the warranty.

Nous recommandons l'utilisation de batteries Li-ion de la marque Honeywell. L'utilisation d'une batterie d'un autre fabricant est susceptible de provoquer des dommages non couverts par la garantie.



Ensure all components are dry prior to placing the battery in the computer. Mating wet components may cause damage not covered by the warranty.

Assurez-vous que tous les composants sont secs avant d'insérer la batterie dans l'ordinateur. L'insertion de composants humides risque de provoquer des dommages non couverts par la garantie.



Before you attempt to use, charge or replace the battery in the device, carefully read all labels, markings and product documentation provided in the box or online at sps.honeywell.com. To learn more about Battery Maintenance for Portable Devices, go to honeywell.com/PSS-BatteryMaintenance.

Avant d'essayer d'utiliser, de charger ou de remplacer la batterie de l'appareil, lisez attentivement toutes les étiquettes, marquages et documentation du produit fournis dans la boîte ou en ligne à sps.honeywell.com. Pour en savoir plus sur l'Entretien de Batteries pour Appareils Portables, consultez-le honeywell.com/PSS-BatteryMaintenance.

Install Battery

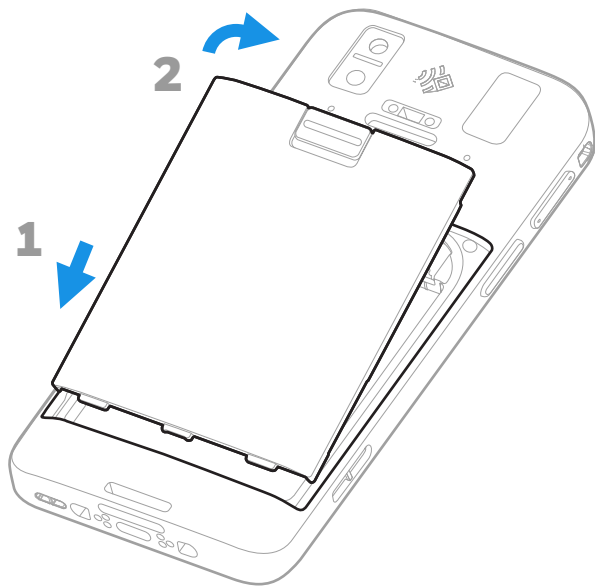

Install the Hand Strap (model dependent)

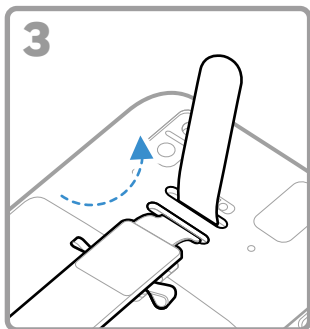
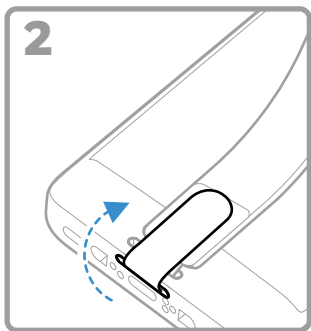
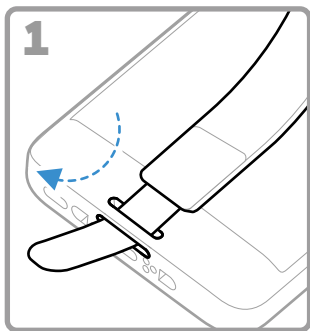

Charge the Mobile Computer

The mobile computer ships with a partially charged battery. Charge the battery with a CT30 XP charging device for a minimum of **3 hours**.

Note: *Using the computer while charging the battery increases the time required to reach a full charge. If the mobile computer is drawing more current than supplied by the charging source, charging will not take place.*



We recommend the use of Honeywell accessories and power adapters. Use of any non-Honeywell accessories or power adapters may cause damage not covered by the warranty.

Nous recommandons d'utiliser des accessoires et des adaptateurs secteur de marque Honeywell.

L'utilisation de tout accessoire ou adaptateur secteur d'une autre marque est susceptible de provoquer des dommages non couverts par la garantie.

CT30 XP series mobile computers are designed for use with CT30 XP charging accessories. For more information, see the CT30 XP *Accessory Guide* available for download at sps.honeywell.com.



Ensure all components are dry prior to mating the computers and batteries with peripheral devices. Mating wet components may cause damage not covered by the warranty.

Assurez-vous que tous les composants sont secs avant de raccorder les ordinateurs et les batteries à des périphériques. L'insertion de composants humides risque de provoquer des dommages non couverts par la garantie.

About the USB Type C Connector (model dependent)

You can use a USB cable to charge the mobile computer from a host device (e.g., laptop or desktop computer). The connected host device must supply a minimum power output of 5V, 0.5A to the CT30 XP or the battery will not charge.

Turn Power On/Off

The first time you power on the computer, a Welcome screen appears. You can either scan a configuration barcode or use the Wizard to manually set up the computer. Once setup is complete, the Welcome screen no longer appears on startup and Provisioning mode is automatically turned off (disabled).

To turn the computer on:

- Press and hold the **Power** button for approximately 3 seconds and then release.

To turn the computer off:

1. Press and hold the **Power** button until the options menu appears.
2. Touch **Power > Power Off**.

Battery Replacement

Before removing the battery, always do one of the following:

- Power off the computer.
- Place the unit in Swap Battery mode.

Swap Battery Mode

Swap Battery mode places the computer in a low power state so that the battery can be removed for a short time.

To activate Swap Battery mode:

1. Press and hold the **Power** button until the options menu appears.
2. Touch **Swap Battery** and follow the on-screen instructions.
3. Once you replace the battery, press the **Power** button.

Screen Timeout

The screen timeout (sleep mode) automatically turns the touch panel display off and locks the computer to save battery power when the computer is inactive for a programmed period of time.

- Press and release the **Power** button to wake the computer.

Adjust the Screen Timeout

To adjust the amount of time before the display sleeps after inactivity:

1. Swipe up on the touch screen.
2. Select **Settings > Display > Screen Timeout**.
3. Select the amount of time before the display goes to sleep.

About the Home Screen

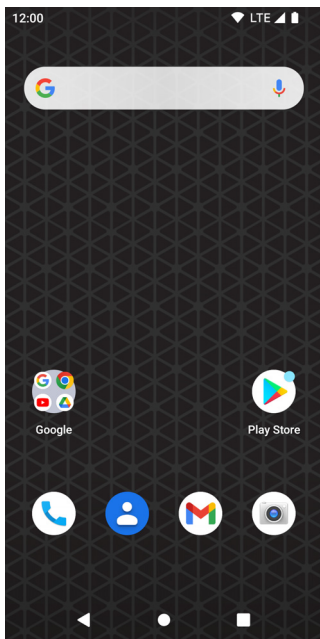

Notification /
Status Bar

Search Bar







Home Screen Panel

Favorites Tray

Navigation Buttons

Navigation and Function Buttons

For button locations, see [Computer Features](#) on page 2.

| Button | Description | |
|---|--------------|---|
|  | Back | Return to the previous screen. |
|  | Home | Return to the Home screen. |
|  | Recent Apps | View and switch between recently used apps. |
|  | Volume | Press the top of the button to raise the speaker volume. Press the bottom of the button to lower the speaker volume. |
|  | Scan | Press left or right Scan button to trigger the scanner. |
|  | Push-to-Talk | Push-to-Talk button for use with apps that support the feature for voice over IP (VoIP) calls over Wi-Fi or cellular data network connections. |
|  | Power | <ul style="list-style-type: none">• Turn Power On/Off• Enter/Exit Screen Timeout (sleep).• Access options menu, including: Power off, Restart, and Swap Battery Mode. |

About Provisioning Mode (model dependent)

After completing the out-of-box set up process, Provisioning mode is automatically turned off. Scanning a barcode to install applications, certificates, configuration files, and licenses on the computer is restricted unless you enable Provisioning mode in the Settings app. To learn more, see the user guide.

Scan a Barcode with the Scan Demo

For optimum performance, avoid reflections by scanning the barcode at a slight angle.

1. Swipe up on the screen.
2. Select **Demos > Scan Demo**.
3. Point the computer at the barcode.
4. Touch **Scan** on the screen or press and hold any Scan button. Center the aiming beam over the barcode.

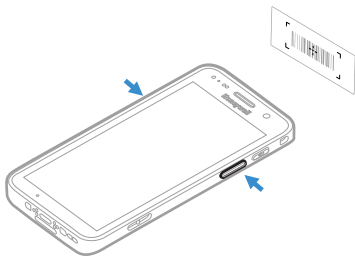

The decode results appear on the screen.

Note: *In the Scan Demo app, not all barcode symbologies are enabled by default. If a barcode does not scan, the correct symbology may not be enabled. To learn how to modify the default app settings, see the user guide.*

Sync Data

To move files between your CT30 XP and a computer:

1. Connect the CT30 XP to your computer using a USB charge/communication accessory.
2. On the CT30 XP, swipe down from the top of the screen to see the notifications panel.
3. Touch the **Android System** notification twice to open the options menu.
4. Select either **File Transfer** or **PTP**.
5. Open the file browser on your computer.
6. Browse to the CT30 XP. You can now copy, delete, and move files or folders between your computer and CT30 XP as you would with any other storage drive (e.g., cut and paste or drag and drop).

Note: *When Provisioning mode is turned off, some folders are hidden from view in the file browser.*

Restart the Mobile Computer

You may need to restart the mobile computer to correct conditions where an application stops responding to the system or the computer seems to be locked up.

1. Press and hold the **Power** button until the options menu appears.
2. Select **Power > Restart**.

To restart the computer if the touch panel display is unresponsive:

- Press and hold the **Power** button for approximately 8 seconds until the computer restarts.

Note: *To learn about advanced reset options, see the user guide.*

Support

Go to sps.honeywell.com and select **Support** to search our knowledge base for a solution or to log into the Technical Support portal.

Documentation

Product documentation is available at sps.honeywell.com.

Limited Warranty

For warranty information, go to sps.honeywell.com and then select **Support > Warranties**.

Patents

For patent information, see www.hsmpats.com.

Trademarks

Android is a trademark of Google LLC.

Disclaimer

Honeywell International Inc. (“HII”) reserves the right to make changes in specifications and other information contained in this document without prior notice, and the reader should in all cases consult HII to determine whether any such changes have been made. HII makes no representation or warranties regarding the information provided in this publication.

HII shall not be liable for technical or editorial errors or omissions contained herein; nor for incidental or consequential damages resulting from the furnishing, performance, or use of this material. HII disclaims all responsibility for the selection and use of software and/or hardware to achieve intended results.

This document contains proprietary information that is protected by copyright. All rights are reserved. No part of this document may be photocopied, reproduced, or translated into another language without the prior written consent of HII.

Copyright © 2023 Honeywell Group of Companies. All rights reserved.