



# Dolphin CN80 NI/CN80G

---

powered by Android™

## Quick Start Guide



CN80NI-A7-EN-QS Rev F  
09/20

## Introduction

This document is only for Dolphin CN80 NI and CN80G mobile computers marked as certified for use in non-incendive (NI) environments. CN80/CN80G models can be identified by NI markings on the device label verifying non-incendive certification.



**Warning: Explosion Hazard –Substitution of components may impair suitability for Division 2 Class I, II, III locations.**

**Avertissement: Risque d' explosion – Le remplacement de composants risque de compromettre l'adaptation du produit aux sites de division 2 catégorie I, II, III.**

## Out of the Box

Make sure that your shipping box contains these items:

- Dolphin CN80 NI or CN80G mobile computer
- Dust Cover
- Rechargeable 3.85 VDC Li-ion battery\*
- Hand strap, stylus and tether
- Product documentation

If you ordered accessories for your mobile computer, verify that they are also included with the order. Be sure to keep the original packaging in case you need to return the mobile computer for service.

## Memory Card Specifications

Honeywell recommends the use of Single Level Cell (SLC) industrial grade microSD™ or microSDHC™ memory cards with CN80 mobile computers for maximum performance and durability. Contact a Honeywell sales representative for additional information on qualified memory card options.

\* Battery shipped separately for all Dolphin CN80G models.

# Mobile Computer Features

## CN80/CN80G Models with 6603ER Imager

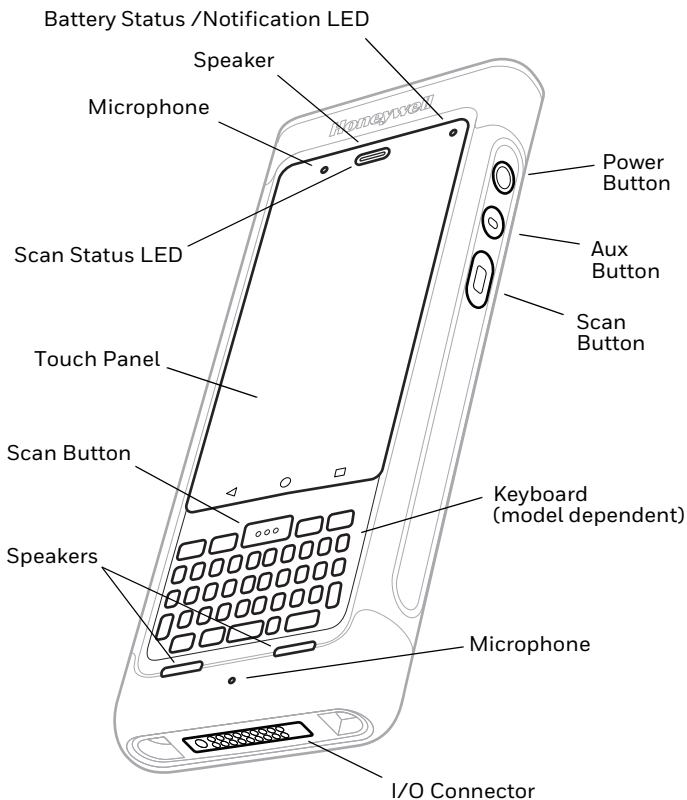

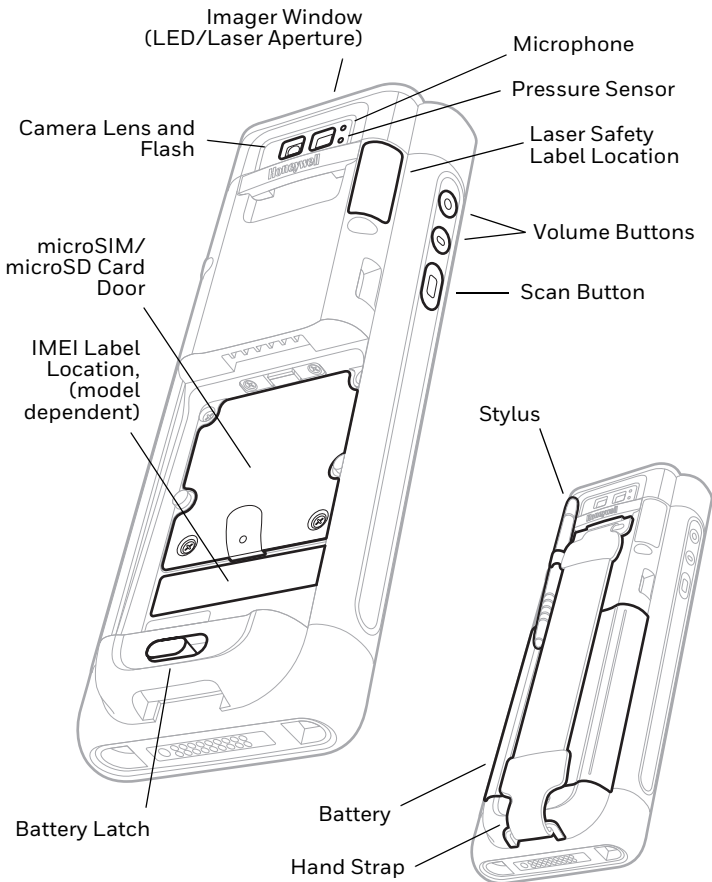

## CN80/CN80G Models with EX20 Near/Far Imager

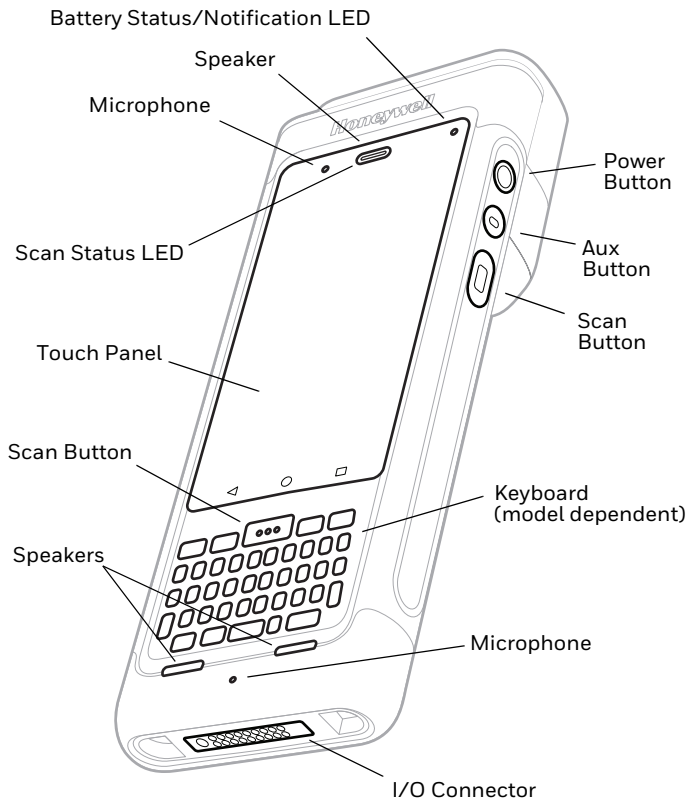

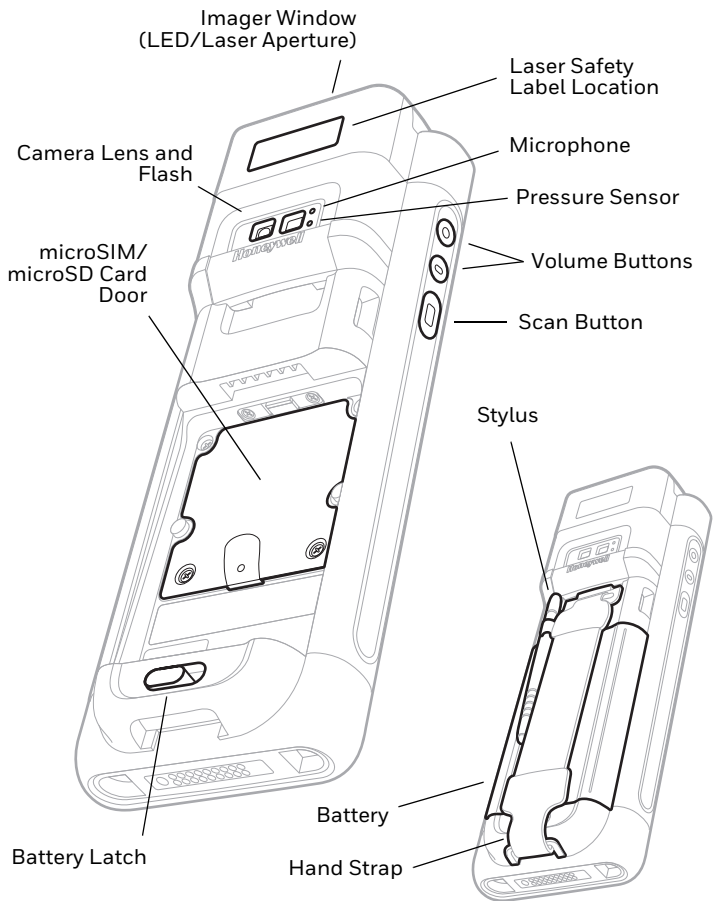

# Install a microSIM Card / Install a microSD Card



**Always power off the computer before attempting to install or remove a card.**

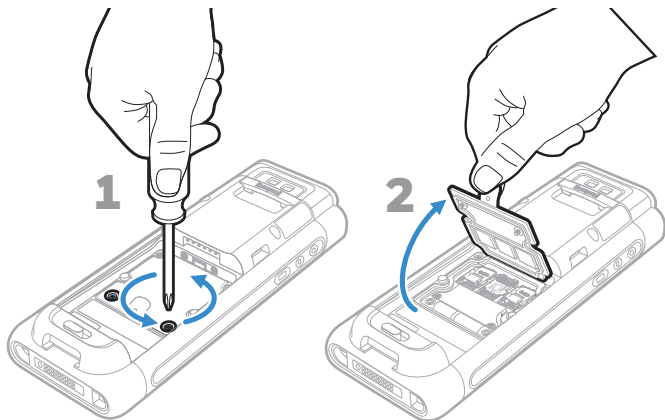

## SIM 1

Phone feature is available only on CN80L1N models.

On all models, when using a UICC card for NFC Secure Element link encryption, install the card in SIM slot 1.

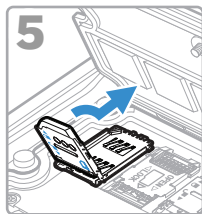
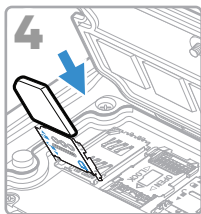
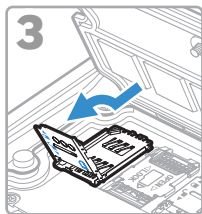

## SIM 2

SIM 2 feature is available only on CN80L1N models.

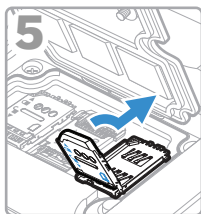
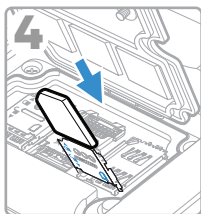
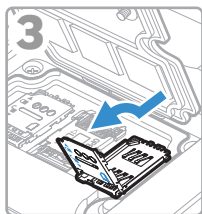

## microSD

Format the microSD card before initial use.

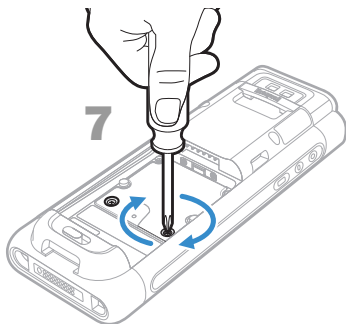
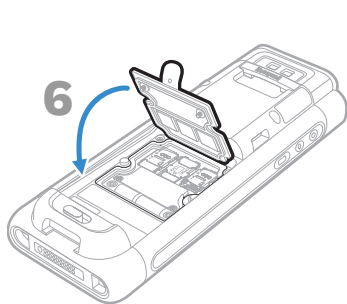
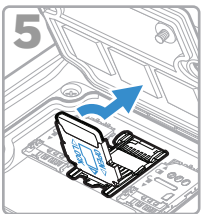
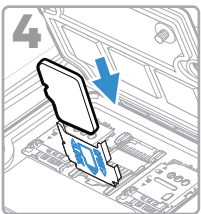
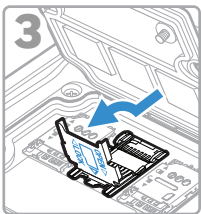



## Install the Battery

CN80 and CN80G mobile computers use a Li-ion 3.85 VDC, 22.3 watt-hour battery manufactured for Honeywell International Inc. The CN80G battery is packaged and shipped separately from the mobile computer. The CN80 NI battery ships with the mobile computer.

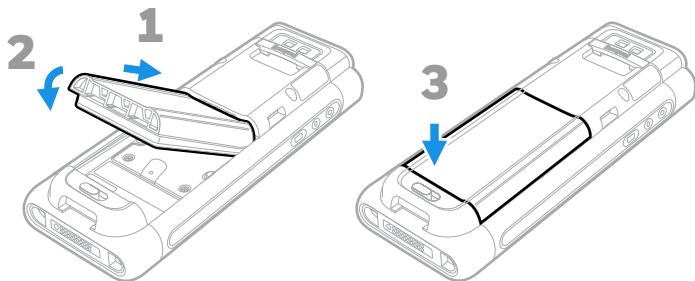

**Ensure all components are dry prior to placing the battery in the computer. Mating wet components may cause damage not covered by the warranty.**

## Install the Hand Strap

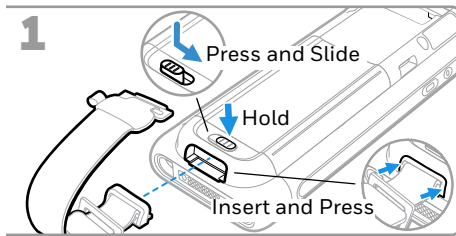

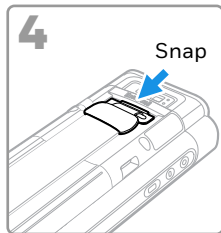
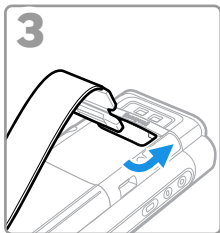
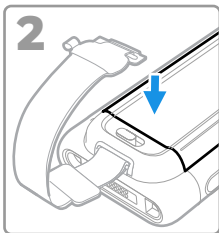

## Charge the Mobile Computer



**Warning: Explosion Hazard - Batteries must only be changed or charged in an area known to be non-hazardous. Use ONLY Honeywell battery part number CX80-BAT-EXT-WRLS1 for CN80 NI models or CX80G-BAT-EXT-WRLS for CN80G models.**

**Risqué d'explosion - Les batteries doivent uniquement être remplacées ou rechargées dans un endroit non dangereux. Utilisez UNIQUEMENT Honeywell batterie P/N CX80-BAT-EXT-WRLS1 pour les modèles CN80 ou P/N CX80G-BAT-EXT-WRLS pour les modèles CN80G.**

The battery ships with only a partial charge. Before initial use, charge the battery with a Honeywell charging device for a minimum of **4 hours**. Using the computer while charging the battery increases the time required to reach a full charge.



**We recommend the use of Honeywell accessories and power adapters. Use of any non-Honeywell accessories or power adapters may cause damage not covered by the warranty.**

CN80 mobile computers are designed for use with CX80 Series charging accessories. CN80G models are designed for use with CN80G charging accessories.



**Ensure all components are dry prior to mating the computers and batteries with peripheral devices. Mating wet components may cause damage not covered by the warranty.**

## Install the optional Dust Cover

The dust cover can be used when additional I/O connector shielding is desired.

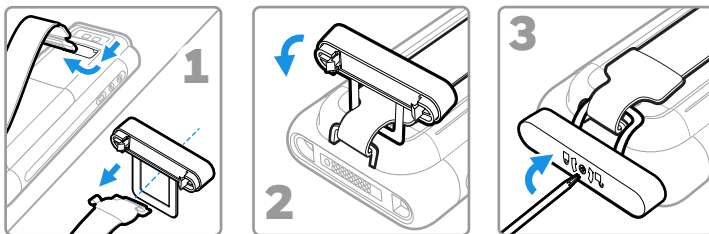

## Turn Power On/Off

The first time you power on the computer, a Welcome screen appears. You can either scan a configuration bar code or use the Wizard to manually set up the computer. Once setup is complete, the Welcome screen no longer appears on startup and Provisioning mode is automatically turned off (disabled).

To turn the computer on:

- Press and hold the **Power** button for approximately 3 seconds, and then release.

To turn the computer off:

1. Press and hold the **Power** button until the options menu appears.
2. Touch **Power Off**.

## Sleep Mode

Sleep mode automatically turns the touch panel display off and locks the computer to save battery power when the computer is inactive for a programmed period of time.

1. Press and release the **Power** button to wake the computer.
2. Drag the  toward the top of the display to unlock the computer.

## Unlock the Dust Cover

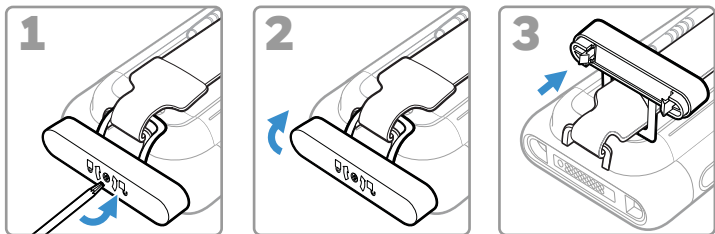

## Swap Battery Mode for Battery Replacement

You should always place the computer in Swap Battery mode before removing the battery. Swap Battery mode places the computer in a low power state so that the battery can be removed for a short time.

To activate Swap Battery mode:





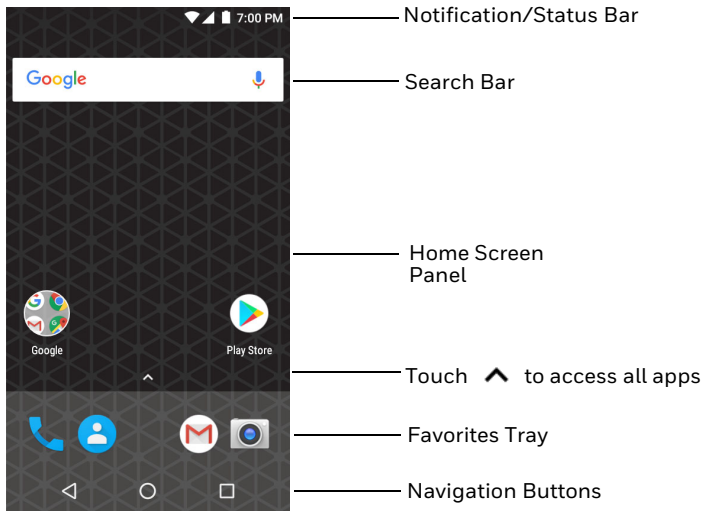

1. Press and hold the **Power** button until the options menu appears.
2. Touch **Swap Battery** and follow the on-screen instructions.
3. Once you replace the battery, press the **Power** button.

## About the Home Screen



To learn how to customize the Home screen, see the user guide.

## Navigation and Function Buttons

Button	Description	
	Back	Return to the previous screen.
	Home	Return to the Home screen.
	Recent Apps	View and switch between recently used apps.
	Volume	Raise or lower the volume of the speaker.
	Scan	Press right or left scan button to trigger the scanner.
	Aux	Use the Key Remap feature in the Settings app to select a button function. For example, the button could be set to initiate the push-to-talk (PTT) feature.

For button locations, see [Mobile Computer Features](#).

To learn more about how to re-map a button, see the user guide.

## Scan a Bar Code

For optimum performance, avoid reflections by scanning the bar code at a slight angle.

1. Point the computer at the bar code.
2. Press and hold any **Scan** button. Center the aiming beam over the bar code.

**Note:** *Not all bar code symbologies are enabled by default. If a bar code does not scan, the correct symbology may not be enabled or Provisioning mode may be turned off. To learn how to modify default settings, see the user guide.*

## About Provisioning Mode

After completing the out-of-box set up process, Provisioning mode is automatically turned off. Scanning a bar code to install applications, certificates, configuration files, and licenses on the computer is restricted unless you enable Provisioning mode in the Settings app. To learn more, see the user guide.

## Restart the Mobile Computer

You may need to restart the mobile computer to correct conditions where an application stops responding to the system or the computer seems to be locked up.

1. Press and hold the **Power** button until the options menu appears.
2. Select **Reboot**. If prompted to verify, select **OK**.

To restart the computer if the touch panel display is unresponsive:

- Press and hold the **Power** button for approximately 8 seconds until the computer restarts.

**Note:** *To learn about advanced reset options, see the user guide.*

## Support

To search our knowledge base for a solution or log into the Technical Support Portal and report a problem, go to [www.hsmcontactsupport.com](http://www.hsmcontactsupport.com).

## Documentation

Product documentation is available at [www.honeywellaidc.com](http://www.honeywellaidc.com).

## Limited Warranty

For warranty information, go to [www.honeywellaidc.com](http://www.honeywellaidc.com) and click **Get Resources > Product Warranty**.

## Patents

For patent information, see [www.hsmpats.com](http://www.hsmpats.com).

## Trademarks

Android is a trademark of Google LLC.

Windows is either a registered trademark or registered trademark of Microsoft Corporation in the United States and/or other countries.

## Disclaimer

Honeywell International Inc. (“HII”) reserves the right to make changes in specifications and other information contained in this document without prior notice, and the reader should in all cases consult HII to determine whether any such changes have been made. The information in this publication does not represent a commitment on the part of HII.

HII shall not be liable for technical or editorial errors or omissions contained herein; nor for incidental or consequential damages resulting from the furnishing, performance, or use of this material. HII disclaims all responsibility for the selection and use of software and/or hardware to achieve intended results.



This document contains proprietary information that is protected by copyright. All rights are reserved. No part of this document may be photocopied, reproduced, or translated into another language without the prior written consent of HII.

Copyright © 2018-2020 Honeywell International Inc. All rights reserved.