



# CW45

---

powered by Android™

## Quick Start Guide

# Agency Models

CW45-X0N

## Out of the Box

Make sure that your shipping box contains these items:

- CW45 mobile computer
- Arm mount
- Rechargeable Li-ion battery
- Product documentation

**Note:** Arm strap (CW45-STRAP/CW45-STRAP-HL) sold separately.

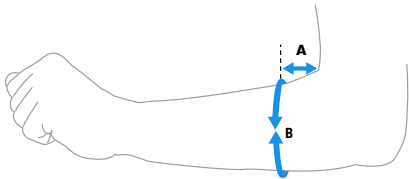

Strap		A	B
CW45-STRAP Small	in.	3	8 to 10.5
	cm	7.6	20.3 to 26.7
CW45-STRAP Medium	in.	3	10 to 13.5
	cm	7.6	25.4 to 34.3
CW45-STRAP Large	in.	3	11.5 to 15
	cm	7.6	29.2 to 38.1
CW45-STRAP-HL	in.	3	8 to 15
	cm	7.6	20.3 to 38.1

If you ordered accessories for your mobile computer, verify that they are also included with the order. Be sure to keep the original packaging in case you need to return the mobile computer for service.

## Computer Features

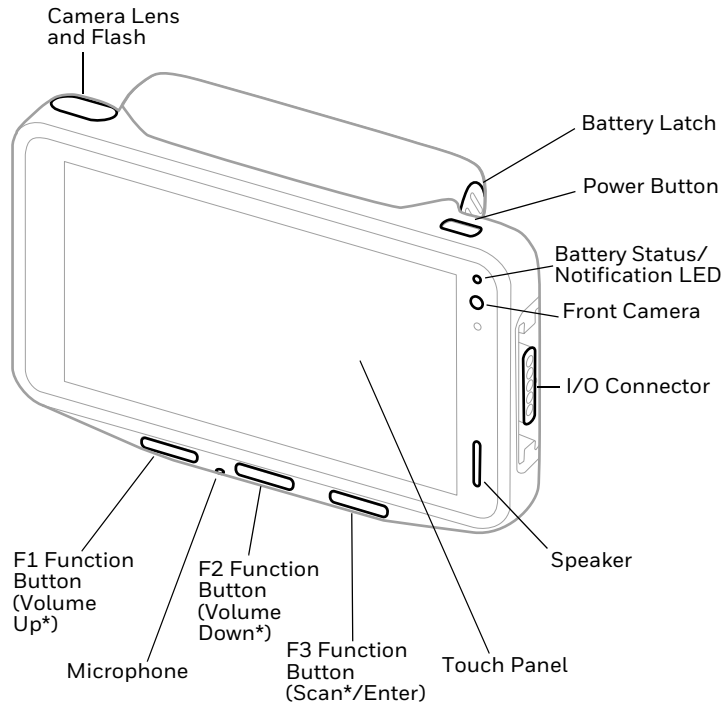

\*Out-of-box configuration

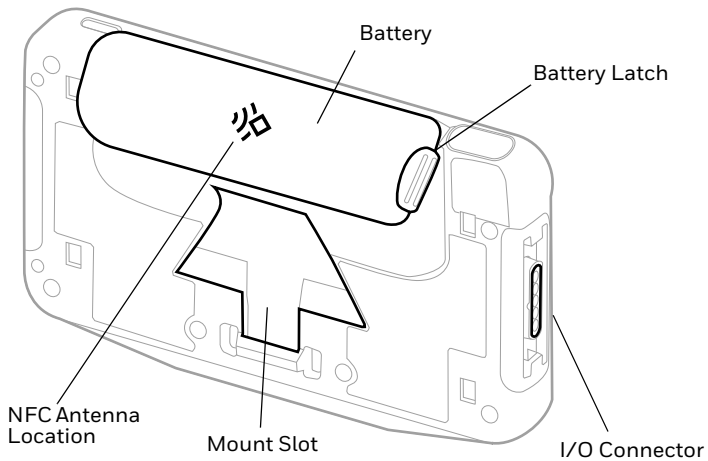

## Mount Features

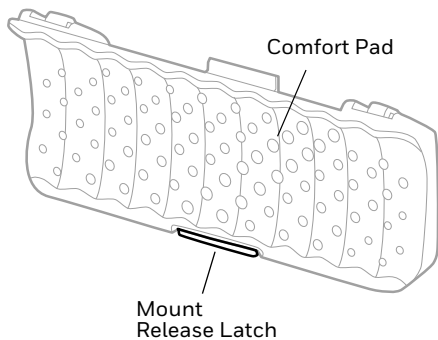
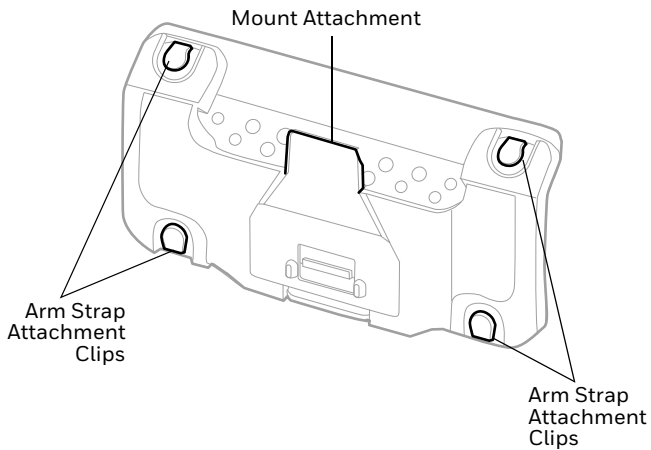

## About the Battery

The mobile computer ships with either a standard 3.6 VDC, 12.24 watt-hour Li-ion standard battery or an extended 3.6 VDC, 24.48 watt-hour Li-ion battery manufactured for Honeywell International Inc.



**Before you attempt to use, charge or replace the battery in the device, carefully read all labels, markings and product documentation provided in the box or online at [sps.honeywell.com](https://sps.honeywell.com). To learn more about Battery Maintenance for Portable Devices, go to [honeywell.com/PSS-BatteryMaintenance](https://honeywell.com/PSS-BatteryMaintenance).**

**Avant d'essayer d'utiliser, de charger ou de remplacer la batterie de l'appareil, lisez attentivement toutes les étiquettes, marquages et documentation du produit fournis dans la boîte ou en ligne à [sps.honeywell.com](https://sps.honeywell.com). Pour en savoir plus sur l'Entretien de Batteries pour Appareils Portables, consultez-le [honeywell.com/PSS-BatteryMaintenance](https://honeywell.com/PSS-BatteryMaintenance).**



**We recommend use of Honeywell Li-ion battery packs. Use of any non-Honeywell battery may result in damage not covered by the warranty.**

**Nous recommandons l'utilisation de batteries Li-ion de la marque Honeywell. L'utilisation d'une batterie d'un autre fabricant est susceptible de provoquer des dommages non couverts par la garantie.**



**Ensure all components are dry prior to placing the battery in the computer. Mating wet components may cause damage not covered by the warranty.**

**Assurez-vous que tous les composants sont secs avant d'insérer la batterie dans l'ordinateur. L'insertion de composants humides risque de provoquer des dommages non couverts par la garantie.**

## Install the Battery

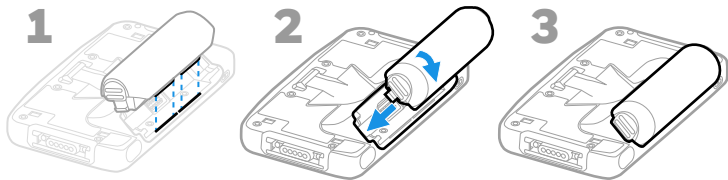

**Note:** Battery can be installed with or without the mount in place.

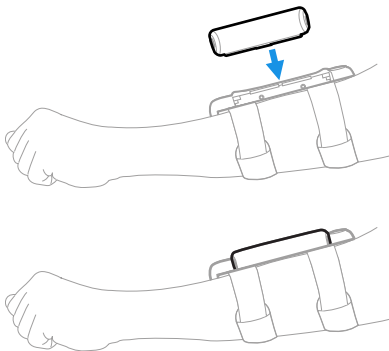

# Assemble the Mount and Arm Strap

## CW45-STRAP

1

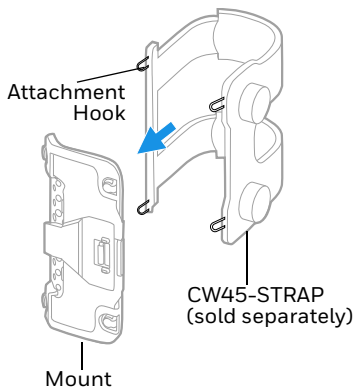

2

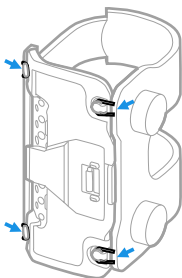



3

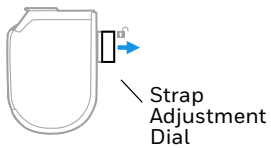

4

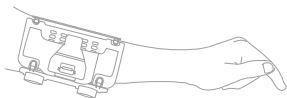

**Left Arm Setup**

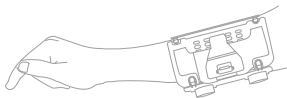

**Right Arm Setup**

5

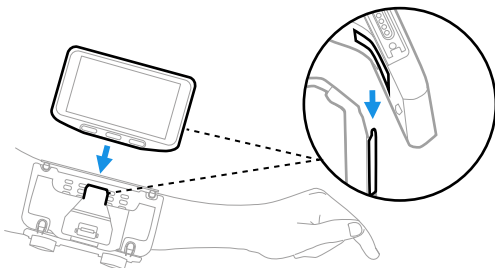

6

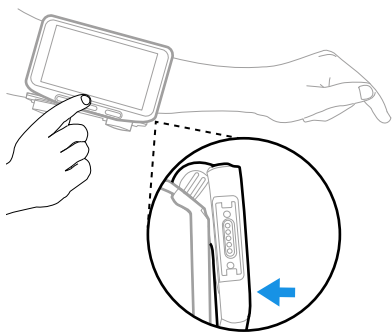

7

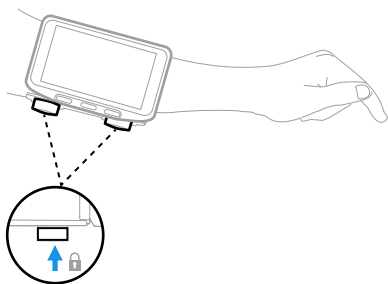

8

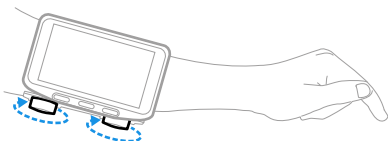

# CW45-STRAP-HL

## 1

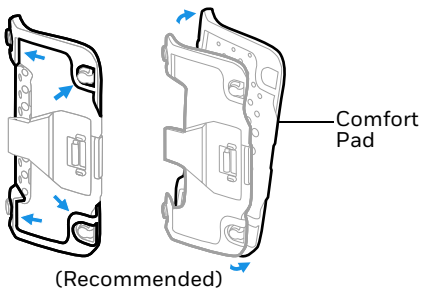

## 2

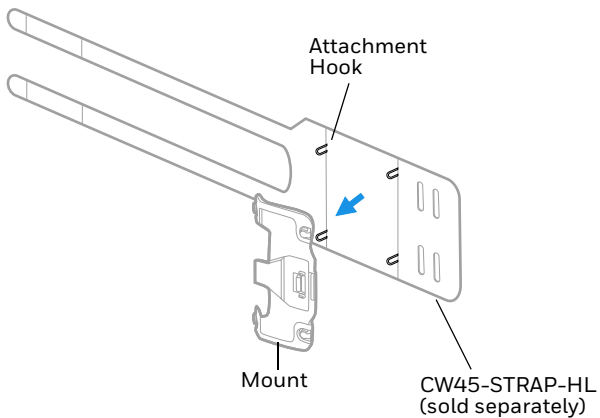

3

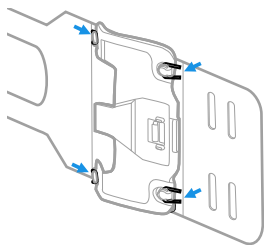

4

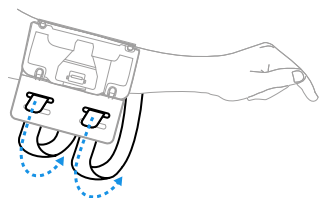

or

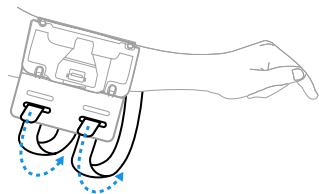

5

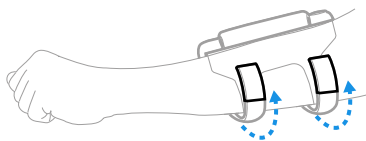

6



**Left Arm Setup**



**Right Arm Setup**

7

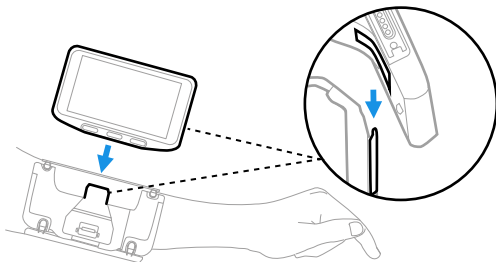

8

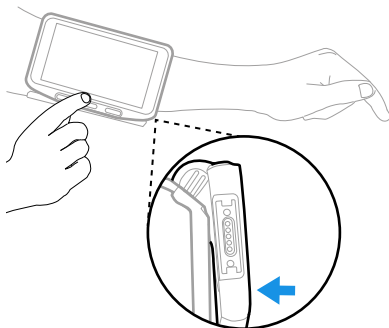

## Remove Mount Assembly

### CW45-STRAP

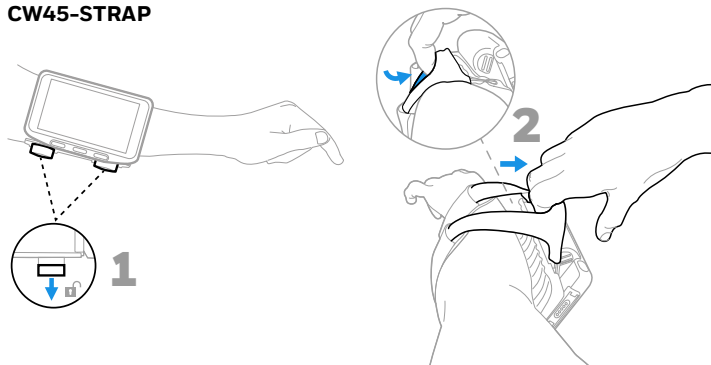

### CW45-STRAP-HL

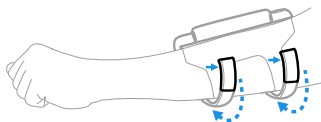

## Charge the Mobile Computer

You must charge the CW45 battery before using the computer for the first time. Charge the standard (12.24 Wh) battery with a CW45 charging device for a minimum of **3 hours**. Charge the extended (24.48 Wh) battery a minimum of **6 hours**.

**Note:** *Using the computer while charging the battery increases the time required to reach a full charge. If the mobile computer is drawing more current than supplied by the charging source, charging will not take place.*



**We recommend the use of Honeywell accessories and power adapters. Use of any non-Honeywell accessories or power adapters may cause damage not covered by the warranty.**

**Nous recommandons d'utiliser des accessoires et des adaptateurs secteur de marque Honeywell.**

**L'utilisation de tout accessoire ou adaptateur secteur d'une autre marque est susceptible de provoquer des dommages non couverts par la garantie.**

CW45 series mobile computers are designed for use with CW45 charging accessories. For more information, see the CW45 *Accessories User Guide* available for download at [sps.honeywell.com](http://sps.honeywell.com).



**Ensure all components are dry prior to mating the computers and batteries with peripheral devices. Mating wet components may cause damage not covered by the warranty.**

**Assurez-vous que tous les composants sont secs avant de raccorder les ordinateurs et les batteries à des périphériques. L'insertion de composants humides risque de provoquer des dommages non couverts par la garantie.**

## Turn Power On/Off

The first time you power on the computer, a Welcome screen appears. You can either scan a configuration barcode or use the Wizard to manually set up the computer. Once setup is complete, the Welcome screen no longer appears on startup and Provisioning mode is automatically turned off (disabled).

To turn the computer on:

- Press and hold the **Power** button for approximately 3 seconds and then release.

To turn the computer off:

1. Press and hold the **Power** button until the options menu appears.
2. Touch **Power Off**.

## Battery Replacement

### Hot Swap

You can replace the battery on demand provided the following conditions are met:

- The computer has been powered on for at least 4 minutes.
- AND
- You insert a new battery within 60 seconds.

### Swap Battery Mode

Swap Battery mode places the computer in a low power state so that the battery can be removed for a short time.

To activate Swap Battery mode:

1. Press and hold the **Power** button until the options menu appears.
2. Touch **Swap Battery** and follow the on-screen instructions.
3. Once you replace the battery, press the **Power** button.



## Remove the Battery

Press and hold the battery latches and lift the battery out of the computer.

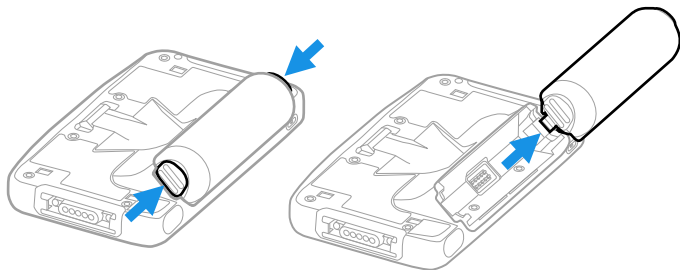

or

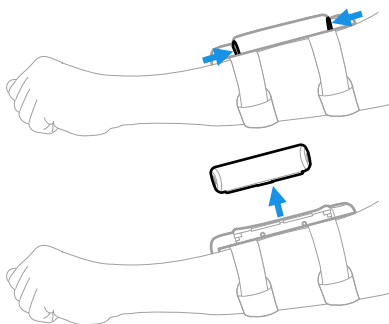

## Screen Timeout

The screen timeout (sleep mode) automatically turns the touch panel display off and locks the computer to save battery power when the computer is inactive for a programmed period of time.

- Press and release the **Power** button to wake the computer.

## Adjust the Screen Timeout

To adjust the amount of time before the display sleeps after inactivity:

1. Swipe up on the touch screen.
2. Select **Settings > Display > Screen Timeout**.
3. Select the amount of time before the display goes to sleep.

## About the Home Screen

Notification /  
Status Bar  
Search Bar

Home Screen  
Panel



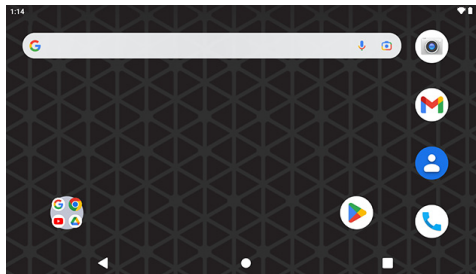



Navigation  
Buttons



Favorites  
Tray

## Navigation and Function Buttons

For button locations, see [Computer Features](#) on page 2.

Button	Description	
	Back	Return to the previous screen.
	Home	Return to the Home screen.
	Recent Apps	View and switch between recently used apps.
	Power	<ul style="list-style-type: none"><li>• <a href="#">Turn Power On/Off</a></li><li>• Enter/Exit <a href="#">Screen Timeout</a> (sleep).</li><li>• Access options menu, including: Power off, Restart, and <a href="#">Swap Battery Mode</a>.</li></ul>
	VOL_UP	Programmable function button. Default is Volume Up.
	VOL_DOWN	Programmable function button. Default is Volume Down.
	ENTER/ SCAN*	Programmable function button. Default is Enter.  *Out of the box, the F3 button is assigned to Scan (see next section).

## F3 Button

Out of the box, the F3 button has been remapped to Scan so that you can use a configuration barcode during setup. To clear the remapping and return the F3 button to its default (Enter), scan the barcode below or use Keyremap. (Refer to the CW45 User Guide for more information about Keyremap.)



**Note:** *Performing a Factory Reset will remap the F3 button back to Scan.*

## About Provisioning Mode

After completing the out-of-box set up process, Provisioning mode is automatically turned off. Scanning a barcode to install applications, certificates, configuration files, and licenses on the computer is restricted unless you enable Provisioning mode in the Settings app. To learn more, see the user guide.

## Scan a Barcode with the Scan Demo

For optimum performance, avoid reflections by scanning the barcode at a slight angle.

1. Swipe up on the screen.
2. Select **Demos > Scan Demo**.
3. Point the computer at the barcode.
4. Touch **Scan** on the screen.

The decode results appear on the screen.



**Note:** *In the Scan Demo app, not all barcode symbologies are enabled by default. If a barcode does not scan, the correct symbology may not be enabled. To learn how to modify the default app settings, see the user guide.*

## Sync Data

To move files between your CW45 and a computer:

1. Connect the CW45 to your computer using a communication accessory.
2. On the CW45, swipe down from the top of the screen to see the notifications panel.
3. Touch the **Android System** notification twice to open the options menu.

4. Select either **File Transfer** or **PTP**.
5. Open the file browser on your computer.
6. Browse to the CW45. You can now copy, delete, and move files or folders between your computer and CW45 as you would with any other storage drive (e.g., cut and paste or drag and drop).

**Note:** *When Provisioning mode is turned off, some folders are hidden from view in the file browser.*

## Restart the Mobile Computer

You may need to restart the mobile computer to correct conditions where an application stops responding to the system or the computer seems to be locked up.

1. Press and hold the **Power** button until the options menu appears.
2. Select **Restart**.

To restart the computer if the touch panel display is unresponsive:

- Press and hold the **Power** button for approximately 8 seconds until the computer restarts.

**Note:** *To learn about advanced reset options, see the user guide.*

## Compliance Version

To view compliance marks for the mobile device, select **Settings** > **About phone** > **Compliance Information**.

## Support

To search our knowledge base for a solution or log into the Technical Support Portal and report a problem, go to [honeywell.com/PSSTechnicalsupport](https://honeywell.com/PSSTechnicalsupport).

## Documentation

Product documentation is available at [sps.honeywell.com](https://sps.honeywell.com).

## Limited Warranty

For warranty information, go to [sps.honeywell.com](https://sps.honeywell.com) and then select **Support > Productivity > Warranties**.

## Patents

For patent information, see [www.hsmpats.com](https://www.hsmpats.com).

## Trademarks

Android is a trademark of Google LLC.

Other product names or marks mentioned in this document may be trademarks or registered trademarks of other companies and are property of their respective owners.

## Disclaimer

Honeywell International Inc. (“HII”) reserves the right to make changes in specifications and other information contained in this document without prior notice, and the reader should in all cases consult HII to determine whether any such changes have been made. HII makes no representation or warranties regarding the information provided in this publication.

HII shall not be liable for technical or editorial errors or omissions contained herein; nor for incidental or consequential damages resulting from the furnishing, performance, or use of

this material. HII disclaims all responsibility for the selection and use of software and/or hardware to achieve intended results.

This document contains proprietary information that is protected by copyright. All rights are reserved. No part of this document may be photocopied, reproduced, or translated into another language without the prior written consent of HII.

Copyright © 2024 Honeywell Group of Companies. All rights reserved.