

CHARACTERIZATION NOTE

AQ7CO Carbon Monoxide Gas Sensor

CONTENTS

- Document Purpose
- The Gas Response Curve
- Linearity
- Temperature Characteristics
 - Variation of Baseline Offset with Temperature
 - Variation of Sensitivity with Temperature
 - Variation of T90 with Temperature
- Long-term Characteristics
 - Long-Term Baseline Drift
 - Long-Term Sensitivity Drift
 - Long-Term T90 Drift
- Repeatability
- Calibration Guidelines
- Recommended Gas Flow Rates
- Compensation Algorithm of AQ7 Series Sensors
- Appendix 1. Compensation Parameter Table – Template
- Appendix 2. Recommended Circuit

DOCUMENT PURPOSE

The purpose of this document is to provide indicative, technical performance data for the AQ7CO sensor to assist in the integration of the sensor into gas detection instrumentation. The sensor has been subjected to a testing program as part of the development process. Within this document, detailed information on the results of this program is presented.

This document and the information contained within does not constitute a specification. The data is provided for informational purposes only and is not warranted by the manufacturer.

It should be used in conjunction with the Product Datasheet and the Product Safety Datasheet (PSDS 15.1).

NOTICE

- Ensure the sensor is powered on for a minimum of 24 hours before use.
- Sensor may experience higher failure risk when continuously exposed to 90 %RH/50°C for > 168 hours.
- All baseline tests are performed under clean dry air (Gas cylinder with a composition of 80% N₂ and 20% O₂).

AQ7CO Carbon Monoxide (CO) Gas Characterization Note

THE GAS RESPONSE CURVE

The data in Figure 1 shows a typical response curve for the AQ7CO. Test data was taken from current production at the time of release of this document, and reflects the typical performance of a production batch.

The data in Figures 2 and 3 shows typical response and recovery profiles based on the data above.

Figure 1. AQ7CO Gas Response and Recovery Profile

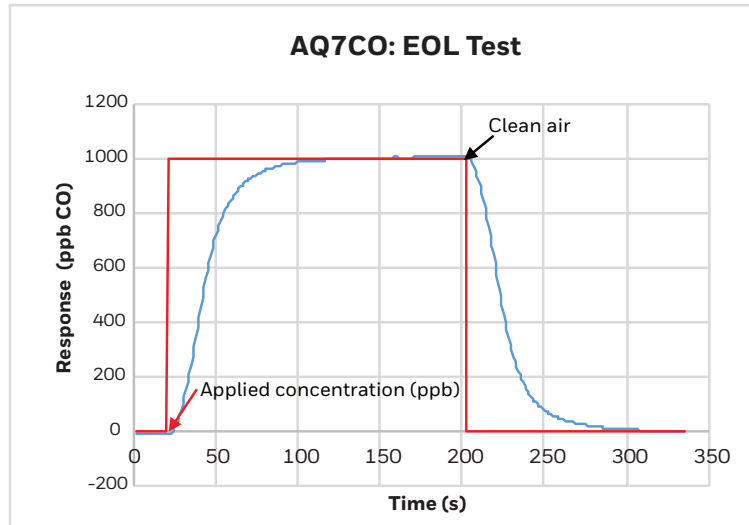

Figure 2. AQ7CO Gas Response Profile

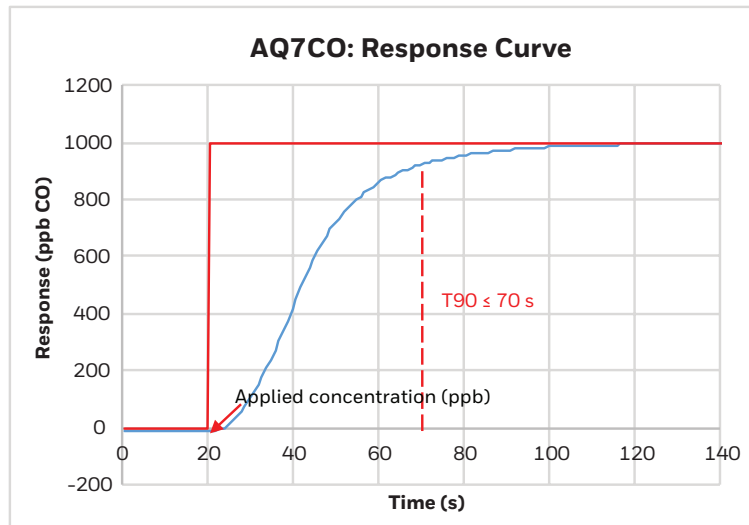
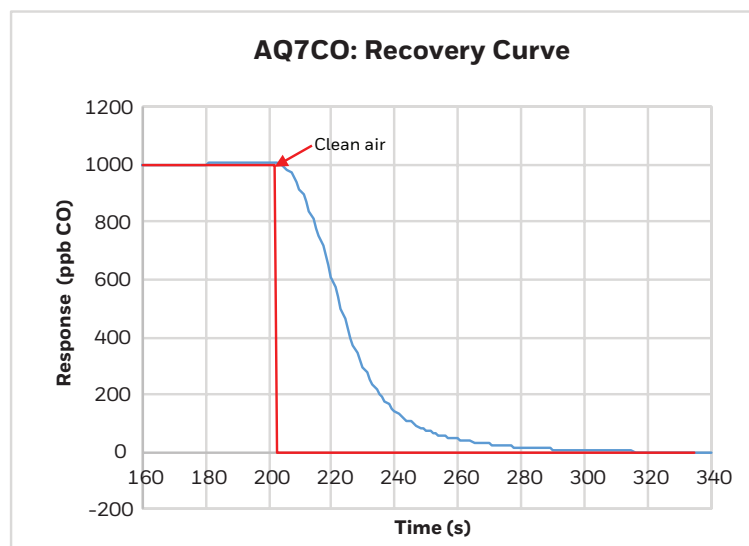

Figure 3. AQ7CO Gas Recovery Profile



AQ7CO Carbon Monoxide (CO) Gas Characterization Note

LINEARITY

The data in Figure 4 shows the typical linearity performance of the AQ7CO sensor when subjected to differing carbon monoxide concentrations which is 0 ppb to 1000 ppb.

Figure 4. Linearity from 0 ppb to 1000 ppb

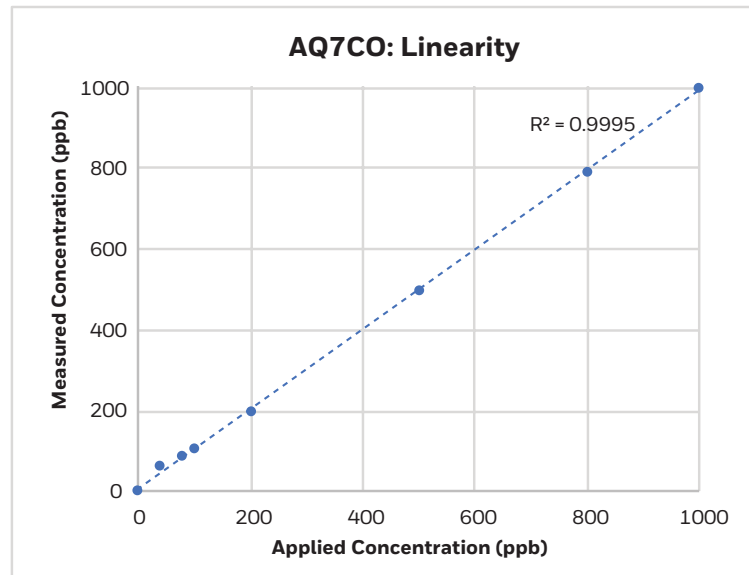

AQ7CO Carbon Monoxide (CO) Gas Characterization Note

TEMPERATURE CHARACTERISTICS

Variation of Baseline Offset with Temperature

The electrical output in the absence of target gas (baseline offset) of the AQ7CO will vary as a function of the temperature.

The data on the right shows typical AQ7CO performance across the operating temperature range, for sensors calibrated at 20°C with clean air.

The presented results reflect the typical performance of a production batch.

Figure 5. Baseline vs. Temperature

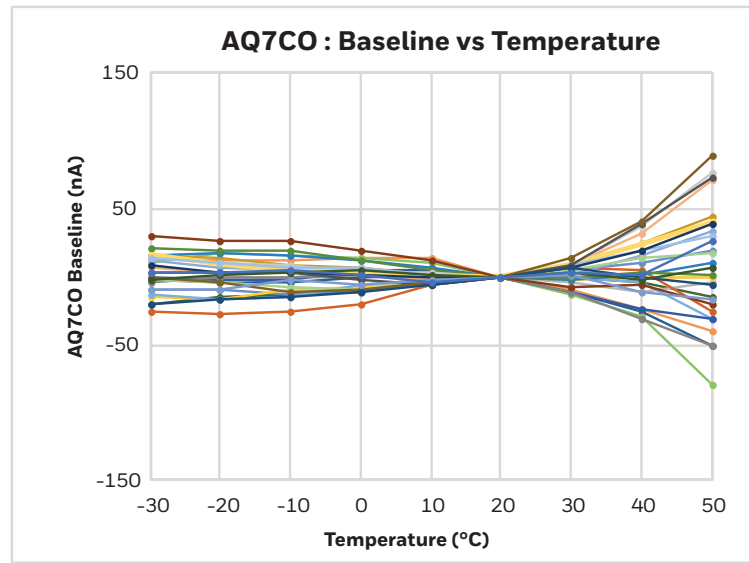

Table 1. Baseline vs. Temperature

Temperature (°C)	-30	-20	-10	0	10	20	30	40	50
Mean (nA)	1.82	0.78	0.57	0.73	0.81	0.00	0.93	4.07	7.32

Variation of Sensitivity with Temperature

The sensitivity of the AQ7CO sensor will vary as a function of temperature.

The data in Figure 6 shows the typical sensitivity performance across the operating temperature range and is presented normalized to the 20°C value with clean air.

The presented results reflect the typical performance of a production batch.

Figure 6. Sensitivity vs. Temperature

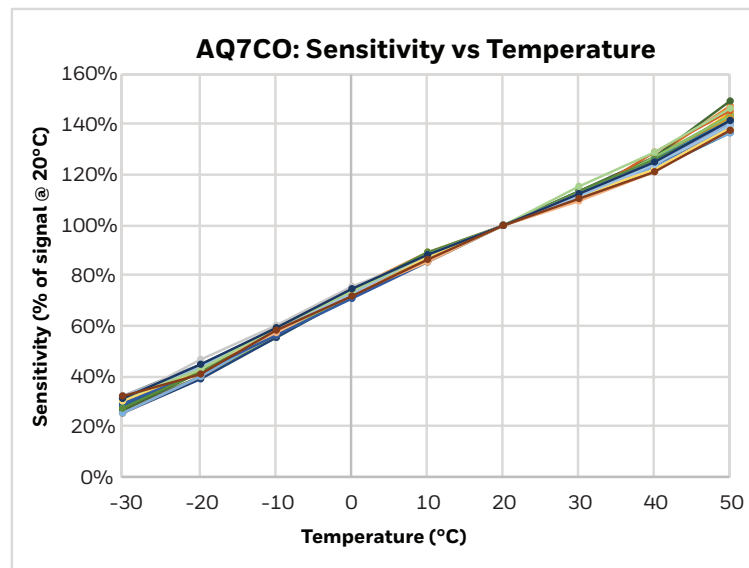

Table 2. Sensitivity vs. Temperature

Temperature (°C)	-30	-20	-10	0	10	20	30	40	50
Mean (%)	31.29	44.36	59.31	74.08	87.70	100.00	110.89	121.25	132.07

AQ7CO Carbon Monoxide (CO) Gas Characterization Note

Variation of T90 with Temperature

The T90 of the AQ7CO sensor will vary as a function of temperature. The data in Figure 7 shows the typical sensitivity performance across the operating temperature range.

Figure 7. T90 vs. Temperature

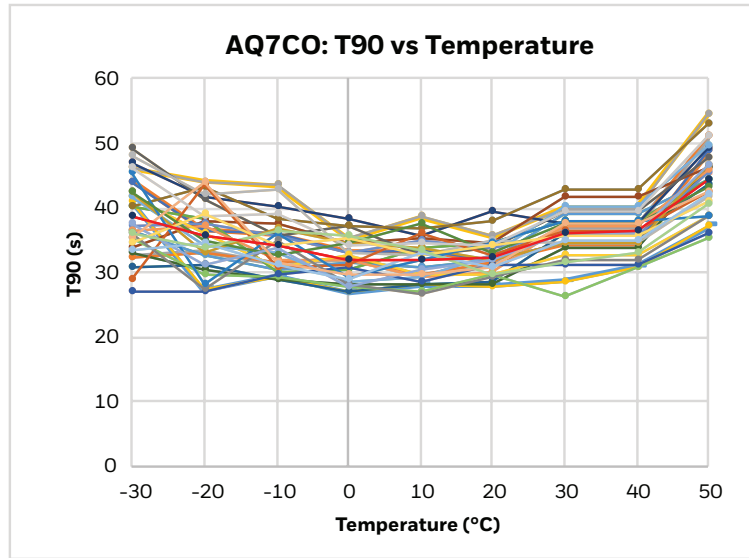

Table 3. T90 vs. Temperature

Temperature (°C)	-30	-20	-10	0	10	20	30	40	50
Mean(s)	38.67	35.67	34.02	31.96	32.04	32.36	36.00	36.28	44.37

AQ7CO Carbon Monoxide (CO) Gas Characterization Note

LONG-TERM CHARACTERISTICS

The sensor batches under test were stored in ambient conditions.

Long-Term Baseline Drift

The typical long-term baseline drift of the AQ7CO is represented in Figure 8, which reflects the performance of a typical production batch.

Figure 8. Long-Term Baseline Drift

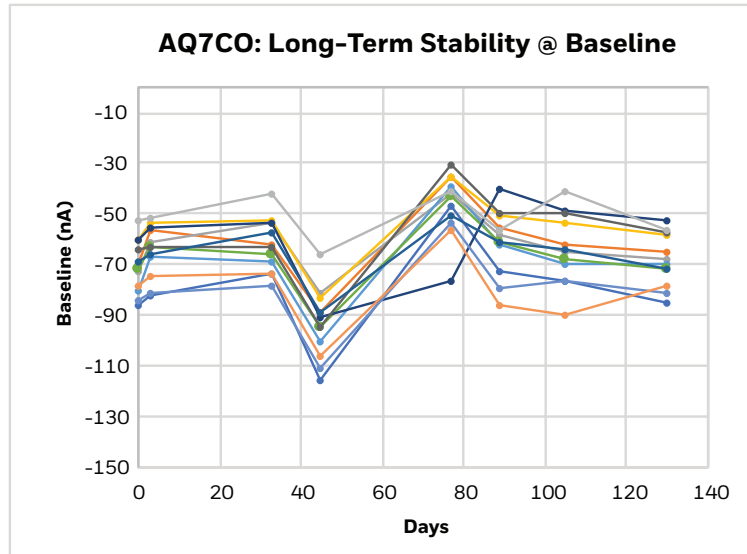

Long-Term Sensitivity Drift

The typical long-term sensitivity of the AQ7CO is represented in Figure 9, which reflects the performance of a typical production batch.

Figure 9. Long-Term Sensitivity Drift

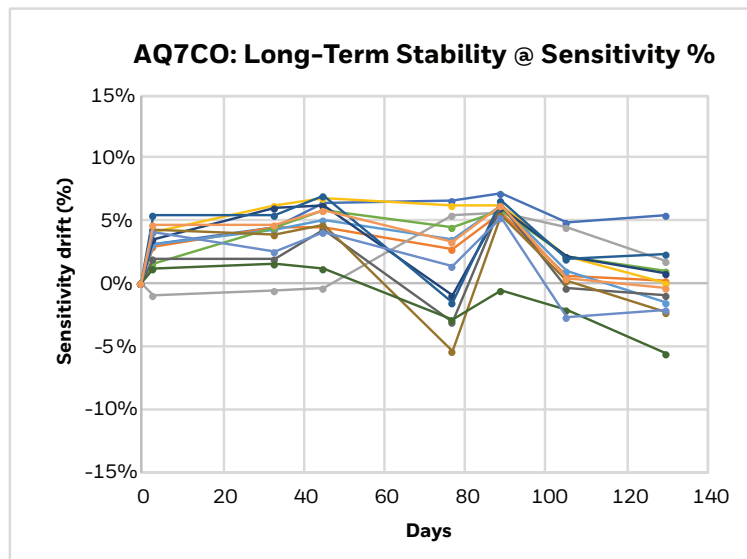

AQ7CO Carbon Monoxide (CO) Gas Characterization Note

Long-Term T90 Drift

The typical long term T90 of the AQ7CO is represented in Figure 10, which reflects the performance of a typical production batch.

Figure 10. Long-Term T90 Drift

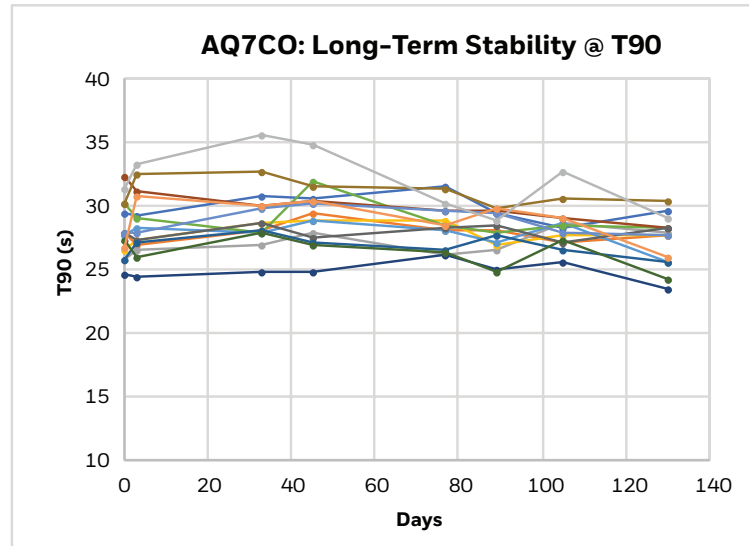

REPEATABILITY

The data in Figure 11 show the repeatability performance of the AQ7CO sensor when exposed repeatedly to CO. The presented results reflect the performance of a typical production batch.

Figure 11. Repeatability of AQ7CO Sensor Response to 1 ppm CO

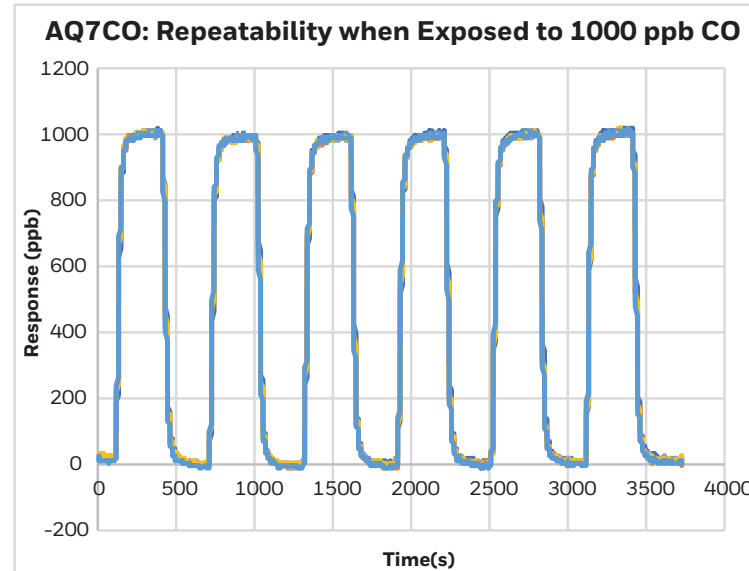

Table 4. Repeatability

Application	1st	2nd	3rd	4th	5th	6th
Mean response (ppb)	1002.54	992.21	992.34	994.25	1001.74	1007.38
Standard deviation (ppb)	6.19	5.41	6.02	6.19	6.75	8.59

AQ7CO Carbon Monoxide (CO) Gas Characterization Note

CALIBRATION GUIDELINES

Honeywell AQ7 provides a highly accurate and stable signal over time, which makes the series ideal for environmental applications including but not limited to air quality mini stations, portable systems, aerial vehicles, unmanned aerial vehicle, etc. The time interval between the initial calibration and subsequent calibrations depends on various factors, but is mainly attributed to environmental conditions at which the sensor is exposed (i.e. temperature and humidity). Strenuous applications may require a shorter recalibration period due to the challenging environmental conditions (extreme temperature and humidity ranges).

To calibrate the sensor, it is necessary to expose the AQ7 sensor to the target gas for a short period of time. The target gas cylinder can be balanced with either oxygen or nitrogen. Nevertheless, it's worth mentioning that electrochemical sensors require a few ppm oxygen to function, so it is not advised to expose the sensor to an oxygen depleted environment during long periods of time. In general, a five-minute period is sufficient to achieve a stable signal and span calibrate the sensor.

Please bear in mind that the whole calibration process should be performed at 20°C ±1°C. Table 5 describes the calibration process for AQ7 sensors.

Note: Before starting the calibration procedure, ensure that the sensor has been powered/connected to the relevant circuitry for 24 hours.

After exposing the sensor to clean air (typically a gas cylinder with a composition of 80% N₂ and 20% O₂), two parameters should be firstly measured corresponding to signal at the auxiliary electrode (AE₂₀) and working electrode (WE₂₀). Then, the sensor should be exposed to the target gas, where the span measurement should be taken. At this stage, the sensor's sensitivity can be calculated with the following formula:

Sensitivity at 20°C [nA/ppm] = $S_{20} = (\text{span measurement [nA]} - \text{baseline [nA]}) / \text{span value [ppm]}$ (Where baseline is the measurement in clean air.)

In step 4 (refer to Table 5), the sensor is exposed to clean air again, during this stage the sensor will recover from the target gas exposure, going back to its original baseline value.

For AQ7OZ and AQ7SO2 a few more additional steps are added to the calibration procedure (step 4 and 5), these steps will be required when the cross compensation has a large drift (Please refer to Compensation Algorithm section in this document for more information).

NOTE

Important Note: *Applicable only for AQ7OZ and AQ7SO2* The compensation factor "r3" is provided when the AQ7OZ sensor is acquired; in a similar fashion, "CF2" is provided with the AQ7SO2 sensor. Nevertheless, both compensation factors are prone to change over time and the variation rate of such variables will depend entirely in the environmental conditions and type of application at which the sensor is exposed to. It is highly recommended to follow steps 4 and 5 after the initial calibration.

NOTE

Safety Note: AQ7 gas sensors are designed to be used in ambient air monitoring. To ensure that the sensor and/or instrument in which it is used is operating properly, it is a requirement that the function of the device is confirmed by exposure to target gas (bump check) before each use of the sensor and/or instrument. Failure to carry out such tests may jeopardize the safety of people and property.

AQ7CO Carbon Monoxide (CO) Gas Characterization Note

Table 5. AQ7 Series Calibration Procedure

Sensor	Warm-up Time	Calibration Gas Concentration	Gas Path Saturation	EOL Step
AQ7CO	24 hours	1 ppm CO	1 ppm CO, 500 mL/min for 10 minutes	Step 1. Ambient air for 1 minute Step 2. Clean air* for 3 minutes to obtain WE ₂₀ and AE ₂₀ Step 3. 1 ppm CO for 3 minutes to obtain S ₂₀ Step 4. Clean air* for 2 minutes
AQ7ND	24 hours	400 ppb NO ₂	5 ppm NO ₂ , 500 mL/min for 30 minutes	Step 1. Ambient air for 1 minute Step 2. Clean air* for 10 minutes to obtain WE ₂₀ and AE ₂₀ Step 3. 400 ppb NO ₂ for 5 minutes to obtain S ₂₀ Step 4. Clean air* for 5 minutes
AQ7OZ	24 hours	400 ppb O ₃ 400 ppb NO ₂	2 ppm O ₃ , 500 mL/min for 40 minutes	Step 1. Ambient air for 1 minute Step 2. Clean air* for 10 minutes to obtain WE ₂₀ and AE ₂₀ Step 3. 400 ppb O ₃ for 10 minutes to obtain S ₂₀ Step 4. Clean air* for 3 minutes Step 5. 400 ppb NO ₂ for 5 minutes to obtain r3 Step 6. Clean air* for 3 minutes
AQ7SO2	24 hours	400 ppb SO ₂ 400 ppb O ₃	5 ppm SO ₂ , 350 mL/min for 20 minutes 2 ppm O ₃ , 2000 mL/min for 40 minutes	Step 1. Ambient air for 2 minutes Step 2. Clean air* for 30 minutes to obtain WE ₂₀ Step 3. 400 ppb SO ₂ for 2 minutes to obtain S ₂₀ Step 4. Clean air* for 2 minutes Step 5. 400 ppb O ₃ for 3 minutes to obtain CF2 Step 6. Clean air* for 1 minutes

* Clean air: Typically, a gas cylinder with a composition of 80 % N₂ and 20 % O₂

AQ7CO Carbon Monoxide (CO) Gas Characterization Note

RECOMMENDED GAS FLOW RATES

A suitable flow rate is required to ensure accurate calibration – it also means that the response from an AQ7 gas sensors is equivalent in configurations where gas is flowing over the sensor and those where the sample is allowed to diffuse into the sensor. The flowrate range is stated in the following table. Please note that the specified flow rates account for a single sensor.

Table 6. Recommended Flow Rate

Gas	Sensor Type	Flow Rate (ml/min)
Carbon Monoxide, CO	AQ7CO	300-1000
Nitrogen Dioxide, NO ₂	AQ7ND	300-1000
Ozone, O ₃	AQ7OZ	300-1000
Sulfur Dioxide, SO ₂	AQ7SO2	300-1000

Figure 12. Calibration Schematic

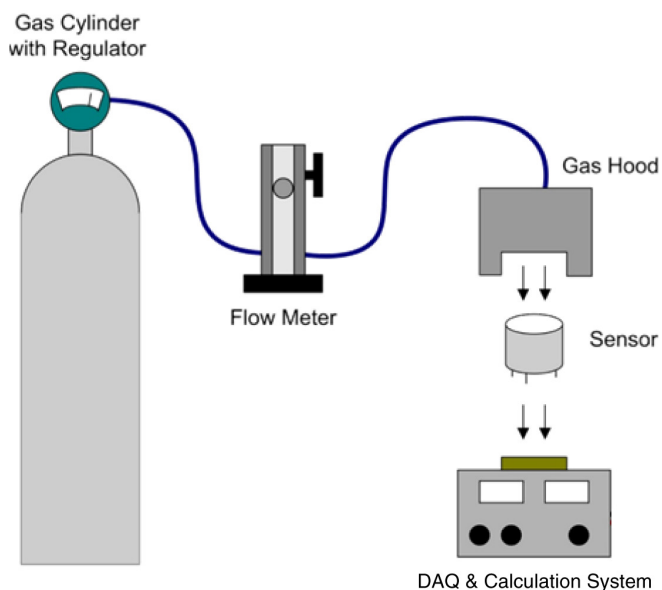

* Gas hood is not included in AQ7 product

AQ7CO Carbon Monoxide (CO) Gas Characterization Note

COMPENSATION ALGORITHM OF AQ7 SERIES SENSORS

AQ7 Series sensors (AQ7CO, AQ7ND, AQ7OZ and AQ7SO2) are specially designed to achieve high precision and high accuracy gas measurements, which makes them an ideal solution for monitoring extremely low gas concentrations in ambient air applications.

The response of an electrochemical sensor greatly depends on the environmental conditions to which the sensor has been exposed, this includes relative humidity and temperature changes. The constant environmental variation affects the sensor in many ways, in the short term it affects the sensor's sensitivity, baseline offset, etc. In the long term, the sensitivity of the sensor can be impacted by electrolyte concentration and other effects.

In order to provide a sensor that reliably gives an accurate reading under different conditions, we have developed a series of algorithms that compensate for these effects. By using these formulas, the user will be able to enhance the precision of these sensors in field applications, obtaining highly accurate gas readings in the range of parts per billion.

The following section will focus on the usage of the formulas/algorithms.

Table 7 enlists a comprehensive list of some of the sensor parameters and corresponding description of the terms used in the AQ7 Series:

Table 7. Parameter Description

WE	real-time signal of sensing electrode, nA
WE _T	signal of sensing electrode at specific temperature in highly pure and dry air, nA
WE ₂₀	signal of sensing electrode at 20°C in highly pure and dry air, nA
AE	real-time signal of auxiliary electrode, nA
AE _T	signal of sensing auxiliary at specific temperature in highly pure and dry air, nA
AE ₂₀	signal of auxiliary electrode at 20°C in highly pure and dry air, nA
S _T	sensitivity of sensing electrode at specific temperature, nA/ppm
S ₂₀	sensitivity of sensing electrode at 20°C, nA/ppm
r ₀	a function of temperature, usually $r_0 = a_0 * T^2 + b_0 * T + c_0$, T/°C
r ₁	a function of temperature, usually $r_1 = a_1 * T^2 + b_1 * T + c_1$, T/°C
r ₂	a function of temperature, usually $r_2 = a_2 * T^3 + b_2 * T^2 + c_2 * T + d_2$, T/°C
r ₃	compensation constant
CF ₁	NO ₂ gas cross-factor on AQ7SO2 sensor
CF ₂	O ₃ gas cross-factor on AQ7SO2 sensor
R _{NO2}	AQ7ND concentration reading (ppm)
R _{O3}	AQ7OZ concentration reading (ppm)

Table 6 provides a further comprehensive explanation of important compensation factors to get you a better insight of how the sensor is being compensated.

Other parameters can be obtained during the calibration procedure (including WE₂₀, AE₂₀ and S₂₀) – for more information, please consult section the calibration guidelines above.

AQ7CO Carbon Monoxide (CO) Gas Characterization Note

Table 8. Parameter Description

Sensor Type	Compensation Formula
$r_1 = WE_T - WE_{20}$	compensates for the zero-background current change due to temperature variation
$r_2 = S_T / S_{20}$	compensates sensing electrode sensitivity drift due to temperature variation
$r_3 = (WE - WE_T) / (AE - AE_T)$	<p>r3 compensates for NO₂ cross for AQ7OZ, it will be provided when you first get the AQ7OZ sensor, but since it will change after a period of time, then it will require additional regular NO₂ calibration. Please note that calibration period depends on the environmental conditions and gas concentrations of the application.</p> <p>Obtaining r3: Apply 400 ppb NO₂ to AQ7OZ, get the WE and AE after response signal is stabilized (normally 3-5 mins), please refer to calibration guidelines (AQ7OZ section, Step 4, 5 and 6) for additional details</p>
$r_0 = AE_T - AE_{20}$	compensates for the zero-background current change due to temperature variation for auxiliary electrode
CF1	NO ₂ cross sensitivity on AQ7SO2 divided by AQ7SO2's S _T
CF2	O ₃ cross sensitivity on AQ7SO2 divided by AQ7SO2's S _T

Table 9 below lists the compensation algorithm for the different sensor types. The resulting measurement will provide the target gas concentration reading in ppb.

Table 9. AQ7 Compensation Algorithm

Sensor Type	Compensation Formula
AQ7CO	Concentration (ppb) = $(WE - WE_{20} - r_1) / (r_2 * S_{20}) * 1000$
AQ7ND	Concentration (ppb) = $[(WE - AE) - (WE_{20} - AE_{20})] / (r_2 * S_{20}) * 1000$
AQ7OZ	Concentration (ppb) = $[WE - WE_{20} - r_1 - r_3 * (AE - AE_{20} - r_0)] / (r_2 * S_{20}) * 1000$
AQ7SO2	Concentration (ppb) = $(WE - WE_{20} - r_1 - CF_1 * R_{NO2} * r_2 * S_{20} - CF_2 * R_{O3} * r_2 * S_{20}) / (r_2 * S_{20}) * 1000$

APPENDIX 1 COMPENSATION PARAMETER TABLE

COMPENSATION PARAMETER TABLE TEMPLATE

AQ7 Series requires some parameters in their compensation formulas; these parameters are provided for each sensor. Table 10 shows how the sensor parameter information is presented.

Notes:

- When sensors are purchased, the sensor’s parameter table will be included in the sensor package.
- To achieve fully compensated high precision and high accuracy gas measurements in AQ7 sensors it is necessary to implement the compensation formulas (see Table 10).

Table 10. AQ7 Sensor Compensation Parameter Table

Sensor Type	Temp. Range	a ₁	b ₁	c ₁	a ₂	b ₂	c ₂	d ₂	a ₀	b ₀	c ₀	r ₃	CF ₁	CF ₂
AQ7CO	-30°C ≤T ≤50°C	-0.0135	-1.4038	32.488	0	-0.00002	0.0127	0.7494	N/A	N/A	N/A	N/A	N/A	N/A
AQ7ND	-30°C ≤T ≤50°C	0	0	0	0.000003	-0.0002	0.009	0.8831	N/A	N/A	N/A	N/A	N/A	N/A
AQ7OZ	-30°C ≤T ≤20°C	0	0	0	0	-0.0001	0.009	0.8631	0	0	0	▲	N/A	N/A
	20°C ≤T ≤50°C	-0.0594	2.0711	-17.962					-0.0651	2.4638	-23.417			
AQ7SO2	-30°C ≤T ≤20°C	0	0	0	0	-0.00004	0.0025	0.9617	N/A	N/A	N/A	N/A	-1.2	-0.65
	20°C ≤T ≤50°C	▲	▲	▲										

- Compensation parameters for AQ7CO and AQ7ND are the same for every sensor.

▲ This parameter will have a different value for each sensor (applicable for AQ7OZ and AQ7SO2)

APPENDIX 2

RECOMMENDED CIRCUIT

RECOMMENDED CIRCUIT

The recommended circuit for un-biased 4-electrode AQ7 Series gas sensors is shown below. The description below can be applied to all AQ7 Sensors. The signal processing circuit is essentially divided into two parts.

The first part is a potentiostat circuit designed to keep the sensor voltage constant between the sensing and reference electrodes. An op amp is used to compare the voltage at the reference pin to a stable bias voltage. Any movement of the reference pin voltage is compensated for by adjusting voltage on the counter pin. The circuit should draw no current from the sensor reference pin or the sensor output will be unstable. Further, the offset voltage of this op amp needs to be very low (typically 60 μV to 100 μV) or be nulled out, as offset in the circuit will appear as baseline offset in the sensor / instrument.

The second part of the circuit, applied to both sensing and auxiliary pins, is a transimpedance amplifier (TIA). The job of this circuit is to amplify the small current generated at the sensing pin when gas is detected and convert to a much larger voltage output which can be easily measured by instrumentation. Input is via a small load resistor (R106, R121 in the example circuit), whose value is specified on the sensor datasheet.

Gain of this circuit is controlled by the feedback resistor, which is typically from 20k to 1M (R108, R115, R123 and R132 in the example). The two op amps following the sensing and auxiliary electrodes are arranged as a transimpedance and buffer amplifier correspondingly. The circuit gain should be high enough to give a readable output, but not so high as to saturate the op amp at its highest (overload) output.

The signal processing circuit is based on operation from a single rail 5 V op-amp circuit with rail-to-rail output and a virtual ground reference for the sensor of 2.5 V. The first circuit in the power and potential section is used for this purpose. The second circuit in this section comes from a regulator that is used to provide an analogue voltage supply (marked as V_A)

Please note that there is a different configuration for the CO & SO₂ and the O₃ & NO₂ driving circuits (Figures 13 and 15). The first one has a positive going signal from the sensor, whereas the second one has a negative going signal; this is to standardise the sensor output regardless of the gas type - whether this is an oxidising (CO and SO₂) or reducing (O₃ and NO₂) gas. In short, both configurations are design to get a positive output from the sensor after the signal processing phase.

For CO and SO₂ circuitry, the sensing and auxiliary signal with no target gas presented will be around 1.48 V; whereas for NO₂ and O₃ circuitry, the sensing and auxiliary signal with no target gas presented will be around will be around 1.45 V.

The output from the circuit will be positive with respect to virtual ground for sensors measuring CO and SO₂, while the output voltage for sensing / Auxiliary signal output ranges from 1.48 V \pm 0.03 V to 4.5 V. Output will be also positive with respect to virtual ground for sensors measuring NO₂ and O₃, while the output signal voltage ranges from 1.45 V \pm 0.03 V to 4.5 V.

APPENDIX 2 RECOMMENDED CIRCUIT AQ7CO & AQ7SO2

Figure 13. Signal Processing AQ7CO & AQ7SO2

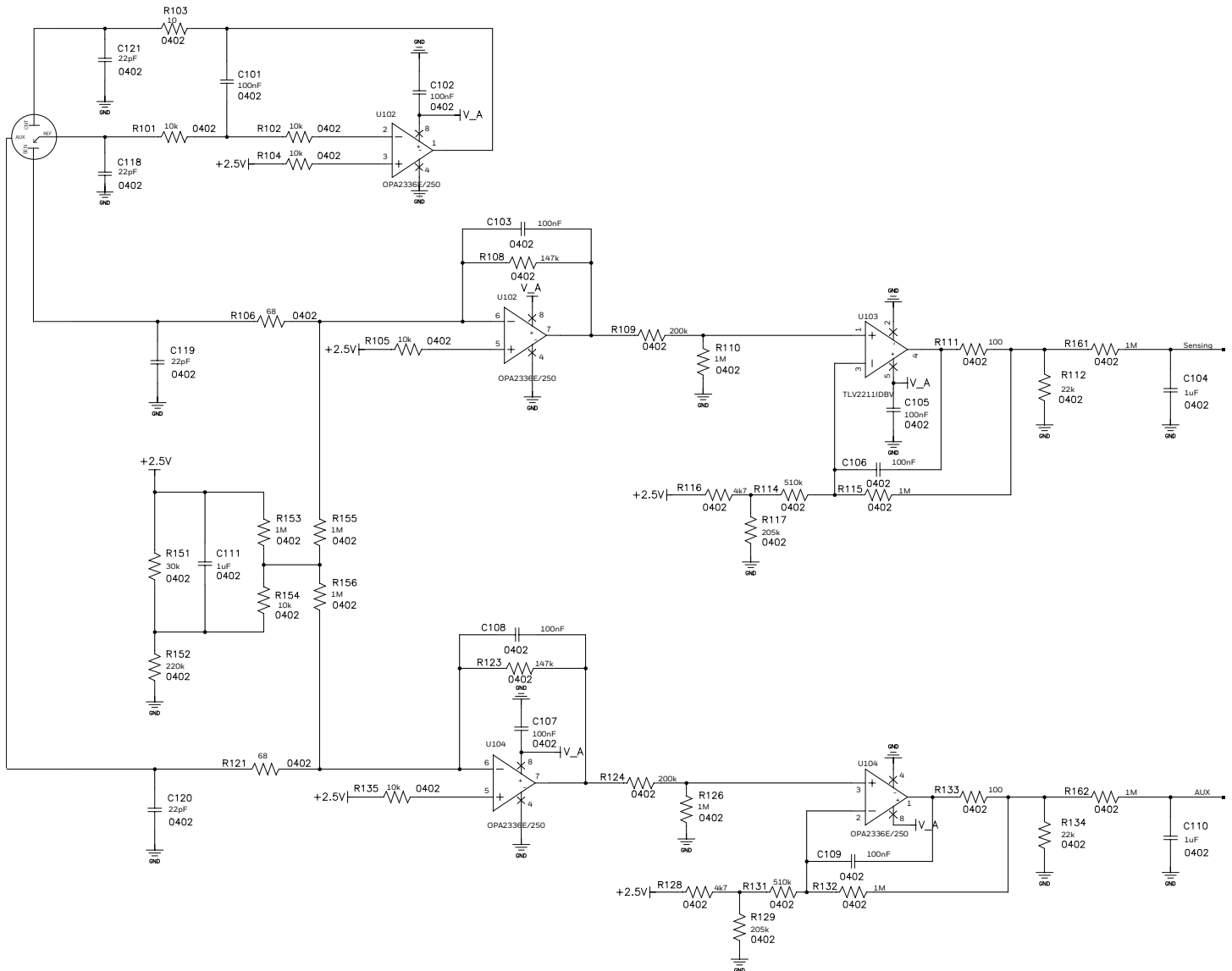

U101 – REF3425IDBVR (low-drift and low-power) circuit is to provide an accurate and stable reference voltage (2.5 V) to serve as virtual ground.

U100 – This low dropout (LP5907 or similar, with low noise and low-power) is to provide a stable voltage for the circuit. Please refer to chosen LDO datasheet for more detail.

Recommended op amps – the op amp amplifier should have either a low offset (<100 μ V typical) or have its offset nulled out. This amplifier should also have a low power consumption. A suitable op amp is the OPA2336E, TLV2211 IDBV or similar. This amplifier is used both as potentiostat and a current to voltage converter (trans-impedance amplifier)

AQ7CO Carbon Monoxide (CO) Gas Characterization Note

Figure 14. Power and Potential AQ7CO & AQ7S02

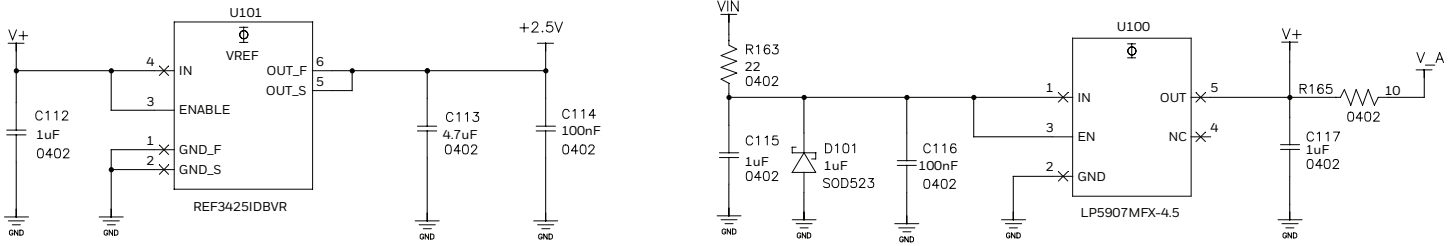

NOTE

Other op amp configurations may be used, including single- and dual-supply rails. In this case the reference voltage (bias voltage) will need to change to suit the circuit output range and sensor output, avoiding saturation of the op amp at limits of operation and ensuring a stable bias/virtual ground reference voltage.

APPENDIX 2 RECOMMENDED CIRCUIT AQ7OZ & AQ7ND

Figure 15. Signal Processing AQ7OZ & AQ7ND

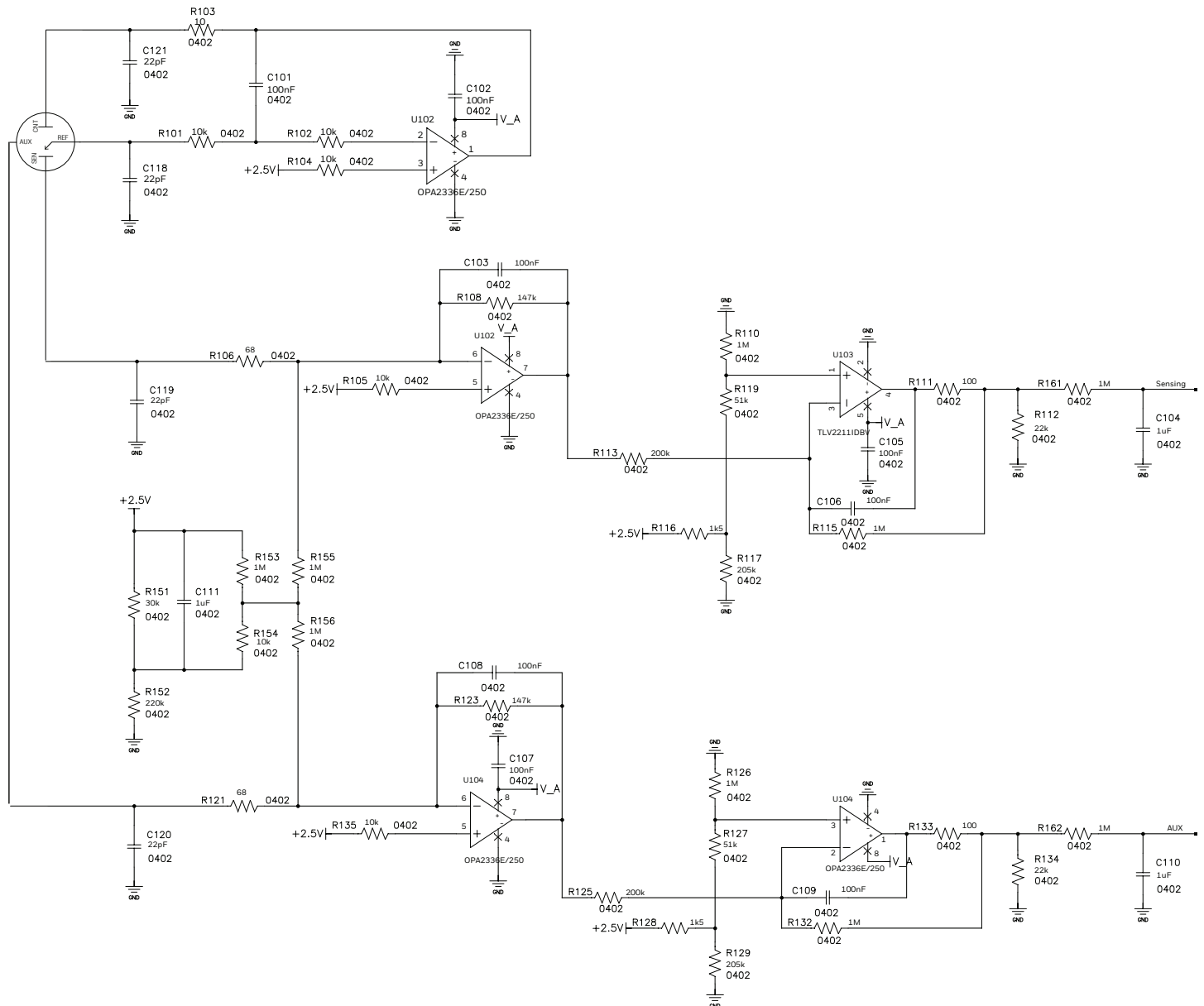

- U101** – REF3425IDBVR (low-drift and low-power) circuit is to provide an accurate and stable reference voltage (2.5 V) to serve as virtual ground.
- U100** – This low dropout (LP5907 or similar, with low noise and low-power) is to provide a stable voltage for the circuit. Please refer to chosen LDO datasheet for more detail.
- Recommended op amps** – the op amp amplifier should have either a low offset (<100 μ V typical) or have its offset nulled out. This amplifier should also have a low power consumption. A suitable op amp is the OPA2336E, TLV2211 IDBV or similar. This amplifier is used both as potentiostat and a current to voltage converter (trans-impedance amplifier)

AQ7CO Carbon Monoxide (CO) Gas Characterization Note

Figure 16. Power and Potential AQ7OZ & AQ7ND

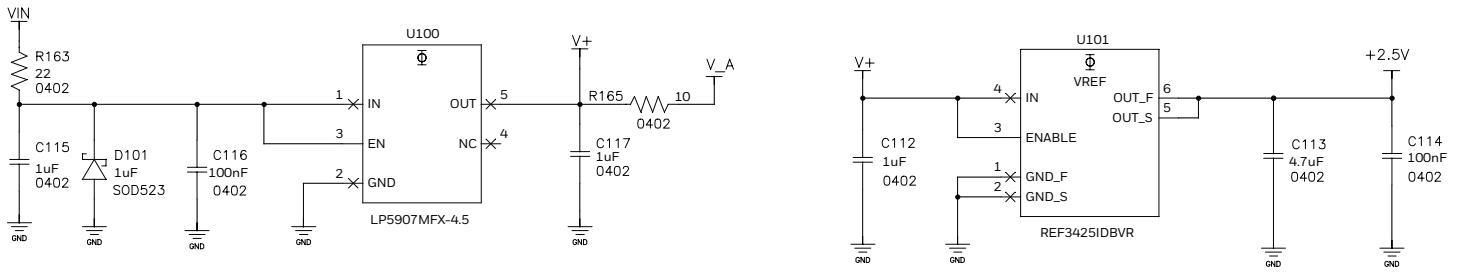

NOTE

Other op amp configurations may be used, including single- and dual-supply rails. In this case the reference voltage (bias voltage) will need to change to suit the circuit output range and sensor output, avoiding saturation of the op amp at limits of operation and ensuring a stable bias/virtual ground reference voltage.

WARRANTY/REMEDY

Honeywell warrants goods of its manufacture as being free of defective materials and faulty workmanship during the applicable warranty period. Honeywell's standard product warranty applies unless agreed to otherwise by Honeywell in writing; please refer to your order acknowledgment or consult your local sales office for specific warranty details. If warranted goods are returned to Honeywell during the period of coverage, Honeywell will repair or replace, at its option, without charge those items that Honeywell, in its sole discretion, finds defective. **The foregoing is buyer's sole remedy and is in lieu of all other warranties, expressed or implied, including those of merchantability and fitness for a particular purpose. In no event shall Honeywell be liable for consequential, special, or indirect damages.**

While Honeywell may provide application assistance personally, through our literature and the Honeywell web site, it is buyer's sole responsibility to determine the suitability of the product in the application.

Specifications may change without notice. The information we supply is believed to be accurate and reliable as of this writing. However, Honeywell assumes no responsibility for its use.

⚠️ WARNING MISUSE OF DOCUMENTATION

- The information presented in this characterization note is for reference only. Do not use this document as a product installation guide.
- Complete installation, operation, and maintenance information is provided in the instructions supplied with each product.

Failure to comply with these instructions could result in death or serious injury.

FOR MORE INFORMATION

Honeywell Sensing and Safety Technologies services its customers through a worldwide network of sales offices and distributors. For application assistance, current specifications, pricing or the nearest Authorized Distributor, visit [our website](#) or call:

USA/Canada	+1 302 613 4491
Latin America	+1 305 805 8188
Europe	+44 1344 238258
Japan	+81 (0) 3-6730-7152
Singapore	+65 6355 2828
Greater China	+86 4006396841

Honeywell Sensing and Safety Technologies

830 East Arapaho Road
Richardson, TX 75081
sps.honeywell.com/ast