

# Digital Pressure Sensor with CANopen<sup>®</sup>, Model DPS



## **PERSONAL INJURY WARNING**

**DO NOT USE** these products as safety or emergency stop devices or in any other application where failure of the product could result in personal injury.

**Failure to comply with these instructions could result in death or serious injury.**

## **IMPORTANT**

It is recommended that you read this document thoroughly before applying power to this unit.

### **Table of Contents**

|  |    |
|--|----|
| Chapter 1 - General Information                    | 1  |
| Chapter 2 - Technical Data and Performance Details | 3  |
| Chapter 3 - Introduction                           | 6  |
| Chapter 4 - Setting Up                             | 7  |
| Chapter 5 - Network Management                     | 11 |
| Chapter 6 - Heartbeat Protocol                     | 13 |
| Chapter 7 - Process Data Objects                   | 13 |
| Chapter 8 - Service Data Objects                   | 14 |
| Chapter 9 - Emergency Objects                      | 15 |
| Chapter 10 - Operation                             | 15 |
| Appendix   | 20 |

### **RELEASE INFORMATION**

| Document Name  | Doc. ID  | Release No. | Pub. Date  |
|--|----------|-------------|------------|
| Digital Pressure Sensor with CANopen <sup>®</sup> , Model DPS, User/Technical Manual | 50085804 | A           | May 2013   |
| Digital Pressure Sensor with CANopen <sup>®</sup> , Model DPS, User/Technical Manual | 50085804 | B           | April 2016 |









### **REFERENCES**

The following list identifies all documents that may be sources of reference for materials discussed in this publication.

- Digital Pressure Sensor with CANopen<sup>®</sup>, Model DPS, product sheet

The following table lists those symbols used in this document to denote certain conditions.

**Table 1 – Table Symbol Definitions**

| Symbol  | Definition   |
|---|--|
|    | <b>ATTENTION:</b> Identifies information that requires special consideration.  |
|    | <b>TIP:</b> Identifies advice or hints for the user, often in terms of performing a task.  |
|    | <b>REFERENCE - EXTERNAL:</b> Identifies an additional source of information outside of the bookset.  |
|    | <b>REFERENCE - INTERNAL:</b> Identifies an additional source of information within the bookset.  |
| <b>CAUTION</b>  | <b>CAUTION:</b> Indicates a situation which, if not avoided, may result in equipment or work (data) on the system being damaged or lost, or may result in the inability to properly operate the process. |
|    | <b>CAUTION:</b> Caution symbol indicates a potentially hazardous situation which, if not avoided, may result in minor or moderate injury. It may also be used to alert against unsafe practices.         |
|    | <b>CAUTION:</b> Caution symbol on the equipment refers the user to the product manual for additional information. The symbol appears next to required information in the manual.                         |
|   | <b>WARNING:</b> Warning symbol indicates a potentially hazardous situation, which, if not avoided, could result in serious injury or death.  |
|  | <b>WARNING:</b> Warning symbol on the equipment refers the user to the product manual for additional information. The symbol appears next to required information in the manual.                         |

## CHAPTER 1 - GENERAL INFORMATION

### 1.1 Introduction

Honeywell's Digital Pressure Sensor with CANopen<sup>®</sup>, Model DPS, is an addition to Honeywell's general-purpose pressure sensors that are pre-configured with a variety of features and options for use in a wide range of demanding applications. Model DPS pressure sensors are a rugged, stainless steel, all-welded devices designed to work with a variety of media, and built to provide consistent performance in harsh environments. CANopen<sup>®</sup> protocol allows customers to:

- Connect to longer distance without losing the accuracy
- Reduce the wires to be connected
- Take advantage of robust and superior error handling capability
- Access calibration
- Easily track each device in the network with their unique serial numbers
- Update rate of each device connected in the network which can be set at different rates

Configurations for digital measurements are fully temperature compensated and calibrated for pressure ranges from 10 psi to 10K psi or 1 bar to 700 bar or 70 kPa to 70000 kPa.

Customers can choose from two different accuracies to meet their specific application requirements:

- $\leq 30$  psi,  $\pm 0.25$  %FS
- $> 30$  psi,  $\pm 0.1$  %FS or  $\pm 0.25$  %FS

### 1.2 Acronyms and Definitions

| Acronym | Definition                        |
|---------|-----------------------------------|
| ADC     | Analog to Digital Converter       |
| BFSL    | Best Fit Straight Line            |
| CAN     | Control Area Network              |
| CiA     | CAN in Automation                 |
| COB-ID  | Communication Object - Identifier |
| CS      | Command Specifier                 |
| DLC     | Data Length Code                  |
| EMCY    | Emergency                         |
| FS      | Full Scale                        |
| g       | Weight in gram                    |
| hex     | Hexadecimal                       |
| Hz      | Hertz                             |
| IP65    | Ingress Protection Rating         |
| kbps    | Kilo bit per second               |
| LSB     | Least Significant Bit             |
| LSS     | Layer Setting Services            |
| MIL-STD | Military Standard                 |
| mS      | millisecond                       |
| NMT     | Network Management                |
| NPT     | Non Plated Through                |
| oz      | Ounce                             |
| PDO     | Process Data Object               |
| PSI     | Pound-force per square inch       |
| RD      | Read access                       |
| SDO     | Service Data Object               |
| SYNC    | Synchronous                       |
| TPDO    | Transmission Process Data Object  |

## 1.3 Features and Benefits

(★ = Competitive Differentiator)

- Wide pressure range [from 10 psi to 10K psi or 1 bar to 700 bar or 70 kPa to 70000 kPa]: Provides support for many unique applications
- ★ Multiple pressure engineering units (psi, bar and kPa): Eliminates the customer having to make mathematical conversions, increasing flexibility and simplifying use
- Rugged design: All-welded, 300 series stainless steel and Hastelloy<sup>®</sup> design allow for use in a wide range of harsh environments
- Accuracy options [  $\leq 30$  psi,  $\pm 0.25$  %FS or  $>30$  psi,  $\pm 0.1$  %FS or  $\pm 0.25$  %FS]: Allow customers to select the accuracy level required for their application
- Output: CANbus with CANopen<sup>®</sup> protocol
- Total Error Band [ $\pm 2$  % FS]: Honeywell specifies Total Error Band (TEB), the most comprehensive, clear and meaningful measurement that includes nonlinearity, repeatability and hysteresis as well as temperature error
- Designed for configurability: A selection of pressure types, accuracy levels, pressure ranges, pressure connections and electrical terminations allows customers the ability to configure the devices to meet their specific application needs
- ★ Connectors: 5-pin M12, which can be used in industrial applications, and 6-pin Bendix, which can be used in transportation applications
- Mechanical shock 100 G/11 ms: Allows the device to withstand harsh environments
- IP65 rated: Provides protection when used in harsh environments
- CiA (CAN in Automation) certified

## 1.4 Potential Applications

- Transportation
  - Agricultural equipment
  - Automotive test benches
  - Construction equipment
  - Rail equipment testing
  - Train communication network
- Industrial
  - General industrial process control and factory automation/industrial equipment
- Medical
  - Blood dialysis equipment
  - Medical equipment systems (i.e., X-ray collimator, MRI scanning, etc.)
- Aerospace
  - Test and research labs

## CHAPTER 2 - TECHNICAL DATA AND PERFORMANCE DETAILS

### 2.1 Physical Dimensions

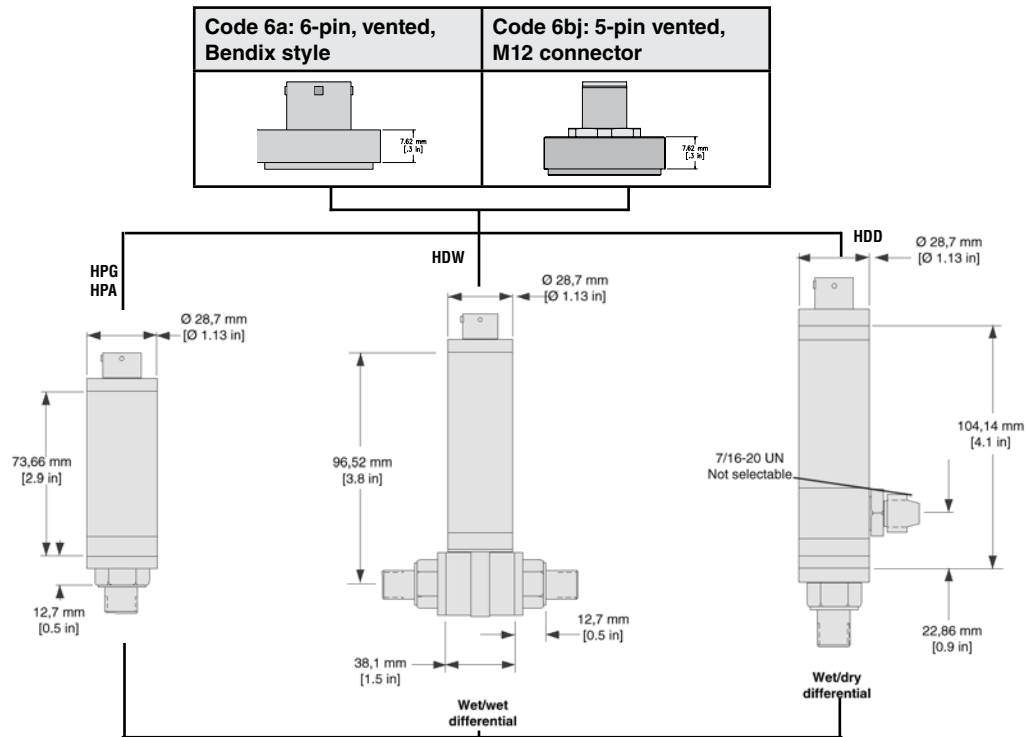

#### Pressure ports

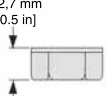
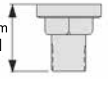
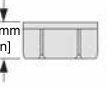
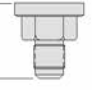
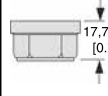
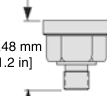
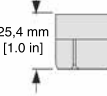
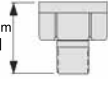
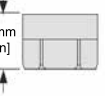
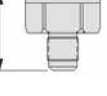
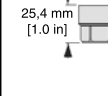
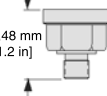
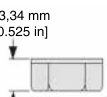
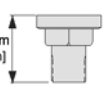
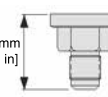
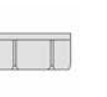
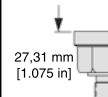
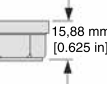
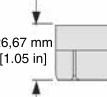
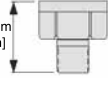
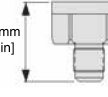
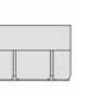
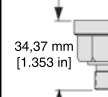
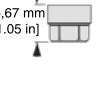
|                              | Code 5a<br>1/4-18 NPT female   | Code 5b<br>1/4-18 NPT male   | Code 5c<br>7/16-20 UNF female  | Code 5d<br>7/16-20 UNF male   | Code 5f<br>G 1/4 B female  | Code 5g<br>G 1/4 B male  |
|------------------------------|--|--|--|---|--|--|
| <b>Less than 1000 psi</b>    | 12,7 mm [0.5 in]<br>    | 28,0 mm [1.1 in]<br>    | 15,24 mm [0.6 in]<br>   | 25,4 mm [1.0 in]<br>   | 17,78 mm [0.7 in]<br>   | 30,48 mm [1.2 in]<br>   |
| <b>Greater than 1500 psi</b> | 25,4 mm [1.0 in]<br>    | 33,02 mm [1.3 in]<br>   | 25,4 mm [1.0 in]<br>    | 33,02 mm [1.3 in]<br>  | 25,4 mm [1.0 in]<br>    | 30,48 mm [1.2 in]<br>   |
|                              | Code 5h<br>1/8-27 NPT female   | Code 5i<br>1/8-27 NPT male   | Code 5p<br>M12-1.5 male  | Code 5q<br>M12-1.5 female   | Code 5r<br>9/16-18 SAE male  | Code 5s<br>9/16-18 SAE female  |
| <b>Less than 1000 psi</b>    | 13,34 mm [0.525 in]<br> | 22,99 mm [0.905 in]<br> | 26,04 mm [1.025 in]<br> | 12,7 mm [0.5 in]<br>   | 27,31 mm [1.075 in]<br> | 15,88 mm [0.625 in]<br> |
| <b>Greater than 1500 psi</b> | 26,67 mm [1.05 in]<br>  | 28,45 mm [1.12 in]<br>  | 33,53 mm [1.32 in]<br>  | 26,67 mm [1.05 in]<br> | 34,37 mm [1.353 in]<br> | 26,67 mm [1.05 in]<br>  |

## 2.2 Electrical Termination and Pin Assignment

Electrical connection can be selected from 6-pin Bendix connector or 5-pin M12 connector.

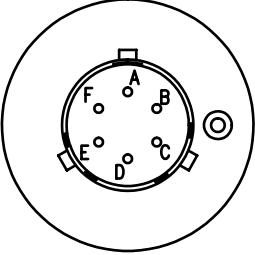
| 6-pin Bendix connector  | Pin | Assignment |
|---|-----|------------|
|  | A   | CAN_SHLD   |
|   | B   | CAN_V+     |
|   | C   | CAN_GND    |
|   | D   | CAN_H      |
|   | E   | CAN_L      |
|   | F   | NC         |

M12 electrical connector

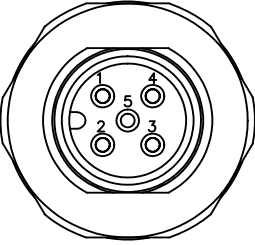
| 5-pin M12 connector  | Pin | Assignment |
|--|-----|------------|
|  | 1   | CAN_SHLD   |
|  | 2   | CAN_V+     |
|  | 3   | CAN_GND    |
|  | 4   | CAN_H      |
|  | 5   | CAN_L      |

## 2.3 Pressure Ports

See available pressure ports in physical dimension diagram included in Section 2.1.

## 2.4 Pressure Media Compatibility

Media that is compatible with stainless steel 316L and Hastelloy<sup>®</sup>.

## 2.5 Physical and Environmental Specifications

| Characteristic  | Parameter   |
|---|---|
| <b>Weight</b><br><i>(representative of HPG &amp; HPA)</i> | 100 psi: 234 g [8.25 oz]<br>(1/4-18 NPT port with Bendix)<br>100 psi: 236 g [8.32 oz]<br>(1/4-18 NPT port with M12) |
| <b>Shock</b>  | 100 g [11 ms] peak  |
| <b>Vibration</b>  | MIL-STD-810C, Figure 514.2-5, curve AK, Table 514.2-V, random vibration test [overall g rms = 20.7 min.]            |
| <b>Compensated temperature range</b>                      | 4 °C to 60 °C [40 °F to 140 °F]   |
| <b>Operating and storage temperature range</b>            | -25 °C to 85 °C [-13 °F to 185 °F]  |
| <b>Approvals</b>  | CiA (CAN In Automation), CE Marked, Declaration of Conformity on request  |

## 2.6 Mechanical Specifications

| Characteristic                              | Parameter   |
|---|---|
| <b>Media<sup>1</sup></b>                    | gas, liquid   |
| <b>Overload (safe), positive direction</b>  | 1000 psi and below: 4X full scale or 3000 psi, whichever is less<br>1500 psi and above: 4X full scale or 15000 psi, whichever is less |
| <b>Overload (safe), negative direction</b>  | 4X full scale or 250 psi, whichever is less   |
| <b>Overload (burst), positive direction</b> | 1000 psi and below: 3000 psi  |
| <b>Overload (burst), negative direction</b> | 1500 psi and above: 15000 psi   |
| <b>Pressure port</b>                        | 200% over capacity  |
| <b>Wetted parts material</b>                | Ha C276 & 316L stainless steel  |

### NOTES:

- The wet/wet differential pressure sensor has two separate, welded Hastelloy<sup>®</sup> diaphragms. In wet/dry unit, the wet port (high port) has all-welded stainless steel and Hastelloy<sup>®</sup> construction. The dry port (low port) has no isolation diaphragm.

## 2.7 Electrical Specifications

| Characteristic    | Parameter       |
|-------------------|-----------------|
| <b>Excitation</b> | 9 Vdc to 28 Vdc |

## 2.8 Recommended Grounding

If there is a provision to ground the enclosure at the application being used, use the recommended grounding method as shown in Figure 1.

**Figure 1. Recommended Shielding Diagram 1**

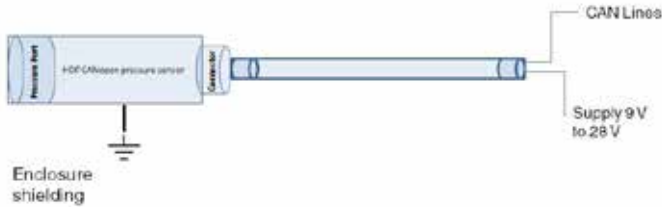

If there is no provision to ground the enclosure in the application, this shielding method is preferred for wires that run longer. The shielding of the cable can be connected to CAN\_SHLD of the connector (pin 1 of M12 or Pin A of Bendix) and it can be grounded at the far end (see Figure 2).

**Figure 2. Recommended Shielding Diagram 2**

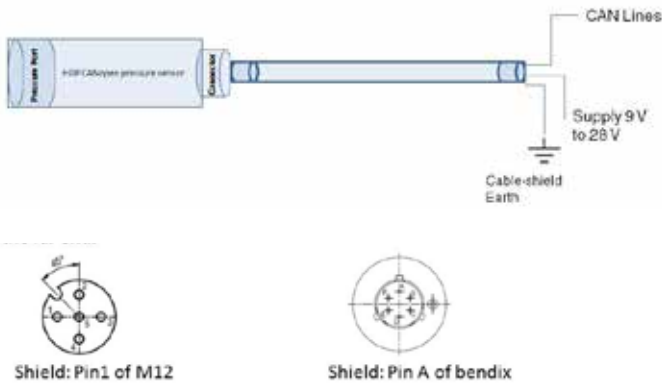

## 2.9 Performance Specifications

At 25 °C [77 °F] and a rated excitation unless otherwise noted

| Characteristic                       | Parameter  |
|--------------------------------------|--|
| <b>Accuracy<sup>2,3</sup></b>        | ≤30 psi: ±0.25 %FS<br>>30 psi: ±0.1 %FS, ±0.25 %FS |
| <b>ADC resolution</b>                | 12 bit   |
| <b>Total Error Band<sup>4</sup></b>  | ±2 %FS   |
| <b>User-configurable update rate</b> | 250 Hz (max.); 10 Hz (default)                     |
| <b>Baud rate</b>                     | 125 kbps (default)                                 |

### NOTES:

- Includes pressure non-linearity (BFSL), pressure hysteresis and non-repeatability. Thermal errors are not included.
- Differential sensors are calibrated in positive direction and accuracy specification is valid in positive direction only.
- Includes zero error, span error, thermal effect on zero, thermal effect on span, thermal hysteresis, pressure-non-linearity, pressure hysteresis and non-repeatability.

### ATTENTION

- The wet/wet differential pressure sensor has two separate, welded Hastelloy<sup>®</sup> diaphragms. In wet/dry unit, the wet port (high port) has all-welded stainless steel and Hastelloy<sup>®</sup> construction. The dry port (low port) has no isolation diaphragm.
- Includes pressure non-linearity (BFSL), pressure hysteresis, and non-repeatability. Thermal errors are not included.
- Differential sensors are calibrated in positive direction and accuracy specification is valid in positive direction only.
- Includes zero error, span error, thermal effect on zero, thermal effect on span, thermal hysteresis, pressure-non-linearity, pressure hysteresis, and non-repeatability.

## CHAPTER 3 - INTRODUCTION

The Digital Pressure Sensor with CANopen<sup>®</sup>, Model DPS, implements the standard CANopen<sup>®</sup> communications protocol. The CANopen<sup>®</sup> standards supported are shown in Table 1. These standards are available from CAN in Automation [www.can-cia.de](http://www.can-cia.de).

### 3.1 Supported Standards

**Table 1. Supported CANopen<sup>®</sup> Standards**

| CANopen <sup>®</sup> CiA Standard | Version | Description  |
|-----------------------------------|---------|--|
| <b>DS301</b>                      | 4.02    | Application layer and communication profile                  |
| <b>DR-303-2</b>                   | 1.1     | CANopen <sup>®</sup> representation of SI units and prefixes |
| <b>DSP 305</b>                    | 2.2     | CANopen <sup>®</sup> layer setting services and protocol     |
| <b>DSP 404</b>                    | 1.0     | Measuring devices and closed loop controllers                |

The Model DPS pressure sensor is provided with the CANopen<sup>®</sup> default settings as shown in Table 2.

**Table 2. CANopen<sup>®</sup> Default Settings**

| Parameter                      | Default Value (Hex) | Description   |
|--------------------------------|---------------------|---|
| <b>Node-ID</b>                 | 7F                  | The Node-Identifier used for CANopen <sup>®</sup> communications  |
| <b>COB-ID PDO</b>              | 180 + Node-ID       | The communications object identifier of the process data object   |
| <b>COB-ID SDO</b>              | 600 + Node-ID       | The communications object identifier of the service data object   |
| <b>COB-ID EMERGENCY</b>        | 80 + Node-ID        | The communications object identifier of the emergency object  |
| <b>COB-ID NMT</b>              | 00                  | The communications object identifier of the network management object   |
| <b>COB-ID SYNC</b>             | 80                  | The communications object identifier of the synchronization object  |
| <b>LSS Master</b>              | 7E5                 | The identifier of the layer settings service master (host)  |
| <b>LSS Slave</b>               | 7E4                 | The identifier of the layer settings service slave (Digital Pressure Sensor with CANopen <sup>®</sup> Series) |
| <b>BOOTUP HEARTBEAT COB-ID</b> | 700 + Node-ID       | The communications object identifier for the heartbeat object   |
| <b>Bit rate</b>                | 125 Kbps            | The bit rate that is used for CAN communications. [Bit rate is mentioned in decimal]                          |



## CHAPTER 4 - SETTING UP

### 4.1 Procedure to Get Started

In order to operate in the host network it is necessary to ensure:

1. The Node-ID of the Digital Pressure Sensor with CANopen®, Model DPS, is not the same as any other node on the CANbus network.
2. The bit rate of the Digital Pressure Sensor with CANopen®, Model DPS, matches that of the network to which it is being connected.

These parameters are configured using the layer settings services. These parameters are configured prior to connecting the Model DPS in the host network.

### 4.2 Node-ID Configuration

The Node-ID is used to provide unique communication object identifiers for each CANopen® device on the network. Configuring of the Node-ID can be performed:

1. Prior to connection using the switch mode global command called Point-to-Point Configuration.
2. On the target network using the switch mode selective command called Network Configuration.

Table 3 shows the process of performing point-to-point Node-ID Configuration. Table 4 shows the process of performing Node-ID Configuration on network.

**Table 3. Point to Point Node-ID Configuration**

| ID(hex) | DLC | Data(Hex)               | Comment                   | Direction w.r.t Digital Pressure Sensor with CANopen® |
|---------|-----|-------------------------|---------------------------|---|
| 000     | 2   | 80 7F                   | Preoperational node ID 7F | Receive   |
| 7E5     | 8   | 04 01 00 00 00 00 00 00 | Configuration state       | Receive   |
| 7E5     | 8   | 11 7E 00 00 00 00 00 00 | Set node ID 7E            | Receive   |
| 7E4     | 8   | 11 00 00 00 00 00 00 00 | Response ok               | Transmit  |
| 7E5     | 8   | 17 00 00 00 00 00 00 00 | Store configuration       | Receive   |
| 7E4     | 8   | 17 00 00 00 00 00 00 00 | Response ok               | Transmit  |
| 7E5     | 8   | 04 00 00 00 00 00 00 00 | Waiting state             | Receive   |
| 000     | 2   | 81 7F                   | Reset node ID -7F         | Receive   |
| 77E     | 1   | 00                      | Boot up message           | Transmit  |

**Table 4. Node-ID Configuration On Network**

| ID(hex) | DLC | Data(Hex)               | Comment   | Direction w.r.t Digital Pressure Sensor with CANopen® |
|---------|-----|-------------------------|---|---|
| 000     | 2   | 80 7E                   | Preoperational node ID 7E   | Receive   |
| 7E5     | 8   | 40 62 03 00 00 00 00 00 | Vendor ID   | Receive   |
| 7E5     | 8   | 41 50 31 44 00 00 00 00 | Product code  | Receive   |
| 7E5     | 8   | 42 00 00 01 00 00 00 00 | Revision no.  | Receive   |
| 7E5     | 8   | 43 xx xx xx xx 00 00 00 | Serial number, where xx xx xx xx is the serial number of the device given along with the Model DPS unit | Receive   |
| 7E4     | 8   | 44 00 00 00 00 00 00 00 | Response ok   | Transmit  |
| 7E5     | 8   | 11 7F 00 00 00 00 00 00 | Set node ID 7F  | Receive   |
| 7E4     | 8   | 11 00 00 00 00 00 00 00 | Response ok   | Transmit  |
| 7E5     | 8   | 17 00 00 00 00 00 00 00 | Store configuration   | Receive   |
| 7E4     | 8   | 17 00 00 00 00 00 00 00 | Response ok   | Transmit  |
| 7E5     | 8   | 04 00 00 00 00 00 00 00 | Waiting state   | Receive   |
| 000     | 2   | 81 7E                   | Reset node ID -7E   | Receive   |
| 77F     | 1   | 00                      | Boot up message   | Transmit  |

## 4.3 Bit Rate Configuration

Configuring of the Bit Rate can be performed:

1. Prior to connection using the switch mode global command called Point-to-Point configuration.
2. On the target network using the switch mode selective command called Network Configuration.

Table 5 shows the process of performing point-to-point Bit Rate configuration. Table 6 shows the process of performing Bit Rate configuration on network.

**Table 5. Point-to-Point Bit Rate Configuration**

| ID(hex) | DLC | Data(Hex)               | Comment                   | Direction w.r.t Digital Pressure Sensor with CANopen <sup>®</sup> |
|---------|-----|-------------------------|---------------------------|---|
| 000     | 2   | 80 7f                   | Preoperational node ID 7f | Receive   |
| 7E5     | 8   | 04 01 00 00 00 00 00 00 | Configuration state       | Receive   |
| 7E5     | 8   | 13 00 04 00 00 00 00 00 | Set bit rate 125 kbit 04  | Receive   |
| 7E4     | 8   | 13 00 00 00 00 00 00 00 | Response ok               | Transmit  |
| 7E5     | 8   | 17 00 00 00 00 00 00 00 | Store configuration       | Receive   |
| 7E4     | 8   | 17 00 00 00 00 00 00 00 | Response ok               | Transmit  |
| 7E5     | 8   | 04 00 00 00 00 00 00 00 | Waiting state             | Receive   |
| 000     | 2   | 01 00                   | Enter operational state   | Receive   |
| 1ff     | 4   | Pressure data           |                           | Transmit  |

**Table 6. Bit Rate Configuration on Network**

| ID(hex) | DLC | Data(Hex)               | Comment   | Direction w.r.t Digital Pressure Sensor with CANopen <sup>®</sup> |
|---------|-----|-------------------------|---|---|
| 000     | 2   | 80 7E                   | Preoperational node Id 7E   | Receive   |
| 7E5     | 8   | 40 62 03 00 00 00 00 00 | Vendor ID   | Receive   |
| 7E5     | 8   | 41 50 31 44 00 00 00 00 | Product code  | Receive   |
| 7E5     | 8   | 42 00 00 01 00 00 00 00 | Revision no.  | Receive   |
| 7E5     | 8   | 43 xx xx xx xx 00 00 00 | Serial number, where xx xx xx xx is the serial number of the device given along with the Model DPS unit | Receive   |
| 7E4     | 8   | 44 00 00 00 00 00 00 00 | Response ok   | Transmit  |
| 7E5     | 8   | 13 00 04 00 00 00 00 00 | Set bit rate 125 Kbit 04  | Receive   |
| 7E4     | 8   | 13 00 00 00 00 00 00 00 | Response ok   | Transmit  |
| 7E5     | 8   | 17 00 00 00 00 00 00 00 | Store configuration   | Receive   |
| 7E4     | 8   | 17 00 00 00 00 00 00 00 | Response ok   | Transmit  |
| 7E5     | 8   | 04 00 00 00 00 00 00 00 | Waiting state   | Receive   |
| 000     | 2   | 01 00                   | Enter operational state   | Receive   |
| 1ff     | 4   | Pressure data           |   | Transmit  |

The new bit rate is valid after a reset of the device. It is highly recommended to power off the CANopen<sup>®</sup> slave device first and change the bit rate of the master to the desired value (125 kbit/s in this example). Performing a NMT reset node command will lead to error frames on the CANbus, because the master still has the previous bit rate. The available bit rates are given in Table 7.

**Table 7. Available Bit Rates**

| Bit Rate  | Table Index |
|-----------|-------------|
| 1000 Kbit | 0           |
| 500 Kbit  | 2           |
| 250 Kbit  | 3           |
| 125 Kbit  | 4           |
| 100 Kbit  | 5           |
| 50 Kbit   | 6           |

## 4.4 Activate Bit Timing Command

Send the activate bit timing command, as shown in Table 8, to re-start with the selected bit rate, before storing the bit rate. The switch delay is an Intel format unsigned integer number that represents a time delay in mS, e.g. 3E816 = 1000 mS. This time delay is used for two periods on the Digital Pressure Sensor with CANopen<sup>®</sup>, Model DPS. First, the new bit timing will not be applied until the delay is expired; secondly, no messages shall be sent by the Model DPS pressure sensor until the delay has expired once more.

Start the heartbeat and let it run at 100 ms. Then, set the bit rate. The heartbeat still runs. Then activate the bit timing and set the activation time to 1 sec. Then after 2 sec, the heartbeats start up again at the new bit rate.

**Table 8. Activate Bit Timing**

| ID(hex) | DLC | Data(Hex)               | Comment  | Direction w.r.t Digital Pressure Sensor with CANopen <sup>®</sup> |
|---------|-----|-------------------------|--|---|
| 67f     | 8   | 22 17 10 00 64 00 00 00 | Enable heartbeat message – once every 100 millisec | Receive   |
| 5ff     | 8   | 60 17 10 00 00 00 00 00 | Response ok  | Transmit  |
| 7ff     | 1   | 7f                      | Heartbeat message every 100 millisec               | Transmit  |
| 000     | 2   | 80 7f                   | Enter pre-operational state                        | Receive   |
| 7E5     | 8   | 04 01 00 00 00 00 00 00 | Configuration state                                | Receive   |
| 7E5     | 8   | 13 00 04 00 00 00 00 00 | Set bit rate 125 Kbit 04                           | Receive   |
| 7E4     | 8   | 13 00 00 00 00 00 00 00 | Response ok  | Transmit  |
| 7E5     | 8   | 04 00 00 00 00 00 00 00 | Waiting state                                      | Receive   |
| 7ff     | 1   | 7f                      | Heartbeat message every 100 millisec               | Transmit  |
| 7ff     | 1   | 7f                      | Heartbeat message every 100 millisec               | Transmit  |
| 7E5     | 8   | 04 01 00 00 00 00 00 00 | Configuration state                                | Receive   |
| 7E5     | 8   | 15 E8 03 00 00 00 00 00 | Configuration state                                | Receive   |
| 7E5     | 8   | 04 00 00 00 00 00 00 00 | Waiting state                                      | Receive   |
| 7ff     | 1   | 7f                      | Heartbeat message after 2 secs                     | Transmit  |
| 7ff     | 1   | 7f                      | Heartbeat message every 100 millisec               | Transmit  |

## CHAPTER 5 - NETWORK MANAGEMENT

The Digital Pressure Sensor with CANopen<sup>®</sup>, Model DPS, is a CANopen<sup>®</sup> NMT slave. Figure 3 shows the state transition diagram and the communication objects supported by each state. The Model DPS pressure sensor supports minimum boot-up. Minimum boot-up devices enter the pre-operational state automatically after finishing the device initialization.

### 5.1 Network Transition Diagram

In order to operate in the host network it is necessary to ensure:

1. The Node-ID of the Digital Pressure Sensor with CANopen<sup>®</sup>, Model DPS, is not the same as any other node on the CANbus network.
2. The bit rate of the Digital Pressure Sensor with CANopen<sup>®</sup>, Model DPS, matches that of the network to which it is being connected.

These parameters are configured using the layer settings services. These parameters are configured prior to connecting the Digital Pressure Sensor with CANopen<sup>®</sup>, Model DPS, in the host network.

The letters (in brackets) show which communication object types are allowed inside the different states:

- a. NMT, b. LSS, c. SDO, d. Emergency, e. PDO, f. Boot-up, g. Synchronization

The state transitions and the NMT command specifiers (in brackets):

- 1: Start remote node (0x01)
- 2: Stop remote node (0x02)
- 3: Enter pre-operational state (0x80)
- 4: Reset node (0x81)
- 5: Reset communication (0x82)
- 6: Device initialization finished, enter pre-operational state automatically, send boot-up message

The NMT message has the following format:

| COB-ID | Byte0 | Byte1   |
|--------|-------|---------|
| 0x0000 | CS    | Node-Id |

Figure 3. NMT State Transition Diagram

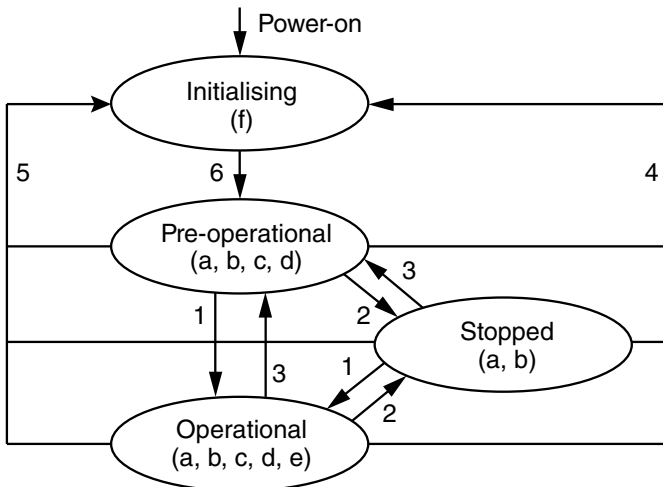

CS is the Command Specifier, which can have the following values:

| NMT Service                 | Command Specifier (hex) | Description  | Table 9: Start Remote Node            |            |                |
|-----------------------------|-------------------------|--|---------------------------------------|------------|----------------|
|                             |                         |  | ID(hex)                               | Byte 0 Cmd | Byte 1 Node-ID |
| Start remote node           | 1                       | The Digital Pressure Sensor with CANopen <sup>®</sup> , Model DPS, enters into operational state when Start remote node command is sent from the NMT master. In this state, the Digital Pressure Sensor with CANopen <sup>®</sup> starts giving out pressure data every 100 millisecond. | 00                                    | 1          | 7F             |
|                             |                         |  | Table 10: Stop Remote Node            |            |                |
| Stop remote node            | 2                       | The stop remote node command causes the Digital Pressure Sensor with CANopen <sup>®</sup> , Model DPS, to enter the stopped state. In the stopped state the NMT and LSS are available.   | 00                                    | 2          | 7F             |
|                             |                         |  | Table 11: Enter Pre-operational State |            |                |
| Enter pre-operational state | 80                      | The Digital Pressure Sensor with CANopen <sup>®</sup> , Model DPS, enters preoperational state after initialization. When the pre-operational state is entered, after initialization, a boot-up message is sent as shown in Table 12.  | 00                                    | 80         | 7F             |
|                             |                         |  | Table 12: Boot-up Message             |            |                |
|                             |                         |  | 700 + Node-ID                         |            | -              |
|                             |                         |  | 77F                                   | 00         | -              |
| Reset node                  | 81                      | The reset node command causes the Digital Pressure Sensor with CANopen <sup>®</sup> , Model DPS, to re-load the whole object dictionary from non-volatile memory. Table 13 shows the reset node command.   | Table 13: Reset Node                  |            |                |
|                             |                         |  | 00                                    | 81         | 7F             |
| Reset communication         | 82                      | The reset communications command causes the Digital Pressure Sensor with CANopen <sup>®</sup> , Model DPS, to re-load the communications area of the object dictionary from non-volatile memory. Table 14 shows the reset communication command.   | Table 14: Reset Command               |            |                |
|                             |                         |  | 00                                    | 82         | 7F             |

## CHAPTER 6 - HEARTBEAT PROTOCOL

The NMT master will use the heartbeat message produced by the Digital Pressure Sensor with CANopen<sup>®</sup>, Model DPS, to determine that the node is present on the network. The Model DPS will send a heartbeat message every n mS, where n is the heartbeat producer time available at object 0x1017. If the heartbeat producer time is zero then no heartbeat message will be transmitted. Table 15 depicts the Heartbeat message. The default heartbeat producer time for the Digital Pressure Sensor with CANopen<sup>®</sup>, Model DPS, is zero.

### 6.1 Heartbeat Message

**Table 15. Digital Pressure Sensor with CANopen<sup>®</sup> Heartbeat Message**

| COB-ID(hex)   | Byte 0 |
|---------------|--------|
| 0x700+Node-ID | State  |

Where state can have any of the following values

**Table 16. Heartbeat Protocol States**

| COB-ID(hex) | Byte 0          |
|-------------|-----------------|
| 0           | Boot-up         |
| 4           | Stopped         |
| 5           | Operational     |
| 7F          | Pre-operational |

## CHAPTER 7 - PROCESS DATA OBJECTS

The real-time process data transfer is performed by means of process data objects (PDO). Upon entering the operational state, the Digital Pressure Sensor with CANopen<sup>®</sup>, Model DPS, starts transmitting the pressure in 32 bit signed integer format at an update rate of 100 millisecs.

### 7.1 PDO Transmission Type

The transmission type parameter of a PDO specifies the transmission mode (synchronous, event driven) as well as the triggering mode.

#### Transmission modes:

- Synchronous
- Event-driven

#### Synchronous

For synchronous PDOs, the transmission type also specifies the transmission rate in the form of a factor based on the basic SYNC object transmission period. A transmission type of 0 means that the message shall be transmitted after occurrence of the SYNC (acyclic – not periodically), only if an event occurred before the SYNC. The transmission type 1 means that the message shall be transmitted with every SYNC object (cyclic). A transmission type of n means that the message shall be transmitted with every n-th SYNC object.

#### Event-driven

Event-driven TPDOs are transmitted without any relation to the SYNC object.

#### Triggering modes

In the Digital Pressure Sensors with CANopen<sup>®</sup>, Model DPS, two message-triggering modes are distinguished:

- Event-driven
- Synchronously triggered

#### Event- and timer-driven

Message transmission is either triggered by the occurrence of an application-specific event specified in manufacturer-specific profile or if a specified time (event-time) has elapsed without occurrence of an event.

#### Synchronously triggered

Message transmission is triggered by the occurrence of the SYNC object. The trigger condition is the number of sync and optionally an internal event. The Model DPS supports the transmission types listed in the Table 17.

**Table 17. Transmission Types Supported by the Digital Pressure Sensor with CANopen<sup>®</sup>, Model DPS**

| Transmission (hex) | Description   |
|--------------------|---|
| 0                  | Acyclic, synchronous transmission. The Digital Pressure Sensor with CANopen <sup>®</sup> , Model DPS, will transmit a PDO message after occurrence of the SYNC, but only if an event (change in the pressure data) occurred before the SYNC.  |
| 1-F0               | Cyclic, synchronous transmission. The Digital Pressure Sensor with CANopen <sup>®</sup> , Model DPS, will transmit the PDO message on reception of the nth SYNC message, where n is 1 to 240.   |
| FE                 | Asynchronous transmission. The Digital Pressure Sensor with CANopen <sup>®</sup> , Model DPS, will transmit the PDO message at the time interval defined by the event time (by default it transmits pressure data every 100 millisecond). The PDO is transmitted without any relation to the SYNC object. |
| FF                 | Asynchronous transmission. The Digital Pressure Sensor with CANopen <sup>®</sup> , Model DPS, will transmit the PDO message at the time interval defined by the event time (by default it transmits pressure data every 100 millisecond). The PDO is transmitted without any relation to the SYNC object. |

## 7.2 Changing the Output Units

The default unit of the process value is psi. The physical units of the process value can be read or modified by using the object 6131. When the units are changed using the object 6131, the units of all the objects associated with process value is changed internally by the Digital Pressure Sensor with CANopen<sup>®</sup>, Model DPS. Table 18 contains the list of the objects that are associated with process value. The Model DPS supports only 1 PDO.

**Table 18. List of Objects Affected by Unit Change**

| Object | Description                   |
|--------|-------------------------------|
| 6148   | AI span start                 |
| 6149   | AI span end                   |
| 6124   | AI input offset               |
| 6130   | AI input process value REAL32 |
| 2006   | Span                          |

**Table 19. Command to Change Physical Units from psi to Bar**

| ID(hex) | DLC | Data(Hex) |       |       |       |       |       |       |       | Description            | Direction w.r.t Digital Pressure Sensor with CANopen <sup>®</sup> |
|---------|-----|-----------|-------|-------|-------|-------|-------|-------|-------|------------------------|---|
|         |     | Byte0     | Byte1 | Byte2 | Byte3 | Byte4 | Byte5 | Byte6 | Byte7 |                        |   |
| 67F     | 8   | 40        | 31    | 61    | 01    | 00    | 00    | 00    | 00    | Read the current unit  | Receive   |
| 5FF     | 8   | 60        | 31    | 61    | 01    | 00    | 00    | AB    | 00    | Current unit is psi    | Transmit  |
| 67F     | 8   | 40        | 30    | 61    | 01    | 00    | 00    | 00    | 00    | Read process value     | Receive   |
| 5FF     | 8   | 60        | 30    | 61    | 01    | 50    | C3    | 00    | 00    | 50 psi                 | Transmit  |
| 67F     | 8   | 22        | 31    | 61    | 01    | 00    | 00    | 4E    | 00    | Change the unit to bar | Receive   |
| 5FF     | 8   | 60        | 31    | 61    | 01    | 00    | 00    | 00    | 00    | Return ok              | Transmit  |
| 67F     | 8   | 40        | 31    | 61    | 01    | 00    | 00    | 00    | 00    | Read the current unit  | Receive   |
| 5FF     | 8   | 60        | 31    | 61    | 01    | 00    | 00    | 4E    | 00    | Current unit is bar    | Transmit  |
| 67F     | 8   | 40        | 30    | 61    | 01    | 00    | 00    | 00    | 00    | Read process value     | Receive   |
| 5FF     | 8   | 60        | 30    | 61    | 01    | 78    | 0D    | 00    | 00    | 3.448 bar              | Transmit  |

The units can be stored in EEPROM by using the store command, i.e. object 0x1010. Also the default unit of PSI can be restored using the restore command i.e. object 0x1011. Table 20 provides a list of units that the Digital Pressure Sensor with CANopen<sup>®</sup>, Model DPS, supports.

**Table 20. Units Supported by the Digital Pressure Sensor with CANopen<sup>®</sup>, Model DPS**

| Unit Type | Unit | Code        |
|-----------|------|-------------|
| Non-SI    | psi  | 00 00 AB 00 |
| SI        | Bar  | 00 00 4E 00 |
| SI        | KPa  | 00 00 22 03 |

## 7.3 PDO Mapping

The Digital Pressure Sensor with CANopen<sup>®</sup>, Model DPS, allows two different objects to be mapped into the process data object:

1. Pressure in signed integer format (default)
2. Raw pressure data

The mappable objects are shown in Table 21.

**Table 21. Objects That Can Be Mapped to the PDO**

| Object (hex) | Sub Index (hex) | Description             |
|--------------|-----------------|-------------------------|
| 6130         | 1               | Pressure reading REAL32 |
| 7100         | 1               | Pressure reading INT16  |

The default mapping of the Digital Pressure Sensor with CANopen<sup>®</sup>, Model DPS, is shown in Table 22.

**Table 22. Digital Pressure Sensor with CANopen<sup>®</sup> Initial PDO Map**

| Object Number (hex) | Sub Index (hex) | Value (hex) | Description  |
|---------------------|-----------------|-------------|--|
| 1A00                | 00              | 01          | 1 object mapped  |
| 1A00                | 01              | 20013061    | 1st object is process value stored at 6130, sub index 1, length 32 bits. This can be changed to filed value 7100, subindex 1, length 16 bits |

## CHAPTER 8 - SERVICE DATA OBJECTS

The Service Data Object (SDO) is used to access the object dictionary (OD) of a device. The requester of the OD access is called the client and the CANopen<sup>®</sup> device, whose OD is accessed and services the request, is called the server. The client CAN-message as well as the reply server CAN-message always contains 8 bytes (although not all bytes necessarily contain meaningful data). A client request is always confirmed by a reply from the server. The Digital Pressure Sensor with CANopen<sup>®</sup>, Model DPS, supports only one server SDO and no client SDOs.

### 8.1 SDO Transfer

There are two mechanisms for SDO transfer:

- Expedited transfer: used for data objects up to 4 bytes in length.
- Segmented transfer: for objects with length > 4 bytes.

The Digital Pressure Sensor with CANopen<sup>®</sup>, Model DPS, allows only expedited SDO access (single CAN frame read/write and response) to (and from) the object dictionary.

The Model DPS is capable of detecting errors within the SDO protocol. If an error is detected then the Digital Pressure Sensor with CANopen<sup>®</sup>, Model DPS, replies with an SDO abort message. Table 23 contains the supported abort codes and their description.

**Table 23. SDO**

| Abort Code (hex)          | Description  |
|---------------------------|--|
| 0504<br>001160504<br>0001 | Client/server command specifier not valid or unknown   |
| 0601 0001                 | Attempt to read a write only object. Attempt to read a write only object. Attempt to read a write only object. Attempt to read a write only object to read. Attempt to read a write only object. Attempt to read a write only object |
| 0601 0002                 | Attempt to write a read only object  |
| 0602 0000                 | Object does not exist in object dictionary   |
| 0604 0041                 | Object cannot be mapped to the PDO   |
| 0609 0011                 | Sub-index does not exist. Attempt to read a write-only object. Attempt to read a write-only object   |
| 0609 0031                 | Value of parameter exceeded (only for write access) Value of parameter exceeded (only for write access) Value of parameter exceeded (only for write access)  |
| 0800 0000                 | General error  |



## CHAPTER 9 - EMERGENCY OBJECTS

The Digital Pressure Sensor with CANopen®, Model DPS, will transmit an emergency object if an internal error is detected or a source of error is removed. The Model DPS supports the error codes listed in Table 24.

### 9.1 Supported Emergency Codes

**Table 24. Digital Pressure Sensor with CANopen® Supported Emergency Codes**

| Emergency Error Code | Error Register | Description               |
|----------------------|----------------|---------------------------|
| 2201                 | 03             | Sensor failure            |
| 3201                 | 05             | Over flow / under flow    |
| 5000                 | 81             | EEPROM error              |
| 8120                 | 11             | CAN in error passive mode |
| 8140                 | 11             | Recovered from bus off    |

## CHAPTER 10 - OPERATION

This section describes the fundamental operation and configurations available for the Digital Pressure Sensor with CANopen®, Model DPS. The object dictionary supported is provided in Appendix 1.

### 10.1 Getting Pressure Data

The Digital Pressure Sensor with CANopen®, Model DPS, by default sends out 32 bit pressure data (in decimalized integer format, in psi units), every 100 millisecond. Table 25 shows the sequence of messages necessary to obtain the pressure reading from the Model DPS. Provide the excitation voltage to the Digital Pressure Sensor with CANopen®, Model DPS, transmits boot-up message to PC on identifier 77F. Host application transmits START REMOTE NODE command. When START REMOTE NODE command is transmitted, by the host, the Model DPS starts transmitting the PDO containing the 32-bit pressure data (in decimalized integer format, in psi units) every 100 millisecond.

### 10.2 Interpreting the Pressure Data

The Digital Pressure Sensor with CANopen®, Model DPS, provides the pressure reading in 32 bit signed integer values of Intel format, i.e. LSB first. The actual value of the pressure reading depends on the number of decimal digits that should be used with these integer values. The decimal digits used can be read from the Model DPS using an SDO access to object 6132. In Digital Pressure Sensor with CANopen®, Model DPS, the number of decimal digits is 3. So the pressure data can be interpreted as 00000.005 psi.

**Table 25. Getting the Pressure Data**

| ID (hex) | DLC | Data (hex) |       |       |       |       |       |       |       | Description   | Direction w.r.t Digital Pressure Sensor with CANopen® |
|----------|-----|------------|-------|-------|-------|-------|-------|-------|-------|---|---|
|          |     | Byte0      | Byte1 | Byte2 | Byte3 | Byte4 | Byte5 | Byte6 | Byte7 |   |   |
| 77F      | 1   | 00         |       |       |       |       |       |       |       | Boot-up message. Node ID 7F   | Transmit  |
| 000      | 2   | 01         | 7F    |       |       |       |       |       |       | Send command with node Id 7F  | Receive   |
| 1FF      | 4   | 05         | 00    | 00    | 00    |       |       |       |       | Digital Pressure Sensor with CANopen®, Model DPS, starts transmitting PDO containing the pressure data every 100 milliseconds | Transmit  |

## 10.3 Mapping Raw Pressure Data in PDO

Table 26 shows the procedure to map the Raw Pressure data into PDO.

## 10.4 Transmission type configuration

The Digital Pressure Sensor with CANopen<sup>®</sup>, Model DPS, can be configured to give out the pressure reading in three different ways:

1. The PDO is transmitted when a SYNC pulse is received, providing the data is marked as updated. The data is marked as updated whenever the pressure data changes. An example of this transmission type is shown in Table 20.

2. The PDO is transmitted with every nth SYNC pulse received, where n is a value
3. Between 1 and 240. An example of this transmission type is shown in Table 21.
4. The PDO is transmitted when the Digital Pressure Sensor with CANopen<sup>®</sup>, Model DPS, event timer expires which happens every 100 millisecond by default. This event timer value can be configured using the object 1800 with subindex 05. This transmission type is independent of the SYNC pulse. An example of this transmission type is shown in Table 22.

**Table 26. Map Raw Pressure Data into PDO**

| ID (hex) | DLC | Data (hex) |       |       |       |       |       |       |       | Description            | Direction w.r.t Digital Pressure Sensor with CANopen <sup>®</sup> |
|----------|-----|------------|-------|-------|-------|-------|-------|-------|-------|------------------------|---|
|          |     | Byte0      | Byte1 | Byte2 | Byte3 | Byte4 | Byte5 | Byte6 | Byte7 |                        |   |
| 67F      | 8   | 22         | 00    | 18    | 01    | FF    | 01    | 00    | C0    | Disable PDO            | Receive   |
| 5FF      | 8   | 60         | 00    | 18    | 01    | 00    | 00    | 00    | 00    | Return OK              | Transmit  |
| 67F      | 8   | 22         | 00    | 1A    | 00    | 00    | 00    | 00    | 00    | Write TPDO MAP disable | Receive   |
| 5FF      | 8   | 60         | 00    | 1A    | 00    | 00    | 00    | 00    | 00    | Return ok              | Transmit  |
| 67F      | 8   | 22         | 00    | 1A    | 01    | 10    | 01    | 00    | 71    | Change mapping         | Receive   |
| 5FF      | 8   | 60         | 00    | 1A    | 01    | 00    | 00    | 00    | 00    | Return ok              | Transmit  |
| 67F      | 8   | 2F         | 00    | 1A    | 00    | 01    | 00    | 00    | 00    | Write TPDO MAP enable  | Receive   |
| 5FF      | 8   | 60         | 00    | 1A    | 00    | 00    | 00    | 00    | 00    | Return ok              | Transmit  |
| 67F      | 8   | 22         | 00    | 18    | 01    | FF    | 01    | 00    | 40    | Turn PDO on            | Receive   |
| 5FF      | 8   | 60         | 00    | 18    | 01    | 00    | 00    | 00    | 00    | Return OK              | Transmit  |

**Table 27. Synchronous Acyclic PDO Transmission**

| ID (hex) | DLC | Data (hex) |       |       |       |       |       |       |       | Description   | Direction w.r.t Digital Pressure Sensor with CANopen <sup>®</sup> |
|----------|-----|------------|-------|-------|-------|-------|-------|-------|-------|---|---|
|          |     | Byte0      | Byte1 | Byte2 | Byte3 | Byte4 | Byte5 | Byte6 | Byte7 |   |   |
| 67F      | 8   | 22         | 00    | 18    | 02    | 00    | 00    | 00    | 00    | Change the transmission type to synchronous (acyclic)   | Receive   |
| 5FF      | 8   | 60         | 00    | 18    | 02    | 00    | 00    | 00    |       | Return ok   | Transmit  |
| 80       | 0   |            |       |       |       |       |       |       |       | SYNC command  | Receive   |
| 1FF      | 4   | 00         | 10    | 00    | 00    |       |       |       |       | Digital Pressure Sensor with CANopen <sup>®</sup> , Model DPS, transmits the pressure data if it has changed from the previous value. [1 psi] | Transmit  |
| 80       | 0   |            |       |       |       |       |       |       |       | SYNC command  | Receive   |
| 1FF      | 4   | 00         | 20    | 00    | 00    |       |       |       |       | Digital Pressure Sensor with CANopen <sup>®</sup> , Model DPS, transmits the pressure data if it has changed from the previous value. [2 psi] | Transmit  |

**Table 28. Synchronous Cyclic PDO Transmission (Cyclic with Every Sync)**

| ID (hex) | DLC | Data (hex) |       |       |       |       |       |       |       | Description   | Direction w.r.t Digital Pressure Sensor with CANopen <sup>®</sup> |
|----------|-----|------------|-------|-------|-------|-------|-------|-------|-------|---|---|
|          |     | Byte0      | Byte1 | Byte2 | Byte3 | Byte4 | Byte5 | Byte6 | Byte7 |   |   |
| 67F      | 8   | 22         | 00    | 18    | 02    | 03    | 00    | 00    | 00    | Change the transmission type to synchronous (cyclic). The Digital Pressure Sensor with CANopen <sup>®</sup> , Model DPS, should transmit data on 3rd SYNC | Receive   |
| 5FF      | 8   | 60         | 00    | 18    | 02    | 00    | 00    | 00    |       | Return ok   | Transmit  |
| 80       | 0   |            |       |       |       |       |       |       |       | SYNC command  | Receive   |
| 80       | 0   |            |       |       |       |       |       |       |       | SYNC command  | Receive   |
| 80       | 0   |            |       |       |       |       |       |       |       | SYNC command  | Receive   |
| 1FF      | 4   | 00         | 20    | 00    | 00    |       |       |       |       | Digital Pressure Sensor with CANopen <sup>®</sup> , Model DPS, transmits the pressure data reception of 3rd SYNC commands. [2 psi]                        | Transmit  |

**Table 29. Asynchronous PDO Transmission**

| ID (hex) | DLC | Data (hex) |       |       |       |            |       |       |       | Description   | Direction w.r.t Digital Pressure Sensor with CANopen <sup>®</sup> |
|----------|-----|------------|-------|-------|-------|------------|-------|-------|-------|---|---|
|          |     | Byte0      | Byte1 | Byte2 | Byte3 | Byte4      | Byte5 | Byte6 | Byte7 |   |   |
| 67F      | 8   | 22         | 00    | 18    | 02    | FE (or FF) | 00    | 00    | 00    | Change the transmission type to acyclic. The Digital Pressure Sensor with CANopen <sup>®</sup> , Model DPS, transmits PDO every 100 millisecond | Receive   |
| 5FF      | 8   | 60         | 00    | 18    | 02    | 00         | 00    | 00    |       | Return ok   | Transmit  |
| 67F      | 8   | 22         | 00    | 18    | 05    | E8         | 03    | 00    | 00    | Write to PDO communications object event. Timer with value of 1000 mS.  | Receive   |
| 5FF      | 8   | 60         | 00    | 18    | 05    | 00         | 00    | 00    | 00    | The Digital Pressure Sensor with CANopen <sup>®</sup> , Model DPS, starts transmitting the PDO every 1000 millisecond                           | Transmit  |

## 10.5 Calibration

The Digital Pressure Sensor with CANopen<sup>®</sup>, Model DPS, allows auto zero correction by using the object 0x6125. When autozero correction is applied, all the objects associated with process value are changed internally by the Model DPS. The objects related to process value are given in Table 18. An example of how to achieve zero correction is shown in the Table 30.

The auto zero value can be stored in EEPROM by using the store command, i.e. object 0x1010. Also the default offset can be restored using the restore command, i.e. object 0x1011.

**Table 30. Auto Zero Command**

| ID (hex)            | DLC | Data (hex) |       |       |       |       |       |       |       | Description  | Direction w.r.t Digital Pressure Sensor with CANopen <sup>®</sup> |
|---------------------|-----|------------|-------|-------|-------|-------|-------|-------|-------|--|---|
|                     |     | Byte0      | Byte1 | Byte2 | Byte3 | Byte4 | Byte5 | Byte6 | Byte7 |  |   |
| Apply Zero Pressure |     |            |       |       |       |       |       |       |       |  |   |
| 67F                 | 8   | 22         | 25    | 61    | 01    | 7A    | 65    | 72    | 6F    | Performs an auto zero on the current pressure reading. Whatever was the offset when zero pressure is applied will now be nullified | Receive   |
| 5FF                 | 8   | 60         | 25    | 61    | 01    | 00    | 00    | 00    | 00    | Return ok  | Transmit  |

## APPENDIX - OBJECT DICTIONARY

### Communication Profile Objects 0x1000 – 0x1FFF

| Index  | SubIndex           | Name                          | Description  |
|--------|--------------------|-------------------------------|--|
| 0x1000 | 0x00               | Device type                   | The object describes the type of the logical device and its functionality  |
| 0x1001 | 0x00               | Error register                | This object provided error information. The CANopen <sup>®</sup> device maps internal errors into this object. It is a part of an emergency object   |
| 0x1003 | 0x00               | Pre-defined error field       | This object provides the errors that occurred on the CANopen <sup>®</sup> device and were signaled via the emergency object. In doing so it provides an error history  |
| 0x1005 | 0x00               | COB-ID sync message           | This object indicates the configured COB-ID of the synchronization object (SYNC). Further, it defines whether the CANopen <sup>®</sup> device generates the SYNC   |
| 0x1008 | 0x00               | Manufacturer device name      | This object provides the name of the device as given by the manufacturer   |
| 0x1009 | 0x00               | Manufacturer hardware version | This object provides the manufacturer hardware version description   |
| 0x100A | 0x00               | Manufacturer software version | This object provides the manufacturer software version description   |
| 0x1010 | 0x00-0x01          | Store parameters              | This object controls the saving of parameters in non-volatile memory. This command stores: 1) input offset, 2) span end, 3) span start, 4) heartbeat time, 5) physical units, 6) auto zero, and 7) span  |
| 0x1011 | 0x00-0x01          | Restore default parameters    | With this object, the default values of parameters according to the communication profile, device profile, and application profile are restored. This command restores 1) input offset, 2) span end, 3) span start, 4) heartbeat time, 5) physical units, 6) autozero, and 7) span |
| 0x1014 |                    | COB-ID EMCY                   | This object indicates the configured COB-ID for the EMCY write service   |
| 0x1017 |                    | Producer heartbeat time       | The producer heartbeat time indicates the configured cycle time of the heartbeat   |
| 0x1018 | 0x00-0x04          | Identity object               | This object provides general identification information of the CANopen <sup>®</sup> device   |
| 0x1200 | 0x00-x02           | SDO server parameter          |  |
| 0x1800 | 0x00-0x02 and 0x05 | TPDO communication parameter  | This object contains the communication parameters for the PDOs the CANopen <sup>®</sup> device is able to transmit   |
| 0x1A00 | 0x00-0x08          | TPDO mapping parameter        | This object contains the mapping for the PDOs the device is able to transmit   |

## APPENDIX - OBJECT DICTIONARY, continued

### CiA Device Profile Objects 0x6000 – 0x9FFFF

| Index  | SubIndex  | Name                       | Description  |
|--------|-----------|----------------------------|--|
| 0x6110 | 0x00-x01  | AI sensor type             | Specifies the type of sensor, which is connected to the analogue input   |
| 0x6124 | 0x00-0x01 | AI input offset            | This object defines the additional offset value for the analogue input channel. It is scaled in physical unit of process value                                       |
| 0x6125 | 0x00-0x01 | Auto sero                  | Writing a signature value of "zero" to this object way that the actual AI input PV becomes zero. Along with the input offset value, this cycle is performed one time |
| 0x6131 | 0x00-x01  | AI physical units          | This object assigns SI units and prefixes for the process values within the analogue input function block  |
| 0x6132 | 0x00-x01  | AI decimal digits          | This object describes the number of decimal digits following the decimal point for interpretation of data types Integer8, Integer16, and Integer32                   |
| 0x6148 | 0x00-0x01 | AI span start              | This value specifies the lower limit where process values are expected. Process values that are lower than this limit are marked as negative overloaded              |
| 0x6149 | 0x00-0x01 | AI span end                | This value specifies the upper limit where process values are expected. Process values exceeding this limit are marked as positive overloaded                        |
| 0x6130 | 0x00-x01  | AI process value (integer) | This object represents the result of the input scaling block and gives the measured quantity scaled in the physical unit of process values                           |
| 0x7100 | 0x00-x01  | AI field value (integer)   | This object represents the raw ADC counts  |

### Manufacturer Specific Objects 0x2000- 0x27FF

| Index  | SubIndex | Name                          | Description   |    |
|--------|----------|-------------------------------|---|----|
| 0x2002 | 0x00     | Acquisition time              | The time taken by the ADC to acquire data. The value to be expected is 15 microsecs     | RD |
| 0x2003 | 0x00     | Acquisition interval          | Time at which the data is captured form the ADC. The value to be expected is 1 millisec | RD |
| 0x2004 | 0x00     | Pressure span overflow count  | Counts the number of times the pressure value crosses the maximum span                  | RD |
| 0x2005 | 0x00     | Pressure span underflow count | Counts the number of times the pressure value crosses the minimum span                  | RD |
| 0x2006 | 0x00     | Pressure span                 | Pressure span value   | RD |
| 0x2007 | 0x00     | Last calibration year         | The year of the date on which it was calibrated last time                               | RD |
| 0x2008 | 0x00     | Last calibration month        | The month of the date on which it was calibrated last time                              | RD |
| 0x2009 | 0x00     | Last calibration day          | The day of the date on which it was calibrated last time                                | RD |
| 0x200A | 0x00     | Pressure coeff1               | Coefficient 1 used for calibration  | RD |
| 0x200B | 0        | Pressure coeff2               | Coefficient 2 used for calibration  | RD |
| 0x200C | 0        | Pressure offset               | Offset used for calibration   | RD |
| 0x200D | 0        | Sensor type                   | Type of sensor: 1 for absolute, 2 for gauge, 3 for differential                         | RD |
| 0x200E | 0        | Serial number                 | Serial number of the device   | RD |

## WARRANTY/REMEDY

Honeywell warrants goods of its manufacture as being free of defective materials and faulty workmanship. Honeywell's standard product warranty applies unless agreed to otherwise by Honeywell in writing; please refer to your order acknowledgment or consult your local sales office for specific warranty details. If warranted goods are returned to Honeywell during the period of coverage, Honeywell will repair or replace, at its option, without charge those items it finds defective.

**The foregoing is buyer's sole remedy and is in lieu of all other warranties, expressed or implied, including those of merchantability and fitness for a particular purpose. In no event shall Honeywell be liable for consequential, special, or indirect damages.**

While we provide application assistance personally, through our literature and the Honeywell web site, it is up to the customer to determine the suitability of the product in the application.

Specifications may change without notice. The information we supply is believed to be accurate and reliable as of this printing. However, we assume no responsibility for its use.

### Find out more

Honeywell serves its customers through a worldwide network of sales offices, representatives and distributors. For application assistance, current specifications, pricing or name of the nearest Authorized Distributor, contact your local sales office.

To learn more about Honeywell's test and measurement products, call **+1-614-850-5000**, visit **[measurementsensors.honeywell.com](http://measurementsensors.honeywell.com)**, or e-mail inquiries to **[info.tm@honeywell.com](mailto:info.tm@honeywell.com)**

### Honeywell Sensing and Productivity Solutions

9680 Old Bailes Road  
Fort Mill, SC 29707  
[honeywell.com](http://honeywell.com)

50085804, Rev. B IL50 GLO  
April 2016  
Copyright © 2016 Honeywell International Inc. All rights reserved.  
Hastelloy® is the registered trademark name of Haynes International, Inc.  
CiA® and CANopen® are registered trademarks of CAN in Automation e.V.

The Honeywell logo is displayed in a bold, red, sans-serif font.