

HD SERIES

004996

Issue 3

MICRO SWITCH Technology

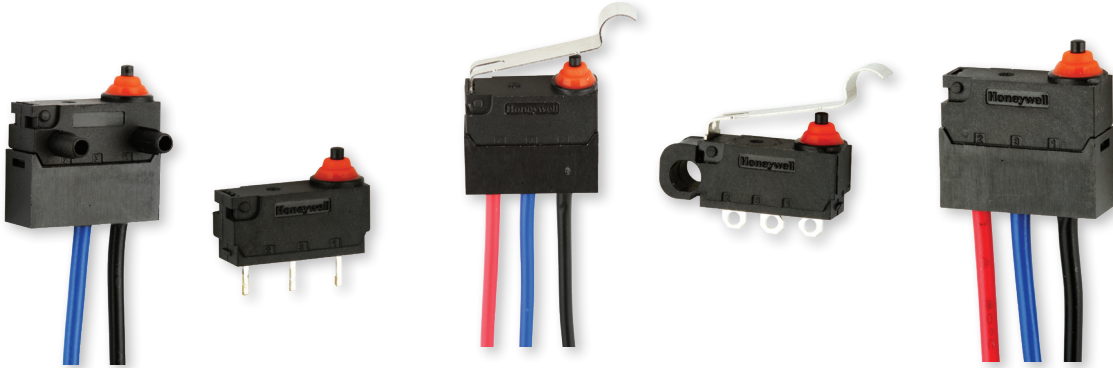

APPLICATIONS



Presence Detection

Ensures door latching and safe operation



Flow Switch

Enables safe and efficient water usage



Power Switch

Reliable system control for motors, pumps, fans



Operator Controls

Interface control for system auxiliary functions



Pressure Switch

Detection and warning of high pressure or over pressure events

VALUE PROPOSITION

The HD, Honeywell's sealed subminiature MICRO SWITCH family, provides a cost-conscious switching solution to assist in hitting overall system-level cost and design goals in high volume applications.

The HD switch provides a fully certified, reliable and repeatable solution over the lifetime of the product.

Value-add (wiring, molding, connectors) available for plug-and-play switch solutions.

HD FEATURES	HD BENEFITS	OUR VALUE
0.1 A & 3 A	Electrical ratings for design flexibility in one industry-standard package size	Competitive cross references available
> 500K mechanical operations	Globally certified for reliable, repeatable actuation for life	Snap-spring mechanism with more than 80 years of MICRO SWITCH service
UL/CSA, cUL, ENEC, CQC, RoHS and REACH compliant	Identical system designs for platform applications worldwide	Certifications enable global design acceptance and cost savings in agency approvals
Integrated pillars and mounting holes in switch housing	Simplifies installation, reduces time and cost for switch subassemblies	Configurable pillar options enable design flexibility for various switch orientations
Wiring, molding and connector value-add capabilities available	Delivers "plug-and-play" IP67-rated switch solutions	Reduction in supply chain complexity

Honeywell

MICRO SWITCH, HD SERIES

Unless otherwise stated, all characteristic measurements tested according to UL, EN and IEC standards and conditions. Parameters and acceptance criteria validated and confirmed in a certified lab environment. Technical details available upon request.

TABLE 1. PERFORMANCE SPECIFICATIONS

CHARACTERISTIC	MEASURE
Circuitry	SPDT, SPST-NO, SPST-NC
Operating force	130 gf max.
Termination	wired: straight, right, left solder: 2,5 mm x 2,5 mm with 1,3 mm dia. hole pcb: 0,6 mm x 3,5 mm pcb: left corner, right corner long solder: with 1,3 mm dia. hole straight solder: 2,0 mm x 2,5 mm
Actuators	pin plunger, lever, simulated roller lever, formed lever
Mounting	no pillar, right pillar, left pillar, no pillar (side mount), both pillars (side mount)
Agency certification	ENEC, CQC, UL, cUL
Certified mechanical life	500,000 cycles
Ingress protection rating	IP67 per IEC 60529 (wired) IP00 (terminal versions)
Vibration resistance	10 Hz to 55 Hz, displacement 1,5 mm (peak-to-peak); no contact separation > 1 millisecond
Shock resistance	destruction: 294 m/s ² (30 g max.); switch is functional after test malfunction: 100 m/s ² (10 g max.); no contact separation > 1 millisecond
Contact resistance (Initial)	200 mΩ max. as measured using 4-wire voltage drop method @ 6 Vdc and 100 mA
Dielectric strength	500 Vac for 1 minute; leakage current ≤10 mA between open contacts 1000 Vac for 1 minute, leakage current ≤10 mA between live parts and ground/between live parts and dead metal parts
Insulation resistance	min. 100 MegaΩ (500 Vdc for one minute)
Storage conditions	0°C to 40°C, max. 85 %RH
Contact material	silver alloy
Housing material	nylon
Auxiliary actuator material	stainless steel
Plunger material	nylon
Plunger seal material	silicon
Terminal material	silver-plated copper alloy
Average unit weight	3,3 g [0.007 lb]
Packaging dimensions	320 mm x 264 mm x 273 mm [12.6 in x 10.4 in x 10.75 in]
Packaging weight	5,1 kg [11.24 lb]

MICRO SWITCH, HD SERIES

TABLE 2. ELECTRICAL SPECIFICATIONS			
RATING	UL/CUL (CUL 61058-1, FILE 12252) AMERICAS	ENEC (IEC 61058-1) EUROPE	CQC (GB15092-1) ASIA-PACIFIC
3 mA	0.01 RA to 0.03 RA, 12 Vdc 10,000 cycles	0.01 A, 0.03 A, 12 Vdc, 100,000 cycles	0.01 A, 0.03 A, 12 Vdc, 100,000 cycles
3 A	3 RA, 12 Vdc, 100,000 cycles 3 RA, 125 Vac, 10,000 cycles (Use temp 55°C)	3 A, 12 Vdc, 100,000 cycles 3 A, 125 Vac, 10,000 cycles	3 A, 12 Vdc, 100,000 cycles 3 A, 125 Vac, 10,000 cycles

- RA = Resistive Amps (Resistive Load)

FIGURE 1. PRODUCT NOMENCLATURE

HD	20	S	01	A	0	2	A	M
Switch Type	Electrical Rating	Max. Operating Force @ Plunger	Termination	Actuator Type	Circuit Code	Mounting	Wire Size	Wire Type*
HD Series Sealed Subminiature Switch	20 3 mA 12 Vdc	S 130 gf max.	01 Wired, straight*	A Piin plunger	0 SPDT	1 No Pillar	A 20 AWG (standard)***	M UL 1007 (standard)
	30 3 A, 12 Vdc 3 A, 125 Vac		02 Wired, right*	B Lever	1 SPST-NO	2 Right Pillar	B 22 AWG***	N UL 1430
			03 Wired, left*	C Simulated roller	2 SPST-NC	3 Left Pillar	C 24 AWG	R AVSS
			20 Solder 2,5 mm x 2,5 mm with 1,3 mm dia. hole	D Formed lever		4 No Pillar Side Mount	D 26 AWG	
			30 PCB 0,6 mm x 3,5 mm			5 Both Pillars Side Mount	E 0,3 mm ² **	
			40 PCB, left corner					
			50 PCB, right corner					
			60 Long solder w/ 1,3 mm dia. hole					
			70 Straight solder 2,0 mm x 2,5 mm					

* Standard wire length is 150 mm [5,91 in]; other lengths available upon request
 ** Wire size "E" only applicable to AVSS wire type
 *** Wire sizes "A" and "B" only applicable to termination "01"

TABLE 3. WIRE SPECIFICATIONS	
WIRE GAUGE	INSULATION OUTSIDE DIAMETER
20	Ø1,80 [0.071]
22	Ø1,60 [0.063]
24	Ø1,40 [0.055]
26	Ø0,762 [0.030]
CHARACTERISTIC	MEASURE
Operating temperature (manufacturer specified)	terminal type S: -40°C to 125°C [-40°F to 257°F] wired type S (UL 1007/UL 1061): -20°C to 80°C [-4°F to 176°F] wired type S (UL 1430): -20°C to 85°C [-4°F to 185°F] wired type S (AVSS): -40°C to 85°C [-40°F to 185°F]

MICRO SWITCH, HD SERIES

ACTUATOR

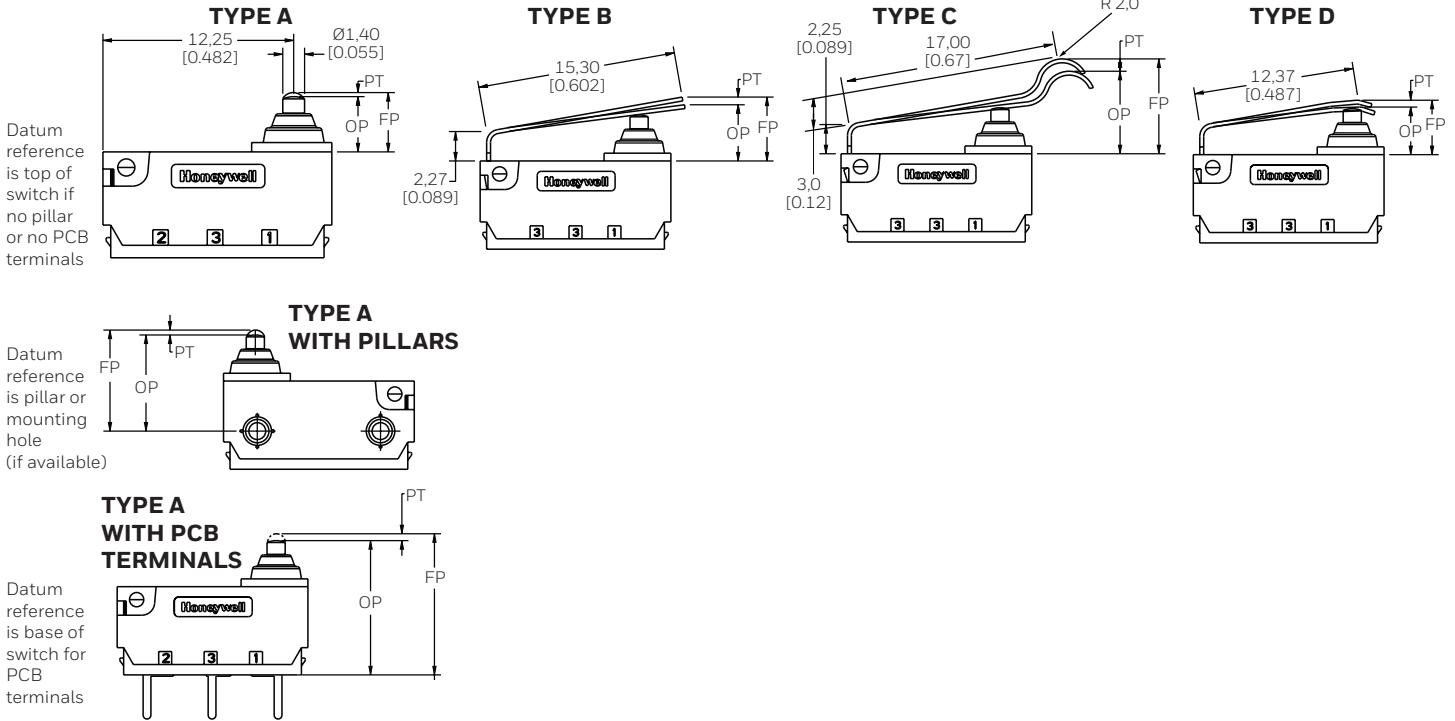

TABLE 4. SWITCH CHARACTERISTICS

CATALOG LISTING	OPERATE FORCE MAX. (gf)	RELEASE FORCE MIN. (GRAMS)	FREE POSITION MAX. (mm) NO HOLE OR PILLAR	FREE POSITION MAX. (mm) FROM HOLE OR PILLAR	FREE POSITION MAX. (mm) FROM BASE	OPERATE POINT (mm) NO HOLE OR PILLAR	OPERATE POINT (mm) FROM HOLE OR PILLAR	OPERATE POINT (mm) FROM BASE	PRETRAVEL MAX. (mm)	OVERTRAVEL MAX. (mm)	DIFFERENTIAL TRAVEL MAX. (mm)
A	130	13	3,55 ±0,3	7,25 ±0,3	10,35 ±0,3	3,05 ±0,3	6,75 ±0,3	9,85 ±0,3	0,80	0,8	0,3
B	200	25	5,00 ±0,6	8,70 ±0,6	11,80 ±0,6	3,70 ±0,6	7,4 ±0,6	10,5 ±0,6	3,5	0,6	0,6
C	200	25	9,30 ±0,6	13,00 ±0,6	16,0 ±0,6	6,8 ±0,6	10,5 ±0,6	13,6 ±0,6	3,5	1,8	0,6
D	220	25	4,20 ±0,6	7,90 ±0,6	11,0 ±0,6	3,4 ±0,6	7,10 ±0,5	10,2 ±0,5	3,0	0,6	0,6

MICRO SWITCH, HD SERIES

FIGURE 2. HD SERIES DIMENSIONS

PACKAGE DIMENSIONS

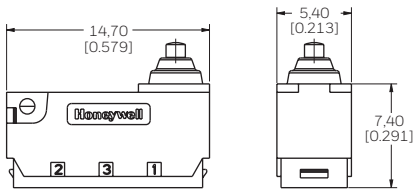

PILLAR DIMENSIONS

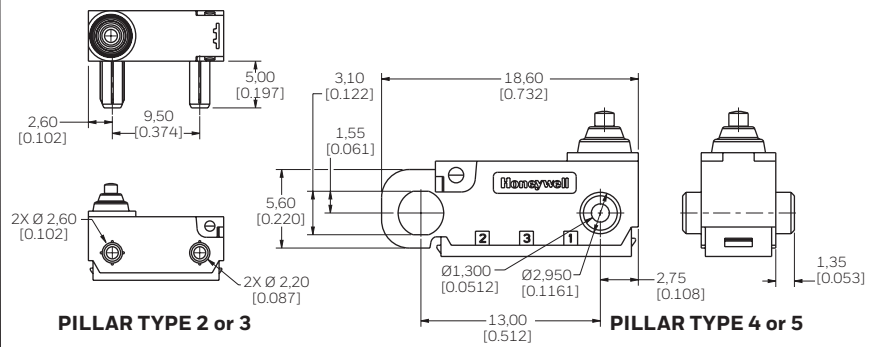

TERMINAL TYPE

TYPE 30

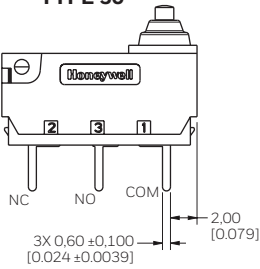

TYPE 40

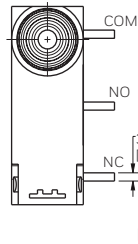

TYPE 50

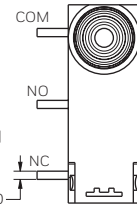

TYPE 20

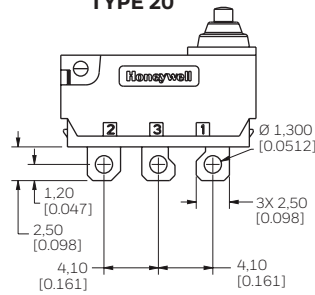

TYPE 70

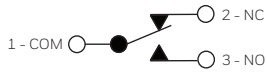
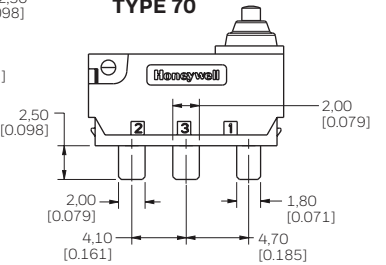

Circuit Diagram

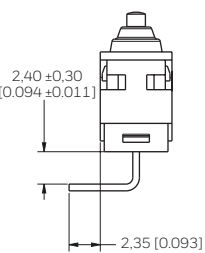
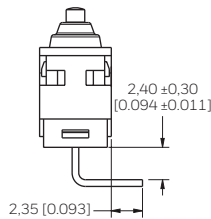

TYPE 60

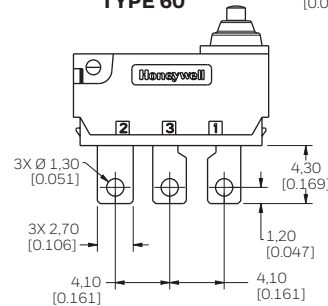

WIRE-EXIT VARIATIONS

TYPE 01-STRAIGHT

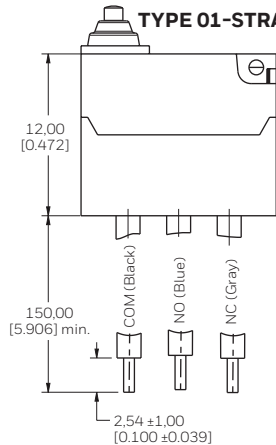

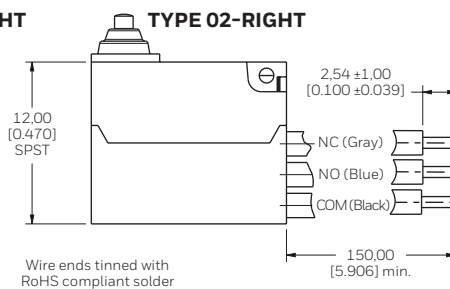

TYPE 02-RIGHT

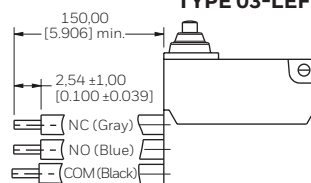

TYPE 03-LEFT



HONEYWELL SEALED SUBMINIATURE BASIC PORTFOLIO

	ZW	ZD	HD
			
Target Market	Applications that require extended lifecycles, configurations, and high temperature requirements	Applications that require flexibility in design with special configurations available	Cost-sensitive applications requiring configurability in actuation and termination
Differentiator	Logic level and power duty (6 A, 250 Vac) amp ratings	Designed to operate in harsh environments that require special lever and terminal designs or wire types	Industry standard switch footprint and global certifications ideal for “low-cost-of-failure” applications
Options	Extended temperature range: -40°C to 120°C unwired	Multiple contact variants to enable design and regulation compliance	Integrated mounting pins for reduced installation time

RELATED DOCUMENTATION

- Submin Comparison Chart
- Applying Precision Switches
- ZW datasheet
- ZD datasheet

FOR MORE INFORMATION

Honeywell Advanced Sensing Technologies services its customers through a worldwide network of sales offices and distributors. For application assistance, current specifications, pricing, or the nearest Authorized Distributor, visit sps.honeywell.com or call:

USA/Canada	+302 613 4491
Latin America	+1 305 805 8188
Europe	+44 1344 238258
Japan	+81 (0) 3-6730-7152
Singapore	+65 6355 2828
Greater China	+86 4006396841

Honeywell

Advanced Sensing Technologies

830 East Arapaho Road
Richardson, TX 75081
sps.honeywell.com

WARRANTY/REMEDY

Honeywell warrants goods of its manufacture as being free of defective materials and faulty workmanship during the applicable warranty period. Honeywell's standard product warranty applies unless agreed to otherwise by Honeywell in writing; please refer to your order acknowledgment or consult your local sales office for specific warranty details. If warranted goods are returned to Honeywell during the period of coverage, Honeywell will repair or replace, at its option, without charge those items that Honeywell, in its sole discretion, finds defective. **The foregoing is buyer's sole remedy and is in lieu of all other warranties, expressed or implied, including those of merchantability and fitness for a particular purpose. In no event shall Honeywell be liable for consequential, special, or indirect damages.**

While Honeywell may provide application assistance personally, through our literature and the Honeywell web site, it is buyer's sole responsibility to determine the suitability of the product in the application.

Specifications may change without notice. The information we supply is believed to be accurate and reliable as of this writing. However, Honeywell assumes no responsibility for its use.

⚠️ WARNING **IMPROPER INSTALLATION**

- Consult with local safety agencies and their requirements when designing a machine-control link, interface and all control elements that affect safety.
- Strictly adhere to all installation instructions.

Failure to comply with these instructions could result in death or serious injury.

⚠️ WARNING **MISUSE OF DOCUMENTATION**

- The information presented in this product sheet is for reference only. Do not use this document as a product installation guide.
- Complete installation, operation, and maintenance information is provided in the instructions supplied with each product.

Failure to comply with these instructions could result in death or serious injury.