

HD1 SERIES

004997

Issue 3

MICRO SWITCH Technology

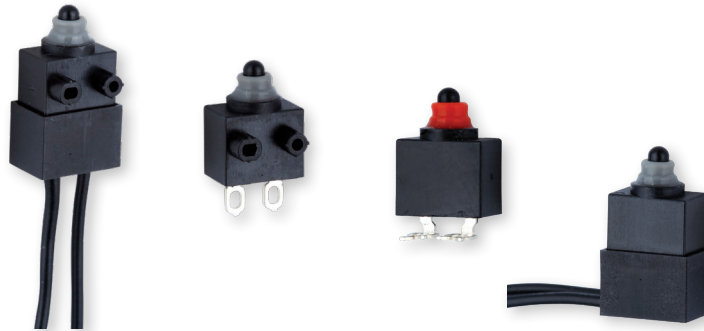

APPLICATIONS



Presence Detection

Ensures door latching and safe operation



Flow Switch

Enables safe and efficient water usage



Power Switch

Reliable system control for motors, pumps, fans



Operator Controls

Interface control for system auxiliary functions



Pressure Switch

Detection and warning of high pressure or over pressure events

VALUE PROPOSITION

The HD1, Honeywell's sealed subminiature MICRO SWITCH family, provides a small-footprint switching solution to assist in hitting overall system-level size and design goals in high volume applications.

The HD1 switch provides a fully certified, reliable, and repeatable solution over the lifetime of the product. Slow-action mechanism enables compact switch footprint and design.

HD1 FEATURES	HD1 BENEFITS	OUR VALUE
0.1 A, SPNC & SPNO circuitry	Electrical ratings for design flexibility in a small switch footprint	Competitive cross references available
Slow-acting switching mechanism	Globally certified for reliable, repeatable actuation for life	Simpler mechanical construction and smaller overall solution footprint
UL/CSA, cUL, ENEC, CQC, RoHS and REACH compliant	Identical system designs for platform applications worldwide	Certifications enable global design acceptance and cost savings in agency approvals
Integrated pillars and mounting holes in switch housing	Simplifies installation, reduces time and cost for switch subassemblies	Configurable pillar options enable design flexibility for various switch orientations
Wiring, molding and connector value-add capabilities available	Delivers "plug-and-play" IP67-rated switch solutions	Reduction in supply chain complexity

Honeywell

MICRO SWITCH, HD1 SERIES

Unless otherwise stated, all characteristic measurements tested according to UL, EN and IEC standards and conditions. Parameters and acceptance criteria validated and confirmed in a certified lab environment. Technical details available upon request.

TABLE 1. PERFORMANCE SPECIFICATIONS

CHARACTERISTIC	MEASURE
Circuitry	SPNC, SPNO
Operating force	100 gf max., 130 gf max., 200 gf max.
Termination	wired: downward, side pcb: straight, angle long solder clips special
Actuators	pin plunger, special
Mounting	no pillar, right pillar, left pillar, both pillars, special
Agency certification	ENEC, CQC, UL, cUL
Certified mechanical life	300,000 cycles
Ingress protection rating	IP67 per IEC 60529 (wired) IP00 (terminal versions)
Vibration resistance	10 Hz to 55 Hz, displacement 1,5 mm (peak-to-peak); no contact separation > 1 millisecond
Shock resistance	destruction: 294 m/s ² (30 g max.); switch is functional after test malfunction: 100 m/s ² (10 g max.); no contact separation > 1 millisecond
Contact resistance	500 mΩ max. as measured using 4-wire voltage drop method @ 6 Vdc and 100 mA
Dielectric strength	500 Vac for 1 minute; leakage current ≤10 mA between open contacts 500 Vac for 1 minute, leakage current ≤10 mA between live parts and ground/between live parts and dead metal parts
Insulation resistance	min. 100 MegaΩ (500 Vdc for one minute)
Storage conditions	0°C to 40°C, max. 85 %RH
Stationary contact/terminal material	silver-plated copper alloy
Housing material	pbt
Plunger material	acetal (POM) copolymer
Plunger seal material	silicon
Average unit weight	1,5 g [0.004 lb]
Packaging dimensions	203 mm x 264 mm x 273 mm [8 in x 10.4 in x 10.75 in]
Packaging weight	3,3 kg [7.28 lb]

MICRO SWITCH, HD1 SERIES

TABLE 2. ELECTRICAL SPECIFICATIONS

RATING	UL/CUL (CUL 61058-1, FILE 12252) AMERICAS	ENEC (IEC 61058-1) EUROPE	CQC (GB15092-1) ASIA-PACIFIC
0.1 A	0.01 RA, 12 Vdc 10,000 cycles (Use temp 55°C)	0.01 A, 12 Vdc, 100,000 cycles (Use temp 0°C to 55°C)	0.01 A, 12 Vdc, 100,000 cycles

- RA = Resistive Amps (Resistive Load)

FIGURE 1. PRODUCT NOMENCLATURE

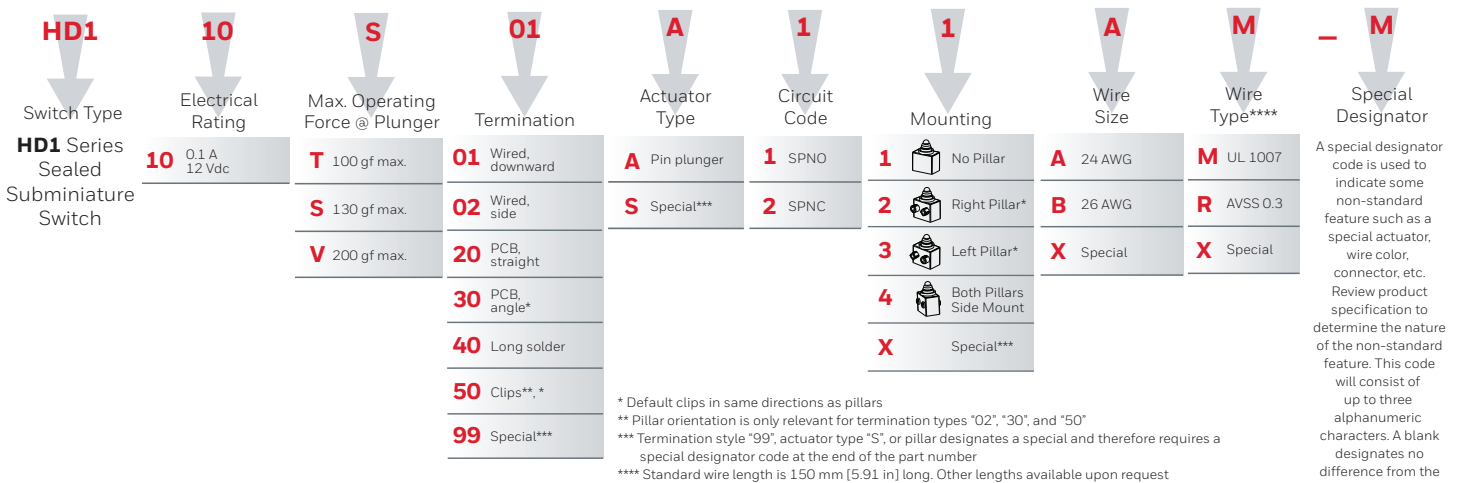
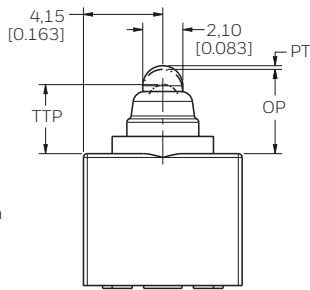

TABLE 3. WIRE SPECIFICATIONS

WIRE GAUGE	INSULATION OUTSIDE DIAMETER
24	Ø1,40 [0.055]
26	Ø0,762 [0.030]
CHARACTERISTIC	MEASURE
Operating temperature (manufacturer specified)	terminal type: -40°C to 85°C [-40°F to 185°F] wired type (UL 1007/UL 1061): -20°C to 80°C [-4°F to 176°F] wired type (UL 1430): -20°C to 85°C [-4°F to 185°F] wired type (AVSS): -40°C to 85°C [-40°F to 185°F]

MICRO SWITCH, HD1 SERIES

ACTUATOR



Datum reference is top of switch if no pillar or no pcb terminals

PILLAR TYPE 1

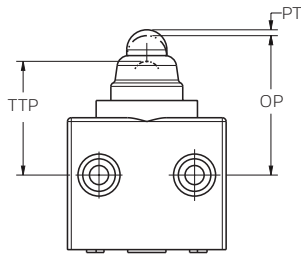

Datum reference is pillars

PILLAR TYPE 2, 3, AND 4

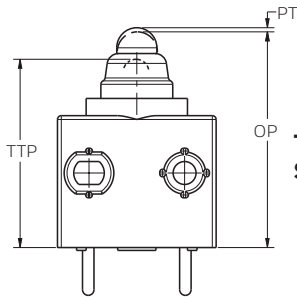

Datum reference is base of switch for pcb terminals

TERMINAL STYLE 20 AND 30

MARKING INFORMATION

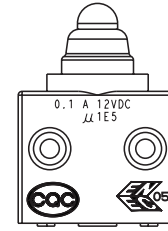
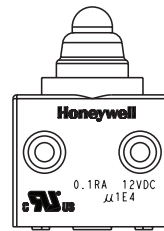

Note: "Honeywell" name will be tool marked and rating symbols will be laser marked.

TABLE 4. SWITCH OPERATING CHARACTERISTICS

CATALOG LISTING	OPERATE FORCE MAX. (gf)	PRETRAVEL (mm) MAX.	OVERTRAVEL (mm) MAX.	OPERATE POINT (mm) FROM TOP OF SWITCH	OPERATE POINT (mm) FROM PILLARS	OPERATE POINT (mm) FROM BASE	TOTAL TRAVEL POSITION (mm) FROM TOP OF SWITCH MIN.	TOTAL TRAVEL POSITION (mm) FROM PILLARS MIN.	TOTAL TRAVEL POSITION (mm) FROM BASE MIN.
HD110T	100	1	1,1	4,1 +0,2/-0,4	7,1 +0,2/-0,4	11,1 +0,2/-0,4	2,0	6,0	10,0
HD110S	130	1	1,1	4,1 +0,2/-0,4	7,1 +0,2/-0,4	11,1 +0,2/-0,4	2,0	6,0	10,0
HD110V	200	1	1,1	4,1 +0,2/-0,4	7,1 +0,2/-0,4	11,1 +0,2/-0,4	2,0	6,0	10,0

MICRO SWITCH, HD1 SERIES

FIGURE 2. HD1 SERIES DIMENSIONS

PACKAGE DIMENSIONS

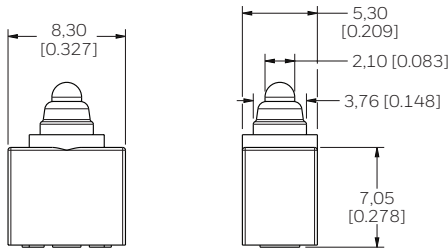

PILLAR TYPE 1

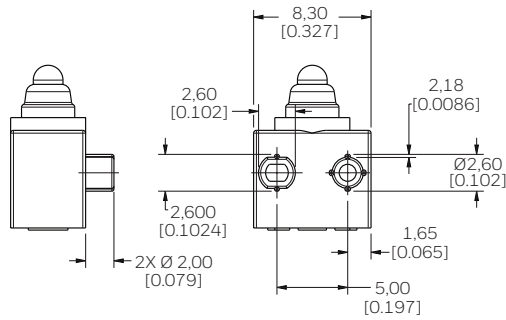

PILLAR TYPE 2 (RIGHT PILLAR)

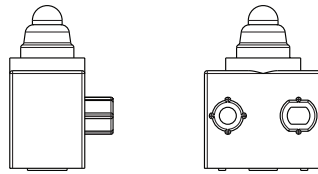

PILLAR TYPE 3 (LEFT PILLAR)

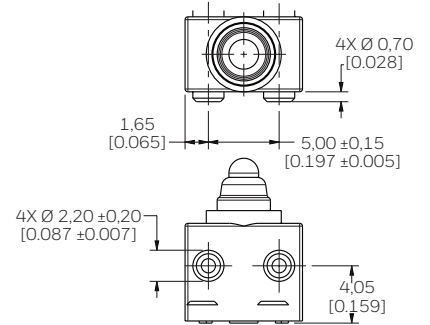

PILLAR TYPE 4

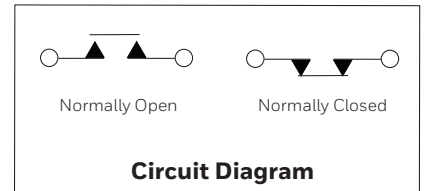

TERMINAL DIMENSIONS

TYPE 30 TERMINALS WITH TYPE 2 PILLARS

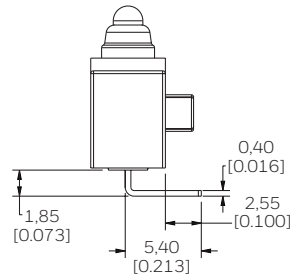

TYPE 30 TERMINALS WITH TYPE 3 PILLARS

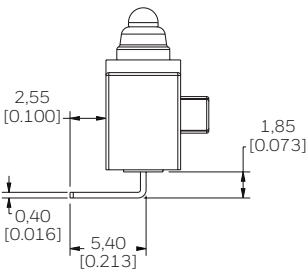

TYPE 20

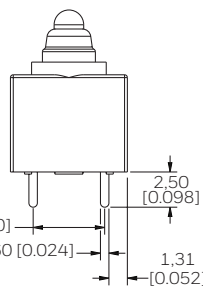

TYPE 01-WIRED

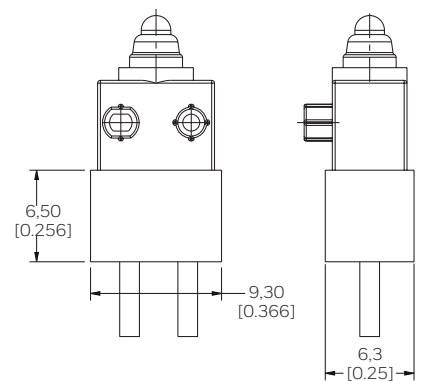

TYPE 40

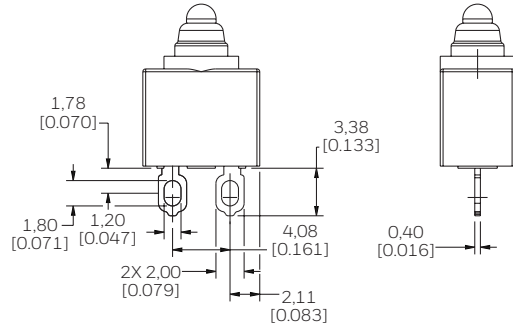

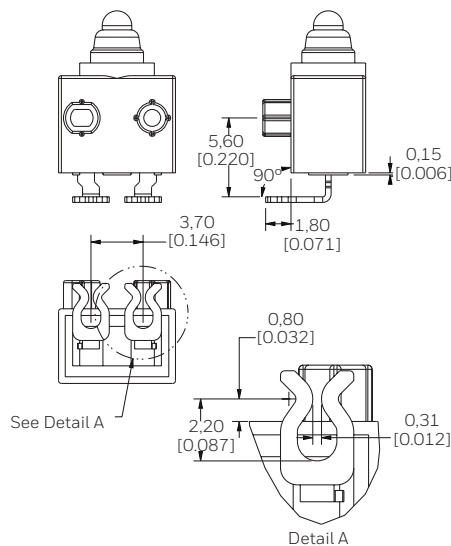

TYPE 50

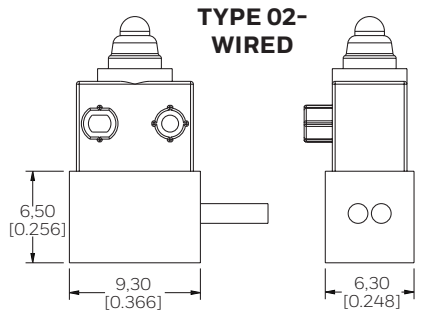

TYPE 02-WIRED



HONEYWELL SEALED SUBMINIATURE BASIC PORTFOLIO

	ZD	HD	HD1
			
Target Market	Applications that require flexibility in design with special configurations available	Cost-sensitive applications requiring configurability in actuation and termination	Applications that require slow-action mechanism and small overall design footprint
Differentiator	Logic level and power-duty (3 A, 125 Vac) amp ratings	Industry standard switch footprint and global certifications ideal for “low-cost-of-failure” applications	Smallest sealed switch footprint in the Honeywell MICRO SWITCH portfolio
Options	Multiple contact variants to enable design and regulation compliance	Integrated mounting pins for reduced installation time	Special levers, terminals and wiring options available

RELATED DOCUMENTATION

- Submin Comparison Chart
- Applying Precision Switches
- ZD datasheet
- ZW datasheet

FOR MORE INFORMATION

Honeywell Advanced Sensing Technologies services its customers through a worldwide network of sales offices and distributors. For application assistance, current specifications, pricing, or the nearest Authorized Distributor, visit sps.honeywell.com/ast or call:

USA/Canada	+302 613 4491
Latin America	+1 305 805 8188
Europe	+44 1344 238258
Japan	+81 (0) 3-6730-7152
Singapore	+65 6355 2828
Greater China	+86 4006396841

Honeywell

Advanced Sensing Technologies

830 East Arapaho Road
Richardson, TX 75081
sps.honeywell.com/ast

WARRANTY/REMEDY

Honeywell warrants goods of its manufacture as being free of defective materials and faulty workmanship during the applicable warranty period. Honeywell's standard product warranty applies unless agreed to otherwise by Honeywell in writing; please refer to your order acknowledgment or consult your local sales office for specific warranty details. If warranted goods are returned to Honeywell during the period of coverage, Honeywell will repair or replace, at its option, without charge those items that Honeywell, in its sole discretion, finds defective. **The foregoing is buyer's sole remedy and is in lieu of all other warranties, expressed or implied, including those of merchantability and fitness for a particular purpose. In no event shall Honeywell be liable for consequential, special, or indirect damages.**

While Honeywell may provide application assistance personally, through our literature and the Honeywell web site, it is buyer's sole responsibility to determine the suitability of the product in the application.

Specifications may change without notice. The information we supply is believed to be accurate and reliable as of this writing. However, Honeywell assumes no responsibility for its use.

⚠ WARNING IMPROPER INSTALLATION

- Consult with local safety agencies and their requirements when designing a machine-control link, interface and all control elements that affect safety.
- Strictly adhere to all installation instructions.

Failure to comply with these instructions could result in death or serious injury.

⚠ WARNING MISUSE OF DOCUMENTATION

- The information presented in this product sheet is for reference only. Do not use this document as a product installation guide.
- Complete installation, operation, and maintenance information is provided in the instructions supplied with each product.

Failure to comply with these instructions could result in death or serious injury.