

DESCRIPTION

The Honeywell HPM Series Particulate Matter Sensor is a laser-based sensor which detects and counts particles using light scattering. The detection concentration range is $0 \mu\text{g}/\text{m}^3$ to $1,000 \mu\text{g}/\text{m}^3$. A laser light source illuminates a particle as it is pulled through the detection chamber. As particles pass through the laser beam, the light reflects off the particles and is recorded on the photo or light detector. The light is then analyzed and converted to an electrical signal to calculate particle concentration. The Honeywell particle sensor provides information on the particle concentration for given particle concentration range.

VALUE TO CUSTOMERS

- Enables the ability to more accurately and cost-competitively monitor or control environmental particulate
- Industry-leading long life of 10 years of continuous use
- Proven EMC performance enables the ability to perform more accurately in a variety of tough industrial environments
- Faster response time of <6 s allows the HPM Series to respond to environmental conditions in real time
- Enhanced reliability allows for use in harsh environments

FEATURES

- Laser-based light scattering particle sensing
- Concentration range: $0 \mu\text{g}/\text{m}^3$ to $1,000 \mu\text{g}/\text{m}^3$
- Fully calibrated
- EMC: Heavy industrial level IEC61000
- Response time: <6 s
- Supply current: 80 mA max.
- Output signal: UART (Universal Asynchronous Receiver/Transmitter)
- PM2.5, PM10 output (standard); PM1.0, PM2.5, PM4.0, PM10 output (compact)
- RoHS compliant
- REACH compliant

DIFFERENTIATION

- Long life of 10 years offers a more stable operation for continuous usage
- Proven EMC performance, based on IEC61000 stable operation, $\pm 15\%$ accuracy (PM2.5)



POTENTIAL APPLICATIONS

- HVAC (commercial and residential)
- Indoor air quality monitors
- Handheld air quality monitors
- Air purifiers (commercial and residential)
- Automotive cabin air purifiers

Particulate Matter Sensors

HPM Series

Table 1. Specifications

	Standard HPMA115S0-XXX	Compact HPMA115C0-003 HPMA115C0-004
Characteristic		
Operating principle	laser scattering	
Detection^{1,2}	PM2.5, PM10	PM1.0, PM2.5, PM4.0, PM10
Output data^{1,2}	PM2.5 in $\mu\text{g}/\text{m}^3$, PM10 in $\mu\text{g}/\text{m}^3$	PM1.0 in $\mu\text{g}/\text{m}^3$, PM2.5 in $\mu\text{g}/\text{m}^3$, PM4.0 in $\mu\text{g}/\text{m}^3$, PM10 in $\mu\text{g}/\text{m}^3$
Concentration range	0 $\mu\text{g}/\text{m}^3$ to 1,000 $\mu\text{g}/\text{m}^3$	
Accuracy (at 25°C ±5°C): 0 $\mu\text{g}/\text{m}^3$ to 100 $\mu\text{g}/\text{m}^3$ 100 $\mu\text{g}/\text{m}^3$ to 1000 $\mu\text{g}/\text{m}^3$	PM2.5: ±15 $\mu\text{g}/\text{m}^3$ PM2.5: ±15 %	PM2.5: ±15 $\mu\text{g}/\text{m}^3$; PM1.0, PM4.0, PM10: ±25 $\mu\text{g}/\text{m}^3$ PM2.5: ±15 %; PM1.0, PM4.0, PM10: ±25%
Response time	<6 s	
Supply voltage³	5 V ±0.2 V	
Switching frequency max.	100 kHz	
Ripple amplitude max.	20 mV	
R.M.S noise max.	1 mV (noise bandwidth 10 MHz)	
Standby current (at 25°C ±5°C)	<20 mA	
Supply current (at 25°C ±5°C)	<80 mA	
Inrush current max. (at 25°C ±5°C)	600 mA	
Temperature: operating storage	-20°C to 50°C [-4°F to 122°F] -30°C to 65°C [-22°F to 149°F]	-20°C to 70°C [-4°F to 158°F] -40°C to 85°C [-40°F to 185°F]
Humidity (operating and storage)	0 %RH to 95 %RH non-condensing	
Output protocol⁴	UART; baud rate: 9600, databits: 8, stopbits: 1, parity: no	
Operating time: continuous mode intermittent mode	10 years depends on duty cycle	
Laser class	Laser Class 1: IEC/EN 60825-1: 650 nm	
ESD	±4 kV contact, ±8 kV air per IEC 61000-4-2	
Radiated immunity	1 V/m (80 MHz to 1000 MHz) per IEC 61000-4-3	
Fast transient burst	±0.5 kV per IEC61000-4-4	
Immunity to conducted disturbances radiated emissions	3 V per IEC61000-4-6	
Radiated emissions	40 dB 30 MHz to 230 MHz; 47 dB 230 MHz to 1000 MHz per CISPR 14	
Conducted emissions	0.15 MHz to 30 MHz in compliance with CISPR 14	
Dimensions (L X W X H)	43 mm x 36,00 mm x 23,7 mm [1.69 in x 1.42 in x 0.93 in]	44 mm x 36 mm x 12 mm [1.73 in x 1.42 in x 0.48 in]

¹ PM2.5 is particulate matter $\leq 2.5 \mu\text{m}$ in diameter; PM10 is particulate matter $\leq 10 \mu\text{m}$ in diameter.

² PM1.0 in $\mu\text{g}/\text{m}^3$, PM4.0 in $\mu\text{g}/\text{m}^3$, and PM10 in $\mu\text{g}/\text{m}^3$ are calculated from PM 2.5 readings.

³ Power supply output should contain one de-coupling capacitor (22 μF), and two ceramic capacitors (100 nF, 10 nF), if ripple amplitude max. or R.M.S. noise max. exceeds specifications.

⁴ Contact Honeywell for other output options.

**CLASS 1
LASER PRODUCT**

Table 2. Order Guide

Catalog Listing	Description
HPMA115S0-XXX	HPM Series PM2.5 Particulate Matter Sensor, standard size, UART output
HPMA115C0-003	HPM Series PM2.5 Particulate Matter Sensor, compact size, UART output, air inlet and air outlet on same side
HPMA115C0-004	HPM Series PM2.5 Particulate Matter Sensor, compact size, UART output, air inlet and air outlet on opposite sides

Particulate Matter Sensors

HPM Series

Figure 1. HPM Series Operation (standard version shown top down)

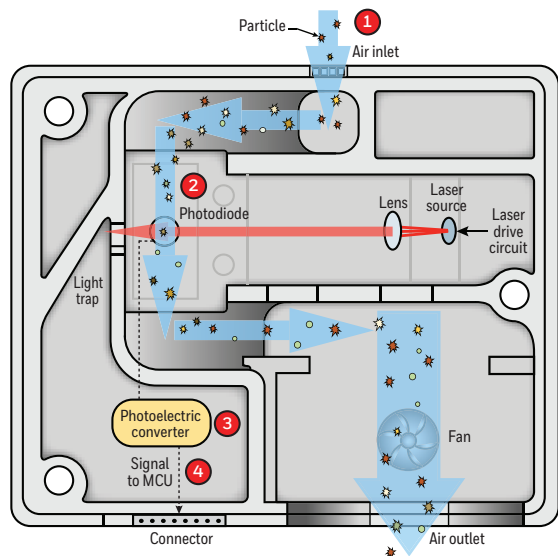

- 1 Fan draws in air through inlet.
- 2 Air passes through the laser where the light reflected off the particles is captured by the photodiode.
- 3 The photodiode passes information to the photoelectric converter. The photoelectric converter processes the signal from the particles into density.
- 4 Signal is transmitted to micro control unit where a proprietary algorithm processes the data and supplies outputs for the density of the particulate ($\mu\text{g}/\text{m}^3$).

Table 3. Standard and Compact Connector Pinout

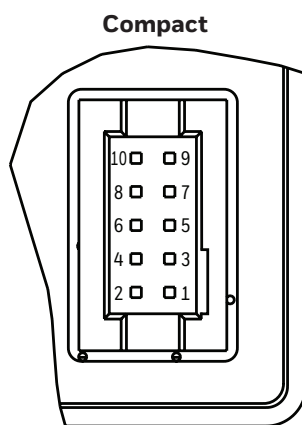
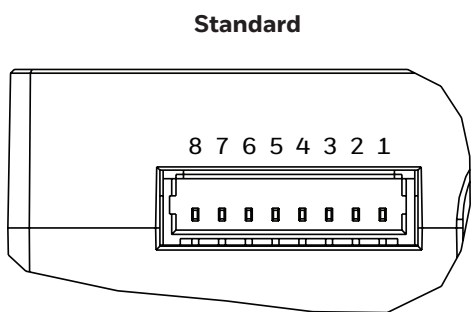

Pin	Name	Description	Pin	Name	Description
1	V _{OUT}	power output (+3.3 V/100 mA)	1	V _{OUT}	power output (+5 V) (output max.: 300 mA)
2	V _{CC}	power input (5 V)	2	V _{CC}	power input (+5 V)
3	N/A	N/A	3	GND	ground
4	N/A	N/A	4	GND	ground
5	RES	reserved for future use	5	RES	reserved for future use
6	TX	UART TX output (0 V - 3.3 V)	6	N/A	N/A
7	RX	UART RX input (0 V - 3.3 V)	7	RX	UART RX input (0 V - 3.3 V)
8	GND	ground	8	N/A	N/A
-	—	—	9	TX	UART TX output (0 V - 3.3 V)
-	—	—	10	SET	reserved for future use

Particulate Matter Sensors

HPM Series

Table 4. Standard Version Customer Use Protocol¹

Command Length (Bytes)	HEAD	LEN	CMD	Data	CS	Example
Read Particle Measuring Results						
Send	0x68	0x01	0x04	NA	CS = MOD ((65536-(HEAD+LEN+CMD+DATA)), 256)	68 01 04 93
Response, Pos ACK	0x40	0x05	0x04	“DF1, DF2, DF3, DF4 PM2.5 = DF1 * 256 + DF2 PM10 = DF3 * 256 + DF4”	CS = MOD ((65536-(HEAD+LEN+CMD+DATA)), 256)	40 05 04 00 30 00 31 56
Response, Neg ACK						0x9696
Start Particle Measurement						
Send	0x68	0x01	0x01	NA	CS = MOD ((65536-(HEAD+LEN+CMD+DATA)), 256)	68 01 01 96
Response, Pos ACK						0xA5A5
Response, Neg ACK						0x9696
Stop Particle Measurement²						
Send	0x68	0x01	0x02	NA	CS = MOD ((65536-(HEAD+LEN+CMD+DATA)), 256)	68 01 02 95
Response, Pos ACK						0xA5A5
Response, Neg ACK						0x9696
Set Customer Adjustment Coefficient						
Send	0x68	0x02	0x08	DF1: 30 ~ 200 (Default, 100)	CS = MOD ((65536-(HEAD+LEN+CMD+DATA)), 256)	68 02 08 64 2A
Response, Pos ACK						0xA5A5
Response, Neg ACK						0x9696
Read Customer Adjustment Coefficient						
Send	0x68	0x01	0x10	NA	CS = MOD ((65536-(HEAD+LEN+CMD+DATA)), 256)	68 01 10 87
Response, Pos ACK	0x40	0x02	0x10	DF1: 30 ~ 200 (Default, 100)	CS = MOD ((65536-(HEAD+LEN+CMD+DATA)), 256)	40 02 10 64 4A
Response, Neg ACK						0x9696
Stop Auto Send						
Send	0x68	0x01	0x20	NA	CS = MOD ((65536-(HEAD+LEN+CMD+DATA)), 256)	68 01 20 77
Response, Pos ACK						0xA5A5
Response, Neg ACK						0x9696
Enable Auto Send³						
Send	0x68	0x01	0x40	NA	CS = MOD ((65536-(HEAD+LEN+CMD+DATA)), 256)	68 01 40 57
Response, Pos ACK						0xA5A5
Response, Neg ACK						0x9696

¹Product life may vary depending on the specific application in which the sensor is utilized.

²Shuts down the fan, helping to extend the life of the product.

³See Table 6 for data format.

Particulate Matter Sensors

HPM Series

Table 5. Standard Version Data Format (Protocol Length: 32 Bytes)

Byte Number	Head0	Head0	Head0
Byte0	Head0	0x42	fixed
Byte1	Head1	0x4d	
Byte2	Len_H	...	Frame Length = $2 \times 13 + 2(\text{data length} + \text{checksum length})$
Byte3	Len_L	...	
Byte4	Data0_H	...	reserve
Byte5	Data0_L	...	
Byte6	Data1_H	...	PM2.5 concentration (standard particulate matter)
Byte7	Data1_L	...	
Byte8	Data2_H	...	PM10 concentration (standard particulate matter)
Byte9	Data2_L	...	
Byte10	Data3_H	...	reserve
Byte11	Data3_L	...	
Byte12	Data4_H	...	reserve
Byte13	Data4_L	...	
Byte14	Data5_H	...	reserve
Byte15	Data5_L	...	
Byte16	Data6_H	...	reserve
Byte17	Data6_L	...	
Byte18	Data7_H	...	reserve
Byte19	Data7_L	...	
Byte20	Data8_H	...	reserve
Byte21	Data8_L	...	
Byte22	Data9_H	...	reserve
Byte23	Data9_L	...	
Byte24	Data10_H	...	reserve
Byte25	Data10_L	...	
Byte26	Data11_H	...	reserve
Byte27	Data11_L	...	
Byte28	Data12_H	...	reserve
Byte29	Data12_L	...	
Byte30	CheckSum_H	...	Checksum = Head0+Head1+Len_H+Len_L+Data0_H+...+Data12_L
Byte31	CheckSum_L	...	

Particulate Matter Sensors

HPM Series

Table 6. Compact Version Customer Use Protocol¹

Command Length (Bytes)	HEAD	LEN	CMD	Data	CS	Example
Read Particle Measuring Results						
Send	0x68	0x01	0x04	NA	CS = MOD (((65536-(HEAD+LEN+CMD+DATA)), 256)	68 01 04 93
Response, Pos ACK	0x40	0x05	0x04	DF1-DF8, DF9~ DF12 reserved PM1.0 = DF1 * 256 + DF2 PM2.5 = DF3 * 256 + DF4 PM4.0 = DF5 * 256 + DF6 PM10 = DF7 * 256 + DF8	CS = MOD (((65536-(HEAD+LEN+CMD+DATA)), 256)	40 0D 04 00 30 00 31 00 32 00 33 00 00 00 00 E9
Response, Neg ACK	0x9696					
Start Particle Measurement						
Send	0x68	0x01	0x01	NA	CS = MOD (((65536-(HEAD+LEN+CMD+DATA)), 256)	68 01 01 96
Response, Pos ACK	0xA5A5					
Response, Neg ACK	0x9696					
Stop Particle Measurement²						
Send	0x68	0x01	0x02	NA	CS = MOD (((65536-(HEAD+LEN+CMD+DATA)), 256)	68 01 02 95
Response, Pos ACK	0xA5A5					
Response, Neg ACK	0x9696					
Set Customer Adjustment Coefficient						
Send	0x68	0x02	0x08	DF1: 30 ~ 200 (Default, 100)	CS = MOD (((65536-(HEAD+LEN+CMD+DATA)), 256)	68 02 08 64 2A
Response, Pos ACK	0xA5A5					
Response, Neg ACK	0x9696					
Read Customer Adjustment Coefficient						
Send	0x68	0x01	0x10	NA	CS = MOD (((65536-(HEAD+LEN+CMD+DATA)), 256)	68 01 10 87
Response, Pos ACK	0x40	0x02	0x10	DF1: 30 ~ 200 (Default, 100)	CS = MOD (((65536-(HEAD+LEN+CMD+DATA)), 256)	40 02 10 64 4A
Response, Neg ACK	0x9696					
Stop Auto Send						
Send	0x68	0x01	0x20	NA	CS = MOD (((65536-(HEAD+LEN+CMD+DATA)), 256)	68 01 20 77
Response, Pos ACK	0xA5A5					
Response, Neg ACK	0x9696					
Enable Auto Send³						
Send	0x68	0x01	0x40	NA	CS = MOD (((65536-(HEAD+LEN+CMD+DATA)), 256)	68 01 40 57
Response, Pos ACK	0xA5A5					
Response, Neg ACK	0x9696					

¹Product life may vary depending on the specific application in which the sensor is utilized.

²Shuts down the fan, helping to extend the life of the product.

³See Table 7 for data format.

Particulate Matter Sensors

HPM Series

Table 7. Compact Version Data Format (Protocol Length: 32 Bytes)

Byte Number	Head0	Head0	Head0
Byte0	Head0	0x42	fixed
Byte1	Head1	0x4d	
Byte2	Len_H	...	Frame Length = 2x13+2(data length + checksum length)
Byte3	Len_L	...	
Byte4	Data0_H	...	PM1.0 concentration (standard particulate matter)
Byte5	Data0_L	...	
Byte6	Data1_H	...	PM2.5 concentration (standard particulate matter)
Byte7	Data1_L	...	
Byte8	Data2_H	...	PM4.0 concentration (standard particulate matter)
Byte9	Data2_L	...	
Byte10	Data3_H	...	PM10 concentration (standard particulate matter)
Byte11	Data3_L	...	
Byte12	Data4_H	...	reserve
Byte13	Data4_L	...	
Byte14	Data5_H	...	reserve
Byte15	Data5_L	...	
Byte16	Data6_H	...	reserve
Byte17	Data6_L	...	
Byte18	Data7_H	...	reserve
Byte19	Data7_L	...	
Byte20	Data8_H	...	reserve
Byte21	Data8_L	...	
Byte22	Data9_H	...	reserve
Byte23	Data9_L	...	
Byte24	Data10_H	...	reserve
Byte25	Data10_L	...	
Byte26	Data11_H	...	reserve
Byte27	Data11_L	...	
Byte28	Data12_H	...	reserve
Byte29	Data12_L	...	
Byte30	CheckSum_H	...	Checksum = Head0+Head1+Len_H+Len_L+Data0_
Byte31	CheckSum_L	...	H+...+Data12_L

Particulate Matter Sensors

HPM Series

CAUTION

PRODUCT DAMAGE

Ensure adherence to all installation instructions.

Failure to comply with these instructions could result in product damage.

NOTICE

IMPROPER INSTALLATION

To avoid particulate settling or accumulation at the air outlet or air inlet, which may affect product sensitivity and accuracy, ensure that the HPM Series Particle Sensor:

- Is installed correctly according to Figure 2, 3, or 4.
- Is installed such that the air inlet and air outlets are not blocked and that the flow of air through the sensor is neither reduced nor increased.

Product Installation

Install the product to the desired surface using the screw size shown in the applicable figure.

Figure 2. Standard Mounting Dimensions and Correct Installation Orientations (For reference only. (mm/[in])

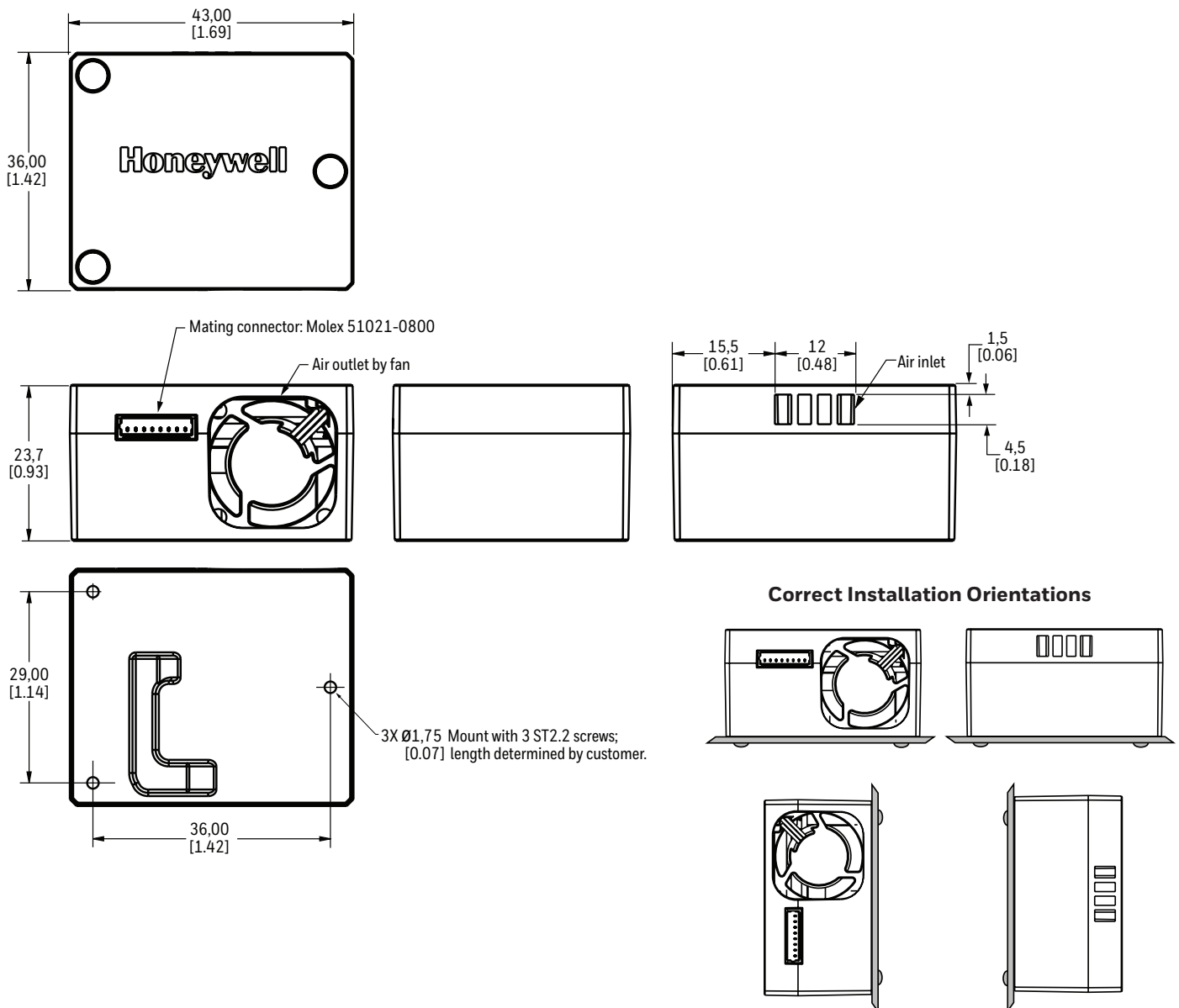

Particulate Matter Sensors

HPM Series

Figure 3. Compact Version HPM115CO-003 Mounting Dimensions and Correct Installation Orientations
 (For reference only: mm/[in])

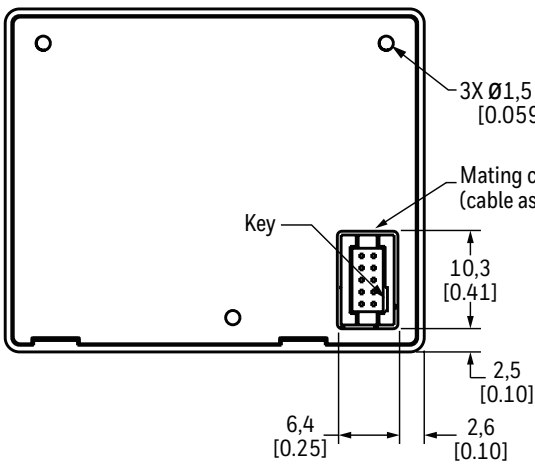
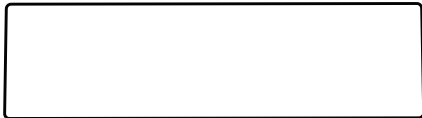
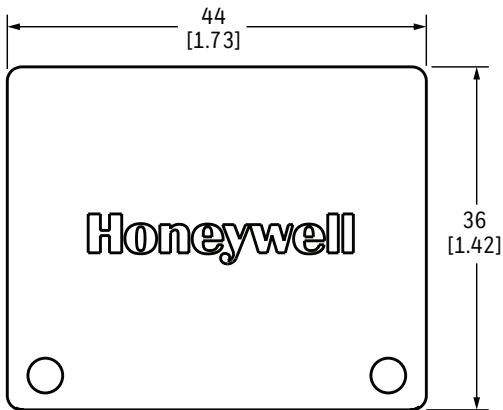
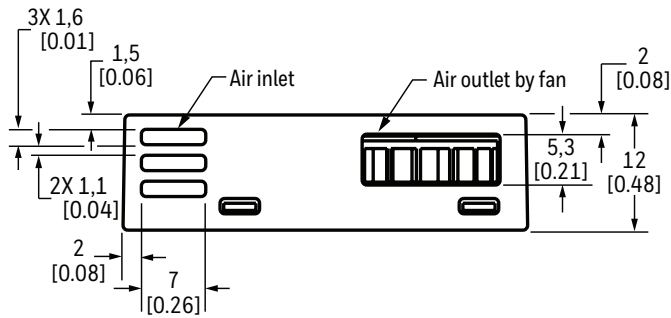

Correct Installation Orientations

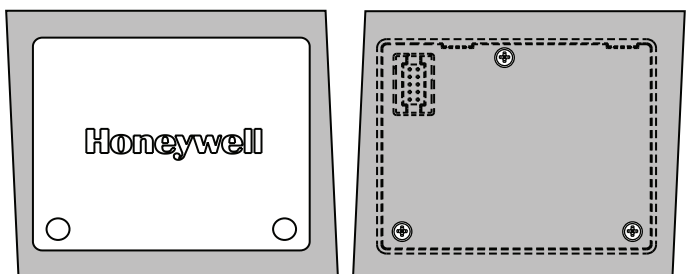
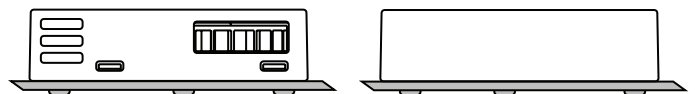

Particulate Matter Sensors

HPM Series

Figure 4. Compact Version HPMA115CO-004 Mounting Dimensions and Correct Installation Orientations
(For reference only: mm/[in])

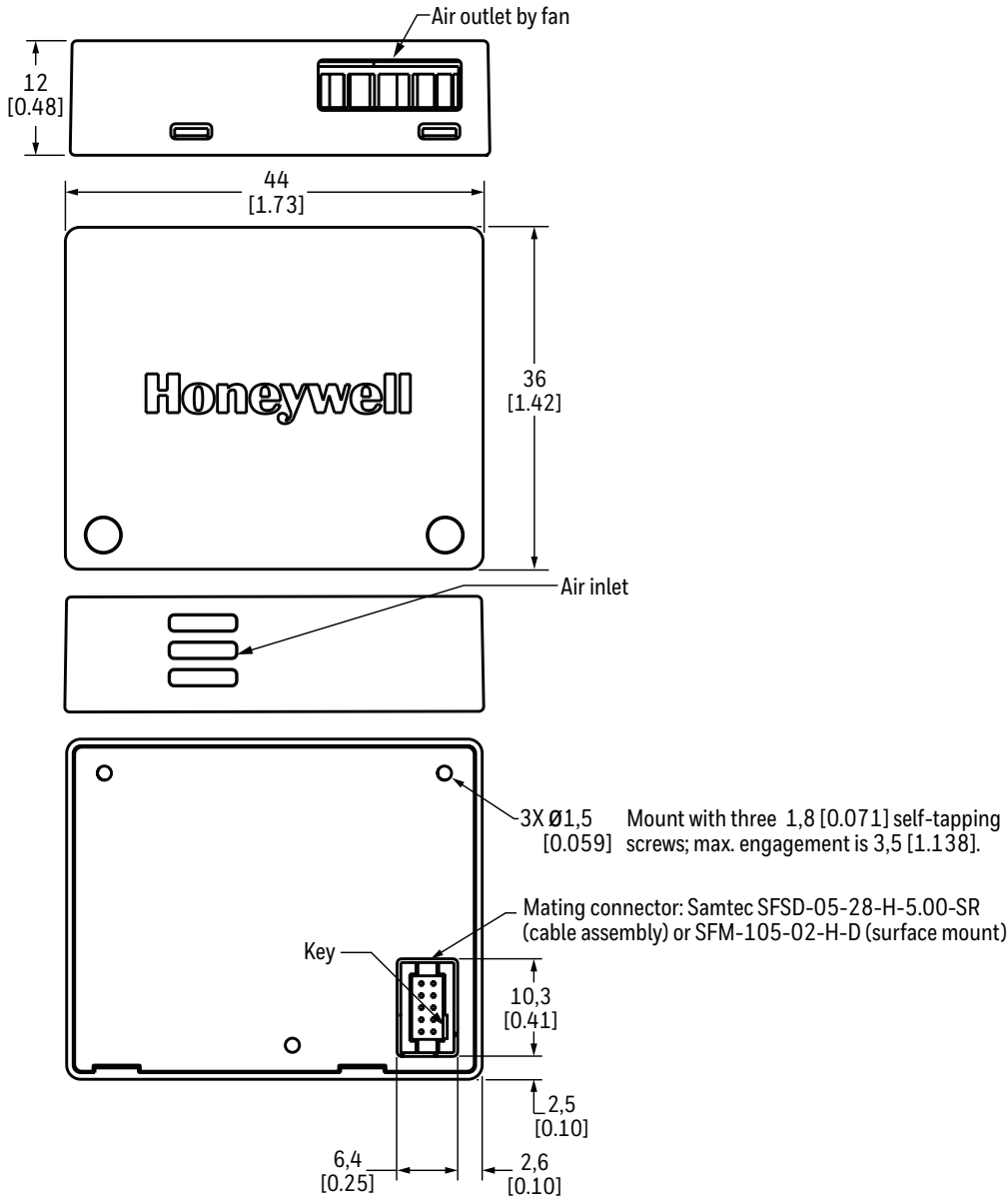

Correct Installation Orientations

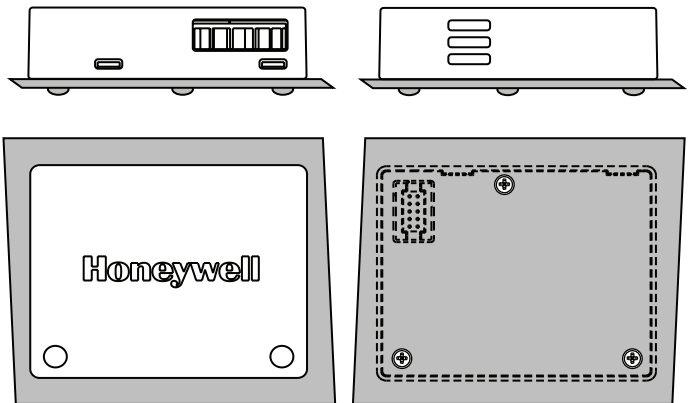

ADDITIONAL INFORMATION

The following associated literature is available on the Honeywell web site at sensing.honeywell.com:

- Sell sheet
- Frequently Asked Questions (FAQs)

⚠ WARNING PERSONAL INJURY

DO NOT USE these products as safety or emergency stop devices or in any other application where failure of the product could result in personal injury.

Failure to comply with these instructions could result in death or serious injury.

Warranty/Remedy

Honeywell warrants goods of its manufacture as being free of defective materials and faulty workmanship during the applicable warranty period. Honeywell's standard product warranty applies unless agreed to otherwise by Honeywell in writing; please refer to your order acknowledgment or consult your local sales office for specific warranty details. If warranted goods are returned to Honeywell during the period of coverage, Honeywell will repair or replace, at its option, without charge those items that Honeywell, in its sole discretion, finds defective. **The foregoing is buyer's sole remedy and is in lieu of all other warranties, expressed or implied, including those of merchantability and fitness for a particular purpose. In no event shall Honeywell be liable for consequential, special, or indirect damages.**

While Honeywell may provide application assistance personally, through our literature and the Honeywell web site, it is buyer's sole responsibility to determine the suitability of the product in the application.

Specifications may change without notice. The information we supply is believed to be accurate and reliable as of this writing. However, Honeywell assumes no responsibility for its use.

For more information

Honeywell Advanced Sensing Technologies services its customers through a worldwide network of sales offices and distributors. For application assistance, current specifications, pricing or the nearest Authorized Distributor, visit [our website](#) or call:

Asia Pacific +65 6355-2828
Europe +44 (0) 1698 481481
USA/Canada +1-800-537-6945

Honeywell

Advanced Sensing Technologies

830 East Arapaho Road
Richardson, TX 75081
sps.honeywell.com/ast