

Liquid Level Height Sensing Using Selected Honeywell Board Mount Pressure Sensors: MPR, ABP, and TBP Series

A Technical Note

1.0 INTRODUCTION

This technical note demonstrates how to calculate the liquid level height in an unpressurized or pressurized container by using a board mounted pressure sensor to measure the hydrostatic pressure.

2.0 EQUATIONS AND CONSTANTS

The full equation for pressure liquid level height versus pressure is:

$$\text{Liquid Level Height} = \text{Pressure Exerted} / (\text{Density} * \text{Gravitational Constant})$$

However, for most applications at lower altitudes the simplified equation may be used:

$$\text{Liquid Level Height} = \text{Pressure} / \text{Specific Gravity, or } H = P / SG$$

where:

H = Height, in inches, of the liquid being measured

P = Pressure, in inches of water (inH₂O), of the liquid being measured

SG = Specific gravity constant of the liquid being measured (See Table 1.)

Table 1: Approximate Specific Gravity Constants of Common Liquids¹

Liquid	Specific Gravity Constant
Water at 4°C	1.00
Water at 20°C	0.998
Ethyl alcohol at 20°C	0.789
Isopropyl alcohol at 20°C	0.785
Seawater at 25°C	1.028

¹ Specific gravity changes over temperature.

3.0 FINDING LIQUID LEVEL HEIGHT

3.1 Using an unpressurized container

Using the equation $H = P/SG$, the two examples in Figure 1 show how different media at different pressures may have the same liquid level height. The pressure sensor shown is Honeywell's ABP Series, enhanced accuracy, digital or analog output, compensated/amplified, basic board mount pressure sensor. The MPR Series is an I²C or SPI digital output sensor.

Figure 1. Two Examples of Finding Liquid Level Height Using an Unpressurized Container

Example 1: Water at 4°C	Example 2: Ethyl alcohol at 20°C
H = 8.5 inH ₂ O/1.00	H = 6.7 inH ₂ O/0.789
H = 8.5 in	H = 8.5 in

Example 1:

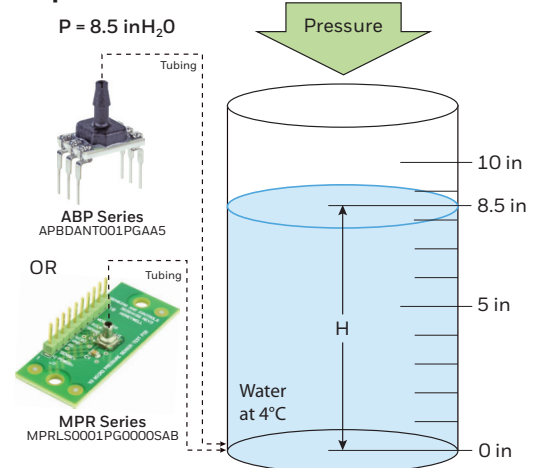

Example 2:

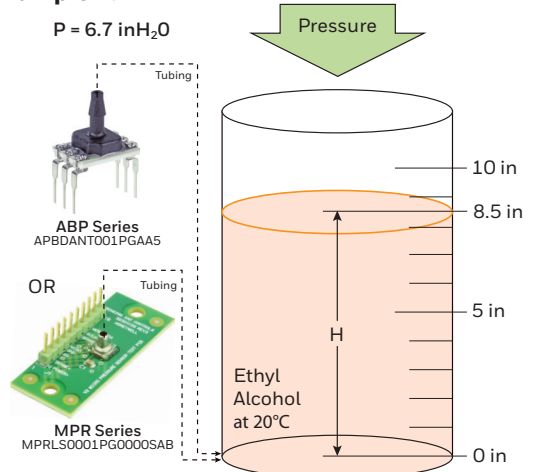

3.2 Using a pressurized container

Instead of using a single ported sensor, as was used in measuring the liquid level height in an unpressurized container, the pressure sensor used here needs to be a dual ported, liquid media compatible (wet/wet) device.

The sensor is mounted at the bottom of the container. This positioning gives a liquid-coupled measurement. Although a small air bubble may be present due to trapped air between the container and sensor, this method, for the most part, directly measures the pressure which indicates the height of the liquid.

Example: What is the liquid level height of a container where $P_1 = 9.0 \text{ inH}_2\text{O}$, $P_2 = 0.5 \text{ inH}_2\text{O}$, and the liquid is water at 4°C ?

Using the difference between P_1 and P_2 as P , the equation in Section 2.0 becomes: $H = (P_1 - P_2)/SG$:

$$H = (9.0 \text{ inH}_2\text{O} - 0.5 \text{ inH}_2\text{O})/1.00$$

$$H = 8.5 \text{ in}$$

Figure 2. Pressurized Container

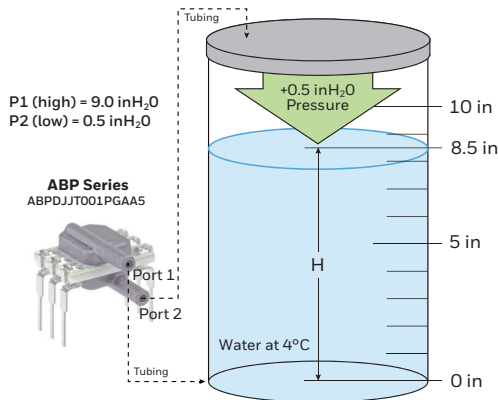

Due to the relative unavailability of dual ported sensors tolerant of liquid media on both ports, two single ported gage or absolute pressure sensors have traditionally been used in this situation. This method not only carries the cost penalty of having to buy two sensors instead of one but may also double the measurement error. For this reason, ABP Series and TBP Series differential sensors are preferred.

4.0 SOLVING FOR SENSOR PRESSURE RANGE WHEN THE CONTAINER HEIGHT IS KNOWN

Example: What is the required pressure range of a sensor if the maximum height of the container is 25 inches, and the liquid is water at 4°C ?

Solving for P , the equation in Section 2.0 becomes: $P = H \times SG$:

$$P = 25 \text{ in} \times 1.00$$

$$P = 25 \text{ inH}_2\text{O}$$

A 25 inH₂O full scale pressure sensor is used (1 psi ≈ 27.7 inH₂O at 4°C), such as the ABP Series liquid media capable sensor ABPANT001PGAA5 or MPR Series MPRLS0001PG0000SAB as shown in Figure 3.

The ABPANT001PGAA5 sensor provides an analog output proportional to the applied pressure in the container, from 0.5 Vdc (no pressure applied) and 4.5 Vdc (1 psi applied). In this example, the MPRLS0001PG0000SAB sensor provides an SPI digital output proportional to the applied pressure of approximately 9430370 counts at 16 inches of water from the 24 bit ASIC when the water level is at 16 in.

Figure 3. Known Container Height

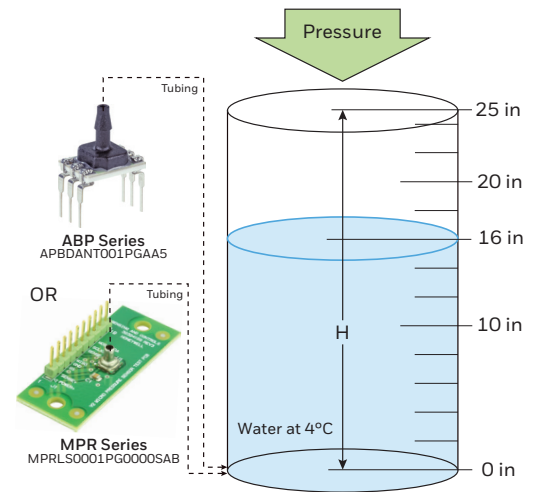

5.0 REMOTE OR TOP MOUNTING

This method, as shown in Figure 4, allows the sensor to be remotely mounted using tubing to make the connection between the bottom of the container and the sensor. A single piece of tubing, or a piece of tubing connected to a tube, is used to run from the bottom of the container to the sensor.

The advantage of this method is that the media has an air column between it and the pressure sensor, helping to isolate the sensor from harsh media. A possible concern is that if the tubing interface or sensor has even a small amount of mechanical leakage, it can have a significant impact on accuracy, which shows up as drift over time of the measurement.

Figure 4 . Remote or Top Mounting

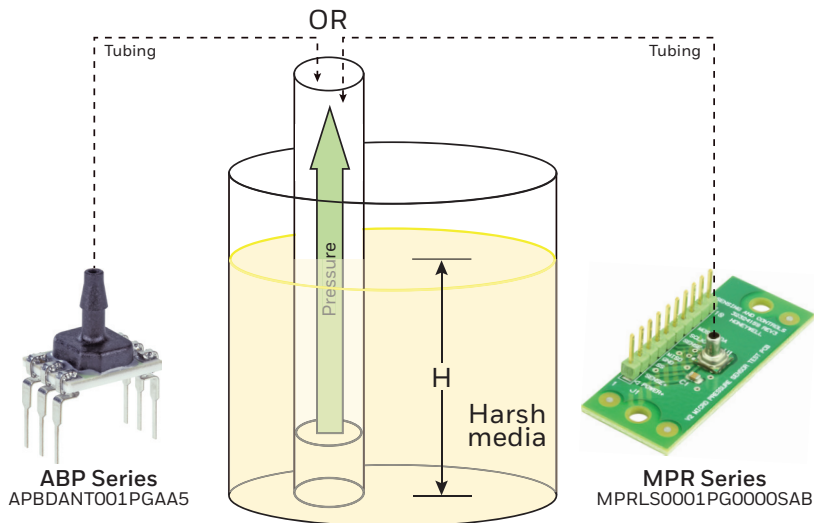

Example: What is required value of R_g if $P = 27.8$ inH₂O maximum, the sensor used is 1 psi, and the liquid is water at 4°C?

Equations used:
 $R_g = 100000 / (\text{Gain} - 1)$
 $\text{Gain} = \text{Span} / \text{Signal}$

To account for part-to-part sensor and amplifier offset variation, use a 100 kOhm potentiometer to calibrate V_{out} :

$V_{out} = 0.5 \text{ Vdc}$ (no pressure applied)

Resulting amplifier output:

P at 0 inH₂O = 0.5 Vdc
P at 27.8 inH₂O = 4.5 Vdc
Span = 4.5 Vdc - 0.5 Vdc
Span = 4 Vdc

6.0 USING A TBP SERIES UNAMPLIFIED SENSOR

A TBP Series, compensated/unamplified basic board mount pressure sensor with the liquid media option, may be used to measure liquids that are compatible with silicone. Figure 5 shows an example circuit that may be used to amplify the output.

Figure 5. Example Output Amplification Circuit

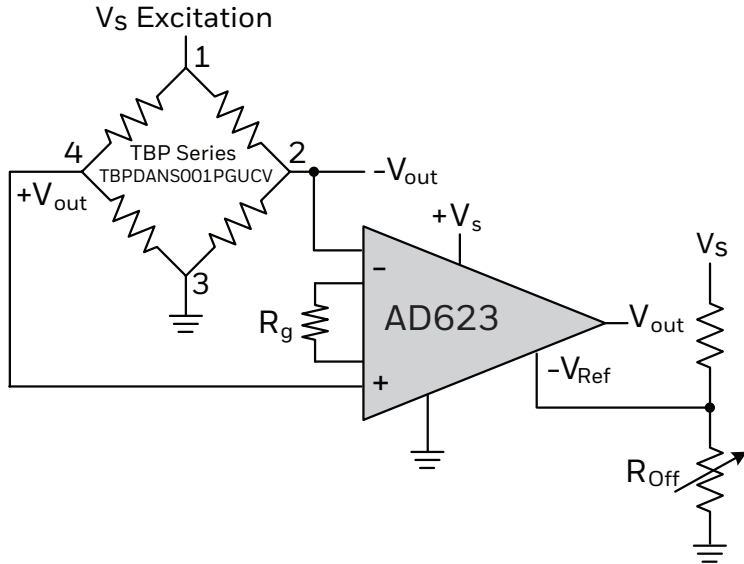

TBPDANS001PGUCV full scale output = 1.5 mV/V, or 7.5 mV when using a 5 Vdc supply

Gain = 4 Vdc / 0.0075 Vdc
Gain = 533

$R_g = 100000 \text{ Ohm} / (533 - 1)$
 $R_g = 100000 \text{ Ohm} / 532$
 $R_g = 188.0 \text{ Ohm}$

7.0 EVALUATION TOOLS

7.1 SEK002 Sensor Evaluation Kit (See Figure 6)

The MPR Series and digital versions of the ABP Series may be used in conjunction with the SEK002 Evaluation Kit (purchased from Honeywell authorized distributors). The SEK002 allows the user to obtain sensor readings without needing to develop any code.

The SEK002 is plugged in as a shield board to an Arduino™ Uno Rev3 Microcontroller Board. Honeywell evaluation software, downloaded to the user's PC, controls the Arduino Uno Rev3 to take sensor readings that are then displayed on the PC's screen.

Figure 6. SEK002 Sensor Evaluation Kit (Shown with ABP Series Sensor and Arduino™ Uno Rev3)

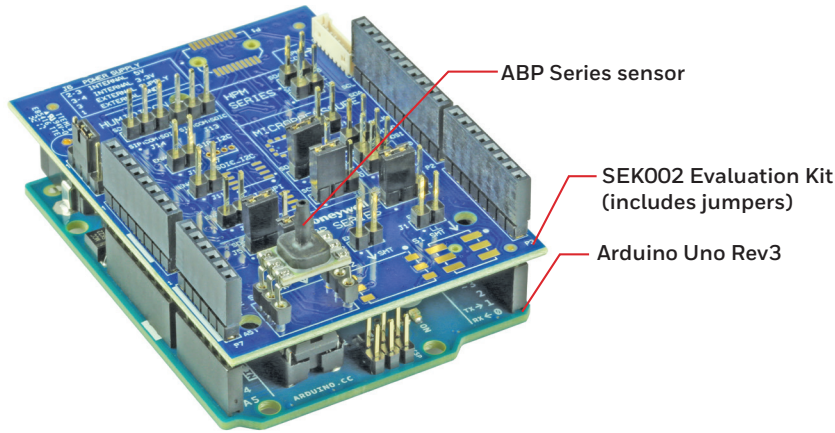

7.2 MPR Series sensor on breakout board (See Figure 7)

Selected MPR Series sensors (catalog listing contains a “B” suffix) are available mounted on a breakout board which allows easier connection to the SEK002 Sensor Evaluation Kit.

Figure 7 . MPR Series Breakout Board

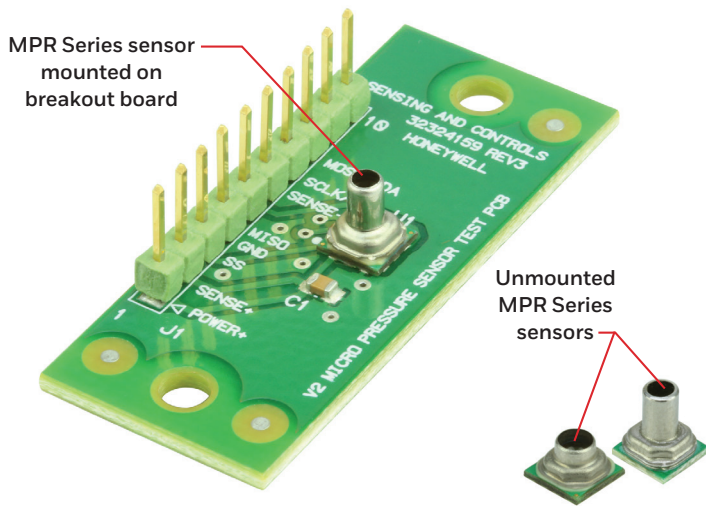

For more information

Honeywell Sensing and Internet of Things services its customers through a worldwide network of sales offices and distributors. For application assistance, current specifications, pricing or the nearest Authorized Distributor, visit sensing.honeywell.com or call:

- Asia Pacific +65 6355-2828
- Europe +44 (0) 1698 481481
- USA/Canada +1-800-537-6945

Arduino is a trademark or registered trademark of Arduino, LLC in the United States and/or other countries.

Honeywell Sensing and Internet of Things

9680 Old Bailes Road
 Fort Mill, SC 29707
www.honeywell.com

008317-2-EN | 2 | 01/18
 © 2018 Honeywell International Inc.

Warranty/Remedy

Honeywell warrants goods of its manufacture as being free of defective materials and faulty workmanship during the applicable warranty period. Honeywell’s standard product warranty applies unless agreed to otherwise by Honeywell in writing; please refer to your order acknowledgment or consult your local sales office for specific warranty details. If warranted goods are returned to Honeywell during the period of coverage, Honeywell will repair or replace, at its option, without charge those items that Honeywell, in its sole discretion, finds defective.

The foregoing is buyer’s sole remedy and is in lieu of all other warranties, expressed or implied, including those of merchantability and fitness for a particular purpose. In no event shall Honeywell be liable for consequential, special, or indirect damages.

While Honeywell may provide application assistance personally, through our literature and the Honeywell web site, it is buyer’s sole responsibility to determine the suitability of the product in the application.

Specifications may change without notice. The information we supply is believed to be accurate and reliable as of this writing. However, Honeywell assumes no responsibility for its use.

