

User Instructions for the Sensor Evaluation Kit, SEK002, for Use with ABP Series (Digital Versions) and MPR Series Board Mount Pressure Sensors, Honeywell HumidCon™ Digital Humidity/Temperature Sensors, and HPM Series Particle Sensors

32333651
Issue A

1.0 OVERVIEW

The Sensor Evaluation Kit, SEK002, along with the readily-available components shown in Table 1, and the free evaluation software available on Honeywell's website, comprise a simple set of components used to evaluate the sensors listed in Table 2.

The SEK002 allows the user to obtain sensor readings without needing to develop any code. The SEK002 is plugged in as a shield board to the Arduino™ Uno Rev3 Microcontroller Board. Honeywell evaluation software, downloaded to the user's PC, controls the Arduino Uno Rev3 to take sensor readings that are then displayed on the PC's screen.





The readings may also be recorded to a .csv file for further analysis.

Sensors may be mounted directly on the SEK002 or remotely connected to the SEK002 via wire leads, allowing the sensor to be tested in adverse environments, or in a prototype product for proof of concept testing.

2.0 SEK002 AND USER-PROVIDED COMPONENTS

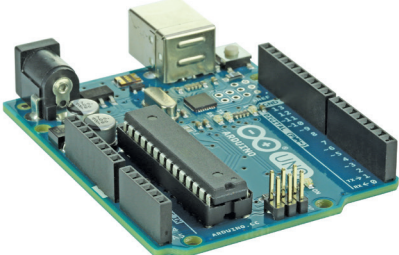
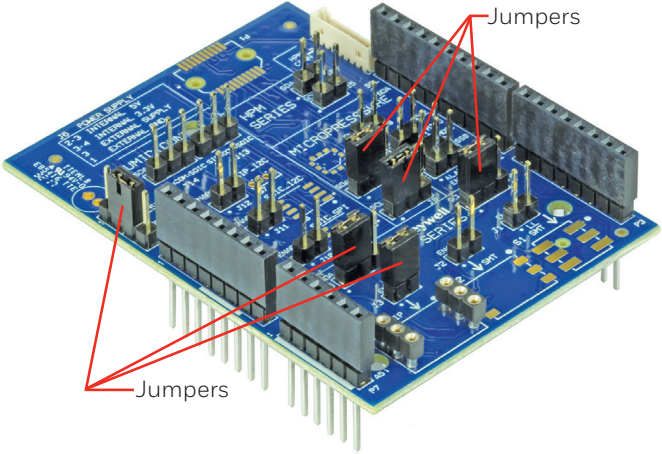
2.1 Assemble the components shown in Table 1.

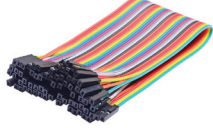
Table 1. Sensor Evaluation Kit Contents and User-Provided Items¹







Honeywell Sensor Evaluation Kit, SEK002	User-Provided Components	
<p>Includes:</p> <ul style="list-style-type: none"> • Sensor Evaluation Board • Jumpers for the ABP Series ABPDLNN100MG2A5 preconfigured on the board 	<p>Arduino Uno Rev3 Microcontroller Board (A000066)</p> 	
	<p>USB Interface Cable (Type A Male to Type B Male)</p> 	<p>Jumper Wires (for use with remote connections)</p> 
	<p>PC with Internet access (Note: If using a docking station computer, ensure that the computer is not in its docking station when installing and running the software.)</p> 	

¹The Honeywell sensor is not included with the SEK002. The user must purchase the sensor separately.

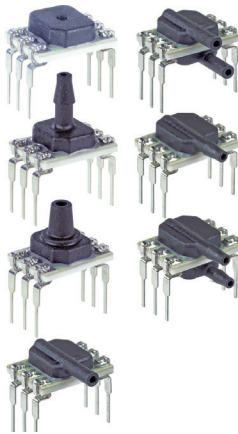
Sensor Evaluation Kit, SEK002

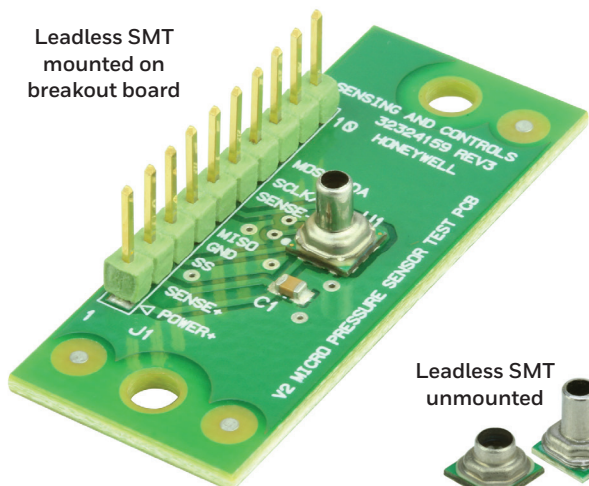
2.2 Choose the sensor to be evaluated. Click on the links to the specific series in Table 2 to access the product datasheets.

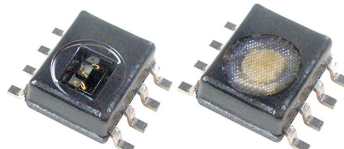
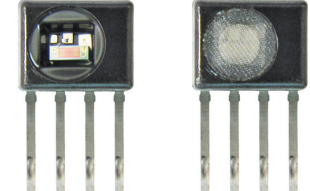
Table 2. SEK002 Compatible Sensors

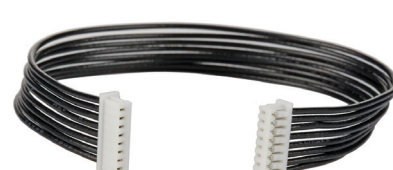
<p style="text-align: center;">Basic Board Mount Pressure Sensors ABP Series—High Accuracy, Compensated/Amplified</p> <p style="text-align: center;">Digital output versions only DIP, SMT, leadless SMT packages: SPI, I²C output</p> <div style="display: flex; justify-content: space-around;"> <div style="text-align: center;"> <p>DIP</p>  </div> <div style="text-align: center;"> <p>SMT</p>  </div> <div style="text-align: center;"> <p>Leadless SMT</p>  </div> </div> <p>Note: Refer to the product datasheet for soldering information.</p>	<p style="text-align: center;">MicroPressure Board Mount Pressure Sensors MPR Series—Compact High Accuracy, Compensated/Amplified</p> <p style="text-align: center;">Leadless SMT packages: SPI, I²C</p> <div style="text-align: center;"> <p>Leadless SMT mounted on breakout board</p>  </div> <div style="text-align: center;"> <p>Leadless SMT unmounted</p>  </div> <p>Note: See Appendix E for dimensions and more information on the breakout board. Refer to the MPR Series product datasheet for unmounted product soldering information.</p>
<p style="text-align: center;">Honeywell HumidIcon Digital Humidity/Temperature Sensors HIH6100 Series, HIH6000 Series, HIH7000 Series, HIH8000 Series, HIH9000 Series</p> <p style="text-align: center;">SOIC-8 packages: SPI, I²C output SIP packages: I²C output</p> <div style="display: flex; flex-direction: column;"> <div style="display: flex; justify-content: space-around;"> <div style="text-align: center;"> <p>SOIC-8</p>  </div> </div> <div style="display: flex; justify-content: space-around;"> <div style="text-align: center;"> <p>SIP</p>  </div> </div> </div> <p>Note: Refer to the product datasheet for soldering information.</p>	<p style="text-align: center;">Particle Sensors HPM Series</p> <p style="text-align: center;">UART output</p> <div style="text-align: center;">  </div> <p>Note: A specialized cable (32332297-001), shown below and available separately from Honeywell, is required for use with the HPM Series. Do not use cables from other manufacturers. See Appendix F for more information.</p> <div style="text-align: center;">  </div>

Sensor Evaluation Kit, SEK002

2.3 Connect the sensor to be evaluated to the SEK002

The SEK002 is preconfigured with jumpers in order to evaluate an ABP Series sensor, I²C, 5 Vdc. For the purposes of these User Instructions, the part number being evaluated is **ABPDLNN100MG2A5** (Note: For the other compatible sensors, see Appendix C for the jumper selections and configure the jumpers accordingly.)

Mount the **ABPDLNN100MG2A5** in the appropriate socket on the SEK002. The white dot on the socket indicates pin 1 of the sensor (see Figure 1). (Note: Only one sensor may be evaluated at a time.)

Figure 1. ABPDLNN100MG2A5 Mounted on the SEK002

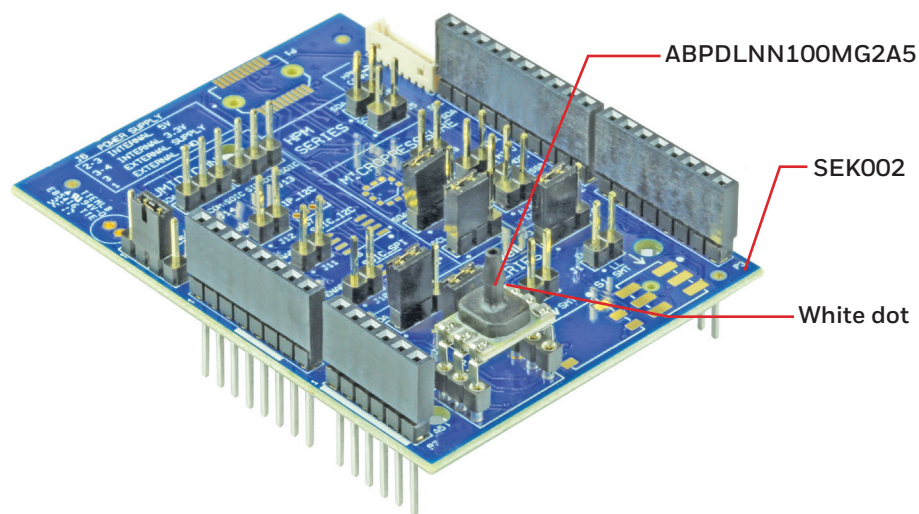

2.4 Connect the SEK002 to the Arduino Uno Rev3 to form the SEK002/Arduino Assembly

Place the SEK002 over the Arduino Uno Rev3 and align all pins and sockets. Gently, but firmly, press both boards together until the SEK002 is seated on top of the Arduino Uno Board (see Figure 2).

Figure 2. SEK002/Arduino Assembly

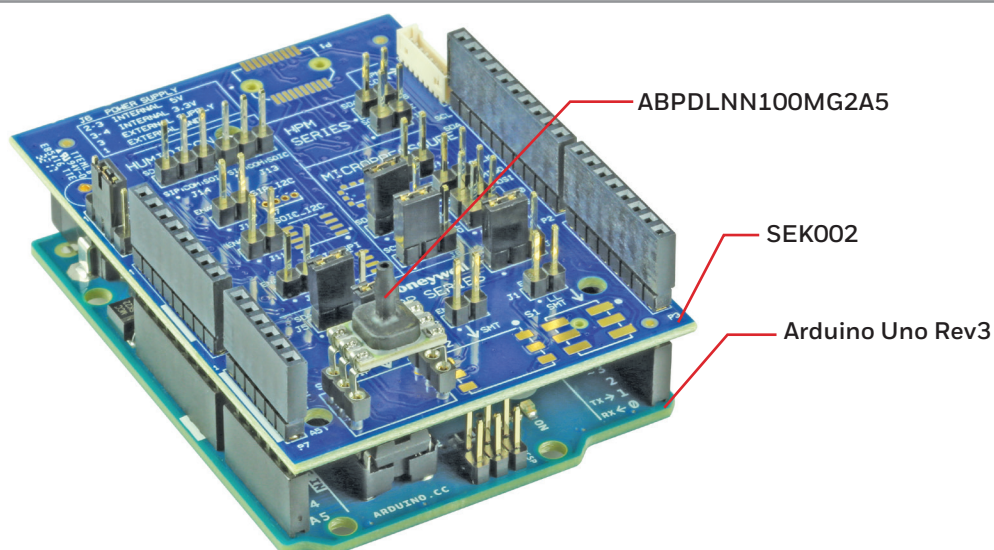

3.0 DOWNLOAD AND INSTALL SOFTWARE AND FIRMWARE

3.1 Follow the steps given in Table 3.

Table 3. Software and Firmware Download and Installation Process

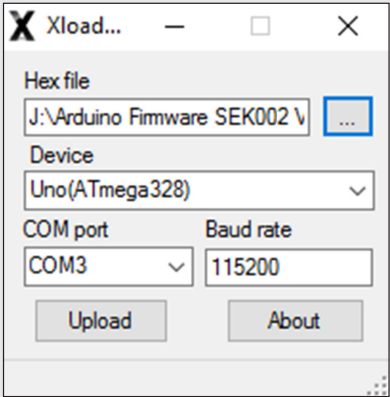
Step	Procedure	Notes and Troubleshooting
1	<p>Go to: http://sensing.honeywell.com/sensors/evaluation-kit and download the following three files to a location of your choice on your PC:</p> <ol style="list-style-type: none"> Sensor Evaluation Kit SEK002 Version 1.0.exe¹ Arduino Firmware SEK002 Version 1.0.hex¹ XLoader.zip 	<ol style="list-style-type: none"> Windows application that also contains Virtual COM Port (VCP) drivers. Arduino firmware needed to drive the SEK002. Contains XLoader.exe (a freeware) which is used to flash Arduino Firmware SEK002 Version 1.0.hex to the SEK002/Arduino Assembly (also available at http://xloader.russeotto.com, which is made available from a third party). If Sensor Evaluation Kit SEK001 Version 1.0.exe is already installed, perform a fresh download of XLoader.zip to avoid a potential DLL conflict when using this software for the SEK002.
2	<p>Using the USB Cable, connect the SEK002/Arduino Assembly to your PC's USB port.</p>	<p>See Appendix C for selecting an internal or external power supply. If using an external source, it must be connected <u>before</u> this step to avoid damaging the SEK002/Arduino Assembly.</p> <p>If using a docking station computer, ensure that the computer is not in its docking station when installing and running the software.</p>
3	<p>Click on Sensor Evaluation Kit SEK002 Version 1.0.exe downloaded in Step 1.a. and run the software. Follow the InstallShield Wizard to complete the installation.</p> <p>If prompted for device drivers, install the VCP drivers also located in Sensor Evaluation Kit Version 1.0.exe. This step is required only when the SEK002 is connected to a USB port for the first time.</p> <ul style="list-style-type: none"> Go to your computer's Device Manager>Ports. Ensure that the Arduino UNO Virtual UART (COM) is listed and note the COM Port number. If it is not listed, look for "Unknown Device" and update the drivers with the VCPs referenced in Step 4. 	<p>A new version of the software may be installed to replace an older version. However, if you desire to replace a newer version with an older version, you will first need to uninstall the newer version.</p> <p>If you have already connected and have used an Arduino Uno Board for another purpose, a suitable VCP driver may already be installed. In this case, you will not be prompted to install a device driver.</p>
4	<p>This step flashes the firmware Arduino Firmware SEK002 Version 1.0.hex downloaded in Step 1.b to the SEK002/Arduino Assembly.</p> <ol style="list-style-type: none"> Open Xloader.zip downloaded in Step 1.c, extract the files, and run XLoader.exe. Figure 3 will appear. <p>Figure 3. Firmware Screen</p> 	<p>XLoader.exe Anti-virus software may block the XLoader.exe file from being extracted. You may need to temporarily disable your anti-virus software long enough to extract and run the XLoader software.</p> <p>Device Ensure "Uno(ATmega328)" is selected.</p>

¹ Version number may be different.

Table 3. Firmware and Software Download and Installation Process (continued)

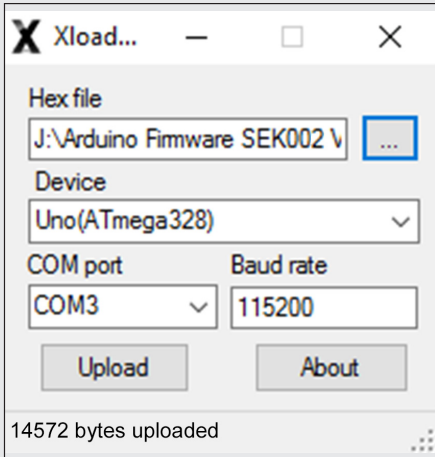
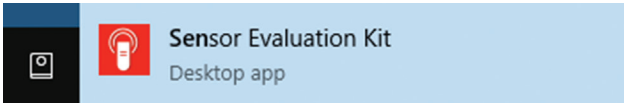
Step	Procedure	Notes and Troubleshooting
<p>4 (con't)</p>	<p>b. Ensure Figure 3 reads as follows: Hex file: Arduino Firmware SEK002 Version 1.0.hex file path Device: Uno/(ATmega328) COM port: COM39 Baud rate: 115200</p> <p>c. Click on the “Upload” button. When successfully flashed, a message similar to “14572 bytes uploaded” will be displayed, as shown in Figure 4.</p> <p>Figure 4. Firmware Screen Showing Successful Flash</p> 	<p>Ensure you are not using VCP driver version 1.2.3.0. This driver, which is known to have trouble with Xloader, may already be installed on your computer if you have used the Arduino Uno Board for another purpose. If version 1.2.3.0 is already installed, go to your computer’s Device Manager to change the driver to version 1.2.2.0, which was downloaded in Step 1.a:</p> <ol style="list-style-type: none"> Find the device in Device Manager and right click on it. Select “Update driver software”. Choose “Browse my computer for driver software” and provide the path to the VCP driver contained in the software download in Step 1.a. The default path is C:\Program Files (x86)\Honeywell\SensorEvaluationKit\VirtualCOM. This will change the VCP driver to version 1.2.2.0, which you can then verify in the driver tab of the device settings. <p>COM port Ensure the COM port is set to the COM port identified in Step 3. The port settings may have been set for a different baud rate when you installed your VCP driver. Use your computer’s Device Manager to verify the port settings and to change the baud rate to 115200, if needed.</p> <p>Baud rate Ensure the baud rate in Figure 4 matches the baud rate selected in the Device Manager port settings.</p> <p>Bytes The number of bytes given in Figure 4 is an example only. The actual number may vary according to the specific Arduino Firmware SEK002 version you downloaded. This byte count may change as this file is updated.</p>
<p>5</p>	<p>Run the “Sensor Evaluation Kit” desktop app.</p> 	<p style="text-align: center;">-</p>

4.0 SOFTWARE SCREENS

4.1 Sensor Selection Panel Screen (see Figure 5 and Table 4)

Figure 5. Sensor Selection Panel Screen

Sensor Selection Panel

Sensor type: Pressure

Sensor series: ABP Series

Part number: ABPDLNN100MG2A

Serial number: ABPDLNN100MG2A3, ABPDLNN100MG2A5

RECENT SELECTIONS

ABPDLNN100MG2A3 Pressure (ABP Series)

HIH6021-021-001' Humidity (HIH 6000)

SUBMIT CANCEL

Table 4. Sensor Selection Panel Screen Functions

Function	Description
Sensor Type	Select Sensor Type from the drop-down menu.
Sensor Series	Select the Sensor Series from the drop-down menu.
Part Number	<u>Slowly</u> begin to enter the part number of the sensor to be evaluated until all but the last several digits appear. Then, select the final part number from the remaining drop-down list. After the part number appears, click on the SUBMIT button. (Note: Do not enter the entire Part Number or copy/paste it into the field. The Part Number must be selected from the drop-down list.)
Serial Number	Not used.
RECENT SELECTIONS	If applicable, a part number may be selected from this list directly. It is not necessary to enter the Sensor Type or Series first.

Sensor Evaluation Kit, SEK002

32333651

4.2 Measurement Screen (see Figures 6, 7 and Table 5)

Note: The example given shows the display for a pressure sensor (ABP Series, MPR series). The HumidIcon products display is similar and returns the %RH (percent relative humidity) and temperature. The HPM Series Particle Sensor returns the PM2.5 in red and the PM10 in blue, both expressing concentration in $\mu\text{g}/\text{m}^3$.

Figure 6. Measurement Screen for ABP Series Only

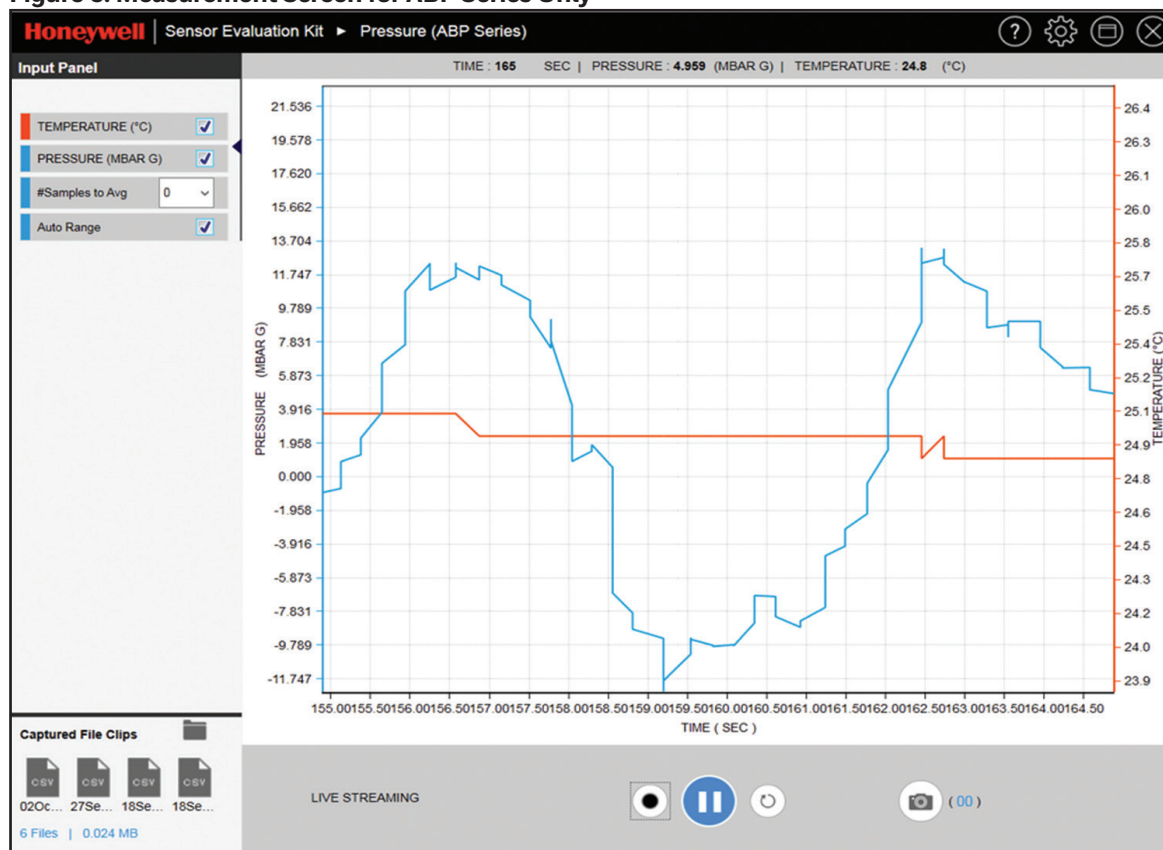

Figure 7. Captured File Clip Sample for ABP Series Only

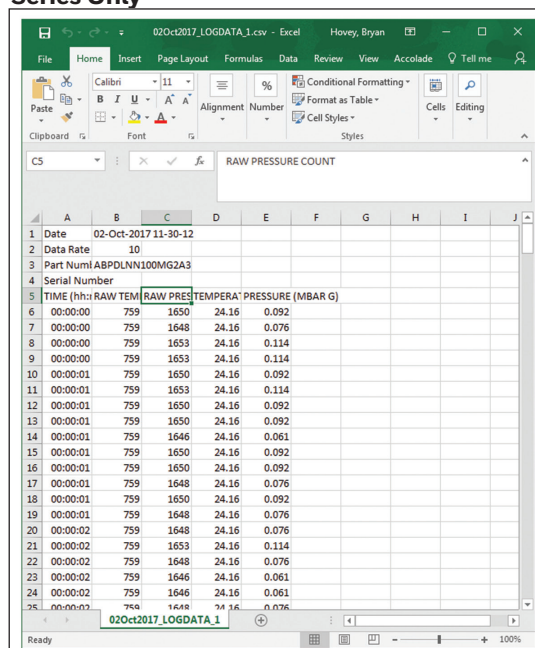

Table 5. Measurement Screen Functions for ABP Series Only

Function	Description
Input Panel:	
Temperature	Selects the desired graph parameters. Click on the “Play” button after making a selection to restart the evaluation. Displays °C or °F of the sensor’s ASIC.
Pressure	Displays the sensor’s pressure.
#Samples to Avg.	Select from the given number.
Auto Range	Select to automatically adjust to keep trace on screen.
Play/Pause	Starts/pauses the LIVE STREAMING function. Also used to restart an evaluation after changing any Input Panel characteristics.
Record	Records the measurements in a .csv file in Excel for offline analysis.
Restart	Resets the time line to 0 sec.
Snap Shot	Saves a screenshot to a selected folder.
Saved Snaps Path	Opens the folder of recent file clips and snap shots.
Captured File Clips	Displays/provides access to recent .csv files in Excel.
Part	Displays the part number of the sensor currently being evaluated.
Serial	Not displayed.

4.3 Configuration Screen (see Figure 8 and Table 6)

Figure 8. Configuration Screen

The screenshot shows a configuration window titled "CONFIGURATION" with a close button in the top right corner. It is divided into two main sections: "UNITS AND MEASUREMENT" and "OFFLINE DATA STORAGE".

UNITS AND MEASUREMENT:

- Data Format:** Two buttons are shown: "Eng Units" (highlighted in blue) and "Counts". A small information icon is to the right.
- Temperature:** Two buttons are shown: "°C" (highlighted in blue) and "°F".

OFFLINE DATA STORAGE:

- File Type:** A dropdown menu showing "CSV".
- File Name:** A text input field containing "LOGDATA".
- File Path:** A text input field containing "J:\Screen Shots" and a "BROWSE" button to its right.
- File Size Limit:** A text input field containing "1024" followed by "KB".

At the bottom of the window, there are two buttons: "SUBMIT" (highlighted in blue) and "CANCEL" (black).

Table 6. Configuration Screen Functions

Function	Description
Data Format	Selects Engineering Units or raw Counts for pressure and temperature measurement.
Temperature	Displays temperature in °C or °F of the sensor's ASIC.
File Type	Default is a .csv file which displays in Excel.
File Name	Default is LOGDATA. Change by entering a different File Name.
File Path	Default is C:\ProgramData\SensorEvalKit\Report. (Note: Drive location depends on the Windows installation location.) Change by entering a different File Path or use BROWSE.
File Size Limit	Default is 1024 kB; may be adjusted for a single file.

Sensor Evaluation Kit, SEK002

Issue A
32333651

4.4 Help Screen (see Figure 9 and Table 7)

Figure 9. Help Screen

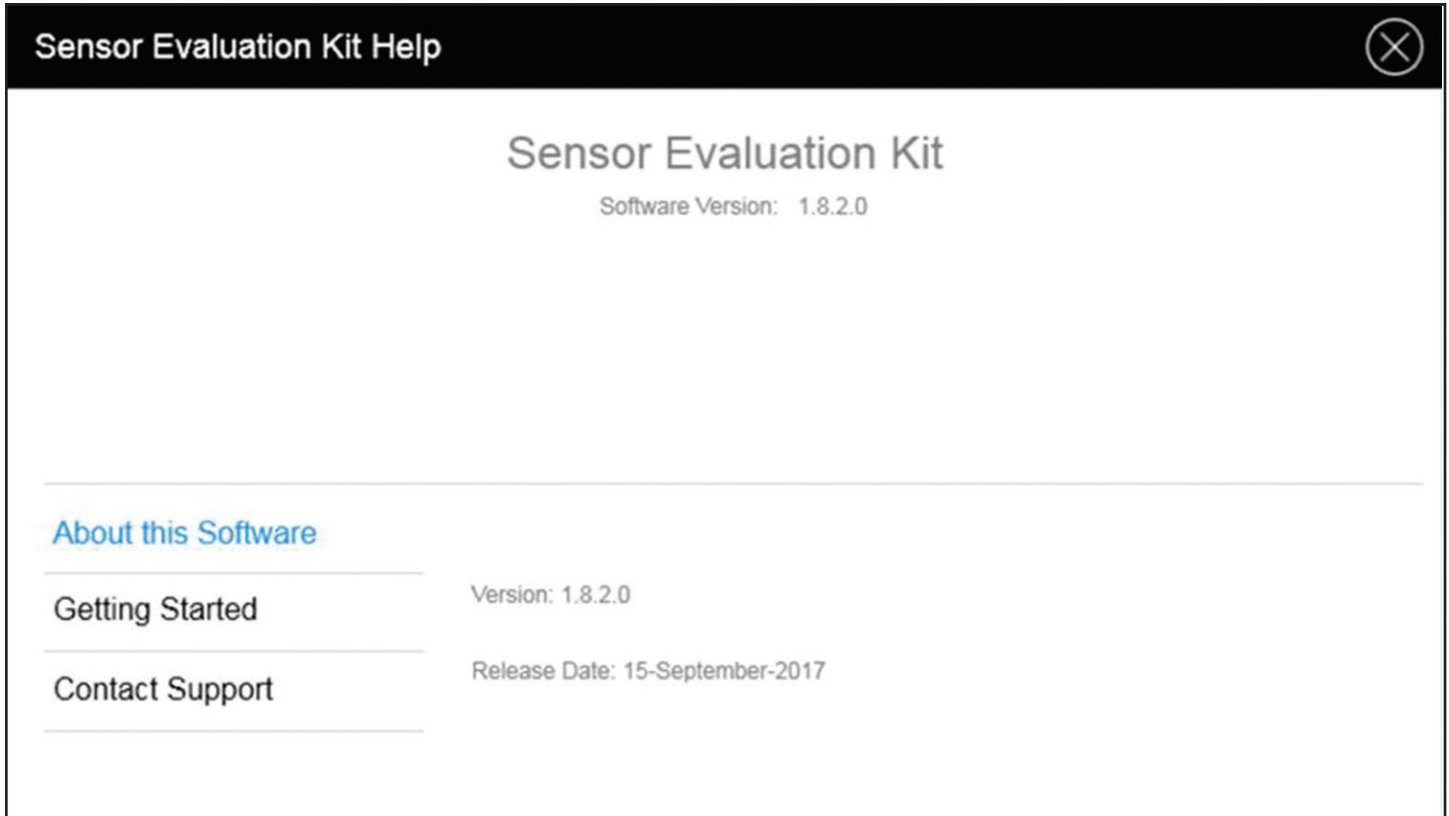

Table 7. Help Screen Functions

Function	Description
About this Software	Provides software revision number and release date.
Getting Started	Provides links to User Instructions and online sensor product information, including datasheets, installation instructions, and applications notes.
Contact Support	Requests technical support from Honeywell.

APPENDIX A. SEK002 SPECIFICATIONS

Table A1. SEK002 Specifications

Characteristic	Parameter
Temperature range ¹	20°C to 30°C [68°F to 86°F]
Humidity range ¹	30 %RH to 70 %RH
Power supply: internal (Arduino Uno Rev3) external	3.3 V or 5 V 3.3 V or 5 V
Compatible sensors	ABP Series (digital versions only) MPR Series HPM Series Honeywell Humidcon: HIH6000 Series, HIH6100 Series, HIH7000 Series, HIH8000 Series, HIH9000 Series
Associated software	Sensor Evaluation Kit SEK002 Version 1.0.exe Arduino Firmware SEK002 Version 1.0.hex XLoader.zip

¹ See Appendix B. Remote Connection if evaluation conditions are different.

APPENDIX B. REMOTE CONNECTION

Use jumper wires to connect a remotely-located sensor to either the sockets provided on the SEK002 or directly to the Arduino UNO board. See Tables B1, B2, B3, and B4 for SEK002 sockets and correlating sensor pins/pads.

Table B1. ABP Series Pinout

SEK002		Sensor			
Socket Designator	Pin	Pin/Pad Designator	I ² C Pin/Pad	SPI Pin/Pad	Function
J5	3	MISO	-	5	sensor output
J4	3	SCLK	-	6	clock
P3	5 ¹	SS	-	3	chip select for DIP
P3	6 ¹	SS	-	3	chip select for SMT
P3	7 ¹	SS	-	3	chip select for leadless SMT
P5	5 V or 3.3 V	Vsupply	2	2	supply
P5	6	GND	1	1	ground
J5	1	SDA	5	-	SDA
J4	1	SCL	6	-	SCL

¹ Use only one of these pins, depending on the package style of the sensor.

Sensor Evaluation Kit, SEK002

Issue A
32333651

Table B2. MPR Series Pinout¹

SEK002		Sensor			
Socket Designator	Pin	Pad Designator	I ² C Pad	SPI Pad	Function
T1	2	MISO	-	7	sensor output
J9	3	MOSI	-	2	sensor input
J8	3	SCLK	-	3	clock
T1	1	SS	-	1	chip select
P5	3.3 V	V _{SS}	10	10	supply
P5	6	V _{DD}	12	12	ground
J9	1	SDA	2	-	SDA
J8	1	SCL	3	-	SCL

¹ See appendix E for more information on using the MPR Series breakout boards.

Table B3. HumidIcon HIH6000 Series, HIH6100 Series, HIH7000 Series, HIH8000 Series, HIH9000 Series Pinout

SEK002		Sensor				
Socket Designator	Pin	Pin	I ² C Pin		SPI Pin, SOIC	Function
			SIP	SOIC		
P2	5	MISO	-	-	5	sensor output
P2	6	SCLK	-	-	4	clock
P2	1	CS	-	-	3	chip select
P5	5 V or 3.3 V	V _{CC}	1	8	8	supply
P5	6	GND	2	2	2	ground
J14	2	SDA	4	4	-	SDA
J13	2	SCL	3	3	-	SCL
J18	2	Hi	-	5	-	high alarm
J17	2	Low	-	6	6	low alarm

Table B4. HPM Series Pinout

Connect the HPM Series to P4 on the SEK002 using the 32332297-001 cable shown in Appendix F.

APPENDIX C. JUMPER CONFIGURATIONS

Jumper J6 may be set for either an internal power supply (furnished on the Arduino Uno Rev3) or an external power supply (furnished by the user). Although the internal voltages are approximately 3.3 Vdc and 5 Vdc, they are not exact. The difference may affect sensor output due to self-heating on the pressure die, causing some ratiometricity error.

To use an external power, remove the jumper from J6 and supply the external power to pin 3 (COM) on J6.

(Note: Make these connections prior to powering the Arduino Uno Rev3 through the USB cable in Table 3, Step 2. Ensure that the SEK002 terminals are not damaged when connecting the external power supply.)

Table C1. ABP Series Common Power Supply Selection

Output	Package Style		
	DIP	SMT	Leadless SMT
Enable	J3 (1-2)	J2 (1-2)	J1 (1-2)
I ² C	J5 (1-2), J4 (1-2)	J5 (1-2), J4 (1-2)	J5 (1-2), J4 (1-2)
SPI	J8 (2-3), J9 (2-3)	J8 (2-3), J9 (2-3)	JJ8 (2-3), J9 (2-3)

Table C2. MPR Series Common Power Supply Selection

Output	Leadless SMT Package Style
Enable	J19 (1-2)
I ² C	J8 (1-2), J9 (1-2)
SPI	J8 (2-3), J9 (2-3)

Table C3. HumidIcon HIH6000 Series, HIH6100 Series, HIH7000 Series, HIH8000 Series, HIH9000 Series Common Power Supply Selection

Output	Package Style		
	I ² C Pin		SPI Pin, SOIC
	SIP	SOIC	
Enable	J10 (1-2)	J12 (1-2)	J11 (1-2)
I ² C	-	J14 (1-2), J13 (1-2)	-
SPI	-	-	J14 (2-3), J13 (2-3)

Table C4. HPM Series Common Power Supply Selection

Output	Sensor
UART	Jumpers are not required - use cable referenced in Appendix F.

Sensor Evaluation Kit, SEK002

32333651

APPENDIX D. SEK002 EXTERNAL FEATURES AND DIMENSIONS

Figure D1. SEK002 Board Layout

Front (no jumpers shown)

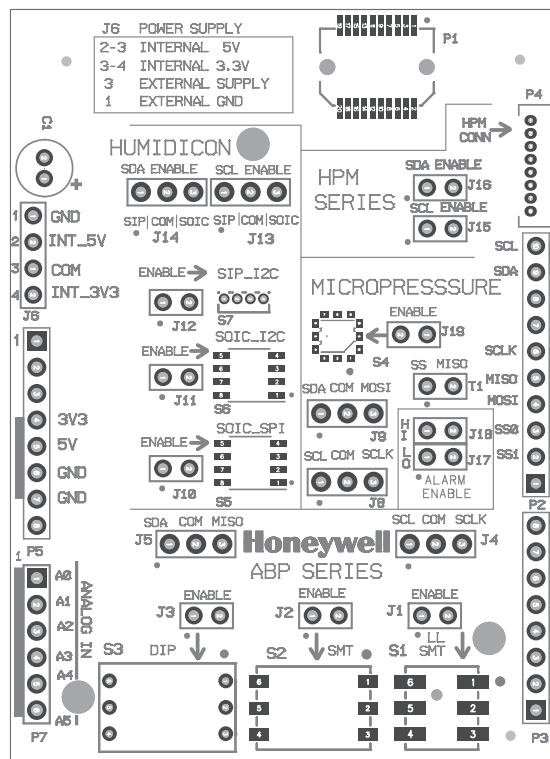
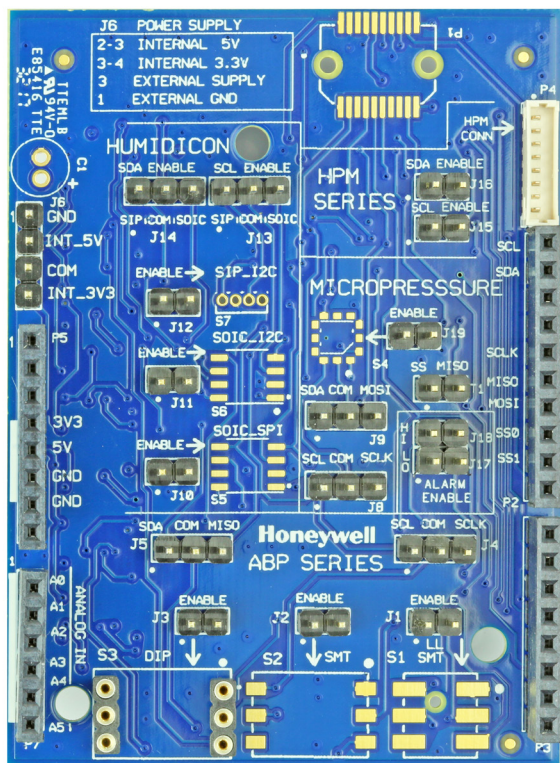

Back

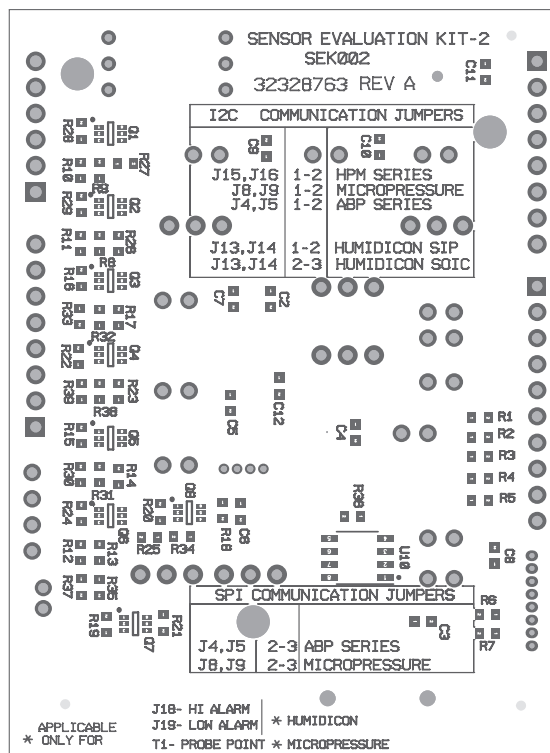
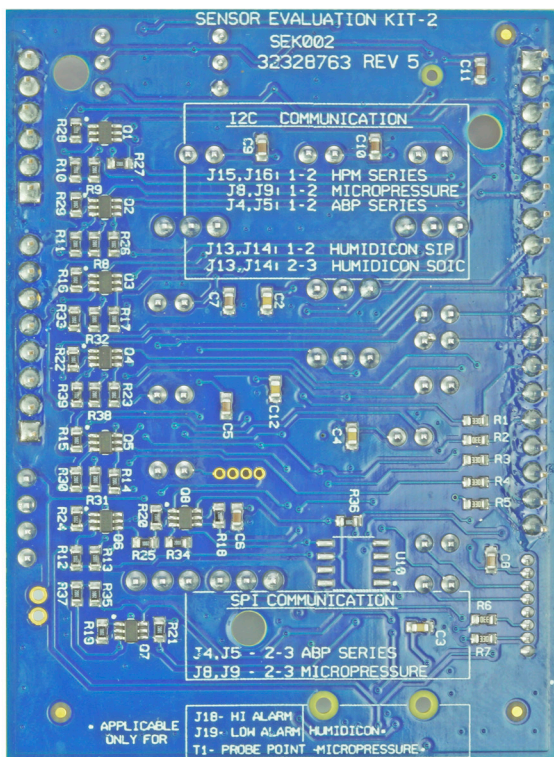

Sensor Evaluation Kit, SEK002

APPENDIX D. SEK002 EXTERNAL FEATURES AND DIMENSIONS (continued)

Figure D1. SEK002 Dimensions (For reference only: mm/[in].)

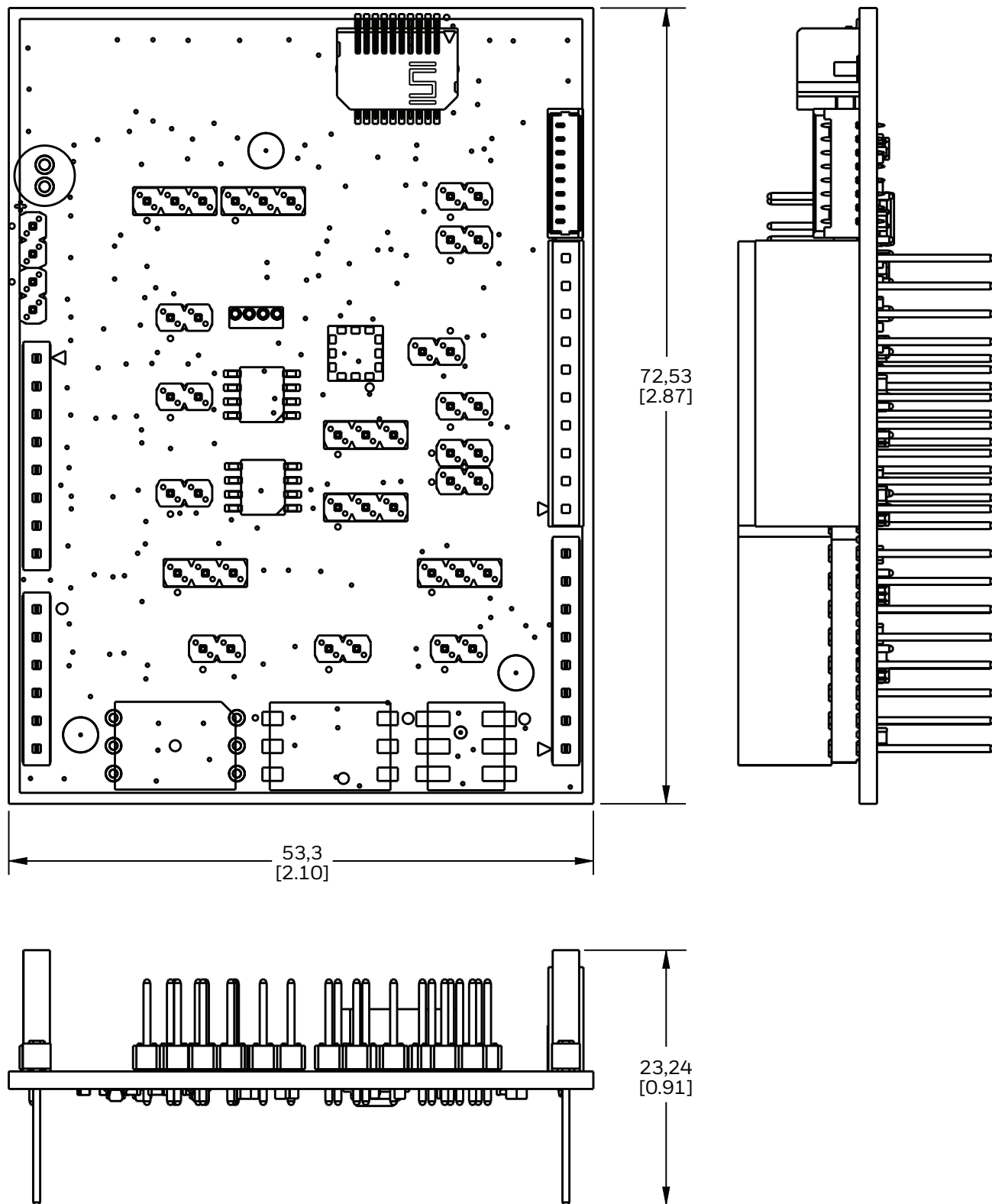

APPENDIX E. MPR Series Breakout Board

Figure E1. MPR Series Breakout Board Schematic and Dimensions

The MPR Series sensors are available on a breakout board, allowing power and communications lines to be more easily attached to a sensor without the risk of hand soldering or the expense of creating your own evaluation PCB. The breakout board can be used with the SEK002 Sensor Evaluation Kit and software or any I²C or SPI control circuit.

If the SEK002 is not used, please provide 1 kOhm pull up resistors on SCL and SDA lines when using I²C communications. Refer to the MPR Series data sheet for programming instructions.

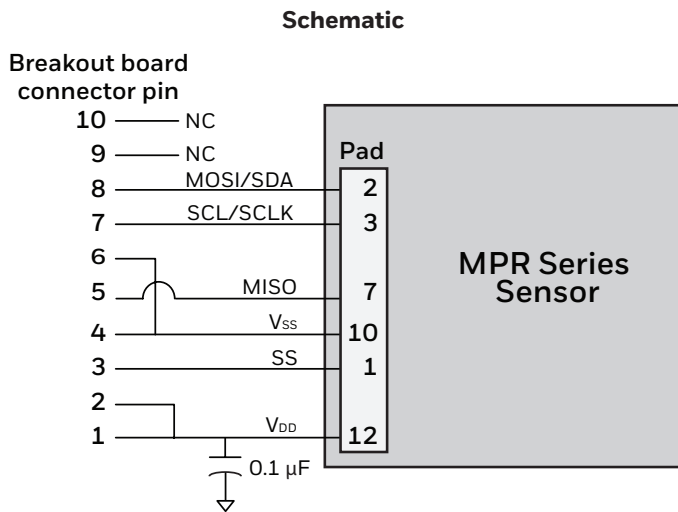

Breakout board dimensions (For reference only: mm/[in.]

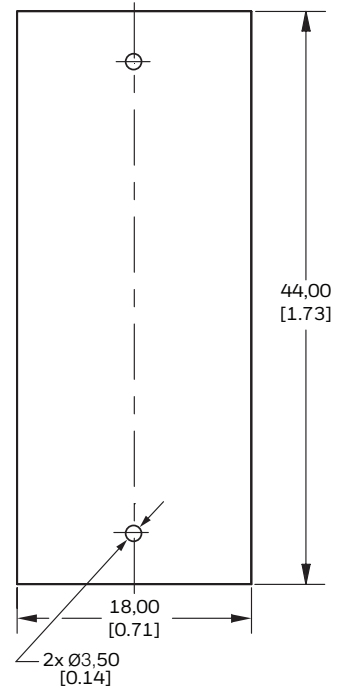

APPENDIX F. Cable 32332297-00

Figure F1. Cable 32332297-001 Dimensions

The 32332297-001 is a specialized cable, available separately from Honeywell, used to connect the HPM Series to the SEK002. Do not use cables from other manufacturers.

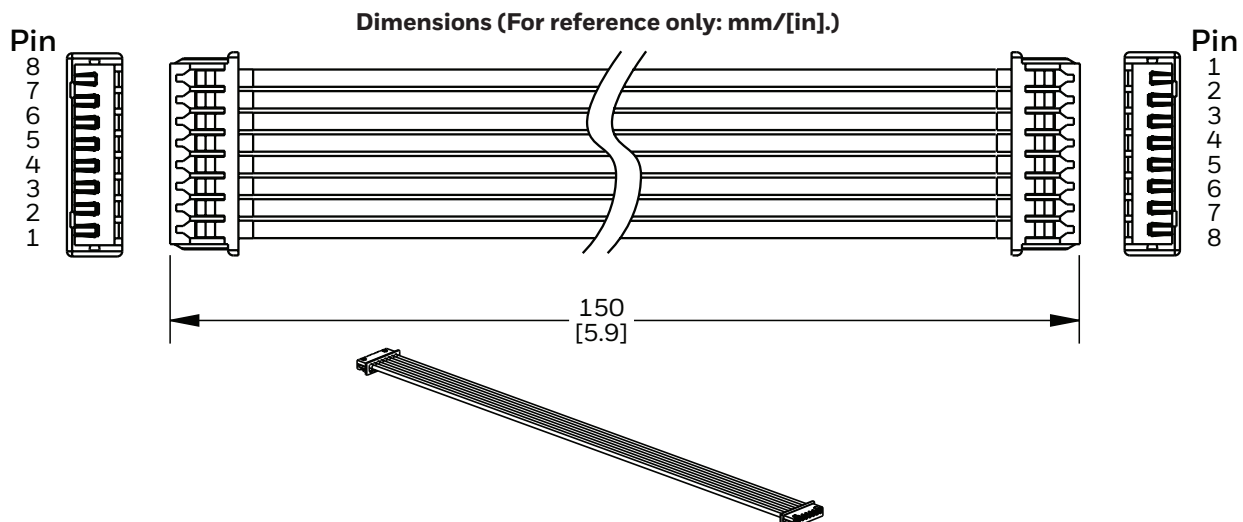

⚠ WARNING

PERSONAL INJURY

DO NOT USE these products as safety or emergency stop devices or in any other application where failure of the product could result in personal injury.

Failure to comply with these instructions could result in death or serious injury.

Warranty/Remedy

Honeywell warrants goods of its manufacture as being free of defective materials and faulty workmanship during the applicable warranty period. Honeywell's standard product warranty applies unless agreed to otherwise by Honeywell in writing; please refer to your order acknowledgement or consult your local sales office for specific warranty details. If warranted goods are returned to Honeywell during the period of coverage, Honeywell will repair or replace, at its option, without charge those items that Honeywell, in its sole discretion, finds defective. **The foregoing is buyer's sole remedy and is in lieu of all other warranties, expressed or implied, including those of merchantability and fitness for a particular purpose. In no event shall Honeywell be liable for consequential, special, or indirect damages.**

While Honeywell may provide application assistance personally, through our literature and the Honeywell web site, it is buyer's sole responsibility to determine the suitability of the product in the application.

Specifications may change without notice. The information we supply is believed to be accurate and reliable as of this writing. However, Honeywell assumes no responsibility for its use.

Honeywell serves its customers through a worldwide network of sales offices and distributors. For application assistance, current specifications, pricing or name of the nearest Authorized Distributor, contact your local sales office or:

For more information

Honeywell Sensing and Internet of Things services its customers through a worldwide network of sales offices and distributors. For application assistance, current specifications, pricing or the nearest Authorized Distributor, visit sensing.honeywell.com or call:

Asia Pacific	+65 6355-2828
Europe	+44 (0) 1698 481481
USA/Canada	+1-800-537-6945

Honeywell Sensing and Internet of Things

9680 Old Bailes Road
Fort Mill, SC 29707
www.honeywell.com

Honeywell