

MICRO SWITCH™ Commercial-Grade Toggle Switches AT Series

005435

Issue 1

Datasheet



DESCRIPTION

Honeywell's MICRO SWITCH™ AT toggle switches provide a compact multi-pole toggle switch with a long history of successful performance, exceeding 50 years. The AT Toggle Switch Series is available as a 1-, 2-, 3-, 4-, 6-, 8-, or 10-pole design for a wide range of applications with a metal toggle lever, metal bushing, and metal housing for durability. Select AT Series are qualified to MIL-PRF-8805 for military applications. For applications which do not require a military approved switch, there are other AT Series switches for commercial and industrial applications.

Options for the AT Series include panel seals and lever-to-bushing seals. These options enhance product performance where environments of dust or water spray could be present in the application. Complementing the product offering, MICRO SWITCH™ AT toggle switch assemblies are available with individual poles (basic switches) which are UL, CSA, and CE certified.

VALUE TO CUSTOMERS

- Multi-pole, multi-throw circuitry (up to 10 pole) for controlling independent circuits or providing redundant circuit capability
- Flexible insulators between poles minimize electrical bridging
- MIL-PRF-8805 qualified switches
- Reduces service costs
- Extends equipment life
- Front of panel sealing available

DIFFERENTIATION

- Only manufacturer with 10-pole circuitry
- Utilizes proven and reliable snap-action switch design

FEATURES

- Assemblies available as MIL-PRF-8805 qualified or the individual basic switches with UL, CSA, and CE certification
- 2- or 3-position, momentary and maintained action
- Up to 10 SPDT precision basic switches
- Short behind-panel depth
- Choice of 1/4- or 15/32-inch bushings
- Silver or gold contacts
- Lever lock options
- Toggle lever and panel seal options
- Electrical connections: screw, solder, quick connect (blade), and preleaded

POTENTIAL APPLICATIONS

- Aircraft (commercial and military)
- Military ground vehicles
- Flight controls
- Vehicle panel controls

PORTFOLIO

Honeywell offers six series of MICRO SWITCH™ toggle switches including the [TL Series](#), [NT Series](#), [TS Series](#), [TW Series](#), and [ET Series](#).

MICRO SWITCH™ Commercial-Grade Toggle Switches, AT Series

Table 1. Specifications

| Characteristic | Parameter |
|---|---|
| Description | Commercial-grade toggle switch; military-qualified toggle switches available |
| Actuators | Standard lever, locking lever, tab lever, special lever |
| Lever action | 2- or 3-position with maintained or momentary action |
| Mounting | Panel mount threaded bushing; Ø 1/4 in [0.25] or 15/32 in [0.47] |
| Bushing | Ø 1/4 in [0.25 in] bushing 1-, 2-, or 3-single pole double throw (SPDT) basics; Ø15/32 in [0.47 in] bushing 2-, 4-, 6-, 8-, or 10-single pole double throw (SPDT) basics |
| Termination | Solder thru-hole; solder single turret; solder double turret; screw; quick-connect blade; pre-leaded |
| Contact material | Silver alloy or gold-plated silver alloy |
| Electrical rating | 30 Vdc; 125 Vac; 250 Vac (See Tables 2 & 3) |
| Electrical endurance (commercial grade) | 6,000 cycles min. |
| Electrical endurance (military qualified) | 25,000 cycles min. |
| Sealing | Unsealed; lever-to-bushing seal; panel seal & lever-to-bushing seal |
| Operating temperature | -55 °C to 85 °C [-67 °F to 185 °F] |
| Approvals | Available as MIL-PRF-8805; or UL, CSA, CE [individual basic switches] Select catalog listings with FAA-PMA |

Table 2. 6AT/13AT/23AT Series with MICRO SWITCH™ SM type basic switch electrical ratings (amps)













| Supply voltage (contact material) | UL/CSA/CE rating for SM basic switch | Sea Level | | | Altitude 50,000 ft | | |
|---|--------------------------------------|------------------------|-----------|-----------|----------------------|-----------|-----------|
| | | Inrush @ 30 Vdc [max.] | Resistive | Inductive | Inrush @ 30 Vdc max. | Resistive | Inductive |
| 30 Vdc (silver contacts) | – | 24 | 5 | 3 | 24 | 5 | 2.5 |
| 30 Vdc (gold contacts) | – | 2 | 1 | 0.5 | 2 | 1 | 0.5 |
| 125 Vac, UL/CSA 250 Vac, CE (gold contacts) | 1 | – | – | – | – | – | – |
| 250 Vac (silver contacts) | 5 | – | – | – | – | – | – |

Table 3. 60AT Series with MICRO SWITCH™ SX type basic switch electrical ratings (amps)

| Supply voltage (contact material) | UL/CSA/CE rating for SX basic switch | Sea Level | | Altitude 50,000 ft | |
|-----------------------------------|--------------------------------------|-----------|-----------|--------------------|-----------|
| | | Resistive | Inductive | Resistive | Inductive |
| 28 Vdc (silver contacts) | – | 7 | 4 | 4 | 2.5 |
| 115 Vac, 60 Hz (silver contacts) | – | 7 | 7 | – | – |
| 250 Vac (silver contacts) | 7 | – | – | – | – |

MICRO SWITCH™ Commercial-Grade Toggle Switches, AT Series

Figure 1. MICRO SWITCH™ AT Series Locking Configurations

| | | | | | | |
|---|---|---|---|--|---|---|
|  Locked In Three Positions |  Locked In Center and Extreme Position (Keyway Side) |  Locked Out Of Center Position |  Locked In Center Position |  Locked In Extreme Position (Opposite Keyway) |  Locked In Extreme Position (Keyway Side) |  Locked Out Of Center And Extreme Position (Keyway Side) |
|  Locked Out Of Center And Extreme Position (Opposite Keyway) |  Locked In Center And Extreme Position (Opposite Keyway) |  Locked Out Of Extreme Position (Keyway Side) |  Locked Out Of And Into Extreme Position (Opposite Keyway) |  Locked Out Of Extreme Position (Opposite Keyway) |  Locked Out Of And Into Extreme Position (Keyway Side) | |

TERMINAL CIRCUIT IDENTIFICATION (BOTTOM VIEW)

Terminal markings (electrical connections) are identified in the order guide section with a C (for common), NC (for normally closed), and NO (for normally open). In addition, the poles (basic switches) of the AT toggle switch are identified with a number marked on the end of the basic switch (i.e. a four pole switch will have each pole (basic switch) marked 1, 2, 3, or 4 on the end of each basic switch.

Figure 2. 6AT Series with 1PDT, 2PDT, or 3PDT

| | 1-Pole | 2-Pole | 3-Pole |
|-------------------|-------------|-------------|-------------|
| Key tab or keyway | C • NO • NC | C • NO • NC | C • NO • NC |
| | | C • NO • NC | C • NO • NC |
| | | | C • NO • NC |

Figure 3. 13AT Series with 2PDT, 3PDT, or 4PDT

| | 2-Pole | | 3-Pole | | 4-Pole | |
|--------|--------|-------------|--------|-------------|--------|-------------|
| Keyway | 2 | C • NO • NC | 3 | NC • NO • C | 4 | NC • NO • C |
| | 1 | NC • NO • C | 2 | C • NO • NC | 3 | C • NO • NC |
| | | | 1 | NC • NO • C | 2 | C • NO • NC |
| | | | | | 1 | NC • NO • C |

Figure 4. 23AT Series with 2PDT, 3PDT, or 4PDT

| | 2-Pole | 3-Pole | 4-Pole |
|--------|-------------|-------------|-------------|
| Keyway | C • NO • NC | C • NO • NC | C • NO • NC |
| | C • NO • NC | C • NO • NC | C • NO • NC |
| | | C • NO • NC | C • NO • NC |
| | | | C • NO • NC |

Figure 5. 62AT Series (2PDT)

| | 2-Pole | |
|--------|--------|-------------|
| Keyway | 1 | NC • NO • C |
| | 2 | NC • NO • C |

Figure 6. 64AT Series (4PDT)

| | | | | |
|--------|---|-------------|---|-------------|
| Keyway | 1 | NC • NO • C | 3 | C • NO • NC |
| | 2 | NC • NO • C | 4 | C • NO • NC |

Figure 7. 66AT Series (6PDT)

| | | | | |
|--------|---|-------------|---|-------------|
| Keyway | 1 | NC • NO • C | 4 | C • NO • NC |
| | 2 | NC • NO • C | 5 | C • NO • NC |
| | 3 | NC • NO • C | 6 | C • NO • NC |

Figure 8. 68AT Series (8PDT)

| | | | | |
|--------|---|-------------|---|-------------|
| Keyway | 1 | NC • NO • C | 5 | C • NO • NC |
| | 2 | NC • NO • C | 6 | C • NO • NC |
| | 3 | NC • NO • C | 7 | C • NO • NC |
| | 4 | NC • NO • C | 8 | C • NO • NC |

MICRO SWITCH™ Commercial-Grade Toggle Switches, AT Series

13AT SERIES THREE-POSITION ORDER GUIDE

Table 4. Three-Position 13AT Series

| No. of Poles/ Basic Switches | Toggle Lever Position | | | Contact Material | Standard Lever | Metal Tab Lever | Pull-to-unlock Lever | Lever-Lock Suffix ¹ |
|---------------------------------|--|---------------------|--|------------------|---|---|---|--|
| | Keyway | Center | Opposite Keyway | | Solder Termination No Suffix (thru-hole), -T Suffix (turrent), -T2 Suffix (double turrent) | Solder Termination with -T2 Suffix (double turrent) | Add Lever Lock Suffix to Cat. Listing Below | |
| 2 | Pole 1, C-NC Pole 2, C-NO | Both Poles, C-NC | Pole 1, C-NO Pole 2, C-NC | Silver | 13AT2, 13AT2-T | 13AT402-T2 | 13AT2- | All lever lock types |
| 2 | Pole 1, C-NC Pole 2, C-NO | Both Poles, C-NC | Pole 1*, C-NO Pole 2*, C-NC | Silver | 13AT3 | - | - | Lever lock types E, G, B, L, N, or P |
| 2 | Pole 1*, C-NC Pole 2*, C-NO | Both Poles, C-NC | Pole 1*, C-NO Pole 2*, C-NC | Silver | 13AT1, 13AT1-T | 13AT401-T2 | 13AT1- | Lever lock types E, L, or N |
| 2 | Pole 1*, C-NC Pole 2*, C-NO | Both Poles, C-NC | Pole 1*, C-NO Pole 2*, C-NC | Gold | 13AT26 | - | - | Lever lock types E, L, or N |
| 4 | Pole 1, C-NC Pole 2, C-NO Pole 3, C-NO Pole 4, C-NC | All Poles, C-NC | Pole 1, C-NO Pole 2, C-NC Pole 3, C-NC Pole 4, C-NO | Silver | 13AT9-T2 | - | 13AT9- | All lever lock types |
| 4 | Pole 1, C-NC Pole 2, C-NO Pole 3, C-NO Pole 4, C-NC | All Poles, C-NC | Pole 1*, C-NO Pole 2*, C-NC Pole 3*, C-NC Pole 4*, C-NO | Silver | 13AT10 | - | - | Lever lock types E, G, B, L, N, or P |
| 4 | Pole 1*, C-NC Pole 2*, C-NO Pole 3*, C-NO Pole 4*, C-NC | All Poles, C-NC | Pole 1*, C-NO Pole 2*, C-NC Pole 3*, C-NC Pole 4*, C-NO | Silver | 13AT8 | - | 13AT8- | Lever lock types E, L, or N |

* These positions are momentary. All other positions are maintained

C = Common Terminal; NC = Normally Closed Terminal; NO = Normally Open Terminal

¹ See page 3 for lever lock configurations

MICRO SWITCH™ Commercial-Grade Toggle Switches, AT Series

13AT SERIES THREE-POSITION ORDER GUIDE

Table 5. Three-Position MIL-PRF-8805 13AT Catalog listings

| No. of Poles/ Basic Switches | Toggle Lever Position | | | | Standard Lever Solder Termination -T2 Suffix (double turrent) | | Metal Tab Lever Solder Termination -T2 Suffix (double turrent) | | Pull-to-Unlock Lever ¹ | |
|---------------------------------|--|------------------|---|------------------|--|----------------------|---|----------------------|-----------------------------------|------------------------------|
| | Keyway | Center | Opposite Keyway | Contact Material | Catalog Listing | Military Part Number | Catalog Listing | Military Part Number | Catalog Listing | Military Part Number |
| 2 | Pole 1, C-NC Pole 2, C-NO | Both Poles, C-NC | Pole 1, C-NO Pole 2, C-NC | Silver | 13AT272-T2 | M8805/26-007 | - | - | 13AT272-T2-A 13AT272-T2-M | M8805/92-006 M8805/92-014 |
| 2 | Pole 1, C-NC Pole 2, C-NO | Both Poles, C-NC | Pole 1*, C-NO Pole 2*, C-NC | Silver | 13AT273-T2 | M8805/26-009 | - | - | - | - |
| 2 | Pole 1*, C-NC Pole 2*, C-NO | Both Poles, C-NC | Pole 1*, C-NO Pole 2*, C-NC | Silver | 13AT271-T2 | M8805/26-005 | 13AT471-T2 | M8805/26-006 | 13AT271-T2-E | M8805/92-005 |
| 3 | Pole 1, C-NC Pole 2, C-NO Pole 3, C-NC | All Poles, C-NC | Pole 1*, C-NO Pole 2*, C-NC Pole 3*, C-NO | Silver | 13AT275-T2 | M8805/26-013 | 13AT475-T2 | M8805/26-014 | - | - |

* These positions are momentary. All other positions are maintained

C = Common Terminal; NC = Normally Closed Terminal; NO = Normally Open Terminal

¹See page 3 for lever lock configurations

MICRO SWITCH™ Commercial-Grade Toggle Switches, AT Series

23AT SERIES TWO-POSITION ORDER GUIDE

Table 6. Two-Position 23AT Series

| No. of Poles/ Basic Switches | Toggle Lever Position | | Contact Material | Standard Lever | Metal Tab Lever | Pull-to-unlock Lever | Lever-lock Suffix ¹ |
|------------------------------------|-----------------------|--------------------|---------------------|---|---|---|-----------------------------------|
| | Keyway | Opposite Keyway | | Solder Termination No Suffix (thru- hole), -T2 Suffix (double turrent) | Solder Termination with -T2 Suffix (double turrent) | Add Lever Lock Suffix to Cat. Listing below | |
| 2 | C-NO ea Pole | C-NC ea Pole | Silver | 23AT1, 23AT1-T2 | 23AT402-T2 | 23AT1- | D, F, or G |
| 2 | C-NO ea Pole | C-NC ea Pole | Gold | 23AT11, 23AT11-T2 | - | 23AT1- | D, F, or G |
| 2 | C-NO ea Pole* | C-NC ea Pole | Silver | 23AT4, 23AT4-T2 | 23AT403-T2 | - | - |
| 2 | C-NO ea Pole* | C-NC ea Pole | Gold | 23AT19 | - | - | - |
| 3 | C-NO ea Pole | C-NC ea Pole | Silver | 23AT2, 23 AT2-T2 | - | 23AT2- | D, F, or G |
| 3 | C-NO ea Pole* | C-NC ea Pole | Silver | 23AT5 | - | - | - |
| 4 | C-NO ea Pole | C-NC ea Pole | Silver | 23AT3, 23AT-T2 | - | 23AT3- | D, F, or G |
| 4 | C-NO ea Pole | C-NC ea Pole | Gold | 23AT8 | - | - | - |
| 4 | C-NO ea Pole* | C-NC ea Pole | Silver | 23AT6, 23AT6-T2 | - | - | - |

* These positions are momentary. All other positions are maintained

¹ See page 3 for lever lock configurations

23AT SERIES TWO-POSITION ORDER GUIDE

Table 7. Two-Position MIL-PRF-8805 23AT Catalog listings

| No. of Poles/ Basic Switches | Toggle Lever Position | | Contact Material | Standard Lever Solder Termination -T2 Suffix (double turrent) | | Metal Tab Lever Solder Termination -T2 Suffix (double turrent) | | Pull-to-Unlock Lever ¹ | |
|------------------------------------|--------------------------|--------------------|---------------------|---|----------------------------|--|----------------------------|-----------------------------------|----------------------------|
| | Keyway | Opposite Keyway | | Catalog Listing | Military Part Number | Catalog Listing | Military Part Number | Catalog Listing | Military Part Number |
| 2 | C-NO ea Pole | C-NC ea Pole | Silver | 23AT73-T2 | M8805/26- 001 | 23AT473-T2 | M8805/26- 003 | 23AT73- T2-D | M8805/92- 001 |
| 4 | C-NO ea Pole | C-NC ea Pole | Silver | 23AT74-T2 | M8805/26- 002 | - | - | 23AT74- T2-D | M8805/92- 002 |
| 4 | C-NO ea Pole | C-NC ea Pole | Silver | - | - | - | - | 23AT74- T2-G | M8805/92- 004 |

* These positions are momentary. All other positions are maintained

¹ See page 3 for lever lock configurations

MICRO SWITCH™ Commercial-Grade Toggle Switches, AT Series

6AT SERIES TWO-POSITION ORDER GUIDE

Table 8. Two-Position 6AT Series

| Bushing Size | No. of Poles/ Basic Switches | Toggle Lever Position | | Contact Material | Standard Lever |
|--|---------------------------------|-----------------------|--------------------|---------------------|---|
| | | Keyway | Opposite Keyway | | Solder Termination No Suffix (thru-hole), -T Suffix (turrent) |
| 1/4 (0.25) inch Ø bushing with key tab | 1 | C-NO | C-NC | Silver | 6AT2; 6AT2-T |
| | 1 | C-NO | C-NC | Gold | 6AT23 |
| | 2 | C-NO ea Pole | C-NC ea Pole | Silver | 6AT3; 6AT3-T |
| | 2 | C-NO ea Pole | C-NC ea Pole | Gold | 6AT13 |
| | 3 | C-NO ea Pole | C-NC ea Pole | Silver | 6AT501; 6AT501-T |
| 1/4 (0.25) inch Ø bushing without key tab | 1 | C-NO | C-NC | Silver | 6AT1; 6AT1-T |
| | 2 | C-NO | C-NC | Silver | 6AT4 |
| 15/32 (0.47) inch Ø bushing with key washer | 1 | C-NO | C-NC | Silver | 6AT6 |
| | 1 | C-NO | C-NC | Gold | 6AT17 |
| | 2 | C-NO ea Pole | C-NC ea Pole | Silver | 6AT7 |
| | 2 | C-NO ea Pole | C-NC ea Pole | Gold | 6AT42 |
| | 3 | C-NO ea Pole | C-NC ea Pole | Silver | 6AT10; 6AT10-T |

* These positions are momentary. All other positions are maintained

60AT SERIES TWO-POSITION ORDER GUIDE

Table 9. Two-Position 60AT Series

| No. of Poles/ Basic Switches | Toggle Lever Position | | Standard Lever | Standard Lever | Pull-to-unlock Lever ¹ |
|---------------------------------|---|---|------------------------------|----------------------------------|---|
| | Keyway | Opposite Keyway | Mil-S-6743 Basic Switches | MIL-PRF-8805/4 Basic Switches | Add Lever Lock Suffix "Letter" to Cat. Listing |
| 2 | C-NC ea Pole | C-NO ea Pole | 62AT11-3 | 62AT22-3 | D, G |
| 2 | C-NC ea Pole | C-NO ea Pole* | - | 62AT22-82 | G |
| 4 | C-NC Pole 1,2; C-NO Pole 3,4 | C-NC Pole 3,4; C-NO Pole 1,2 | 64AT11-3 | 64AT22-3 | D, F, G |
| 6 | C-NC Pole 1,2,3; C-NO Pole 4,5,6 | C-NC Pole 4,5,6; C-NO Pole 1,2,3 | 66AT11-3 | 66AT22-3 | D, F, G |
| 8 | C-NC Pole 1,2,3,4; C-NO Pole 5,6,7,8 | C-NC Pole 5,6,7,8; C-NO Pole 1,2,3,4 | - | 68AT22-3 | D, F, G |

* These positions are momentary. All other positions are maintained

¹ See page 3 for lever lock configurations

MICRO SWITCH™ Commercial-Grade Toggle Switches, AT Series

60AT SERIES TWO-POSITION ORDER GUIDE

Table 10. Two-position 60AT Series per MIL-PRF-8805/98 (with Bushing and Panel Seals)

| No. of Poles/ Basic Switches | Toggle Lever Position | | Standard Lever | Standard Lever | Pull-to-Unlock Lever ¹ | Pull-to-Unlock Lever ¹ |
|---------------------------------|---|---|------------------|---------------------|--|--------------------------------------|
| | Keyway | Opposite Keyway | Catalog Listing | Military Number | Add Lever Lock Suffix "Letter" to Standard Lever TOGGLE Switch | Military Number |
| 4 | C-NC Pole 1,2; C-NO Pole 3,4 | C-NC Pole 3,4; C-NO Pole 1,2 | 64AT300-3 | M8805/98-015 | D, F, G | M8805/98-** |
| 6 | C-NC Pole 1,2,3; C-NO Pole 4,5,6 | C-NC Pole 4,5,6; C-NO Pole 1,2,3 | 66AT300-3 | M8805/98-046 | D, F, G | M8805/98-** |
| 8 | C-NC Pole 1,2,3,4; C-NO Pole 5,6,7,8 | C-NC Pole 5,6,7,8; C-NO Pole 1,2,3,4 | 68AT300-3 | M8805/98-077 | D, F, G | M8805/98-** |

** Add the appropriate 3 digit suffix to the military number

¹ See page 3 for lever lock configurations

60AT SERIES THREE-POSITION ORDER GUIDE

Table 11. Three-Position 60AT Series

| No. of Poles/ Basic Switches | Toggle Lever Position | | | Standard Lever | Standard Lever | Pull-to-Inlock Lever ¹ |
|---------------------------------------|--|--------------|--|------------------------------|----------------------------------|---|
| | Keyway | Center | Opposite Keyway | Mil-S-6743 Basic Switches | MIL-PRF-8805/4 Basic Switches | Add Lever Lock Suffix Options to Cat. Listing |
| 4 | C-NC Pole 1,2; C-NO Pole 3,4 | C-NC ea Pole | C-NC Pole 3,4; C-NO Pole 1,2 | 64AT11-1 | 64AT22-1 | All lever lock options |
| 4 | C-NC Pole 1,2,* C-NO Pole 3,4* | C-NC ea Pole | C-NC Pole 3,4; C-NO Pole 1,2 | 64AT11-5 | 64AT22-5 | E,F,K,L,M,N |
| 4 | C-NC Pole 1,2; C-NO Pole 3,4 | C-NC ea Pole | C-NC Pole 3,4* C-NO Pole 1,2* | - | 64AT22-514 | B,E,G,L,N,P |
| 4 | C-NC Pole 1,2,* C-NO Pole 3,4* | C-NC ea Pole | C-NC Pole 3,4* C-NO Pole 1,2* | 64AT11-7 | 64AT22-7 | E,L,N |
| 6 | C-NC Pole 1,2,3; C-NO Pole 4,5,6 | C-NC ea Pole | C-NC Pole 4,5,6; C-NO Pole 1,2,3 | 66AT11-1 | 66AT22-1 | All lever lock options |
| 6 | C-NC Pole 1,2,3* C-NO Pole 4,5,6* | C-NC ea Pole | C-NC Pole 4,5,6; C-NO Pole 1,2,3 | 66AT11-5 | 66AT22-5 | E,F,K,L,M,N |
| 6 | C-NC Pole 1,2,3; C-NO Pole 4,5,6 | C-NC ea Pole | C-NC Pole 4,5,6* C-NO Pole 1,2,3* | 66AT11-514 | - | B,E,G,L,N,P |
| 6 | C-NC Pole 1,2,3* C-NO Pole 4,5,6* | C-NC ea Pole | C-NC Pole 4,5,6* C-NO Pole 1,2,3* | 66AT11-7 | 66AT22-7 | E,L,N |
| 8 | C-NC Pole 1,2,3,4; C-NO Pole 5,6,7,8 | C-NC ea Pole | C-NC Pole 5,6,7,8; C-NO Pole 1,2,3,4 | 68AT11-1 | 68AT22-1 | All lever lock options |
| 8 | C-NC Pole 1,2,3,4* C-NO Pole 5,6,7,8* | C-NC ea Pole | C-NC Pole 5,6,7,8; C-NO Pole 1,2,3,4 | 68AT11-5 | 68AT22-5 | E,F,K,L,M,N |
| 8 | C-NC Pole 1,2,3,4* C-NO Pole 5,6,7,8* | C-NC ea Pole | C-NC Pole 5,6,7,8* C-NO Pole 1,2,3,4* | 68AT11-7 | 68AT22-7 | E,L,N |

* These positions are momentary. All other positions are maintained

¹ See page 3 for lever lock configurations

MICRO SWITCH™ Commercial-Grade Toggle Switches, AT Series

60AT SERIES THREE-POSITION ORDER GUIDE

Table 12. Three-position 60AT Series per MIL-PRF-8805/98 (with Bushing and Panel Seals)

| No. of Poles/ Basic Switches | Toggle Lever Position | | | Standard Lever | Standard Lever | Pull-to-Un-lock Lever ¹ | Pull-to-Un-lock Lever ¹ |
|---------------------------------|---|-----------------|---|-----------------|-----------------|--|------------------------------------|
| | Keyway | Center | Opposite Keyway | Catalog Listing | Military Number | Add Lever Lock Suffix "Letter" to Standard Lever Toggle Switch | Military Number |
| 4 | C-NC Pole 1,2; C-NO Pole 3,4 | C-NC ea Pole | C-NC Pole 3,4 C-NO Pole 1,2 | 64AT300-1 | M8805/98-001 | All lever lock types | M8805/98- ^{**} |
| 4 | C-NC Pole 1,2,* C-NO Pole 3,4* | C-NC ea Pole | C-NC Pole 3,4 C-NO Pole 1,2 | 64AT300-5 | M8805/98-019 | E,F,K,L,M,N | M8805/98- ^{**} |
| 4 | C-NC Pole 1,2,* C-NO Pole 3,4* | C-NC ea Pole | C-NC Pole 3,4,* C-NO Pole 1,2* | 64AT300-7 | M8805/98-026 | E,L,N | M8805/98- ^{**} |
| 6 | C-NC Pole 1,2,3; C-NO Pole 4,5,6 | C-NC ea Pole | C-NC Pole 4,5,6; C-NO Pole 1,2,3 | 66AT300-1 | M8805/98-032 | All lever lock types | M8805/98- ^{**} |
| 6 | C-NC Pole 1,2,3,* C-NO Pole 4,5,6* | C-NC ea Pole | C-NC Pole 4,5,6; C-NO Pole 1,2,3 | 66AT300-5 | M8805/98-050 | E,F,K,L,M,N | M8805/98- ^{**} |
| 6 | C-NC Pole 1,2,3,* C-NO Pole 4,5,6* | C-NC ea Pole | C-NC Pole 4,5,6,* C-NO Pole 1,2,3* | - | M8805/98-057 | 66AT300-7* E,L,N | M8805/98- ^{**} |
| 8 | C-NC Pole 1,2,3,4; C-NO Pole 5,6,7,8 | C-NC ea Pole | C-NC Pole 5,6,7,8; C-NO Pole 1,2,3,4 | 68AT300-1 | M8805/98-063 | All lever lock types | M8805/98- ^{**} |
| 8 | C-NC Pole 1,2,3,4,* C-NO Pole 5,6,7,8* | C-NC ea Pole | C-NC Pole 5,6,7,8; C-NO Pole 1,2,3,4 | - | M8805/98-081 | 68AT300-5* E,F,K,L,M,N | M8805/98- ^{**} |
| 8 | C-NC Pole 1,2,3,4,* C-NO Pole 5,6,7,8* | C-NC ea Pole | C-NC Pole 5,6,7,8,* C-NO Pole 1,2,3,4* | - | M8805/98-092 | 68AT300-7* E,L,N | M8805/98- ^{**} |

* Momentary position. All other positions are maintained.

** Add the appropriate 3 digit suffix to the military number

+ Add the lever lock "letter" to the base catalog listing

¹ See page 3 for lever lock configurations

MICRO SWITCH™ Commercial-Grade Toggle Switches, AT Series

DIMENSIONAL DRAWINGS

Figure 9. 13/23AT Series, Standard Lever

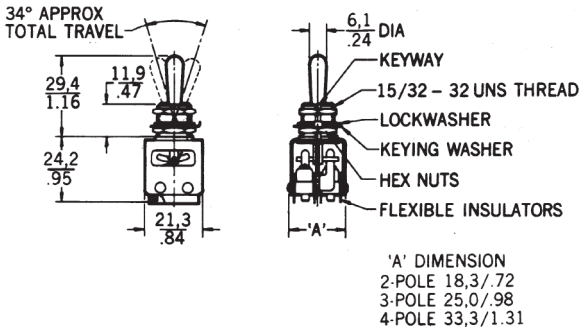

Figure 14. 62AT Series, Standard Lever

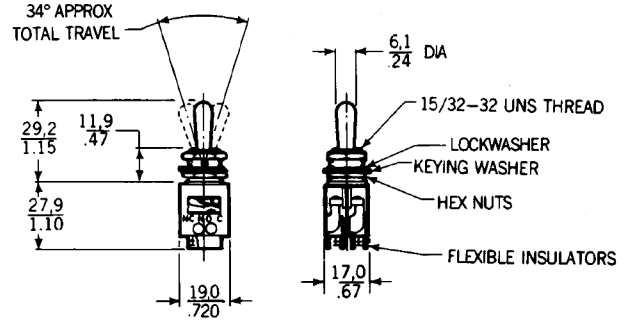

Figure 10. 13/23AT Series, Tab Lever

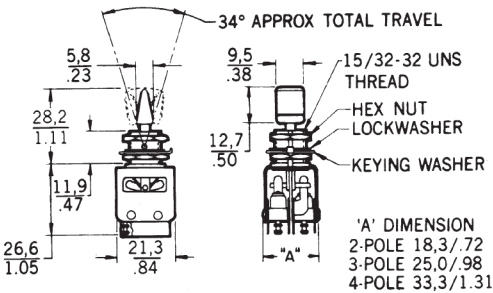

Figure 15. 64/66/68AT Series, Locking Lever

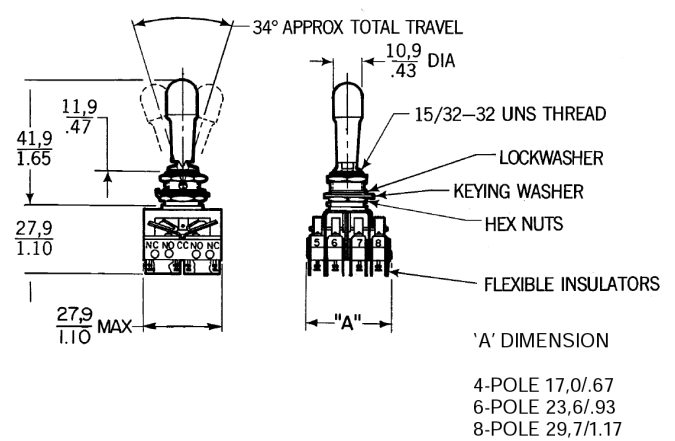

Figure 11. 13/23AT Series, Locking Lever

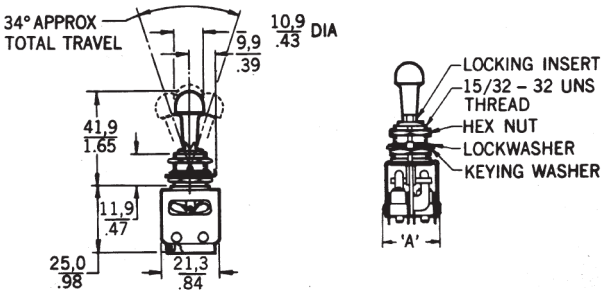

Figure 16. Panel Cutouts

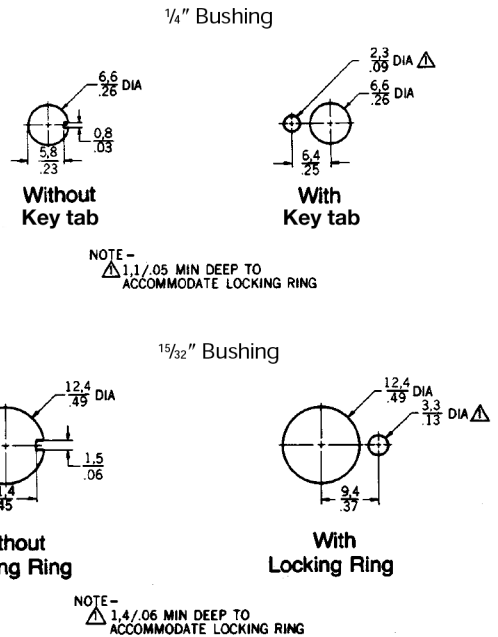

Figure 12. 6AT Series, with Keying Washer

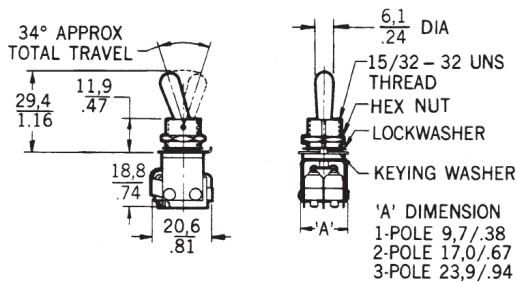
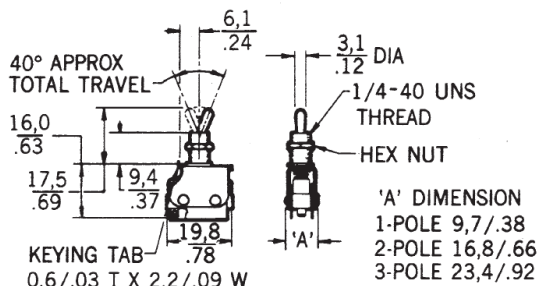

Figure 13. 6AT Series, Bushing with Key Tab



NOTE—
64AT300, 66AT300, and 68AT300 (M8805/98) listings have a bushing seal and MS25196 panel seal.

ADDITIONAL MATERIALS

The following associated literature is available on the Honeywell web site at sensing.honeywell.com:

- Product line guide
- Product range guide
- Application note: Flight deck toggle switches
- Application note: Sensors and switches in oil rig applications

WARNING **PERSONAL INJURY**

DO NOT USE these products as safety or emergency stop devices or in any other application where failure of the product could result in personal injury.

Failure to comply with these instructions could result in death or serious injury.

WARNING **MISUSE OF DOCUMENTATION**

- The information presented in this product sheet is for reference only. Do not use this document as a product installation guide.
- Complete installation, operation, and maintenance information is provided in the instructions supplied with each product.

Failure to comply with these instructions could result in death or serious injury.

Find out more

Honeywell serves its customers through a worldwide network of sales offices, representatives and distributors. For application assistance, current specifications, pricing or name of the nearest Authorized Distributor, contact your local sales office.

To learn more about Honeywell's sensing and switching products, call **+1-815-235-6847** or **1-800-537-6945**, visiting sps.honeywell.com.

Warranty/Remedy

Honeywell warrants goods of its manufacture as being free of defective materials and faulty workmanship. Honeywell's standard product warranty applies unless agreed to otherwise by Honeywell in writing; please refer to your order acknowledgement or consult your local sales office for specific warranty details. If warranted goods are returned to Honeywell during the period of coverage, Honeywell will repair or replace, at its option, without charge those items it finds defective. **The foregoing is buyer's sole remedy and is in lieu of all other warranties, expressed or implied, including those of merchantability and fitness for a particular purpose. In no event shall Honeywell be liable for consequential, special, or indirect damages.**

While we provide application assistance personally, through our literature and the Honeywell web site, it is up to the customer to determine the suitability of the product in the application.

Specifications may change without notice. The information we supply is believed to be accurate and reliable as of this printing. However, we assume no responsibility for its use.

Honeywell Sensing and Productivity Solutions

9680 Old Bailes Road
Fort Mill, SC 29707
honeywell.com

005435-1-EN IL50 GLO
© 2022 Honeywell International Inc. All rights reserved.

Honeywell

Mouser Electronics

Authorized Distributor

Click to View Pricing, Inventory, Delivery & Lifecycle Information:

Honeywell:

[68AT300-7L](#) [66AT11-82G](#) [64AT300-1](#) [64AT300-3](#) [64AT300-3D](#) [64AT300-5](#) [64AT300-5E](#) [64AT300-5M](#) [64AT300-5N](#) [64AT43-5](#) [68AT22-1](#) [68AT22-1A](#) [68AT22-3](#) [68AT22-3D](#) [68AT22-5](#) [68AT22-7](#) [6AT1](#) [6AT10](#) [6AT10-T](#) [6AT13](#) [6AT13-T2](#) [6AT17](#) [6AT17-T2](#) [6AT2](#) [6AT23](#) [6AT2-T](#) [6AT3](#) [6AT3-T](#) [6AT4](#) [6AT42](#) [6AT501](#) [6AT501-T](#) [6AT6](#) [6AT7](#) [6AT70](#) [6AT7-T](#) [64AT201-1](#) [64AT23-7E](#) [64AT305-3](#) [64AT305-3D](#) [64AT305-5E](#) [64AT305-5M](#) [64AT34-7L](#) [64AT811-1E](#) [66AT550-5](#) [66AT11-514](#) [66AT11-514G](#) [66AT300-1](#) [66AT300-1M](#) [66AT300-3](#) [66AT300-3D](#) [66AT300-3F](#) [66AT300-5](#) [66AT300-7E](#) [66AT305-3F](#) [66AT315-1](#) [66AT65-5K](#) [68AT203-1](#) [68AT203-1A](#) [68AT203-5](#) [68AT203-5E](#) [68AT300-1](#) [68AT300-3D](#) [68AT303-1A](#) [68AT305-3D](#) [6AT1-T](#)