

Pressure and Force Sensors

Output Signal Adjustment and Temperature Compensation for 24PC and FS Series – Note #1

INTRODUCTION

Many pressure and force sensor applications require close control over performance parameters such as sensitivity, linearity, hysteresis, and others. Using computer controlled laser trimming on the 140/160PC and 240PC pressure sensors, MICRO SWITCH provides this close control and higher performance than can be achieved using discrete circuitry. Temperature compensation circuitry is an integral part of the device and is optimized on each unit as part of the calibration procedure. Null offset and Span are similarly controlled. No adjustment or recalibration by the user is required.

26 and 176PC sensors provide interchangeability from unit to unit and provide other limited temperature compensation. The 26 and 176PC are voltage excited.

The 24PC and FS feature a wider tolerance on null offset and Span and do not include temperature compensation. The following procedures can be used to set the null offset and Span to desired output values (0-100 mV typically) and to compensate for temperature shift.

OUTPUT SIGNAL ADJUSTMENT

Setting Null Offset to Zero

1. Measure null offset (lead 2 to 4).
2. For a negative null offset place a resistor from lead 1 (supply) to lead 2 (positive output). Expect values around 300K ohms (**Figure 1A**).
3. For a positive null offset place a resistor from lead 1 (supply) to lead 4 (negative output). Expect values around 300K ohms (**Figure 1B**).

Setting Span

1. Measure the bridge resistance (R_B) from lead 2 to 4 (output).
2. Measure Span.
3. Calculate a shunt resistor (R_S) using the following equation:

$$R_S = \frac{R_B}{\frac{K_M}{K_D} - 1}$$

Where:

K_M = measured Span

K_D = desired Span

Generally: $5K < R_S < 20K$ ohms

4. Install shunt resistor from lead 2 to 4 (output) as in **Figure 2**.

Figure 1A
If null offset is negative

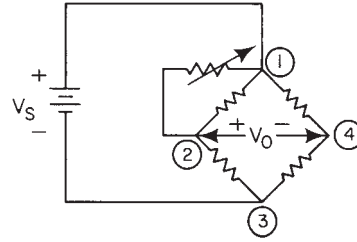

Figure 1B
If null offset is positive

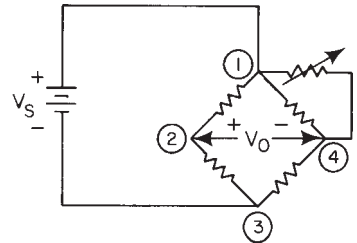
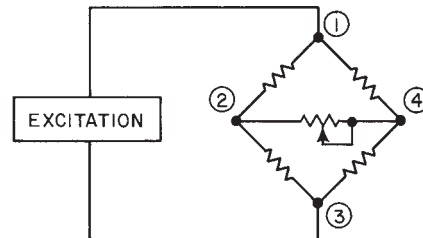

Figure 2
Setting Span



Pressure and Force Sensors

Output Signal Adjustment and Temperature Compensation for 24PC and FS Series – Note #1

TEMPERATURE COMPENSATION¹

Introduction

The 24PC pressure and FS force sensors exhibit the following effects as temperature increases:

1. Pressure or force sensitivity decreases.²
2. The resistance of each piezoresistor increases.²

For illustration, consider the following piezoresistor model:

$$R(P, T) = C_T(R_o + C_p k(25^\circ\text{C})P)$$

Where:

R(P, T) is the value of the piezoresistance (ohm)

R_o is the unstressed (ambient) piezoresistance at 25°C

$$R_o = R(P = 0, T = 25^\circ\text{C})$$

C_T is the change in R(P, T) with temperature.

$$C_T = \frac{R(P = 0, T)}{R_o} \left(\frac{\text{ohm}}{\text{ohm}} \right)$$

k(25°C) is the pressure or force sensitivity at 25°C

$$k(25^\circ\text{C}) = \frac{R(P, 25^\circ\text{C}) + R_o}{P} \left(\frac{\text{ohm}}{\text{psi or g}} \right)$$

k(T) is the pressure or force sensitivity at applied temperature.

C_p is the change in pressure or force sensitivity with temperature.

$$C_p = \frac{k(T)}{k(25^\circ\text{C})} \frac{\text{ohm/psi or g}}{\text{ohm/psi or g}}$$

P is the applied pressure (psi)

F is the applied force (g)

Nominal C_p and C_T characteristics are given in **Figure 3**.

Method #1

The circuit of **Figure 4** provides temperature compensation by combining a current source and positive feedback. Essentially, the change in C_T is partially cancelled by an opposite change in C_p.

For a different supply voltage, vary the 24.9K resistor. Make sure that the common mode input voltage and output voltage swing limitations of the amplifiers are not exceeded.

24PC sensors are less sensitive to temperature when current excited. We strongly urge that current excitation be considered as a means of minimizing errors due to temperature changes. Feel free to contact the application center to get an update on this subject.

Figure 3
24PC Nominal Piezoresistor Characteristics

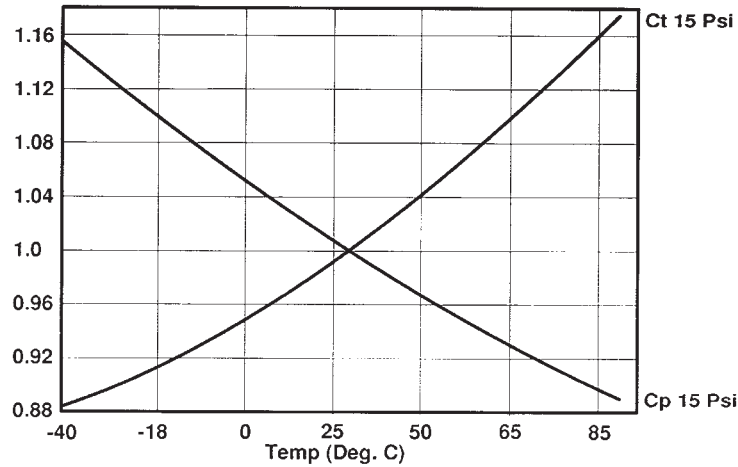
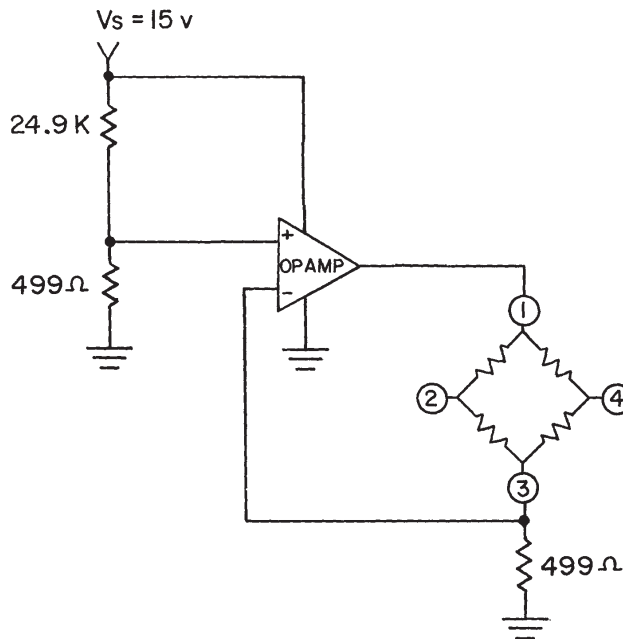

Figure 4
Temperature Compensation Method #1

Recommended Op Amps:
LM358—Dual Op Amp
LM124—Quad, military grade Op Amp



¹ Temperature Compensation Methods #1-2 affect the **sensitivity** of the sensor, not the null offset, in that the change in the slope of the output curve caused by temperature is minimized.

² Consistent from unit to unit within a narrow tolerance.

Pressure and Force Sensors

Output Signal Adjustment and Temperature Compensation for 24PC and FS Series – Note #1

Method #2

C_o is inversely proportional to temperature. To compensate for this effect, the voltage applied to the sensor bridge must be proportional to temperature. One approach is to connect a thermistor with a negative temperature coefficient (resistance decreases with temperature) in series with the bridge, as shown in **Figure 5A**. Thermistors with the exact resistance vs. temperature characteristics to compensate the bridge may not be readily available. An alternate approach is the use of a thermistor-resistor network to meet the required characteristics. Standard 1% resistor values (with a standard thermistor) are shown in **Figure 5B**. This method provides temperature compensation to within $\pm 2\%$ Span over the range of -10° to 50°C . The thermistor should be located close to the sensor, so they will experience the same thermal environment.

Figure 5
Temp. Comp. Method #2

Figure 5A

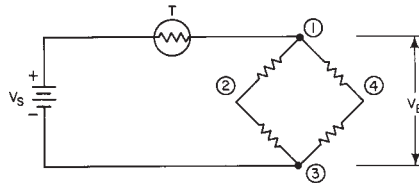
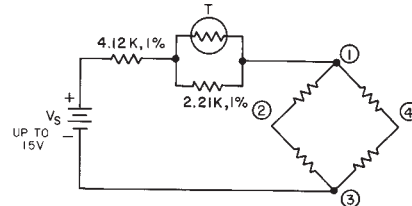

Figure 5B
Dale Thermistor 2M1501* or equivalent



*Dale Electronics, Inc.
North Fork, NB

Figure 6
Null Temperature Compensation

- (A) Customer supplied temperature compensation
- (B) Built-in temperature compensation

TEMPERATURE COMPENSATION TO CONTROL SHIFT OF NULL OFFSET

Null shift caused by temperature can be compensated using the circuit in **Figure 6**. However, it is required that the sensor first have sensitivity temperature compensation. In other words, you must use a 26 and 176 or a 24PC or FS employing one of Methods 1 or 2.

Null shift with temperature is unpredictable; therefore the sensors must be compensated individually.

1. Measure $V_{2,3}$ and $V_{2,4}$ at null over the temperature range of interest (room temperature (T_R), and some other temperature (T)).
2. Measure $R_{2,3}$ at room temperature.
3. Select R_1 for $V_n = V_{2,3}$ at room temperature.
4. Calculate the value of R_2 necessary to compensate the measured null shift.

$$R_2 = R_{2,3} \left[\frac{V_{2,3(T)} - V_{2,3(T_R)}}{V_{2,4(T)} - V_{2,4(T_R)}} \right]$$

5. Connect R_2 to terminal 2 if $V_{2,4(T)} - V_{2,4(T_R)}$ is positive. Connect it to terminal 4 if negative.

