

INSTALLATION INSTRUCTIONS FOR THE **HONEYWELL PRESSURE SWITCHES** **HIGH PRESSURE: HP SERIES, HE SERIES** **MEDIUM PRESSURE: MH SERIES, ME SERIES** **LOW PRESSURE: LP SERIES, LE SERIES**

50038194

Issue E

(3.5 psi to 4500 psi [0,24 bar to 310,26 bar])

CE, UKCA

IEC/EN-60947-5-1

MECHANICAL REQUIREMENTS

Installation Requirement

The Honeywell Pressure Switches, High Pressure, Medium Pressure, and Low Pressure, are capable of being mounted in any orientation via a threaded port. A 27 mm hexagonal wrench should be used to install the pressure switch. Installation torque should be based on the information in Table 1. Installation of the pressure switch shall permit usage of maximum 27 mm hex box spanner, modified socket wrench, and open-ended wrench.

INSTALLATION



CAUTION

PRODUCT DAMAGE

- Use a hex wrench for installation. DO NOT exceed a torque level based on the information in Table 1. Never apply torque to the connector housing or the body of the pressure switch.
- Do not subject the pressure switch to high temperatures from soldering, brazing, or welding of the system plumbing or operating environments above the specified maximum temperature.

Failure to comply with these instructions could result in death or serious injury.

Ensure the power supply is off while wiring.

TABLE 1. INSTALLATION TORQUE

Thread	Torque (Nm)	Standard
M10 × 1.0	15	ISO 6149-3
M12 × 1.5	25	ISO 6149-3
M14 × 1.5	35	ISO 6149-3
M18 × 1.5	45	ISO 6149-3
1/2-20 UNF	25	SAE J1926-3
9/16-18 UNF	30	SAE J1926-3
7/16-20 UNF	18	SAE J1926-3
3/4-16 UNF	50	SAE J1926-3
7/8-14 UNF	60	SAE J1926-3
G1/8 BSPP	25	ISO 1179-3
G1/4 BSPP	50	ISO 1179-3
1/4-18 NPT	1-Screw in until handtight	ASME B 1.20.1
1/8-27 NPT		
1/8-27 PTF		
R1/8 BSPT	2-Then tighten the product by two to three threads using wrench	
R1/2 - 14 BSPT		
R1/2 BSPT		
R1/4 BSPT		

The pressure switch can withstand a side load (acting perpendicular to the mounted axis) of 100 Newton at the end of the integral connector in its mounted orientation. This load requirement is for any incidental physical abuse during installation or intended use.

OVERPRESSURE



CAUTION

PRODUCT DAMAGE

- Do not exceed the operating pressure.

Failure to comply with these instructions could result in death or serious injury.

If the operating pressure is exceeded, the life of the Honeywell pressure switch may be reduced and electrical failure may occur. Both static and dynamic over-pressuring must be considered, particularly in hydraulic system applications. Hydraulic pressure fluctuations can have very high and rapid pressure spikes, as in a water hammer effect. The high pressure versions (HP Series, HE Series) have a snubber feature built-in to reduce the peak pressure applied to the pressure switch. The medium and low pressure versions (ME Series, LP Series, LE Series) do not employ this feature.

If system pressure pulses are expected, choose a pressure switch with a proof pressure rating high enough to allow operation at the highest expected pressure spikes.

MEDIA COMPATIBILITY



CAUTION

PRODUCT DAMAGE

- Use non-abrasive, chemically compatible media to prevent damage to the pressure switch.

Failure to comply with these instructions could result in death or serious injury.

The pressure switch's fluid path is an assembly of zinc-plated steel, stainless steel, DuPont™ Teflon®-coated Kapton®, and nitrite. The Series is compatible with a wide variety of petroleum-based fluids, air, water, and mineral oil-based brake fluid. Please confirm your media compatibility or speak with a Honeywell Application Engineer.

WIRING INSTRUCTIONS

NOTICE

To ensure proper environmental sealing and electrical connections when using a connector, follow the connector manufacturer's installation guidelines. All terminal cavities must be sealed using the correct wire gauge and seal combination. If only two leads are used, any additional terminal cavities should be sealed per the connector manufacturer's installation guide. Honeywell recommends using a crimping tool for crimping wires to the connector terminals. Contact the individual connector manufacturer for connector wiring.

FUNCTIONAL TEST

Connect the pressure switch to the pressure source (off). Based on the pressure switch's specified normally open (NO) or normally closed (NC) output, connect the electrical termination to a dc voltage supply. With no pressure on the pressure switch, turn on the power supply and ensure that the pressure switch is in the correct NO or NC position. Apply the appropriate set point pressure to ensure that the NO or NC contact position of the switch will switch over.

TABLE 1. SPECIFICATIONS

Characteristic	HP Series	HE Series	ME Series	MH Series	LP Series	LE Series
Product length (various terminations)	see pages 5 and 6	see page 5	see page 8	see page 7	see page 9	see page 9
Product length (blade)	see pages 5 and 6	see page 5	see page 8	see page 7	see page 9	see page 9
Product length (#8-32 screws)	see pages 5 and 6	see page 5	see page 8	see page 7	see page 9	see page 9
Product length (Metripack)	see pages 5 and 6	see page 5	see page 8	see page 7	see page 9	see page 9
Hex size	27 mm	27 mm	27 mm	27 mm	27 mm	27 mm
Ease of installation	box spanner	box spanner	box spanner	box spanner	box spanner	box spanner
Snap-action switch	yes	yes	no	no	yes	no
Set point ¹ range	100 psi to 4500 psi	150 psi to 4500 psi	25 psi to 350 psi	40 psi to 500 psi	3.5 psi to 150 psi	3.5 psi to 150 psi
Set point ranges	6 (Base Style A) 7 (Base Style B)	6	4	4	4	4
Set point accuracy @ 25 °C (before test)	100 psi to 150 psi (±10 %); 150 psi to 500 psi (±6 %); 501 psi to 4000 psi (±3.5 %); 4000 psi to 4500 psi (±2 %)	150 psi to 1000 psi (±1.4%); 1000 psi to 2000 psi (±1.2 %); 2000 psi to 4000 psi (±1.1 %); >4000 psi (±10 %)	25 psi to 50 psi (±3 psi); >50 psi to 100 psi (±7 psi); >100 psi to 150 psi (±10 psi); >150 psi to 250 psi (±13 psi); >250 psi to 350 psi (±16 psi)	40 psi to 70 psi (±7 psi); >70 psi to 130 psi (±10 psi); >130 psi to 200 psi (±15 psi); >200 psi to 280 psi (±20 psi); >280 psi to 350 psi (±30 psi); >350 psi to 500 psi (±40 psi)	3.5 psi to 10 psi (±1 psi); >10 psi to 50 psi (±3 psi); >50 psi to 100 psi (±7 psi); >100 psi to 150 psi (±10 psi)	
Average deadband max.	n/a	n/a	25 psi to 50 psi (20 psi); >50 psi to 100 psi (30 psi); >100 psi to 150 psi (40 psi); >150 psi to 250 psi (50 psi); >250 psi to 350 psi (60 psi)	40 psi to 70 psi (±6 psi); >70 psi to 130 psi (±10 psi); >130 psi to 200 psi (±15 psi); >200 psi to 280 psi (±20 psi); >280 psi to 350 psi (±30 psi); >350 psi to 500 psi (±40 psi)	n/a	3.5 psi to 10 psi (±2.8 psi); >10 psi to 50 psi (±1.4 psi); >50 psi to 100 psi (±3.8 psi); >100 psi to 150 psi (±4.0 psi)
Operating pressure ²	5,000 psi max.	5,000 psi max.	500 psi max.	600 psi max.	250 psi max.	250 psi max.
Proof pressure ³	10,000 psi (Base Style A) 6,500 psi (Base Style B)	10,000 psi	4,000 psi	6,000 psi	500 psi	500 psi
Hysteresis	5 % to 55 % (based on set point range)	3 % to 65 % (based on set point range)	n/a	n/a	5 % to 55 % (based on set point range)	n/a
Burst pressure ⁴	20,000 psi (Base Style A); 9,000 psi (Base Style B)	20,000 psi	8,000 psi	9,000 psi	1250 psi	1250 psi
Current rating (resistive)	5 A at 250 Vac 5 A at 24 Vdc	3 A at 250 Vac 3 A at 24 Vdc	7.5 mA to 3 A, 24 Vdc and 250 Vac	100 mA to 3 A max.	7.5 mA to 5 A, 24 Vdc and 250 Vac	7.5 mA to 3 A, 24 Vdc and 250 Vac
Current rating (inductive)	5 A at 115 Vac (SX rating); 3 A at 28 Vdc	n/a	n/a	n/a	1 A at 28 Vdc	n/a
Rated thermal current	5 A	3 A	3 A	n/a	5 A	3 A
Rated insulation voltage	28 V	28 V	28 V	n/a	28 V	28 V
Short-circuit protective device c-type max. rating	Class J fuse (10 A, 600 V)			n/a	Class J fuse (10 A, 600 V)	

¹Port Style C: Switches less than 975 psi will use Base Style B; switches greater than 975 psi will use Base Style A.

Port Styles F and G: Switches less than 350 psi will use Base Style B; switches greater than 350 psi will use Base Style A.

Port Styles A, B, E, M, P, T, and Y will use Base Style B.

Switches less than 150 psi will only use Base Style B.

TABLE 1. SPECIFICATIONS

Characteristic	HP Series	HE Series	ME Series	MH Series	LP Series	LE Series
Conditional short circuit current	1000 A			n/a	1000 A	1000 A
Pollution degree	3 (macro environment)			n/a	3 (macro environment)	
Temperature rating	-40 °C to 120 °C [-40 °F to 248 °F]	-40 °C to 85 °C [-40 °F to 185 °F]	-40 °C to 120 °C [-40 °F to 248 °F]			
Media connection	multiple ports available	multiple ports available	multiple ports available			
Pressure ports	Refer to product nomenclature for pressure port types.	C = 1/2-20 UNF F = M14 × 1.5 G = 9/16-18 UNF H = 3/4-16 UNF K = M18 × 1.5 N = 7/8-14 UNF	A = 1/4-18 NPT B = 1/8-27 NPT C = 1/2-20 UNF D = 1/8-27 PTF E = M12 × 1.5 F = M14 × 1.5 G = 9/16-18 UNF H = 3/4-16 UNF J = G1/8 BSPP M = 7/16-20 UNF R = R1/8 BSPT T = M10 × 1.0 V = R1/2 BSPT Y = G1/4 BSPP Z = R1/4 BSPT	A = 1/4-18 NPT B = 1/8-27 NPT C = 1/2-20 UNF D = 1/8-27 PTF E = M12 × 1.5 F = M14 × 1.5 G = 9/16-18 UNF H = 3/4-16 UNF J = G1/8 BSPP L = 3/8-24 UNF M = 7/16-20 UNF P = 1/2-14 NPT R = R1/8 BSPT T = M10 × 1.0 V = R1/2 BSPT Y = G1/4 BSPP Z = R1/4 BSPT	A = 1/4-18 NPT B = 1/8-27 NPT C = 1/2-20 UNF D = 1/8-27 PTF E = M12 × 1.5 F = M14 × 1.5 G = 9/16-18 UNF H = 3/4-16 UNF J = G1/8 BSPP M = 7/16-20 UNF R = R1/8 BSPT T = M10 × 1.0 V = R1/2 BSPT Y = G1/4 BSPP Z = R1/4 BSPT	A = 1/4-18 NPT B = 1/8-27 NPT C = 1/2-20 UNF D = 1/8-27 PTF E = M12 × 1.5 F = M14 × 1.5 G = 9/16-18 UNF H = 3/4-16 UNF J = G1/8 BSPP M = 7/16-20 UNF R = R1/8 BSPT T = M10 × 1.0 V = R1/2 BSPT Y = G1/4 BSPP Z = R1/4 BSPT
Circuit forms ⁵	SPDT, SPST - NO/NC		SPDT, SPST - NO/NC	SPST - NO/NC	SPDT, SPST - NO/NC	SPDT, SPST - NO/NC
Smart pressure	single- or dual-resistor topology available			–	single- or dual-resistor topology available	
Life	2 million (Base A) 1 million (Base B)	1 million	1 million	1 million	2 million	1 million
Agency approvals (special use switches)	–	–	–	–	–	–
Agency approvals (other)	CE, UKCA	CE, UKCA	CE, UKCA	CE, UKCA	CE, UKCA	CE, UKCA
Field adjustability ⁶	no	no	yes	yes	yes	yes
Spike dampening	yes	yes	no	no	no	no
Ingress protection ⁷	IP67 (connectors) IP67 (wire/Base A) IP69K (wire/Base B) IP00 (blade/screw)	IP67 (connectors) IP00 (blade/screw)	IP67 (connectors) IP67 (wire out) IP00 (blade/screw)	IP67 (connectors) IP00 (blade/screw)	IP67 (connectors) IP67 (wire out) IP00 (blade/screw)	IP67 (connectors) IP67 (wire out) IP00 (blade/screw)
Vibration resistance	swept sine: 10 Hz to 2000 Hz at 15 g, 20 min/sweep; 8 hours in each axis random: 5 Hz to 2000 Hz, 8 hours/axis; 14,88 g-RMS, each axis					
Shock resistance	500 m/sec ² , 11 mSEC, 100 shocks / axis			500 m/sec ² , 11 mSEC		
Wetted part (diaphragm)	n/a		Kapton [®] (Teflon [®] coated)	Nitrile/EPDM/LTNB	Kapton [®] (Teflon [®] coated)	Tefzel [®]
Wetted part (piston)	nitrile o-ring, steel piston		nitrile or EPDM o-ring	nitrile or EPDM o-ring	nitrile or EPDM o-ring	nitrile or EPDM o-ring
Weight	133 g [4.7 oz] (Base Style A) 178 g [6.28 oz] (Base Style B)		53 g [1.9 oz]	53 g [1.9 oz]	58 g [2.0 oz]	53 g [1.9 oz]
Contacts	silver / gold inlay	silver	gold plated	gold plated	gold plated	gold plated
Product finish	zinc plating	zinc plating	zinc plating	zinc plating	zinc plating	zinc plating

¹Set point: Point at which switch actuates or de-actuates

²Operating pressure: Maximum normal system operating pressure

³Proof pressure: Maximum pressure that the switch can handle while it maintains set point accuracy. Intermittent spikes to this level are acceptable.

⁴Burst pressure: Point of complete switch failure

⁵SPST: Single pole, single throw. SPDT: Single pole, double throw. NO: Normally open. NC: Normally closed.

⁶Field adjustability only available with AA, BA, CA, and DA (SPST only) terminations.

⁷IP00 for AA and BA terminations.

TABLE 2. TERMINATIONS

Series	Available Terminations
HP, HE, ME, LP, LE	AA = Spade Terminals
	BA = Screw Terminals
	CA = Deutsch DT04-3P-E005 (3-Pin Connector)
	DA = Amp Super Seal 1.5 - 282105-1 (3-Pin Connector)
	EA = 10-inch Cable, 18 AWG (Wire Out, No Connector)
	FA = 10-inch Cable w/Deutsch DT04-3P-E005 (3-Pin Connector) (16 AWG)*
	GA = 10-inch Cable w/Amp Super Seal 1.5 - 282105-1 (3-Pin Connector) (18 AWG)*
	HA = 10-inch Cable w/Metripack 280 Delphi 15300002 (2-Pin Connector) (18 AWG)*
	JA = 10-inch Cable w/Din43650-C (3-Pin Connector) (18 AWG)*
	KA = 10-inch Cable w/M12x1 (Brad Harrison Micro) - 21032121306 Harting P/N (3-Pin Connector) (18 AWG)*
	LA = 10-inch Cable w/Packard Weatherpack Male Terminal - 12020827 (3-Pin Connector) (18 AWG)*
	MA = 10-inch Cable w/Deutsch DT04-2P-E005 (2-Pin Connector) (18 AWG)
	NA = 3-inch Cable w/Packard 2P Tower Connector - 12015792 (2-Pin Connector) (18 AWG)
	PA = 2.75-inch Cable w/Packard 2P Shroud Connector - 12010973 (2-Pin Connector) (18 AWG)
	RA = 4-inch Cable w/Packard 2P Shroud Connector - 12010973 (2-Pin Connector) (16 AWG)
	SA = 5.5-inch Cable w/ITT Cannon 2P Sure-Seal Circular Connector - SS2R-120-1804-000 (2-Pin Connector) (18 AWG)
	TA = 8.5-inch Cable w/ITT Cannon 3P Sure-Seal Circular Connector - SS3R-120-8551-001 (3-Pin Connector) (16 AWG)*
	UA = 10-inch Cable - Vacuum Impregnated w/Deutsch DT06-3S-EP06 (3-Socket Connector) (16 AWG)*
	VA = 10-inch Cable - Vacuum Impregnated w/Deutsch DT04-3P-E005 (3-Pin Connector) (16 AWG)*
	WA = 4.5-inch Cable w/Blade Terminals 6,3 mm x 0,8 mm (16 AWG)*
	XA = 10-inch Cable w/ Metripack 2-Pin Shroud Connector 153000027 (18 AWG)
	YA = 6-inch Cable w/Amp Super Seal 1.5 - 282104-1 (2-Pin Connector) (18 AWG)*
	ZA = 10-inch Cable w/Deutsch DT06-2S-CE06 (2-Socket Connector) (18 AWG)
	AB = Deutsch DT04-2P-E005 (2-Pin Connector)
	BB = 10-inch Cable w/Metripack 150 Delphi 12129615 (3-Pin Connector) (18 AWG)*
	CB = 6-inch Cable w/ AMP Super Seal 1.5 - 282080-1 (2-Pin Connector) (18 AWG)
DB = 10-inch Cable w/AMP 2,5 mm System Series Connector 1-967402-1 (18 AWG)*	
EB = 4.5-inch Cable w/Packard Shroud Connector 12015792 (2-Pin Connector) (18 AWG)	
FB = 10-inch Cable w/Metripack 150 Delphi 12052641 (2-Pin Connector) (18 AWG)	
GB = 8.5-inch Cable w/Deutsch Plug HD 16-3 96S (3-Pin Connector) (16 AWG)	
MH	AA = Spade Terminals
	BA = Screw Terminals
	DA = Amp Super Seal 1.5 - 282105-1 (3-Pin Connector)
	EA = 10-inch Cable, 18 AWG (Wire Out, No Connector)
	HA = 10-inch Cable w/Metripack 280 Delphi 15300002 (2-Pin Connector) (18 AWG)*
	MA = 10-inch Cable w/Deutsch DT04-2P-E005 (2-Pin Connector) (18 AWG)
	NA = 3-inch Cable w/Packard 2P Tower Connector - 12015792 (2-Pin Connector) (18 AWG)
	PA = 2.75-inch Cable w/Packard 2P Shroud Connector - 12010973 (2-Pin Connector) (18 AWG)
	RA = 4-inch Cable w/Packard 2P Shroud Connector - 12010973 (2-Pin Connector) (16 AWG)
	SA = 5.5-inch Cable w/ITT Cannon 2P Sure-Seal Circular Connector - SS2R-120-1804-000 (2-Pin Connector) (18 AWG)
	WA = 4.5-inch Cable w/Blade Terminals 6,3 mm x 0,8 mm (16 AWG)*
	XA = 10-inch Cable w/ Metripack 2-Pin Shroud Connector 153000027 (18 AWG)
	YA = 6-inch Cable w/Amp Super Seal 1.5 - 282104-1 (2-Pin Connector) (18 AWG)*
	ZA = 10-inch Cable w/Deutsch DT06-2S-CE06 (2-Socket Connector) (18 AWG)
	AB = Deutsch DT04-2P-E005 (2-Pin Connector)
CB = 6-inch Cable w/ AMP Super Seal 1.5 - 282080-1 (2-Pin Connector) (18 AWG)	
DB = 10-inch Cable w/AMP 2,5 mm System Series Connector 1-967402-1 (18 AWG)*	
EB = 4.5-inch Cable w/Packard Shroud Connector 12015792 (2-Pin Connector) (18 AWG)	
FB = 10-inch Cable w/Metripack 150 Delphi 12052641 (2-Pin Connector) (18 AWG)	

*These connectors are designed for dual circuit (SPDT) by default. They can be used for single-circuit applications (SPNC/SPNO) by making suitable connections. Refer to wiring diagram.

HONEYWELL PRESSURE SWITCHES HP, HE, MH, ME, LP AND LE SERIES

Issue E
50038194

DIMENSIONS - HIGH PRESSURE: HP SERIES (BASE STYLE A), HE SERIES

Base Style A key specifications • Life: 2 million (HP), 1 million (HE); Burst pressure: 20,000 psi

Figure 1. AMP Superseal 1.5

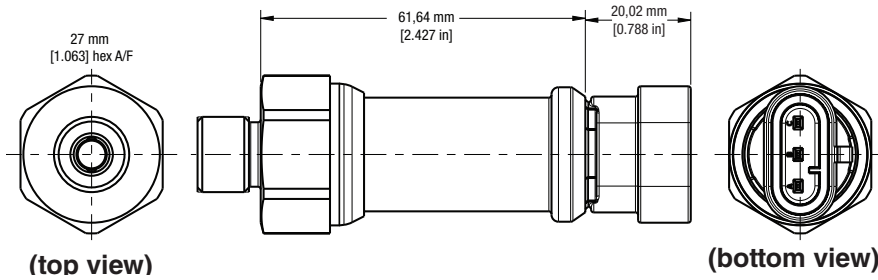

Female Connector Part Number (included): C-282105
Male Mating Connector (customer provided): C-282087
IP Rating: IP67

Figure 2. Deutsch

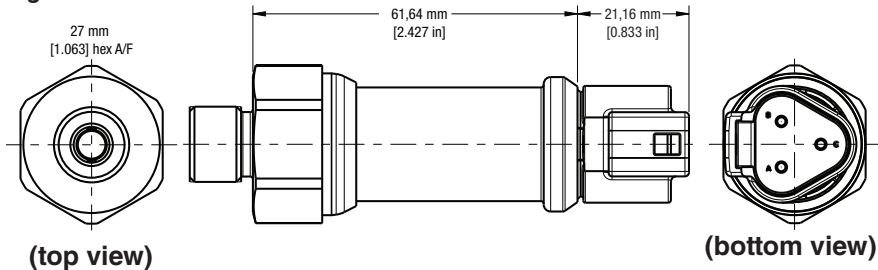

Female Connector Part Number (included): DT04-3P
Male Mating Connector (customer provided): DT06-3S
IP Rating: IP67

Figure 3. Spade Terminal

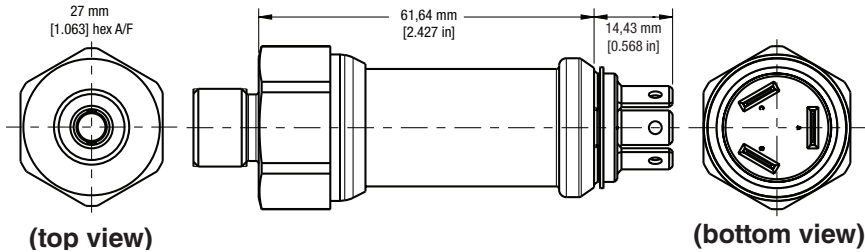

Figure 4. Screw Terminal

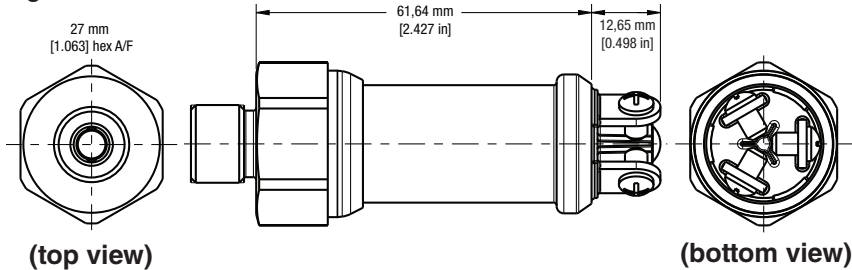
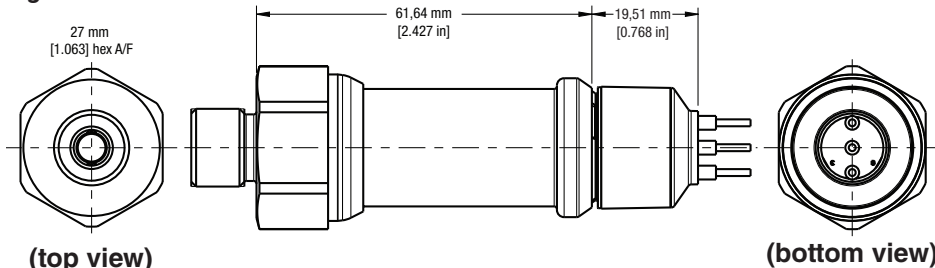

Figure 5. Cable



IP Rating: IP67

HONEYWELL PRESSURE SWITCHES HP, HE, MH, ME, LP AND LE SERIES

Issue E
50038194

DIMENSIONS - HIGH PRESSURE: HP SERIES (BASE STYLE B)

Base Style B key specifications • Life: 1 million; Burst pressure: 9,000 psi

Figure 6. HP Series Smaller Port

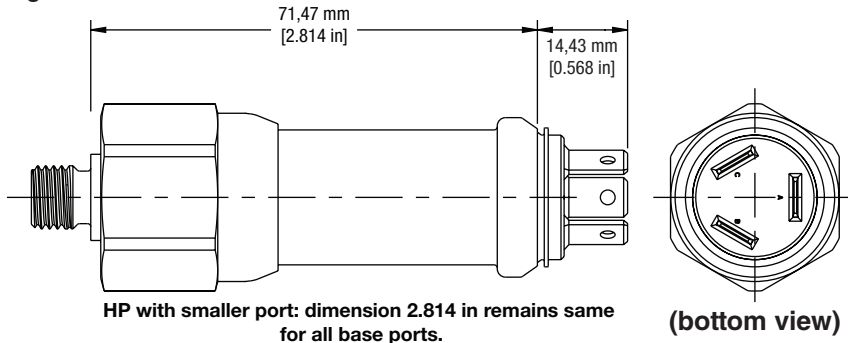

Figure 7. HP Series Pressure Port Dimensions

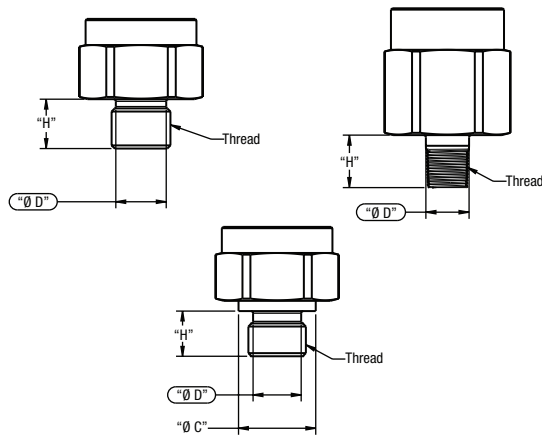

TABLE 3. HP/HE SERIES PRESSURE PORT DIAMETERS AND HEIGHTS

Nomenclature Code	Thread	Height "A"	Diameter "ØD"	Diameter "ØC"	Height "H"
M	7/16-20 UNF	–	9,25 mm [0.364 in]	–	11 mm [0.433 in]
C ¹	1/2-20 UNF	–	10,85 mm [0.427 in]	–	11 mm [0.433 in]
G ²	9/16-18 UNF	–	12,24 mm [0.482 in]	–	12 mm [0.472 in]
H	3/4-16 UNF	–	16,74 mm [0.66 in]	–	14 mm [0.551 in]
N	7/8-14 UNF	–	19,6 mm [0.773 in]	–	16 mm [0.630 in]
T	M10 x 1.0	1,60 mm [0.063 in]	9,25 mm [0.364 in]	13,79 mm [0.543 in]	11 mm [0.433 in]
E	M12 x 1.5	2,48 mm [0.098 in]	10,85 mm [0.427 in]	16,79 mm [0.661 in]	11 mm [0.433 in]
F ²	M14 x 1.5	2,48 mm [0.098 in]	12,24 mm [0.482 in]	18,8 mm [0.74 in]	12 mm [0.472 in]
K	M18 x 1.5	2,48 mm [0.098 in]	16,74 mm [0.66 in]	23,8 mm [0.937 in]	14 mm [0.551 in]
B	1/8-27 NPT	–	10,29 mm [0.405 in]	–	12,497 mm [0.492 in]
A	1/4-18 NPT	–	13,72 mm [0.540 in]	–	17,63 mm [0.694 in]

¹Port Style C: Switches less than 975 psi will use Base Style B; switches greater than 975 psi will use Base Style A.

²Port Styles F and G: Switches less than 350 psi will use Base Style B; switches greater than 350 psi will use Base Style A. Switches less than 150 psi will use only Base Style B.

DIMENSIONS - MEDIUM PRESSURE: MH SERIES

Figure 8. AMP Superseal 1.5

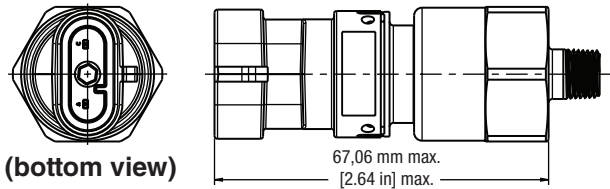

Figure 9. Deutsch 3-pin

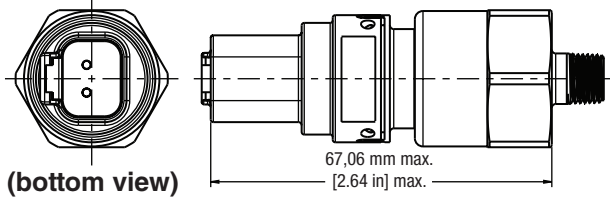

Figure 10. Wire out

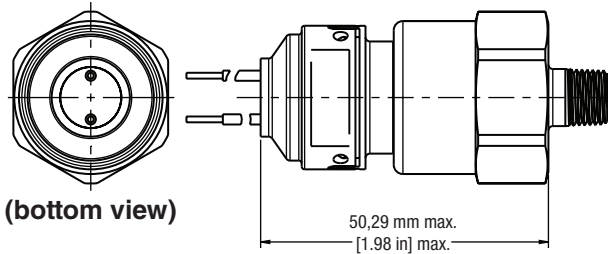

Figure 11. Blade terminal

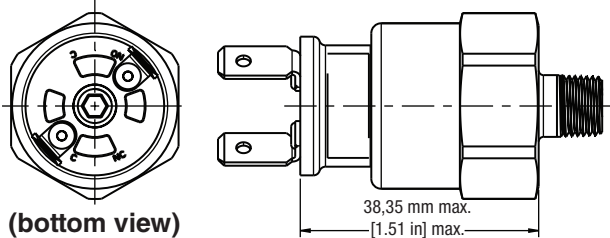

Figure 12. Screw terminal

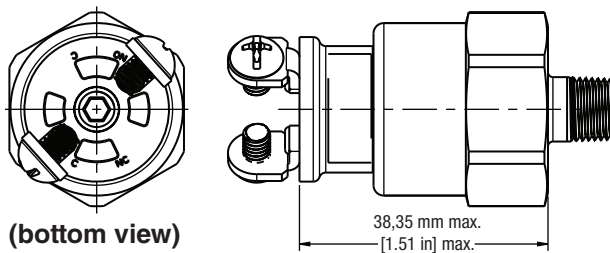

Figure 13. MH Series Pressure Port Dimensions

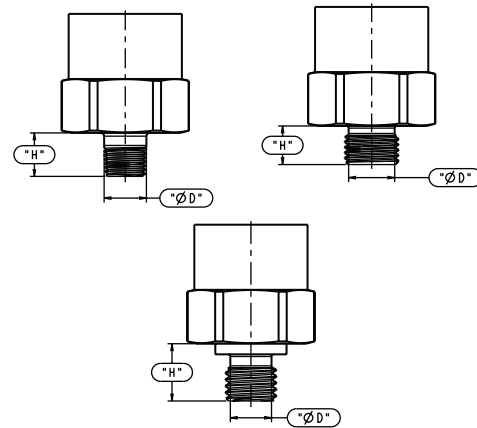

TABLE 4. MH SERIES PRESSURE PORT DIAMETERS AND HEIGHTS

Port	Diameter "ØD"	Height "H"
R 1/2 BSPT	21,34 mm [0.840 in]	17,09 mm [0.673 in]
R 1/4 BSPT	13,46 mm [0.530 in]	13,74 mm [0.541 in]
R 1/8 BSPT	9,96 mm [0.392 in]	10,24 mm [0.403 in]
1/8-27 PTF	10,34 mm [0.407 in]	9,24 mm [0.364 in]
1/4-18 NPT	13,72 mm [0.540 in]	17,63 mm [0.694 in]
1/8-27 NPT	10,29 mm [0.405 in]	12,497 mm [0.492 in]
G 1/4 BSPP	11,1 mm [0.437 in]	11,20 mm [0.441 in]
G 1/8 BSPP	8,28 mm [0.326 in]	7,59 mm [0.299 in]
3/4-16 UNF	16,74 mm [0.659 in]	11,1 mm [0.437 in]
7/16-20 UNF	9,25 mm [0.364 in]	9,09 mm [0.358 in]
9/16-18 UNF	12,24 mm [0.482 in]	10,00 mm [0.394 in]
1/2-20 UNF	10,85 mm [0.427 in]	9,09 mm [0.358 in]

Port	Height "A"	Diameter "ØC"	Diameter "ØD"	Height "H"
M14 × 1.5	2,49 mm [0.098 in]	18,8 mm [0.74 in]	11,71 mm [0.461 in]	10,998 mm [0.433 in]
M12 × 1.5	2,49 mm [0.098 in]	16,79 mm [0.661 in]	9,70 mm [0.382 in]	10,998 mm [0.433 in]
M10 × 1.0	1,6 mm [0.063 in]	13,79 mm [0.543 in]	8,41 mm [0.331 in]	8,51 mm [0.335 in]

DIMENSIONS - MEDIUM PRESSURE: ME SERIES

Figure 14. AMP Superseal 1.5

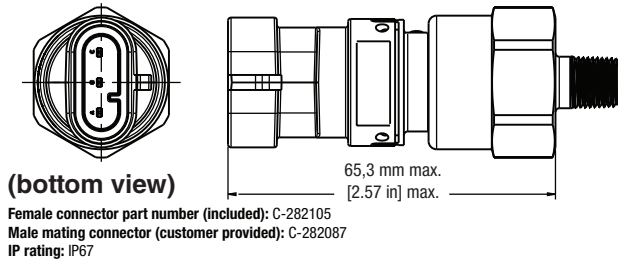

Figure 15. Deutsch 3-pin

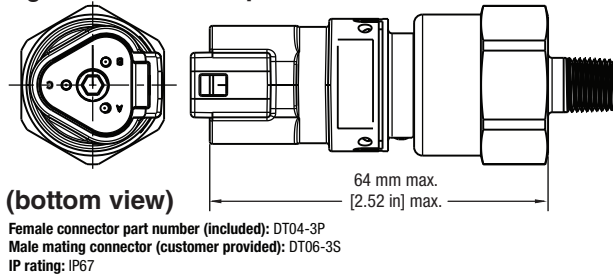

Figure 16. Deutsch 2-pin

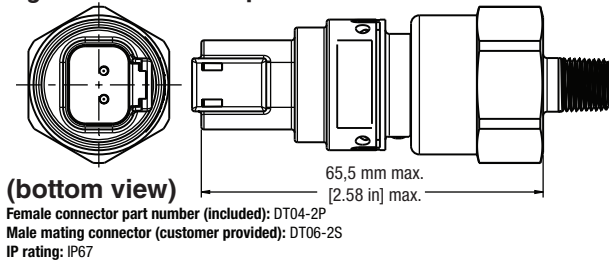

Figure 17. Wire out

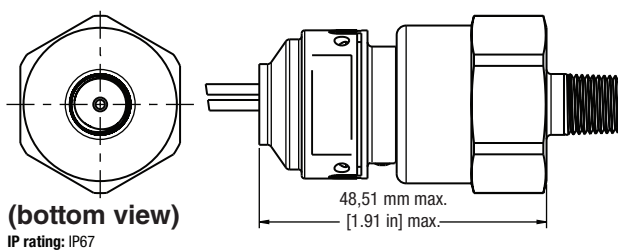

Figure 18. Blade terminal

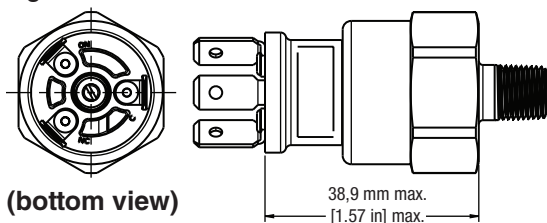

Figure 19. Screw terminal

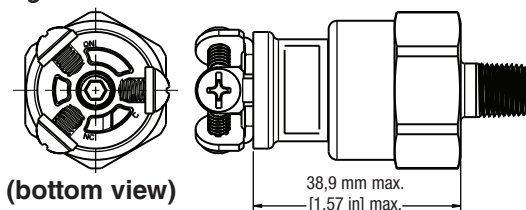

Figure 20. ME Series Pressure Port Dimensions

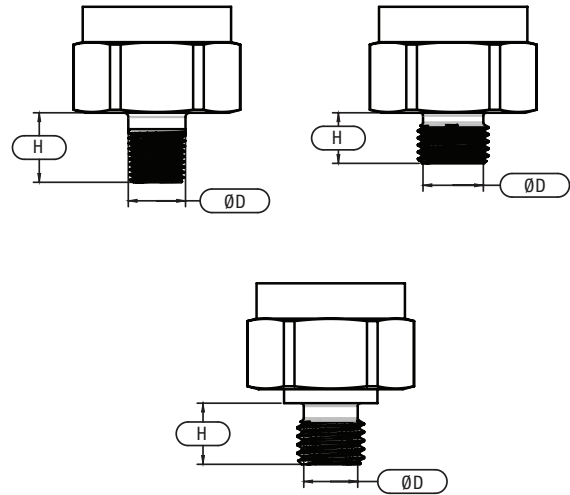

TABLE 5. ME SERIES PRESSURE PORT DIAMETERS AND HEIGHTS

Port	Diameter "ØD"	Height "H"
R 1/2 BSPT	21,34 mm [0.840 in]	17,09 mm [0.673 in]
R 1/4 BSPT	13,46 mm [0.530 in]	13,74 mm [0.541 in]
R 1/8 BSPT	9,96 mm [0.392 in]	10,24 mm [0.403 in]
1/8-27 PTF	10,34 mm [0.407 in]	9,24 mm [0.364 in]
1/4-18 NPT	13,72 mm [0.540 in]	17,63 mm [0.694 in]
1/8-27 NPT	10,29 mm [0.405 in]	12,497 mm [0.492 in]
G 1/4 BSPP	11,1 mm [0.437 in]	11,20 mm [0.441 in]
G 1/8 BSPP	8,28 mm [0.326 in]	7,59 mm [0.299 in]
3/4-16 UNF	16,74 mm [0.659 in]	11,1 mm [0.437 in]
7/16-20 UNF	9,25 mm [0.364 in]	9,09 mm [0.358 in]
9/16-18 UNF	12,24 mm [0.482 in]	10,00 mm [0.394 in]
1/2-20 UNF	10,85 mm [0.427 in]	9,09 mm [0.358 in]

Port	Height "A"	Diameter "ØC"	Diameter "ØD"	Height "H"
M14 × 1.5	2,49 mm [0.098 in]	18,8 mm [0.74 in]	11,71 mm [0.461 in]	10,998 mm [0.433 in]
M12 × 1.5	2,49 mm [0.098 in]	16,79 mm [0.661 in]	9,70 mm [0.382 in]	10,998 mm [0.433 in]
M10 × 1.0	1,6 mm [0.063 in]	13,79 mm [0.543 in]	8,41 mm [0.331 in]	8,51 mm [0.335 in]

DIMENSIONS - LOW PRESSURE: LP SERIES, LE SERIES

Figure 21. AMP Superseal 1.5

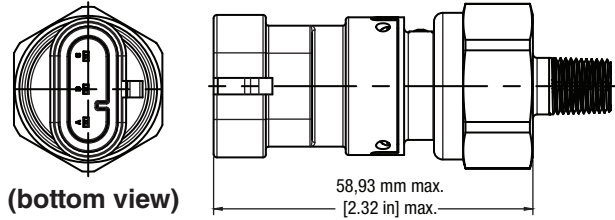

Figure 22. Deutsch 3-pin

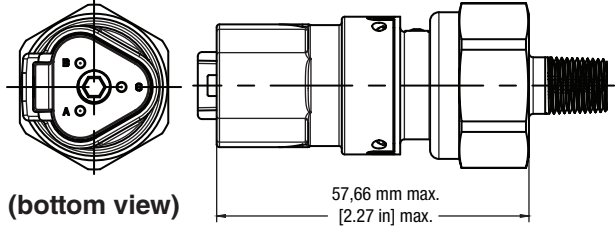

Figure 23. Deutsch 2-pin

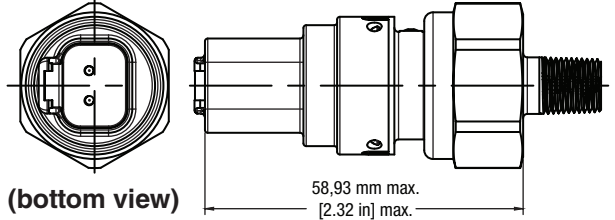

Figure 24. Wire out

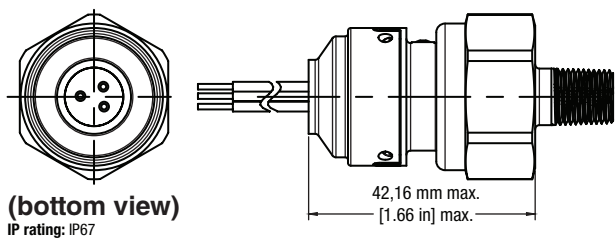

Figure 25. Spade terminal

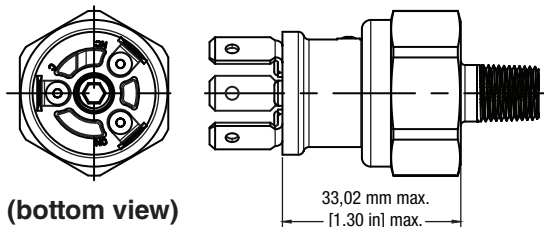

Figure 26. Screw terminal

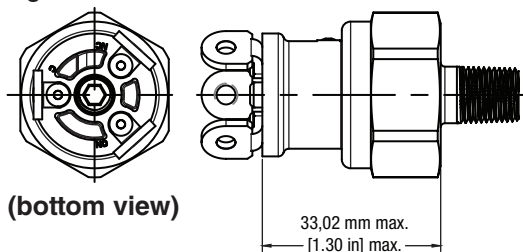

Figure 27. LP/LE Series Pressure Port Dimensions

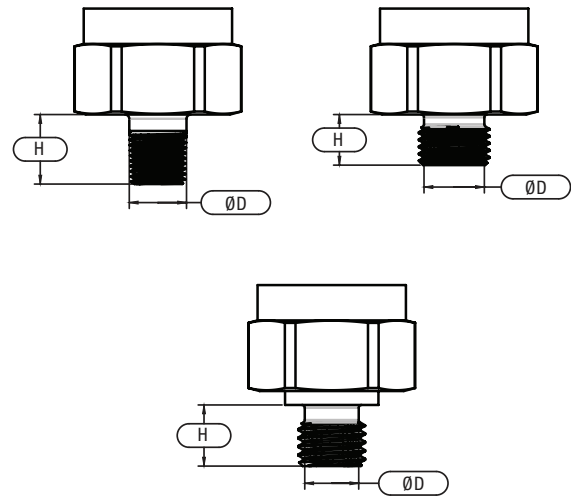

TABLE 6. LP/LE SERIES PRESSURE PORT DIAMETERS AND HEIGHTS

Port	Diameter "ØD"	Height "H"
R 1/2 BSPT	21,34 mm [0.840 in]	17,09 mm [0.673 in]
R 1/4 BSPT	13,46 mm [0.530 in]	13,74 mm [0.541 in]
R 1/8 BSPT	9,96 mm [0.392 in]	10,24 mm [0.403 in]
1/8-27 PTF	10,34 mm [0.407 in]	9,24 mm [0.364 in]
1/4-18 NPT	13,72 mm [0.540 in]	17,63 mm [0.694 in]
1/8-27 NPT	10,29 mm [0.405 in]	12,497 mm [0.492 in]
G 1/4 BSPP	11,1 mm [0.437 in]	11,20 mm [0.441 in]
G 1/8 BSPP	8,28 mm [0.326 in]	7,59 mm [0.299 in]
3/4-16 UNF	16,74 mm [0.659 in]	11,1 mm [0.437 in]
7/16-20 UNF	9,25 mm [0.364 in]	9,09 mm [0.358 in]
9/16-18 UNF	12,24 mm [0.482 in]	10,00 mm [0.394 in]
1/2-20 UNF	10,85 mm [0.427 in]	9,09 mm [0.358 in]

Port	Height "A"	Diameter "ØC"	Diameter "ØD"	Height "H"
M14 × 1.5	2,49 mm [0.098 in]	18,8 mm [0.74 in]	11,71 mm [0.461 in]	10,998 mm [0.433 in]
M12 × 1.5	2,49 mm [0.098 in]	16,79 mm [0.661 in]	9,70 mm [0.382 in]	10,998 mm [0.433 in]
M10 × 1.0	1,6 mm [0.063 in]	13,79 mm [0.543 in]	8,41 mm [0.331 in]	8,51 mm [0.335 in]

Figure 28. HP, HE, MH, ME, LP, LE Wiring Diagrams

AA & BA

Screw and blade versions

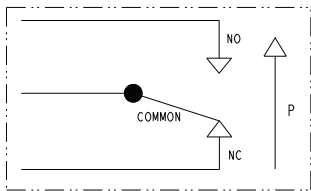

SPDT

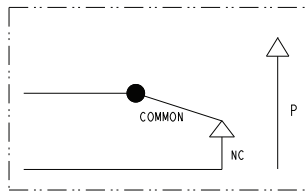

SPNC

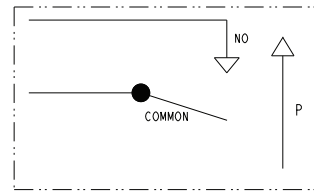

SPNO

CA

Deutsch 3-pin connector version

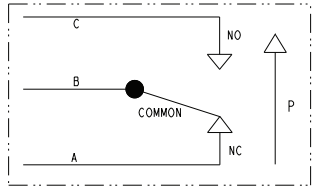

SPDT

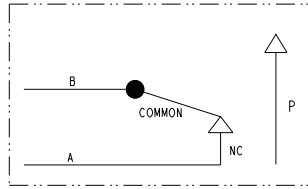

SPNC

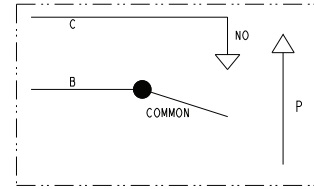

SPNO

DA

AMP connector version

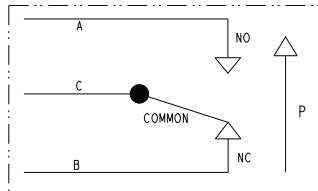

SPDT

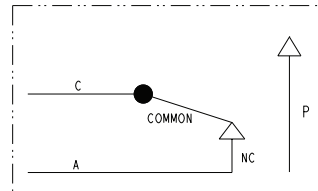

SPNC

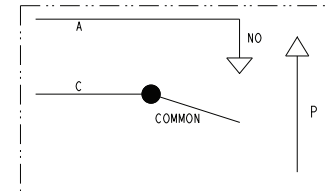

SPNO

EA

Wire-out version

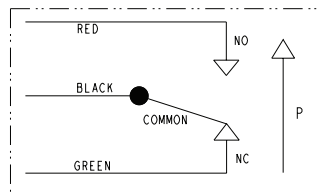

SPDT

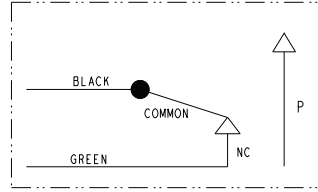

SPNC

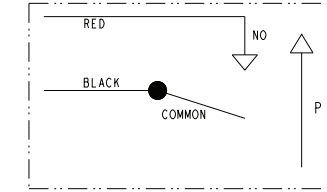

SPNO

FA, UA, VA, GB

Various connector versions

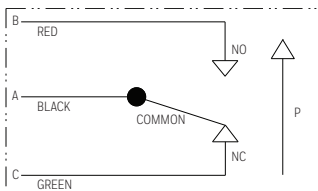

SPDT

GA, KA, LA, BB

Various connector versions

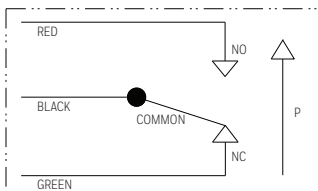

SPDT

HA, MA, NA, PA, RA, SA, XA, YA, ZA, AB, CB, EB, FB

various versions

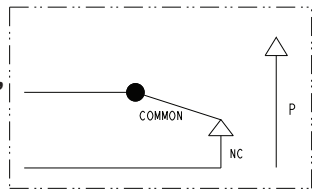

SPNC

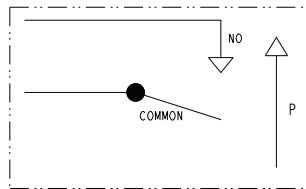

SPNO

Figure 28. HP, HE, MH, ME, LP, LE Wiring Diagrams, continued

JA
 DIN43650-C
 connector version

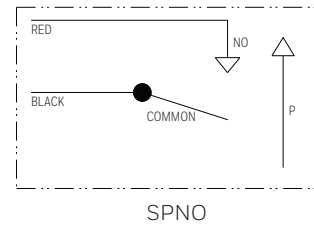
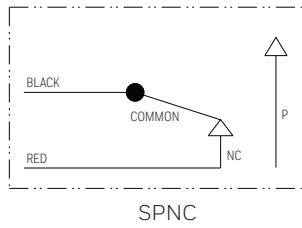
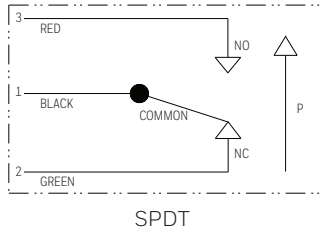

TA
 ITT-Cannon 3P
 circular connector
 version

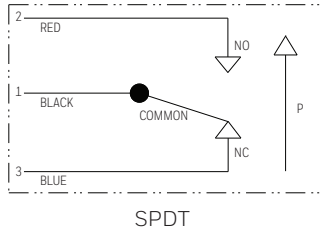

WA
 Cable with
 blade version

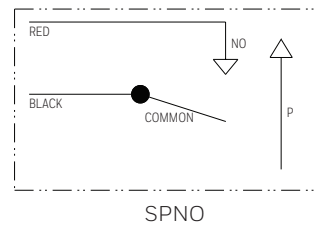
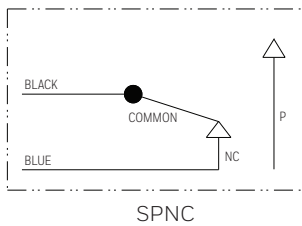
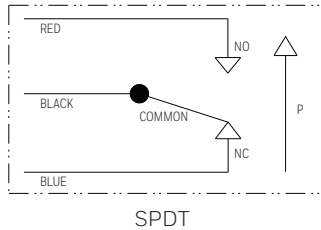

DB
 Cable with AMP
 2,5 mm System
 connector version

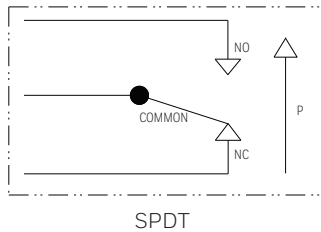

WARRANTY/REMEDY

Honeywell warrants goods of its manufacture as being free of defective materials and faulty workmanship during the applicable warranty period. Honeywell's standard product warranty applies unless agreed to otherwise by Honeywell in writing; please refer to your order acknowledgment or consult your local sales office for specific warranty details. If warranted goods are returned to Honeywell during the period of coverage, Honeywell will repair or replace, at its option, without charge those items that Honeywell, in its sole discretion, finds defective.

The foregoing is buyer's sole remedy and is in lieu of all other warranties, expressed or implied, including those of merchantability and fitness for a particular purpose. In no event shall Honeywell be liable for consequential, special, or indirect damages.

While Honeywell may provide application assistance personally, through our literature and the Honeywell web site, it is buyer's sole responsibility to determine the suitability of the product in the application.

Specifications may change without notice. The information we supply is believed to be accurate and reliable as of this writing. However, Honeywell assumes no responsibility for its use.

FOR MORE INFORMATION

Honeywell Sensing and Safety Technologies services its customers through a worldwide network of sales offices and distributors. For application assistance, current specifications, pricing or the nearest Authorized Distributor, visit our [website](#) or call:

USA/Canada	+1 302 613 4491
Latin America	+1 305 805 8188
Europe	+44 1344 238258
Japan	+81 (0) 3-6730-7152
Singapore	+65 6355 2828
Greater China	+86 4006396841

Honeywell
Sensing and Safety Technologies
830 East Arapaho Road
Richardson, TX 75081
[honeywell.com](#)

® DuPont™, Teflon®, Tefzel®, and Kapton® are trademarks or registered trademarks of E.I. du Pont de Nemours and Company

50038194-E-EN | E | 10/22
© 2022 Honeywell International Inc. All rights reserved.

WARNING **PERSONAL INJURY**

DO NOT USE these products as safety or emergency stop devices or in any other application where failure of the product could result in personal injury.

Failure to comply with these instructions could result in death or serious injury.

WARNING

Honeywell does not recommend using devices for critical control applications where there is, or may be, a single point of failure or where single points of failure may result in an unsafe condition. It is up to the end-user to weigh the risks and benefits to determine if the products are appropriate for the application based on security, safety and performance. Additionally, it is up to the end-user to ensure that the control strategy results in a safe operating condition if any crucial segment of the control solution fails. Honeywell customers assume full responsibility for learning and meeting the required Declaration of Conformity, Regulations, Guidelines, etc. for each country in their distribution market.

Honeywell