

## Technical Note

# Entering and Using Command Mode on the Honeywell HumidCon™ Digital Humidity/Temperature Sensors

### 1.0 Introduction

Command Mode is used on the Honeywell HumidCon™ Digital Humidity/Temperature Sensors for reading and writing to the on-chip EEPROM. Command Mode allows the user to configure and optimize sensor performance to match application requirements. User-configurable options include alarm settings, I<sup>2</sup>C address and customer identification bytes.

This document describes:

- How to enter Command Mode.
- How to use Command Mode to configure the sensor.
- An example of the required configuration steps.

### 2.0 Power-On Sequence

Figure 1 shows the Power-On sequence.

**Figure 1. Power-On Sequence with a 3 ms Command Window**

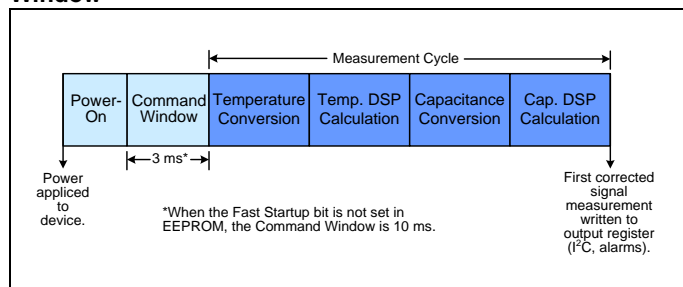

After Power-On, the Command Window is entered. The Command Window can be configured to be either 3 ms or 10 ms in duration (see Section 4.1). If the sensor receives a “Start\_CM” command during the Command Window, it enters and remains in Command Mode.

While the sensor is in Command Mode it communicates as an I<sup>2</sup>C device regardless of its preconfigured output protocol. The sensor clock pin becomes the I<sup>2</sup>C clock pin (SCL) and the sensor data pin becomes the I<sup>2</sup>C data pin (SDA).

If, during the Power-On sequence, the Command Window expires without receiving a “Start\_CM” command, or if the sensor receives a “Start\_NOM” command in Command Mode, the sensor will immediately revert to its pre-configured output protocol (either I<sup>2</sup>C or SPI), perform one complete measurement cycle and write the data to the output registers before entering into sleep mode (see Figure 2).

**Figure 2. General Operation Flow Chart**

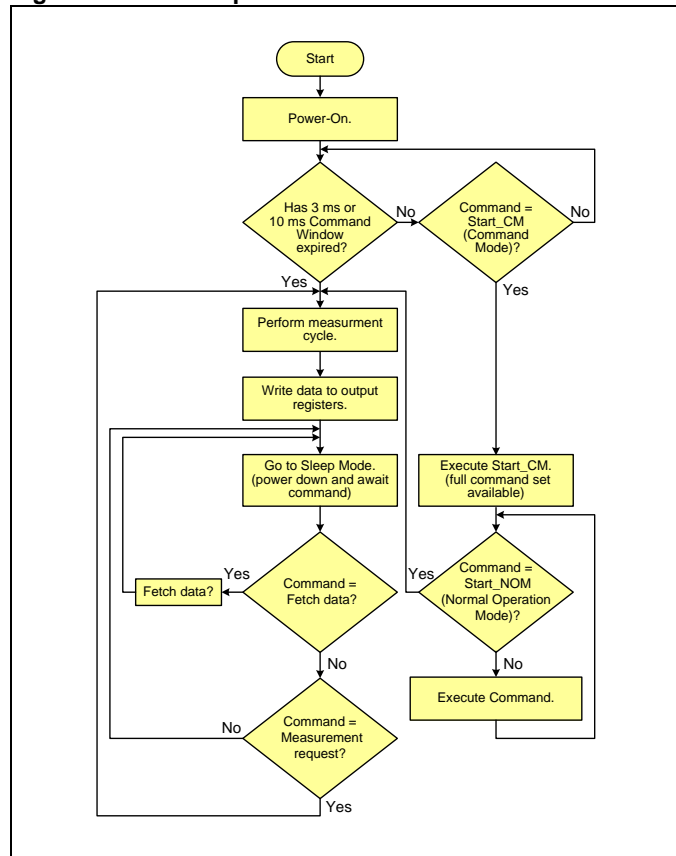

### 3.0 Command Mode

Command Mode is used for configuring the sensor. It is entered by sending a “Start\_CM” command during the Command Window (see Section 2.0). In Command Mode a set of commands is available to the user to configure the sensor (see Table 1). All communication in Command Mode is done using I<sup>2</sup>C protocol regardless of the preconfigured communications protocol of the sensor.

#### 3.1 Command Format

Command Mode commands are supported only for the I<sup>2</sup>C protocol. As shown in Figure 3, commands consist of 4-byte packets with the first byte being a 7-bit slave address followed by a Read/Write bit (0 = Write, 1 = Read). The second byte is the command byte, and the last two bytes form a 16-bit data field.

# Entering and Using Command Mode on the Honeywell HumidCon™ Digital Humidity/Temperature Sensors

Figure 3. Command Mode Format

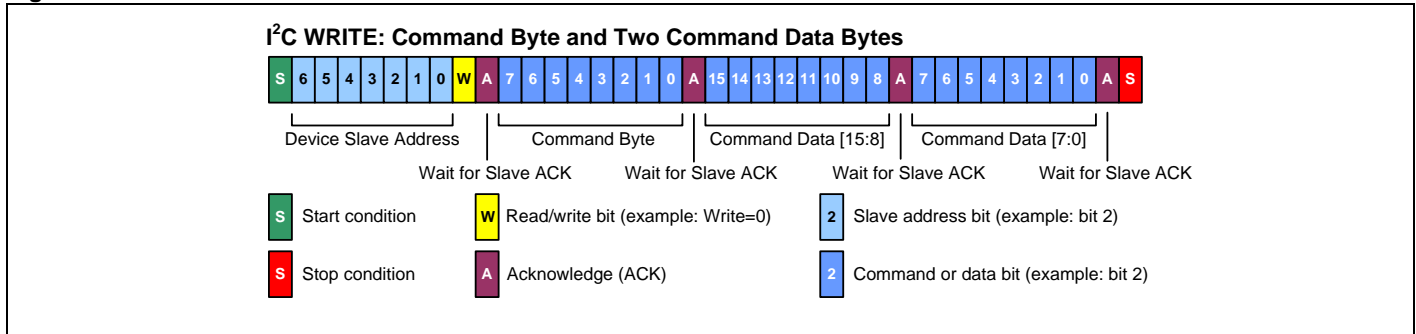

## 3.2 Command Mode Commands

Table 1 lists all the commands that are available in Command Mode.

**Note:** Only the commands listed in Table 1 are valid. Other encodings may cause unpredictable behavior. If data is not needed for the command, zeros must be supplied in the data field to complete the 4-byte packet.

Table 1. Command Mode Commands

Command Byte (8-bits, Hex)	Data Bytes (16-bits, Hex)	Description	Response Time
0x00 to 0x1F	0x0000	<b>EEPROM Read of address 0x00 to 0x1F</b>  after this command has been sent and executed, a data fetch must be performed to retrieve the contents of the EEPROM address is specified in the six LSBs of the command byte	100 $\mu$ s
0x40 to 0x5F	0xYYYY (Y=data)	<b>Write to EEPROM addresses 0x00 to 0x1F</b>  the two data bytes sent will be written to the address specified in the six LSBs of the command byte	12 ms
0x80	0x0000	<b>Start_NOM</b>  ends Command Mode and transitions to Normal Operation Mode	42.5 ms
0xA0	0x0000	<b>Start_CM</b>  starts Command Mode: used to enter Command Mode, is only valid during the Power-On command window (see Section 2.0)	100 $\mu$ s

**Note:** All time values are typical; for worst case values, add 15%.

## 3.3 Command response and Data Fetch Format

After a command has been sent and its execution time defined in Table 1 has expired, an I<sup>2</sup>C Data Fetch is used to read the response.

Figure 4 shows the different Data Fetch formats. After the slave address has been sent, the first byte fetched is the response byte. The response byte consists of two status bits, four diagnostic bits and two response bits.

The upper two bits of the response byte are the status bits. Table 2 describes the conditions that the status bits can report.

The middle four bits of the response byte are command diagnostic bits. Each bit represents a different diagnostic (see Table 3).

The lower two bits of the response byte are the response bits. To determine if a command has finished executing, poll the device until a "Busy" response is no longer received. Table 4 describes the different responses that the sensor can return.

### NOTICE

- Regardless of what the response bits are, one or more of the diagnostic bits may be set indicating an error has occurred during the execution of the command.
- Only one command may be executed at a time. After a command is sent, another command must not be sent until the execution time of the first command has expired. Alternatively the response bits can be polled to determine when the command has completed execution.

# Entering and Using Command Mode on the Honeywell HumidCon™ Digital Humidity/Temperature Sensors

Figure 4. Command Mode Data Fetch Formats

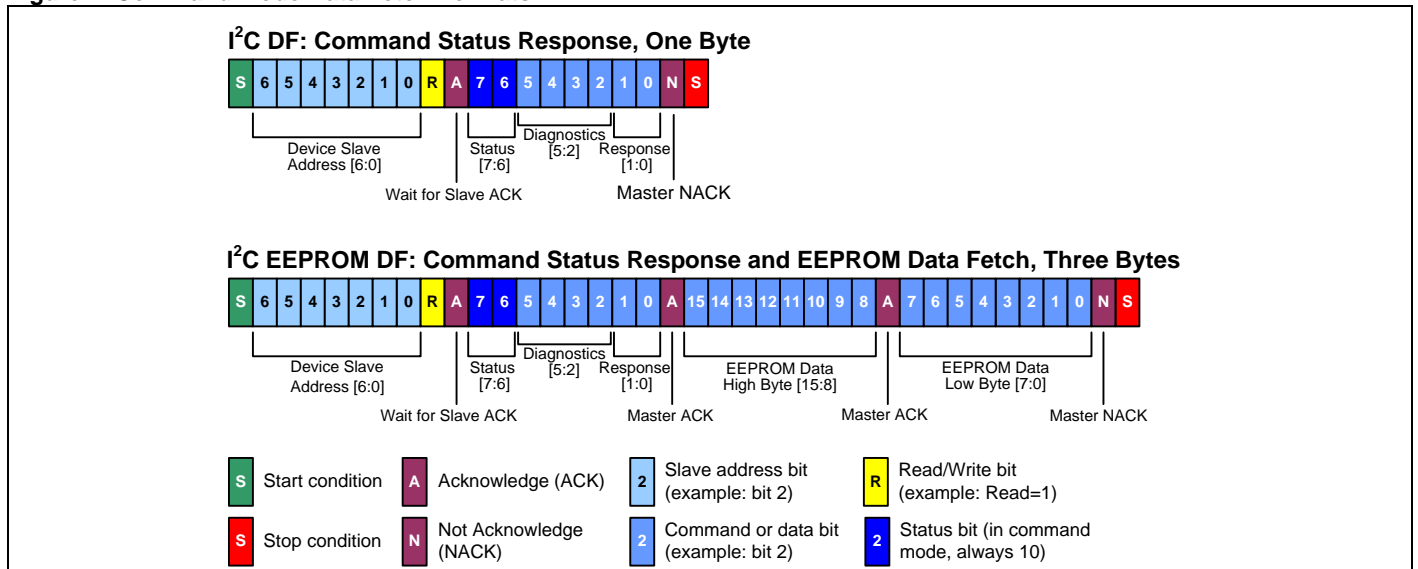

Table 2. Status Bits

Status Bits		Definition
S1	S0	
0	0	normal operation, valid data
0	1	stale data: data that has already been fetched since the last measurement cycle, or data fetched before the first measurement cycle has been completed
1	0	device in Command Mode
1	1	not used

Table 3. Diagnostic Bits

Diagnostic Bits				Name	Description
D3	D2	D1	D0		
x	x	x	1	corrected EEPROM error	a corrected EEPROM error occurred during the execution of the last command
x	x	1	x	uncorrectable EEPROM error	an uncorrectable EEPROM error occurred during the execution of the last command
x	1	x	x	RAM parity error	a RAM parity error occurred during the execution of the last command
1	x	x	x	configuration error	an EEPROM or RAM parity error occurred during the initial loading of the configuration registers

Table 4. Response Bits

Response Bits		Definition	Description
R1	R0		
0	0	busy	the command is still executing
0	1	positive acknowledge	the command executed successfully
1	0	negative acknowledge	the command was not recognized or an EEPROM write was attempted to a locked EEPROM location
1	1	not used	

## 4.0 EEPROM

The EEPROM array contains the configuration bits for the I<sup>2</sup>C slave address, alarms, Command Window duration and customer identification. The EEPROM is organized as 32 16-bit words (see Table 5). The EEPROM is divided into two sections:

- EEPROM locations 0x00 to 0x15 are locked and can no longer be written to.
- EEPROM locations 0x16 to 0x1F are unlocked and may be modified by the customer.

### NOTICE

Any modifications to EEPROM locations require a power cycle for the changes to take effect.

# Entering and Using Command Mode on the Honeywell HumidCon™ Digital Humidity/Temperature Sensors

Table 5. EEPROM Memory Map

EEPROM Address	Name	Description
0x00 to 0x15	reserved	<b>do not change</b> ; must be left at factory settings; locked EEPROM locations
0x16	reserved	<b>do not change</b> ; must be left at factory settings
0x17	reserved	<b>do not change</b> ; must be left at factory settings
0x18	Alarm_High_On	high alarm on trip point
0x19	Alarm_High_Off	high alarm off trip point
0x1A	Alarm_Low_On	low alarm on trip point
0x1B	Alarm_Low_Off	low alarm off trip point
0x1C	Cust_Config	Customer Configuration Register (see Section 4.1)
0x1D	reserved	<b>do not change</b> ; must be left at factory settings
0x1E	Cust_ID2	customer ID word: for use by customer
0x1F	Cust_ID3	customer ID word: for use by customer

## 4.1 Customer Configuration Register

The Customer Configuration Register (see table 6) is located at EEPROM location 0x1C. The register is loaded at Power-On.

## 5.0 Digital Humidity/Temperature Sensor Configuration Example

Command Mode is used to configure Honeywell digital humidity/temperature sensors. A few basic steps and I<sup>2</sup>C communications are all that is required for a user to optimize the sensor for the application.

Figure 5 shows the steps required to enable a digital humidity sensor in the configuration described below:

- Alarm\_High\_On = 80% humidity
- Alarm\_Low\_On = 20% humidity
- Alarm\_High\_Off = 75% humidity
- Alarm\_Low\_Off = 25% humidity
- I<sup>2</sup>C Address = 0x53
- Command Window = 3 ms
- Alarm\_High = Active\_High
- Alarm\_Low = Active\_High
- Alarm\_High = Full\_Push-Pull Output
- Alarm\_Low = Full\_Push-Pull Output

Table 6. Customer Configuration Register

Bit	Name	Description
6:0	Device ID	I <sup>2</sup> C slave address
8:7	Alarm_Low_Cfg	configures the Alarm_Low output pin
		<b>Bit</b>   <b>Description</b>
		7   alarm polarity: 0 = Active_High 1 = Active_Low
	8	output configuration: 0 = Full_Push-Pull 1 = Open_Drain
10:9	Alarm_High_Cfg	Configures the Alarm_High output pin
		<b>Bit</b>   <b>Description</b>
		9   alarm polarity: 0 = Active_High 1 = Active_Low
	10	output configuration: 0 = Full_Push-Pull 1 = Open_Drain
11	reserved	<b>do not change</b> ; must be left at factory setting
12	reserved	<b>do not change</b> ; must be left at factory setting
13	fast startup	sets the Command Window duration: 0 = 10 ms, 1 = 3 ms
15:14	reserved	<b>do not change</b> ; must be left at factory setting

## NOTICE

Read and store the original EEPROM contents before modifying them in case the sensor must be returned to its default condition.

# Entering and Using Command Mode on the Honeywell HumidCon™ Digital Humidity/Temperature Sensors

Figure 5. Digital Humidity/Temperature Sensor Configuration Steps

Step 1. Power-on.

Step 2. Within 3 ms or 10 ms of Power-on, set device to Command Mode.

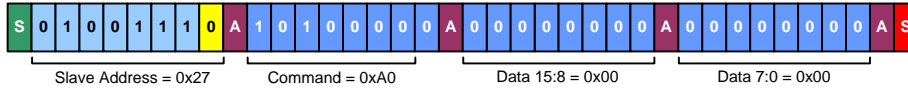

Step 3. Read EEPROM Location 0x18.

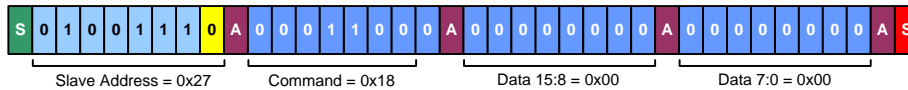

Step 4. Perform Data Fetch to retrieve contents of EEPROM location 0x18.

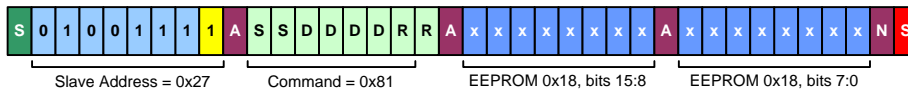

Step 5. Repeat Steps 3 and 4 for EEPROM locations 0x19, 0x1B and 0x1C.

Step 6. Set Alarm\_High\_On = 80% Humidity. (Write 0x3333 to EEPROM Location 0x18).

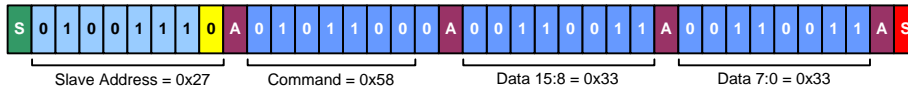

Step 7. Set Alarm\_High\_Off = 75% Humidity. (Write 0x3000 to EEPROM Location 0x19).

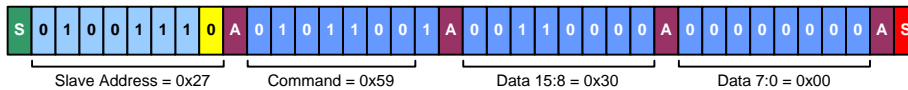

Step 8. Set Alarm\_Low\_On = 20% Humidity. (Write 0x0CCD to EEPROM Location 0x1A).

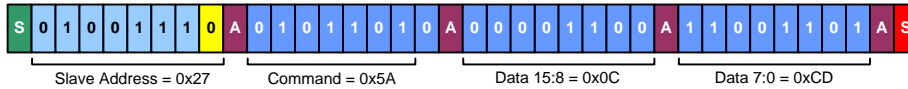

Step 9. Set Alarm\_Low\_Off = 25% Humidity. (Write 0x1000 to EEPROM Location 0x1B).

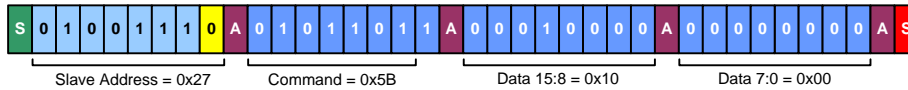

Step 10. Set I<sup>2</sup>C Address = 0x53 (Write Bits 6:0 of Customer Configuration Register = 0b1010011)

Make Alarm\_Low = Active High (Write Bit 7 of Customer Configuration Register = 0).

Make Alarm\_Low = Push-Pull (Write Bit 8 of Customer Configuration Register = 0).

Make Alarm\_High = Active High (Write Bit 9 of Customer Configuration Register = 0).

Make Alarm\_High = Push-Pull (Write Bit 10 of Customer Configuration Register = 0).

Make Command Window = 3 ms (Write Bit 13 of Customer Configuration Register = 1).

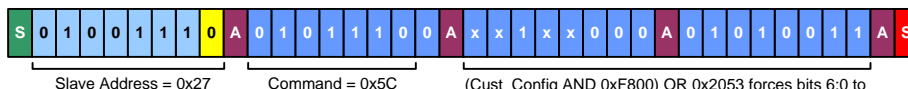

Step 11. Power-off.

Step 12. Power-on. New configuration is now in effect.

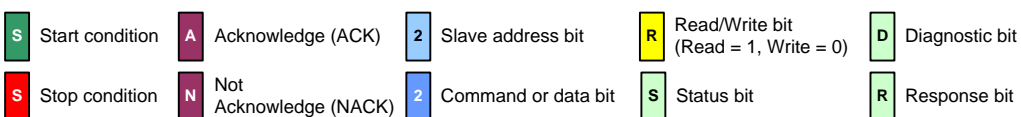

# Entering and Using Command Mode on the Honeywell HumidIcon™ Digital Humidity/Temperature Sensors

## **WARNING**

### **PERSONAL INJURY**

DO NOT USE these products as safety or emergency stop devices or in any other application where failure of the product could result in personal injury.

**Failure to comply with these instructions could result in death or serious injury.**

## **WARRANTY/REMEDY**

Honeywell warrants goods of its manufacture as being free of defective materials and faulty workmanship. Honeywell's standard product warranty applies unless agreed to otherwise by Honeywell in writing; please refer to your order acknowledgement or consult your local sales office for specific warranty details. If warranted goods are returned to Honeywell during the period of coverage, Honeywell will repair or replace, at its option, without charge those items it finds defective. **The foregoing is buyer's sole remedy and is in lieu of all other warranties, expressed or implied, including those of merchantability and fitness for a particular purpose. In no event shall Honeywell be liable for consequential, special, or indirect damages.**

While we provide application assistance personally, through our literature and the Honeywell web site, it is up to the customer to determine the suitability of the product in the application.

Specifications may change without notice. The information we supply is believed to be accurate and reliable as of this printing. However, we assume no responsibility for its use.

## **WARNING**

### **MISUSE OF DOCUMENTATION**

- The information presented in this technical note is for reference only. DO NOT USE this document as a product installation guide.
- Complete installation, operation, and maintenance information is provided in the instructions supplied with each product.

**Failure to comply with these instructions could result in death or serious injury.**

## **SALES AND SERVICE**

Honeywell serves its customers through a worldwide network of sales offices, representatives and distributors. For application assistance, current specifications, pricing or name of the nearest Authorized Distributor, contact your local sales office or:

**E-mail:** [info.sc@honeywell.com](mailto:info.sc@honeywell.com)

**Internet:** [www.honeywell.com/sensing](http://www.honeywell.com/sensing)

### **Phone and Fax:**

Asia Pacific	+65 6355-2828 +65 6445-3033 Fax
Europe	+44 (0) 1698 481481 +44 (0) 1698 481676 Fax
Latin America	+1-305-805-8188 +1-305-883-8257 Fax
USA/Canada	+1-800-537-6945 +1-815-235-6847 +1-815-235-6545 Fax

Sensing and Control  
Honeywell  
1985 Douglas Drive North  
Golden Valley, MN 55422  
[www.honeywell.com/sensing](http://www.honeywell.com/sensing)

009062-3-EN  
June 2012  
Copyright © 2012 Honeywell International Inc. All rights reserved.

# Honeywell